

LED Driver

LNE-150W Series / LNE-□V150W□□□



LNE

Highlights & Features

- North American and International AC voltage options
- Up to 94.0% efficiency
- 6kV common mode & 4kV differential mode surge immunity
- Active PFC. Meets IEC/EN 61000-3-2, Class C
- Adjustable voltage & current; dimming option available
- IP65 or IP67 assembly for indoor and outdoor applications

Safety Standards



CB Certified for worldwide use

Model Number: LNE-□V150W□□□
Unit Weight: 1.04 kg (2.29 lb)
Dimensions (L x W x D): 228 x 68 x 38.8 mm
 (8.98 x 2.68 x 1.53 inch)

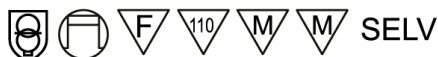

Package Type

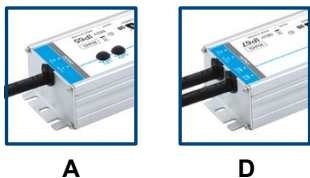

A

D

General Description

Delta LNE series of LED drivers comes with different combinations of features to suit different application requirements and energy optimization needs. Options include externally adjustable output voltage and current levels, and adjustment of LED brightness via 3-way built-in dimming function. All models in the LNE series come with a full corrosion resistant aluminum casing, major international safety certifications and are compliant with EN55015 immunity/Emissions/Harmonic requirements. The products are designed and rigorously tested to work in various indoor and outdoor LED lighting conditions. High surge immunity (common mode: 6kV, differential mode: 4kV), MTBF > 700,000hrs and compliance to IP65/IP67, all make the Delta LNE series an essential part of an energy efficient LED lighting power solution for both indoor and outdoor applications.

Model Information

LNE LED Driver

Model Number	Input Voltage Range	Rated Output Voltage	Rated Output Current
LNE-12V150W□□□	90-305Vac (LNE-□V150W□A□) 90-264Vac (LNE-□V150W□C□)	12Vdc	12.50A
LNE-24V150W□□□		24Vdc	6.30A
LNE-36V150W□□□		36Vdc	4.20A
LNE-48V150W□□□		48Vdc	3.20A
LNE-54V150W□□□		54Vdc	2.80A

Model Numbering

LN	E -	□V	150W	□	□	□
LED Driver	Product Series E – High efficiency and PFC	Output Voltage 12V 24V 36V 48V 54V	Output Power (150W series model)	Package Type A – IP65 with potentiometers to adjust output voltage & constant current level D – IP67 with dimming cable to adjust constant current level	Safety Approval A – UL approval C – ENEC, CE, PSE and CCC approval	Variable A – Delta standard

LED Driver

LNE-150W Series / LNE-□V150W□□□

Specifications

Model Number	LNE-12V150W□	LNE-24V150W□	LNE-36V150W□	LNE-48V150W□	LNE-54V150W□
--------------	--------------	--------------	--------------	--------------	--------------

Input Ratings / Characteristics

Nominal Input Voltage	100-277Vac (LNE-□V150W□A□) 100-240Vac (LNE-□V150W□C□)					
Input Voltage Range*	90-305Vac (LNE-□V150W□A□) 90-264Vac (LNE-□V150W□C□)					
Nominal Input Frequency	50-60Hz					
Input Frequency Range	47-63Hz					
Input Current	1.80A max. @ 115Vac, 0.85A max. @ 230Vac, 0.80A max. @ 277Vac					
Efficiency at 100% Load	115Vac	89.0% typ.	91.5% typ.	91.0% typ.	91.5% typ.	91.5% typ.
	230Vac	91.5% typ.	93.0% typ.	93.5% typ.	94.0% typ.	94.0% typ.
	277Vac	91.0% typ.	93.0% typ.	93.0% typ.	94.0% typ.	94.0% typ.
Max Inrush Current (Cold Start)	65A typ. @ 230Vac					
Power Factor at 100% Load	0.98 typ. @ 115Vac 0.95 typ. @ 230Vac 0.92 typ. @ 277Vac					
Total Harmonic Distortion	< 20% @ 115Vac/60 Hz & 230Vac/50 Hz (≥ 60% load) < 20% @ 277Vac/50 Hz (≥ 75% load)					
Leakage Current	< 0.75mA @ 305Vac (LNE-□V150W□A□) < 0.75mA @ 264Vac (LNE-□V150W□C□)					

* Output power is de-rated at low input voltage. Please refer to Fig. 2 on page 10.

LED Driver

LNE-150W Series / LNE-□V150W□□□

Power Factor VS Output Load

LNE-12V150W□

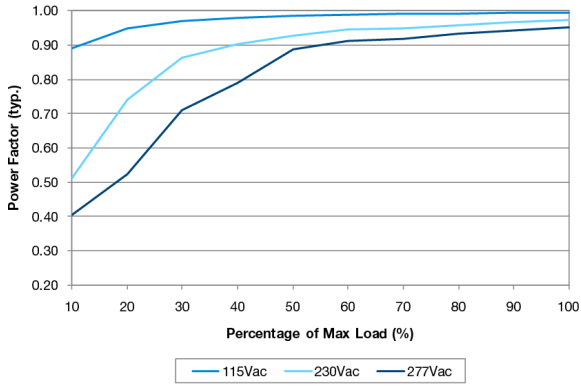

LNE-24V150W□

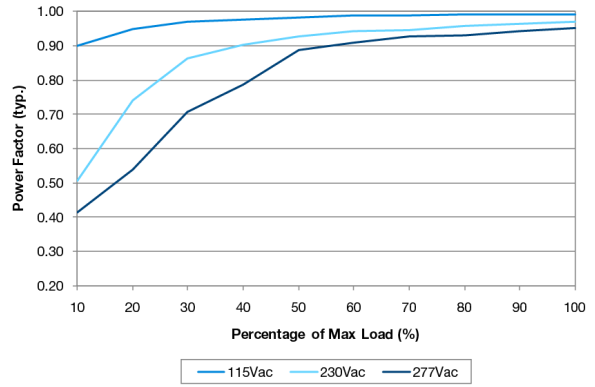

LNE-36V150W□

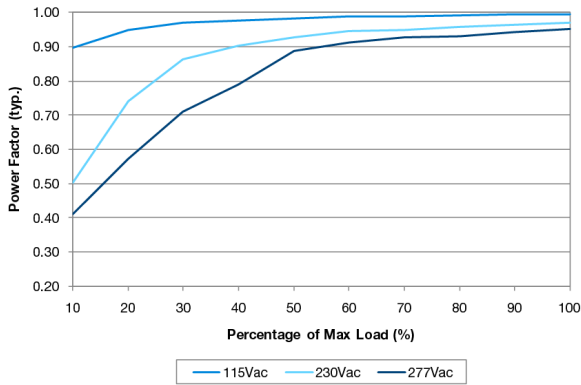

LNE-48V150W□

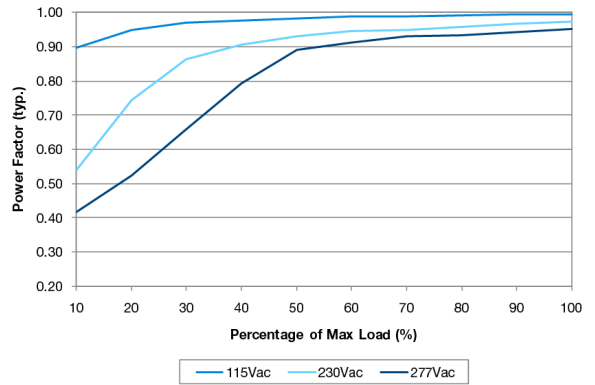

LNE-54V150W□

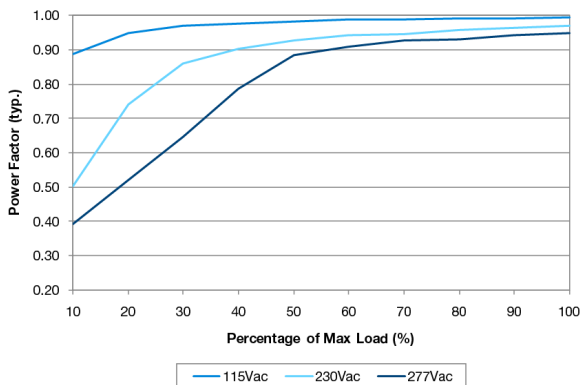

LED Driver

LNE-150W Series / LNE-□V150W□□□

Efficiency VS Output Load at Nominal Output Voltage

LNE-12V150W□

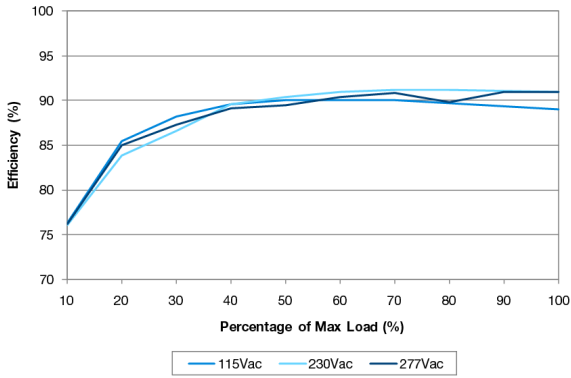

LNE-24V150W□

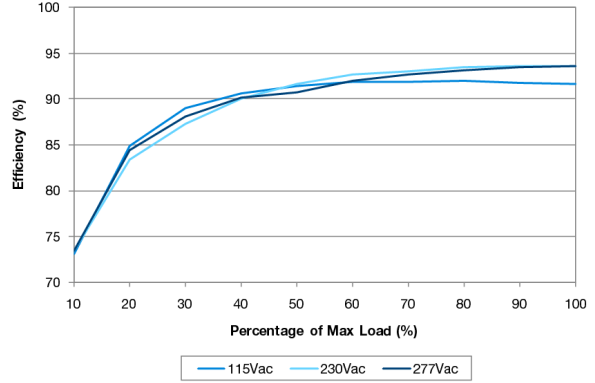

LNE-36V150W□

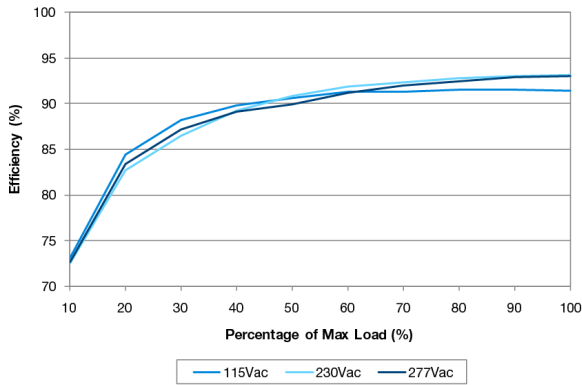

LNE-48V150W□

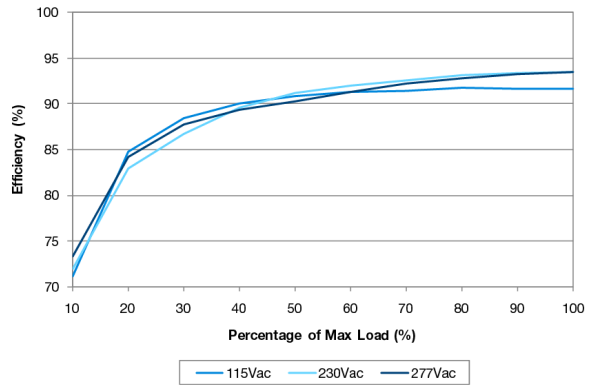

LNE-54V150W□

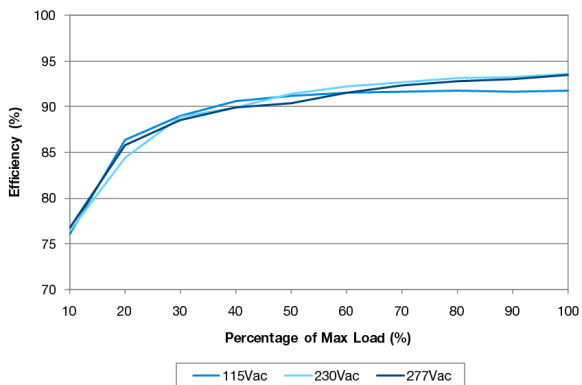

LED Driver**LNE-150W Series / LNE-□V150W□□□**

Model Number	LNE-12V150W□	LNE-24V150W□	LNE-36V150W□	LNE-48V150W□	LNE-54V150W□
--------------	--------------	--------------	--------------	--------------	--------------

Output Ratings / Characteristics*

Nominal Output Voltage	12Vdc	24Vdc	36Vdc	48Vdc	54Vdc
LED System Voltage Range in CC Mode	6-12Vdc	12-24Vdc	18-36Vdc	24-48Vdc	27-54Vdc
Output Voltage Adjustment Range**	10.8-13.5V	22.0-27.0V	33.0-40.0V	43.0-53.0V	49.0-58.0V
Nominal Output Current	12.5A	6.3A	4.2A	3.2A	2.8A
Output Current Adjustment Range**	6.25-12.50A	3.15-6.30A	2.10-4.20A	1.60-3.20A	1.40-2.80A
Output Power	150W	151.2W	151.2W	153.6W	151.2W
Line Regulation @ 90-305Vac (LNE-□V150W□A□) @ 90-264Vac (LNE-□V150W□C□)	± 0.5%				
Load Regulation (0-95% load) @ 90-305Vac (LNE-□V150W□A□) @ 90-264Vac (LNE-□V150W□C□)	± 2.0%	± 1.0%	± 1.0%	± 0.5%	± 0.5%
PARD*** (20MHz)	< 150mVpp	< 150mVpp	< 200mVpp	< 200mVpp	< 200mVpp
Rise Time	< 50ms @ 115Vac & 230Vac & 277Vac				
Start-up Time	1000ms typ. @ 115Vac (100% load) 500ms typ. @ 230Vac & 277Vac (100% load)				
Hold-up Time	16ms typ. @ 115Vac & 230Vac & 277Vac (100% load)				
Dynamic Response (Overshoot & Undershoot O/P Voltage)	± 5% @ 0-90% load, @ 115Vac & 230Vac & 277Vac (Slew Rate: 0.1A/μS)				

* For power de-rating from 60°C to 70°C, see power de-rating at Fig.1 on page 10.

** For LNE-□V150WA□□ package type only.

*** PARD is measured with an AC coupling mode, and in parallel with 0.1μF ceramic capacitor & 47μF electrolytic capacitor.

LED Driver

LNE-150W Series / LNE-□V150W□□□

Model Number	LNE-12V150W□	LNE-24V150W□	LNE-36V150W□	LNE-48V150W□	LNE-54V150W□
--------------	--------------	--------------	--------------	--------------	--------------

Mechanical

Casing		Aluminium			
Dimensions (L x W x D)		228 x 68 x 38.8 mm (8.98 x 2.68 x 1.53 inch)			
Unit Weight		1.04 kg (2.29 lb)			
Cooling System		Convection			
Wire	Input	LNE-□V150W□C□	H05RN-F3G1.0mm ²	Line: Brown, Neutral: Blue, PE: Green/Yellow	
		LNE-□V150W□A□	SJTW 18AWGX3C	Line: Brown, Neutral: Blue, PE: Green/Yellow	
	Output	LNE-□V150W□C□	H07RN-F2x1.5mm ²	Positive: Red, Negative: Black	
		LNE-□V150W□A□	SJTW 14AWGX2C	Positive: Red, Negative: Black	
	Dimming	LNE-□V150W□C□	H05RN-F2x1.0mm ²	Positive: White, Negative: Blue	
		LNE-□V150W□A□	SJTW 18AWGX2C	Positive: White, Negative: Blue	
Noise (1 Meter from power supply)		Sound Pressure Level (SPL) < 25dbA			

Environment

Surrounding Air Temperature	Operating	-40°C to +70°C
	Storage	-40°C to +85°C
Power De-rating	> 60°C de-rate power by 4% / °C < 100Vac de-rate power by 2% / Vac	
Operating Humidity	5 to 95% RH (Non-Condensing)	
Operating Altitude	0 to 3,000 Meters (9,840 ft.)	
Shock Test	Non-Operating	IEC 60068-2-27, Half Sine Wave: 50G for a duration of 11ms, 3 shocks for each 3 directions
Vibration	Non-Operating	IEC 60068-2-6, Random: 5Hz to 500Hz (2.09G); 20 min per axis for all X, Y, Z direction
Pollution Degree	2	
Location Ratings (Included in safety approvals)	Dry rating (LNE-□V150WA□□) Dry, damp ratings (LNE-□V150WD□□)	

Protections

Overvoltage	13.8-16.8V, Latch Mode	27.6-33.6V, Latch Mode	41.4-50.4V, Latch Mode	55.2-67.2V, Latch Mode	62.1-75.6V, Latch Mode
Overload / Overcurrent	95-108% of rated load current, constant current limit Auto-Recovery when the fault is removed				
Over Temperature	Hiccup Mode, Auto-Recovery when the fault is removed				
Short Circuit	Constant current limit, Auto-Recovery when the fault is removed				
Degree of Protection	IP65 (LNE-□V150WA□□) IP67 (LNE-□V150WD□□)				
Protection Against Shock	Class I with PE* connection				

*PE: Primary Earth

LED Driver

LNE-150W Series / LNE-□V150W□□□

Model Number	LNE-12V150W□	LNE-24V150W□	LNE-36V150W□	LNE-48V150W□	LNE-54V150W□
--------------	--------------	--------------	--------------	--------------	--------------

Reliability Data

MTBF	> 700,000 hrs. per Telcordia SR-332 at Input: 115Vac, Output: 100% load, Ta: 25°C
Expected Cap Life Time	10 years (115Vac & 230Vac, 50% load @ 40°C)

Safety Standards / Directives

Electrical Safety	CB scheme	LNE-□V150W□□□: IEC 61347-1, IEC 61347-2-13
	ENEC	EN 61347-1, EN 61347-2-13, EN 62384
	CCC	GB19510.1, GB19510.14
	PSE	J61347-1, J61347-2-13
	UL/cUL recognized	LNE-□V150W□A□: UL 8750 and CAN/CSA C22.2 No. 60950-1
CE		In conformance with EMC Directive 2014/30/EU and Low Voltage Directive 2014/35/EU (LNE-□V150W□□□)
Galvanic Isolation	Input to Output	3.85kVac
	Input to Ground	2.0kVac
	Output to Ground	1.5kVac

EMC

Emissions (CE & RE)		CISPR 15, EN 55015, GB17743 Compliance to CISPR 32, EN 55032, FCC Title 47: Class B
Immunity		EN 61547, Compliance to EN 55024
Electrostatic Discharge	IEC 61000-4-2	Level 4 Criteria B ²⁾ Air Discharge: 15kV Contact Discharge: 8kV
		Level 3 Criteria A ¹⁾ Air Discharge: 8kV Contact Discharge: 6kV
Radiated Field	IEC 61000-4-3	Level 3 Criteria A ¹⁾ 80MHz-1GHz, 10V/M with 1kHz tone / 80% modulation
Electrical Fast Transient / Burst	IEC 61000-4-4	Level 3 Criteria A ¹⁾ 2kV
Surge	IEC 61000-4-5	Level 5 Criteria B ²⁾ Common Mode ³⁾ : 6kV Differential Mode ⁴⁾ : 4kV
Conducted	IEC 61000-4-6	Level 3 Criteria A ¹⁾ 150kHz-80MHz, 10Vrms
Power Frequency Magnetic Fields	IEC 61000-4-8	Level 3 Criteria A ¹⁾ 10A/Meter
Voltage Dips	IEC 61000-4-11	100% dip, 0.5 cycle, Criteria A ¹⁾ 70% dip, 10 cycle, Criteria B ²⁾ @ 100Vac & Criteria A ¹⁾ @ 230Vac
Harmonic Current Emission		IEC/EN 61000-3-2, Class C; GB17625.1 (THD conditions: 115Vac & 230Vac @ ≥ 60% load & 277Vac @ ≥ 75% load)
Voltage Fluctuation and Flicker		IEC/EN 61000-3-3

1) Criteria A: Normal performance within the specification limits

2) Criteria B: Temporary degradation or loss of function which is self-recoverable

3) Asymmetrical: Common mode (Line to earth)

4) Symmetrical: Differential mode (Line to line)

LED Driver

LNE-150W Series / LNE-□V150W□□□

Block Diagram

LNE-□V150WA□□

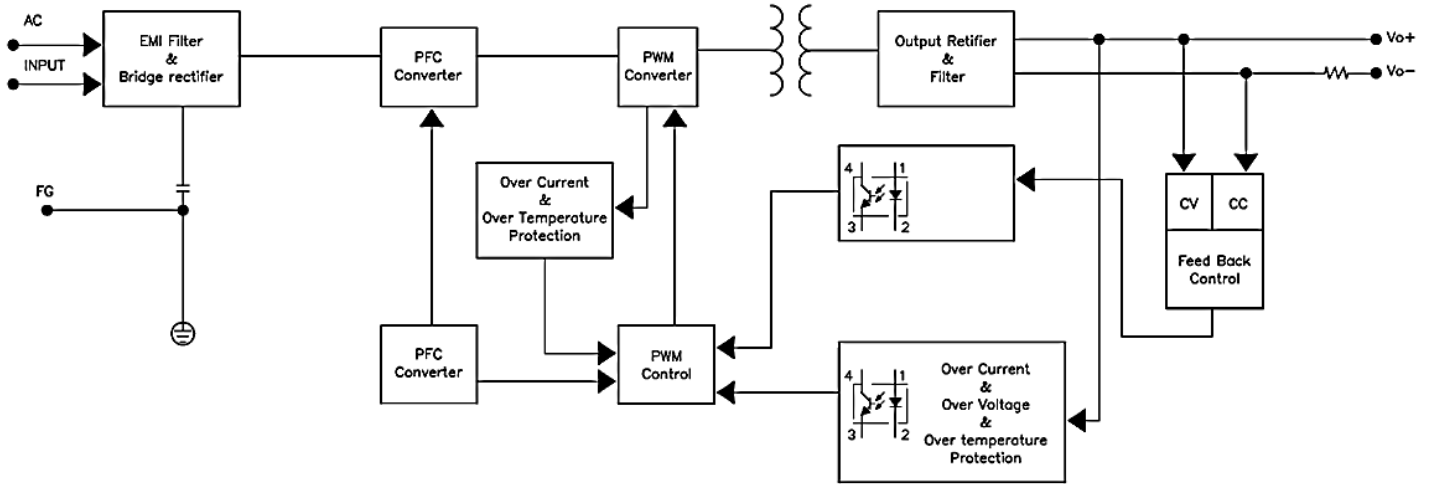

LNE-□V150WD□□

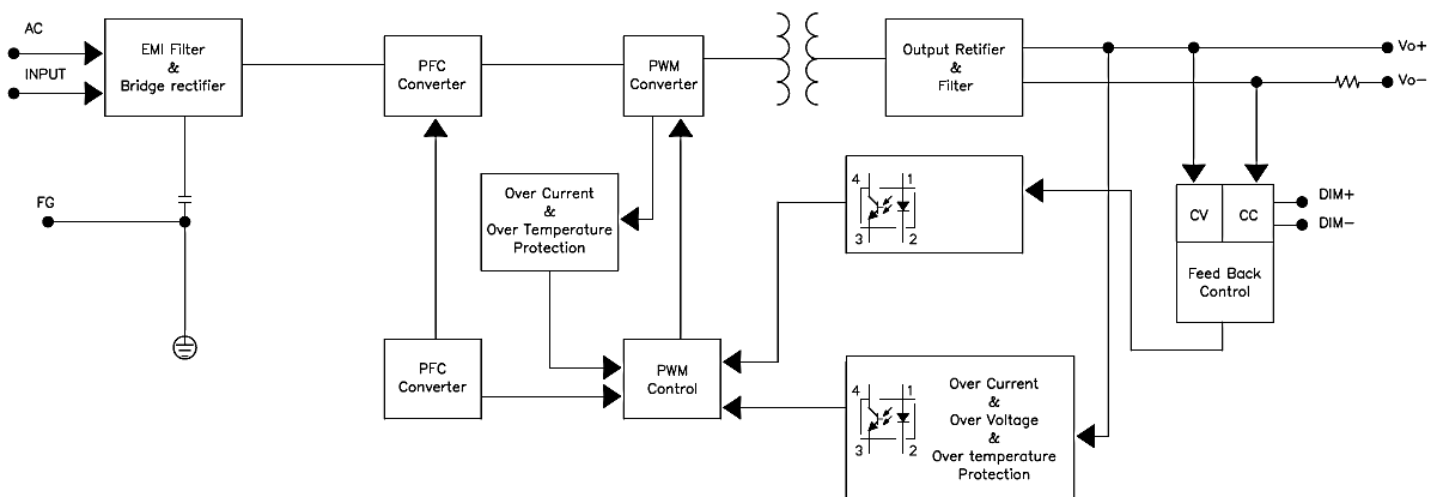

LED Driver

LNE-150W Series / LNE-□V150W□□□

Dimensions

L x W x D: 228 x 68 x 38.8 mm [8.98 x 2.68 x 1.53 inch]

LNE-□V150WA□□

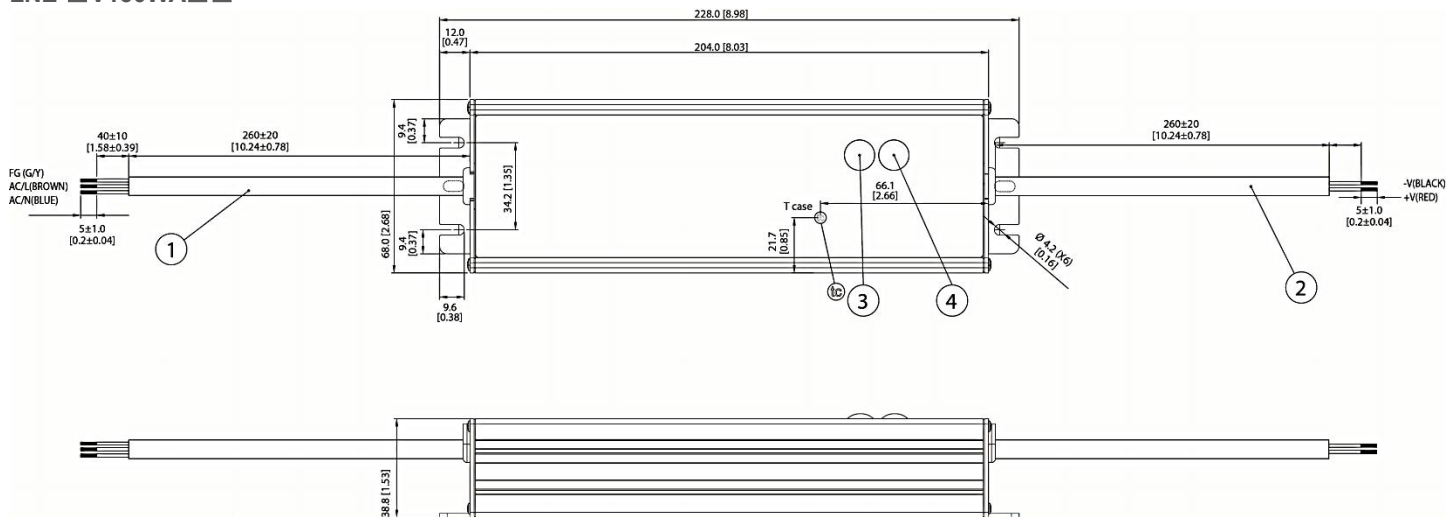

LNE-□V150WD□□

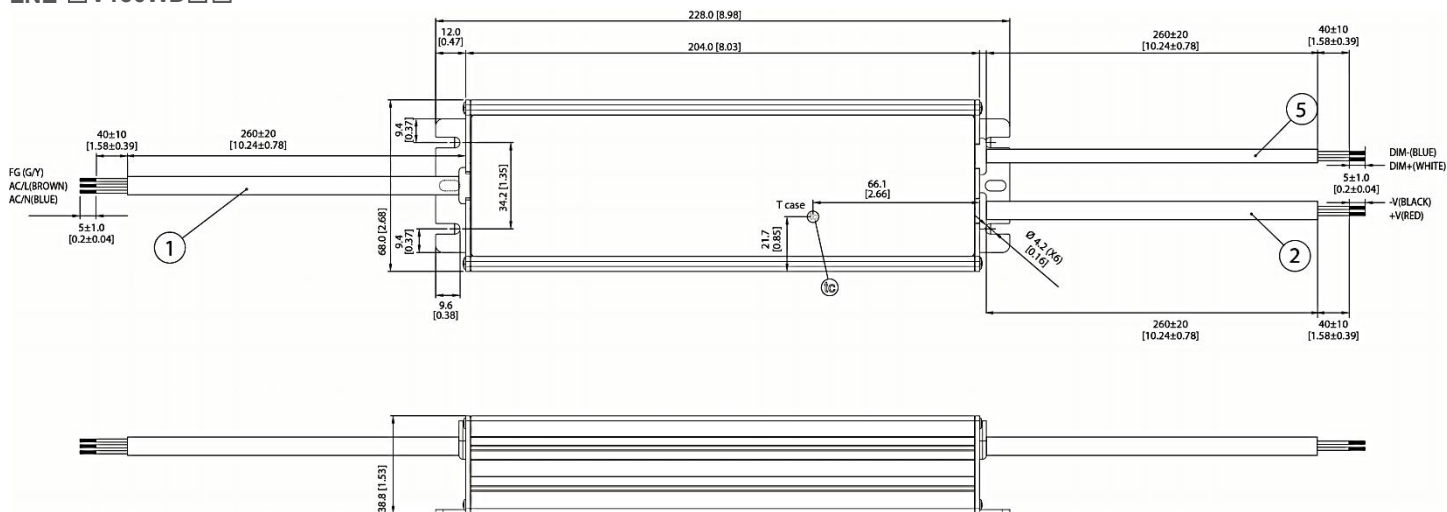

Item	Device Description
1	Input cable
2	Output cable
3	Constant voltage adjustment potentiometer
4	Constant current adjustment potentiometer
5	Dimming Cable
tc	T case (tc): Temperature hot spot location on case. The temperature at this location will not exceed 85°C when used in accordance to conditions in this data sheet.

LED Driver

LNE-150W Series / LNE-□V150W□□□

Engineering Data

Output Load De-rating VS Surrounding Air Temperature

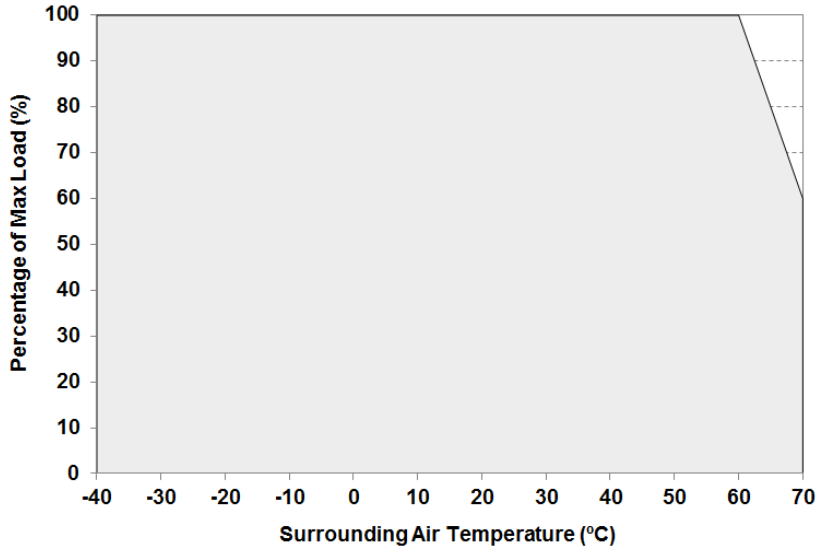

Fig. 1 De-rating for All Mounting Orientation (All Models)
 > 60°C de-rate power by 4% / °C

Note

1. Power supply components may degrade, or be damaged, when the power supply is continuously used outside the shaded region, refer to the graph shown in Fig. 1.
2. If the output capacity is not reduced when the surrounding air temperature >60°C, the device will run into Over Temperature Protection. When activated, the output voltage will go into bouncing mode and will recover when the surrounding air temperature is lowered or the load is reduced as far as necessary to keep the device in working condition.
3. Depending on the surrounding air temperature and output load delivered by the power supply, the device can be very hot!

Output Load De-rating VS Input Voltage

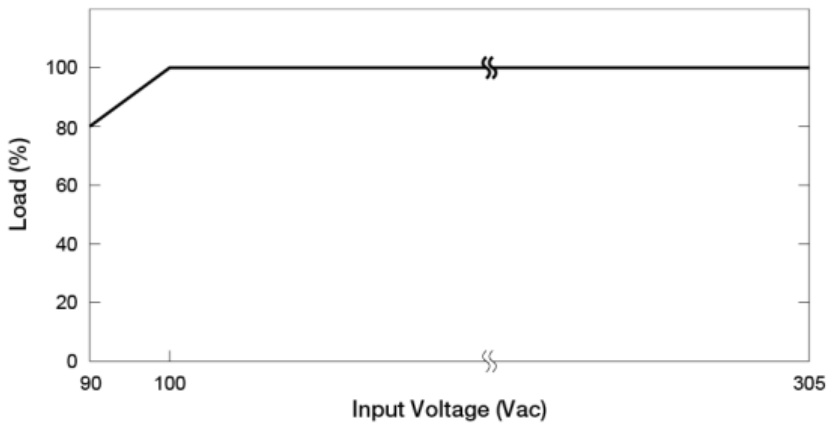

Fig. 2 De-rating for Low Input Voltage (All Models)
 < 100Vac de-rate power by 2% / Vac

- No output power de-rating for the input voltage from:-
 100Vac to 305Vac (LNE-□V150W□A□),
 100Vac to 264Vac (LNE-□V150W□C□)

LED Driver

LNE-150W Series / LNE-□V150W□□□

Assembly & Installation

Mounting holes for LED driver assembly onto the mounting surface.

<p>Ⓐ, Ⓑ</p>	<p>Mounting holes for the LED driver (device). There are 3 mounting holes at either end of the device (locations Ⓐ and Ⓑ in Fig. 3). The device shall be mounted using a minimum of 2 out of the 3 mounting holes on both sides. Mounting shall be done using M4 screws with minimum length of 5mm. If customer's end system or panel where the device is mounted does not have screw threads, please use suitable metal screw and nut to secure the device.</p>
<p>Ⓒ</p>	<p>Surface Ⓒ belongs to customer's end product or panel where the device is mounted. The device should be mounted on a sturdy heat conducting surface with minimum of 4 mounting holes, as detailed above.</p>

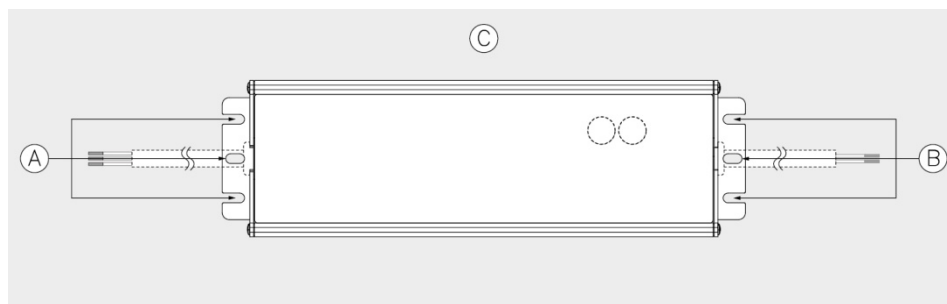

Fig. 3 Mounting Hole Locations

Safety Instructions

- ALWAYS switch mains of input power OFF before connecting and disconnecting the input voltage to the device. If mains are not turned OFF, there is risk of explosion / severe damage.
- To guarantee sufficient convection cooling, keep a distance of 50mm above and lateral distance to nearby objects.
- The device is not recommended to be placed on low thermal conductive surfaces. For example, plastics.
- DO NOT insert any objects into the device.
- Note that the enclosure of the device can become very hot depending on the surrounding air temperature and output load connected to the device. Risk of burns!
- If the device is continuously operating outside the shaded region shown in Fig. 1. The device may be damaged or degraded.
- When the PE (Green/Yellow) wire of the device is not connected, the device must be installed on a metal plate that has a PE connection.
- The current rating for the all wires, connected to the input and output wires of the device, must be rated higher than or equal to the input and output current of the power supply. Please refer to the product specifications.
- For device with dimming function, always ensure the dimming control is working properly.
- Please ensure the correct tools are used for all adjustments and installations of the device. If in doubt, please consult your local Delta support or contact us via info@DeltaPSU.com.

LED Driver

LNE-150W Series / LNE-□V150W□□□

Functions

Start-up Time

The time required for the output voltage to reach 90% of its final steady state set value, after the input voltage is applied.

Rise Time

The time required for the output voltage to change from 10% to 90% of its final steady state set value.

Hold-up Time

Time between the collapse of the AC input voltage, and the output falling to 95% of its steady state set value.

■ Graph illustrating the Start-up Time, Rise Time, and Hold-up Time

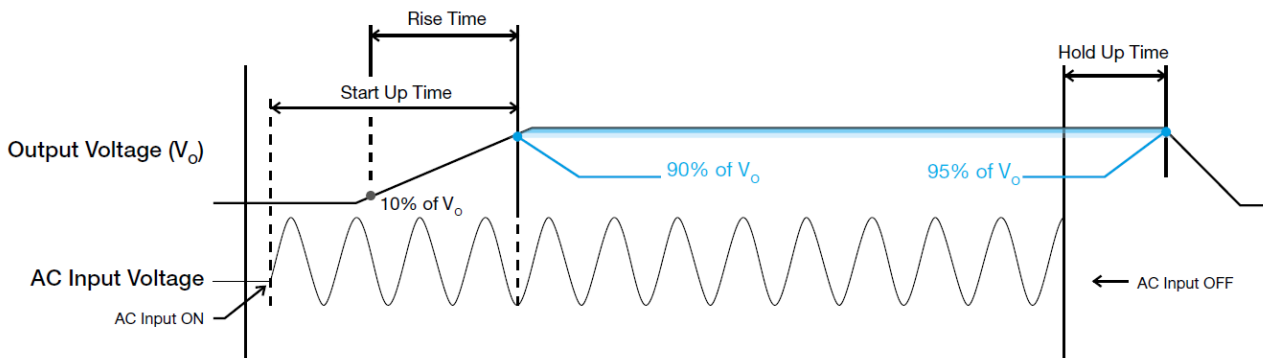

Inrush Current

Inrush current is the peak, instantaneous, input current measured and, occurs when the input voltage is first applied. For AC input voltages, the maximum peak value of inrush current will occur during the first half cycle of the applied AC voltage. This peak value decreases exponentially during subsequent cycles of AC voltage.

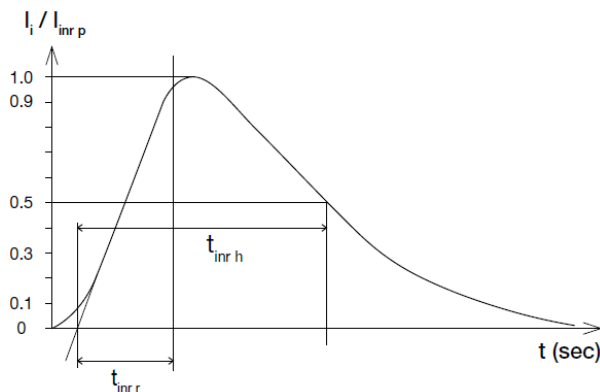

Dynamic Response (For CV Operation Only)

The power supply output voltage will remain within $\pm 5\%$ of its steady state value, when subjected to a dynamic load from 0 to 100% of its rated current.

■ 90% Duty / 1 KHz

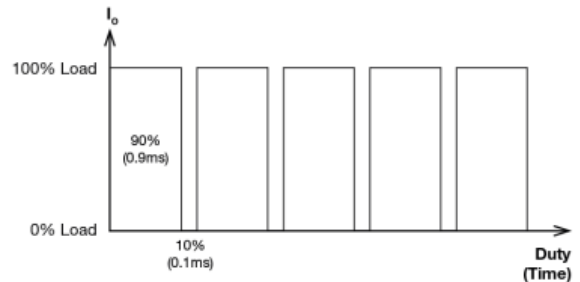

■ 90% Duty / 120 Hz

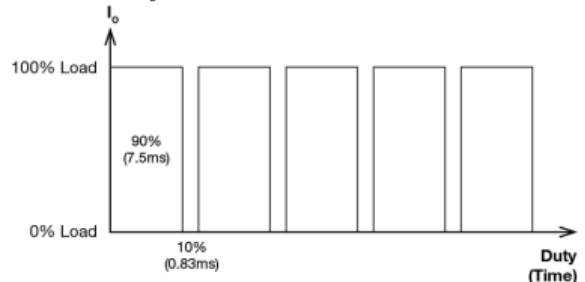

LED Driver

LNE-150W Series / LNE-□V150W□□□

Operating Methods of LED Modules-CV and CC Operation

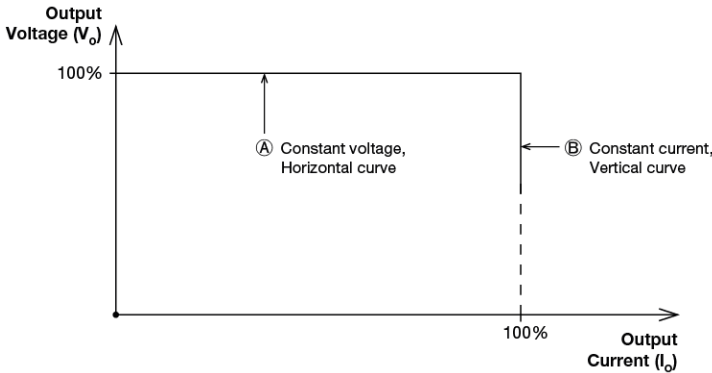

A typical LED power supply is able to either work in "constant voltage mode (CV) or constant current mode (CC)" to drive the LEDs. Delta's LNE drivers integrate CV+CC characteristics; so operation in CV mode (with external LED driver), in region (A) or CC mode (direct drive, at area (B)).

In the constant current region, the highest voltage at the output of the driver depends on the configuration of the end systems.

Should there be any compatibility issues or other questions with these adjustment methods, please contact with Delta.

Dimming Operations

This operation is available for LNE-□V150WD□□ only.

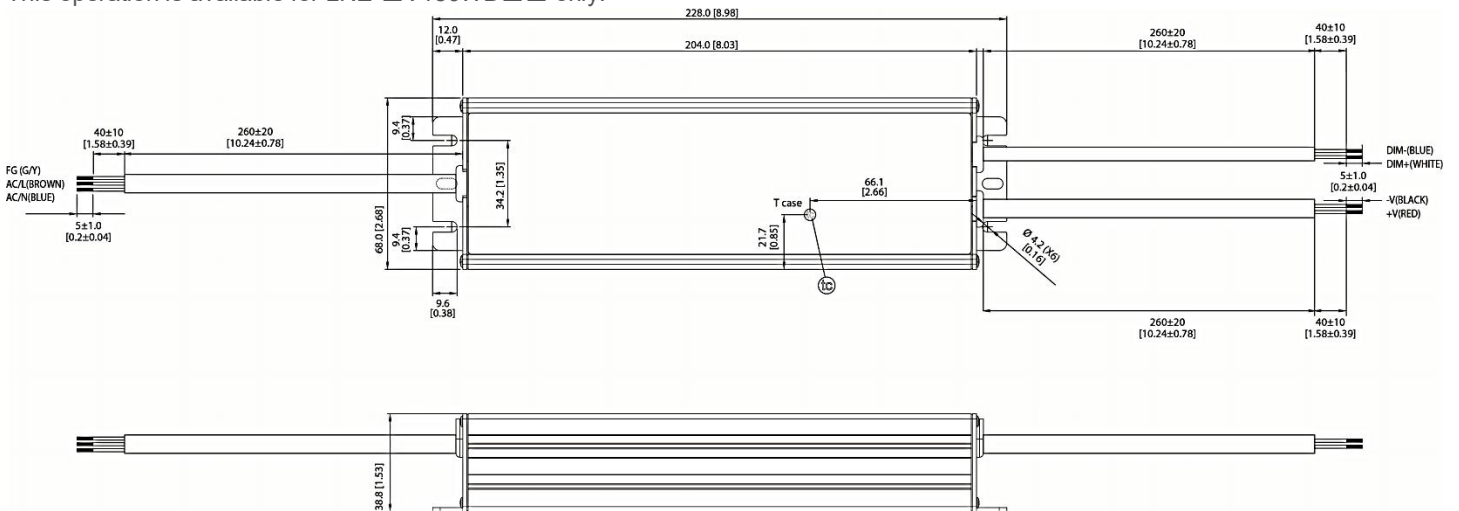

The Dimming connection diagram for turning the lighting fixture ON/OFF can be configured as below.

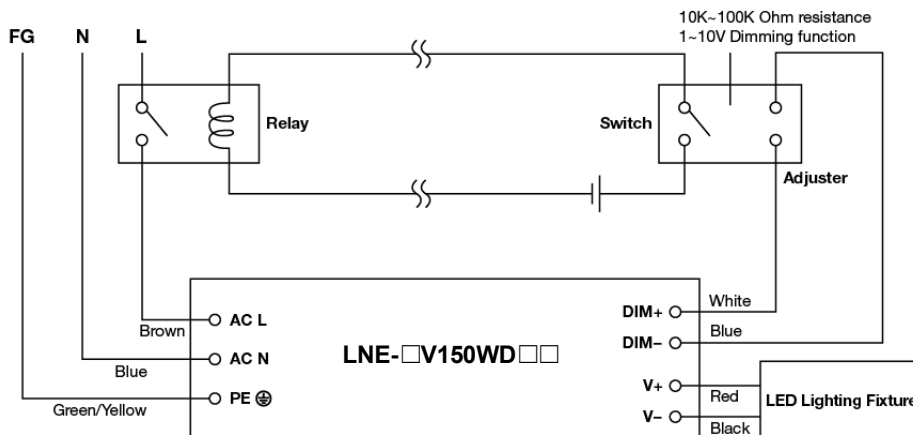

Please refer an example of reference configuration as follows.

1. Built-in 3 in 1 dimming function, IP67 rated. Output constant current level can be adjusted through output cable by connecting a resistance or 1~10Vdc or 10V PWM signal between DIM+ and DIM-.
2. The LED lighting fixture can be turned ON/OFF by the switch.

LED Driver

LNE-150W Series / LNE-□V150W□□□

3. Please DO NOT connect "DIM-" to "V-".
4. Reference resistance value for output current adjustment (Typical).

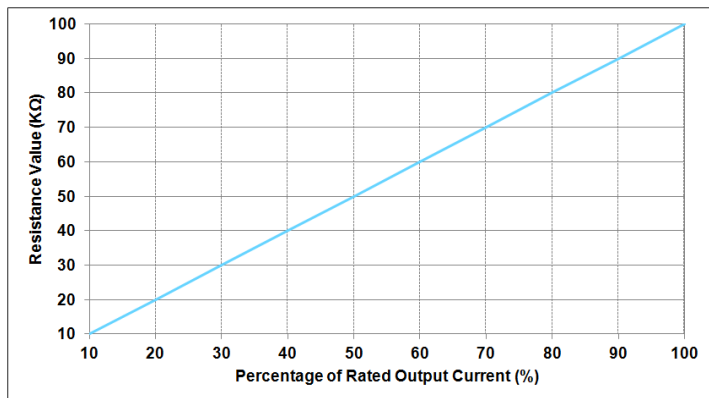

5. 1 ~ 10V dimming function for output current adjustment (Typical).

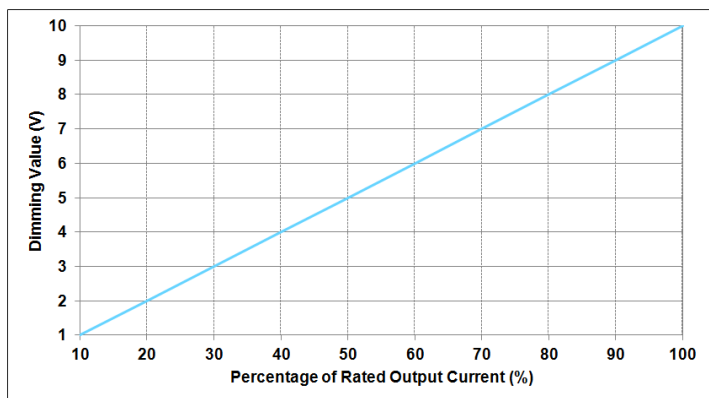

6. 10V PWM signal for output current adjustment is also possible. For additional information, please contact your Delta sales representative.
7. Please note that LNE-□V150WD□□ can't turn the lighting fixture completely off (totally dark) by using any of these dimming adjustment methods. To completely turn off the lighting fixture, the input AC voltage must be removed. See illustration on previous page.

External Input Protection Device

The unit is protected at the L pin, with an internal fuse that cannot be replaced. The power supply has been tested and approved on 20A branch circuits without additional protection device. An external protection device is only required if the supplying branch has an ampacity greater than above. Thus, if an external protective device is necessary, a 20 Ampere C-characteristic circuit breaker can be utilized.