

LED Driver

LNE-600W Series / LNE-□V600WBGA

LNE

Highlights & Features

- International AC input voltage with worldwide certified cable use
- Up to 96.0% efficiency
- 10kV common mode & 10kV differential mode surge immunity
- IEC/EN 61000-4-2, Level 4 Criteria A, 15kV air discharge, 8kV contact discharge
- IP67 mechanical design for indoor and outdoor applications

Safety Standards



CB Certified for worldwide use

Model Number:	LNE-□V600WBGA
Unit Weight:	3.15 kg (6.94 lb)
Dimensions (L x W x D):	307.5 x 114.3 x 50.8 mm (12.11 x 4.5 x 2 inch)



General Description

Delta Electronics' range of 600W LED drivers comes rigorously tested for both indoor and outdoor lighting requirement. As part of the LNE series, the 600W design can withstand high surge immunity single pulse of 10kV for both common and differential mode. The 600W LED driver meets IEC 61000-4-2 Level 4 Criteria A, and IEC 61000-4-5 (common 6KV, differential 4KV). The products offer a wide operating temperature from -40°C to +70°C with convection cooling. The efficiency levels up to 96% and IP67 design makes the Delta LNE series an essential part of an energy efficient LED lighting power solution for sports arena lighting and agricultural lighting.

Model Information

LNE LED Driver

Model Number	Input Voltage Range	Rated Output Voltage	Rated Output Current
LNE-24V600WBGA	100-277Vac	24Vdc	25.00A
LNE-36V600WBGA		36Vdc	16.70A
LNE-48V600WBGA		48Vdc	12.50A
LNE-54V600WBGA		54Vdc	11.11A

Model Numbering

LN	E –	□V	600W	B	G	A
LED Driver	Product Series E – High efficiency and PFC	Output Voltage 24V 36V 48V 54V	Output Power (600W series model)	Package Type B – IP67 without dimming cable and potentiometers	Safety Approval G – UL, ENEC, CE approval	Variable A – Delta standard

LED Driver

LNE-600W Series / LNE-□V600WBGA

Specifications

Model Number	LNE-24V600W	LNE-36V600W	LNE-48V600W	LNE-54V600W
--------------	-------------	-------------	-------------	-------------

Input Ratings / Characteristics

Nominal Input Voltage	120-240Vac				
Input Voltage Range* ¹	100-277Vac				
Nominal Input Frequency	50-60 Hz				
Input Frequency Range	47-63 Hz				
Input Current	7A max. @ 120Vac, 3.3A max. @ 230Vac, 2.9A max. @ 277Vac				
Efficiency at 100% load	230Vac	95.0% typ	95.5% typ.	96.0% typ	96.0% typ
	277Vac	95.0% typ	95.5% typ.	96.0% typ	96.0% typ
No load Consumption* ²	< 0.5W @ 230Vac				
Max Inrush Current (Cold Start)	65A typ. @ 230Vac				
Power Factor at 100% load	0.98 typ. @ 120Vac				
	0.95 typ. @ 230Vac				
	0.93 typ. @ 277Vac				
Total Harmonic Distortion	< 20% @ 120Vac/60Hz & 230Vac/50Hz (≥ 50% load) < 20% @ 277Vac/50Hz (≥ 75% load)				
Leakage Current	< 0.75mA @ 277Vac				
Max. Number of LED drivers with 16A Circuit Breaker	1 unit for 16A CB (B type) / 2 units for 20A CB (C type)				

*1 Output power is de-rated for input voltage lower than 120 Vac. Please refer to Fig. 2 on page 7.

*2 Test only 5V aux output, main power is off.

Output Ratings / Characteristics*³

Nominal Output Voltage	24Vdc	36Vdc	48Vdc	54Vdc
LED System Voltage Range in CC Mode	12-24Vdc	18-36Vdc	24-48Vdc	54-27Vdc
Nominal Output Current	25A	16.7A	12.5A	11.11A
Output Power	600W	601.2W	600W	600W
Line Regulation	± 0.5%			
Load Regulation (0-95% load)	± 1%			
PARD* ⁴ (20 MHz)	150mV typ	250mV typ	250mV typ	300mV typ
Rise Time	< 50ms @ 120Vac & 230Vac & 277Vac			
Start-up Time	< 1000ms @ 120Vac			
	< 500ms @ 230Vac			
Hold-up Time	16ms typ. @ 120Vac & 230Vac & 277Vac (100% load)			
Dynamic Response (Overshoot & Undershoot O/P Voltage)	± 5% @ 0-90% load , @ 120Vac & 230Vac & 277Vac (Slew Rate: 0.1A/μS)			
Auxiliary Output	5V / 0.5A			

*3 For power de-rating, see power de-rating at Fig.1 on page 7

*4 PARD is measured with an AC coupling mode, and in parallel with 0.1μF ceramic capacitor & 47μF electrolytic capacitor.

LED Driver

LNE-600W Series / LNE-□V600WBGA

Efficiency VS Output Load

LNE-24V600WBGA

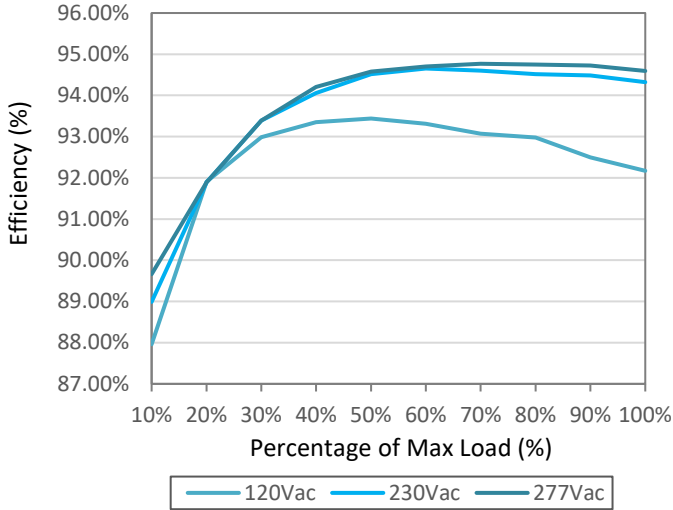

LNE-36V600BGA

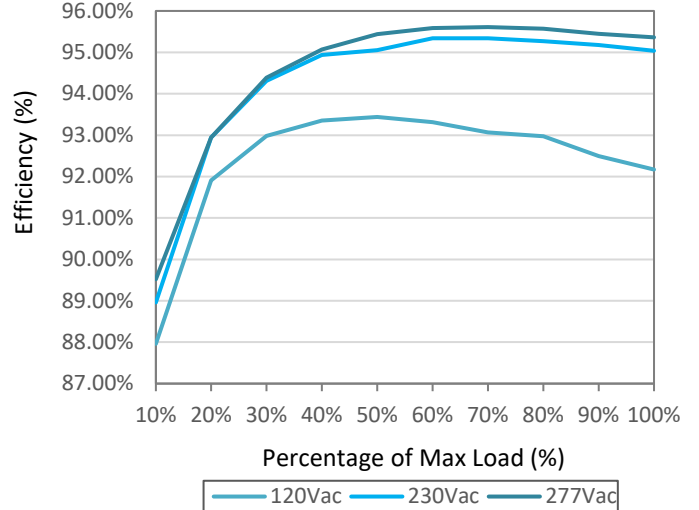

LNE-48V600WBGA

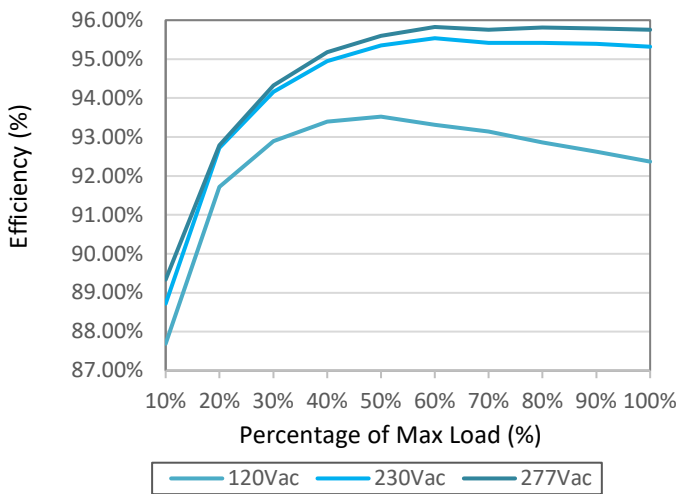

LNE-54V600BGA

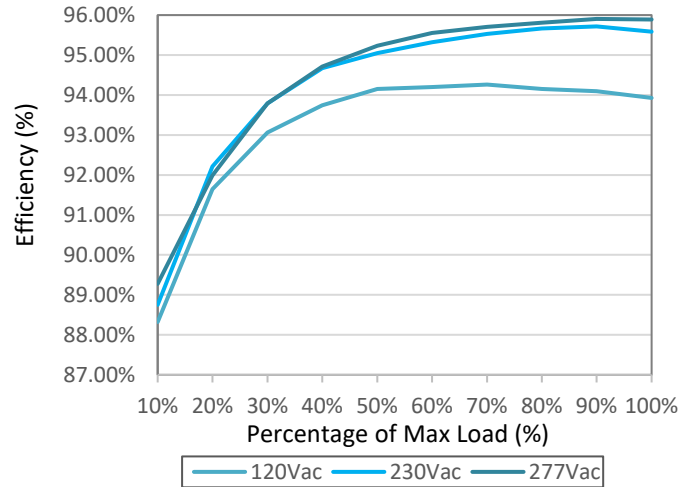

LED Driver

LNE-600W Series / LNE-□V600WBGA

Power Factor VS Output Load

LNE-24V600WBGA

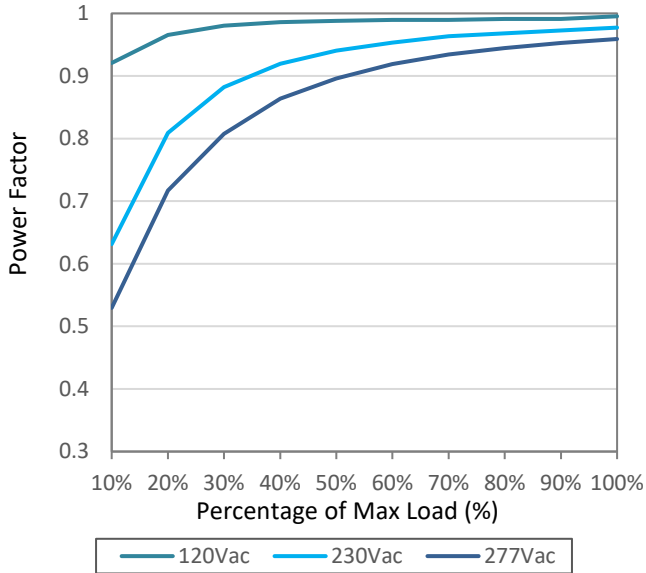

LNE-36V600BGA

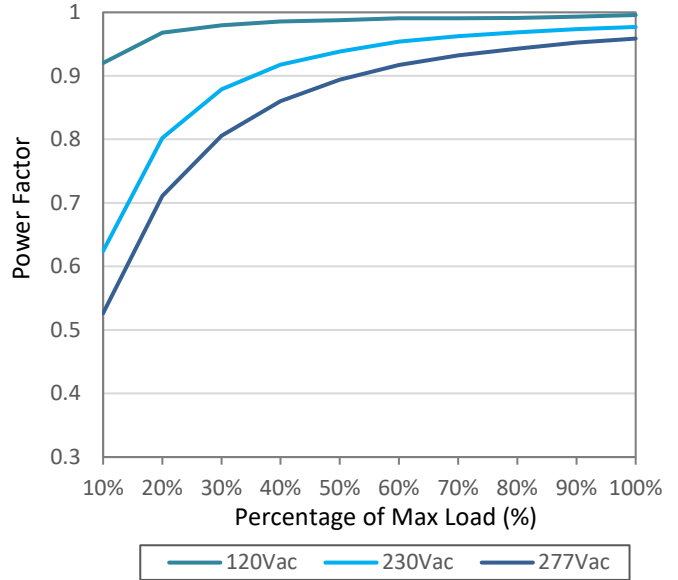

LNE-48V600WBGA

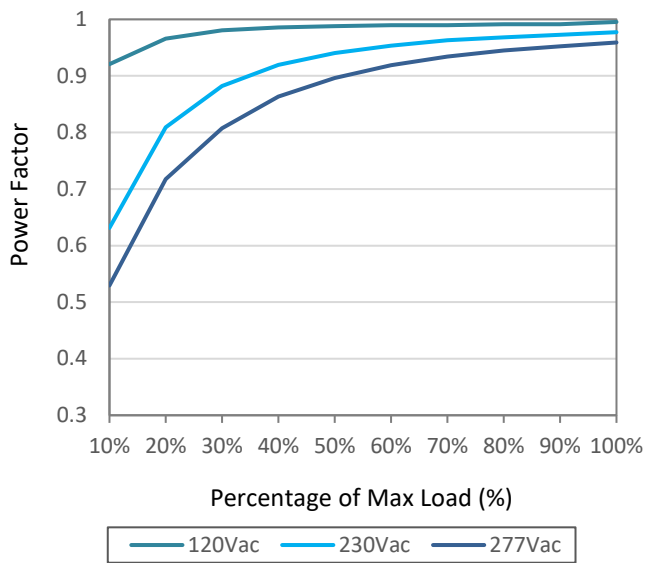

LNE-54V600BGA

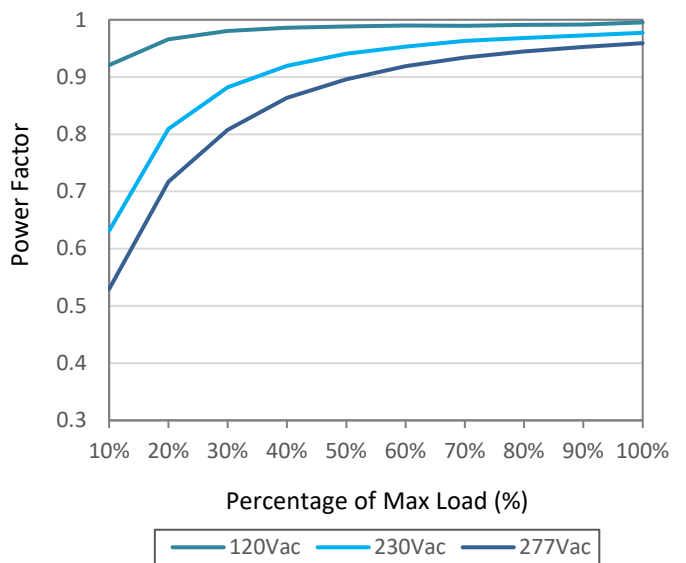

LED Driver

LNE-600W Series / LNE-□V600WBGA

Model Number	LNE-24V600W	LNE-36V600W	LNE-48V600W	LNE-54V600W
--------------	-------------	-------------	-------------	-------------

Mechanical

Casing	Aluminum			
Dimensions (L x W x D)	307.5 x 114.3 x 50.8 mm (12.11 x 4.5 x 2 inch)			
Unit Weight	3.15 kg (6.94 lb)			
Cooling System	Convection			
Wire	Input	SJOW	3x17AWG 105°C/ 3G 1.0mm ²	Line: Brown, Neutral: Blue PE: Green/Yellow
	Output	SJTW	14AWG 2C	Positive: Red, Negative: Black
	5V Standby & Remote Control	SJTW	18AWG 3C	PSON/OFF: Blue, GND: Black +5VSB: Brown
Noise (1 Meter from power supply)	Sound Pressure Level (SPL) < 25dBA			

Environment

Surrounding Air Temperature	Operating	-40°C to +70°C (Refer to “de-rating curve”)
	Storage	-40°C to +85°C
Power De-rating	> 50°C de-rate power by 2.5% / °C < 120Vac de-rate power by 1.5% / Vac	
Operating Humidity	5 to 95% RH (Non-Condensing)	
Operating Altitude	0 to 3,000 Meters	
Shock Test (Non-Operating)	IEC 60068-2-27, Half Sine Wave: 50G for a duration of 11ms, 3 shocks for each 3 directions	
Vibration (Non-Operating)	IEC 60068-2-6, Random: 5 Hz to 500 Hz (2.09G); 20 min per axis for all X, Y, Z direction	
Pollution Degree	2	
Location Ratings (Included in safety approvals)	Dry, Damp, Wet ratings	
Type H/L (Included in safety approvals)	UL Class I, Division 2, Hazardous Location (for IP67 version)	

Protections

Oversvoltage	27.6-33.6V, Latch Mode	41.4-50.4V, Latch Mode	55.2-67.2V, Latch Mode	62.1-75.6V, Latch Mode
Overload / Overcurrent	95-108% of rated load current, constant current limit			
Over Temperature	Latch Mode			
Short Circuit	Auto-Recovery when the fault is removed			
Degree of Protection	IP67			
Protection Against Shock	Class I with PE*5 connection			

*5 PE: Primary Earth

LED Driver

LNE-600W Series / LNE-□V600WBGA

Model Number	LNE-24V600W	LNE-36V600W	LNE-48V600W	LNE-54V600W
--------------	-------------	-------------	-------------	-------------

Reliability Data

MTBF	> 700,000 hrs. as per Telcordia SR-332. (I/P: 120Vac, O/P: 100% load, Ta: 25°C)
Expected Cap Life Time	7 years (I/P: 120Vac & 230Vac, O/P: 50% load @ Ta = 40°C)

Safety Standards / Directives

Electrical Safety	CB scheme ENEC	IEC 61347-1, IEC 61347-2-13 EN 61347-1, EN 61347-2-13, EN 62384
	UL/cUL recognized	UL 8750 and CAN/CSA C22.2 No.250.13 (Safety approval and dry, damp, wet ratings)
CE		In conformance with EMC Directive 2014/30/EU and Low Voltage Directive 2014/35/EU
Galvanic Isolation		Input to Output
	Input to Ground	3.3KVac
	Output to Ground	2KVac
Insulation	I/P-O/P, I/P-FG,	1.5KVac

EMC

EMC / Emissions		CISPR 15, EN 55015, Compliance to CISPR 32, EN 55032, FCC Title 47: Class B
Immunity to		Compliance to EN 61547 and EN55024
Electrostatic Discharge	IEC 61000-4-2	Level 4 Criteria A ¹⁾ Air Discharge: 15kV Contact Discharge: 8kV
Radiated Field	IEC 61000-4-3	Level 3 Criteria A ¹⁾ 80 MHz-1 GHz, 10V/M with 1 kHz tone / 80% modulation
Electrical Fast Transient / Burst	IEC 61000-4-4	Level 3 Criteria A ¹⁾ 2kV
Surge	IEC 61000-4-5	Common Mode ³⁾ : 6kV Differential Mode ⁴⁾ : 4kV
	EN 61547	Common Mode ³⁾ : Single pulse 10kV ; 12 Ohm 1.2/50us, 8/20us Differential Mode ⁴⁾ : Single pulse 10kV ; 12 Ohm, 1.2/50us, 8/20us
Conducted	IEC 61000-4-6	Level 3 Criteria A ¹⁾ 150 kHz-80 MHz, 10Vrms
Power Frequency Magnetic Fields	IEC 61000-4-8	Level 3 Criteria A ¹⁾ 10A/Meter
Voltage Dips	IEC 61000-4-11	100% dip, 0.5 cycle, Criteria A ¹⁾ 30% dip, 10 cycle, Criteria B ²⁾ @ 120Vac 30% dip, 10 cycle, Criteria A ¹⁾ @ 230Vac
Harmonic Current Emission		IEC/EN 61000-3-2, Class C
Voltage Fluctuation and Flicker		IEC/EN 61000-3-3

1) Criteria A: Normal performance within the specification limits

2) Criteria B: Temporary degradation or loss of function which is self-recoverable

3) Asymmetrical: Common mode (Line to earth)

4) Symmetrical: Differential mode (Line to line)

LED Driver

LNE-600W Series / LNE-□V600WBGA

Dimensions

L x W x D: 307.5 x 114.3 x 50.8 mm (12.11 x 4.5 x 2 inch)
LNE-24V600WBGA

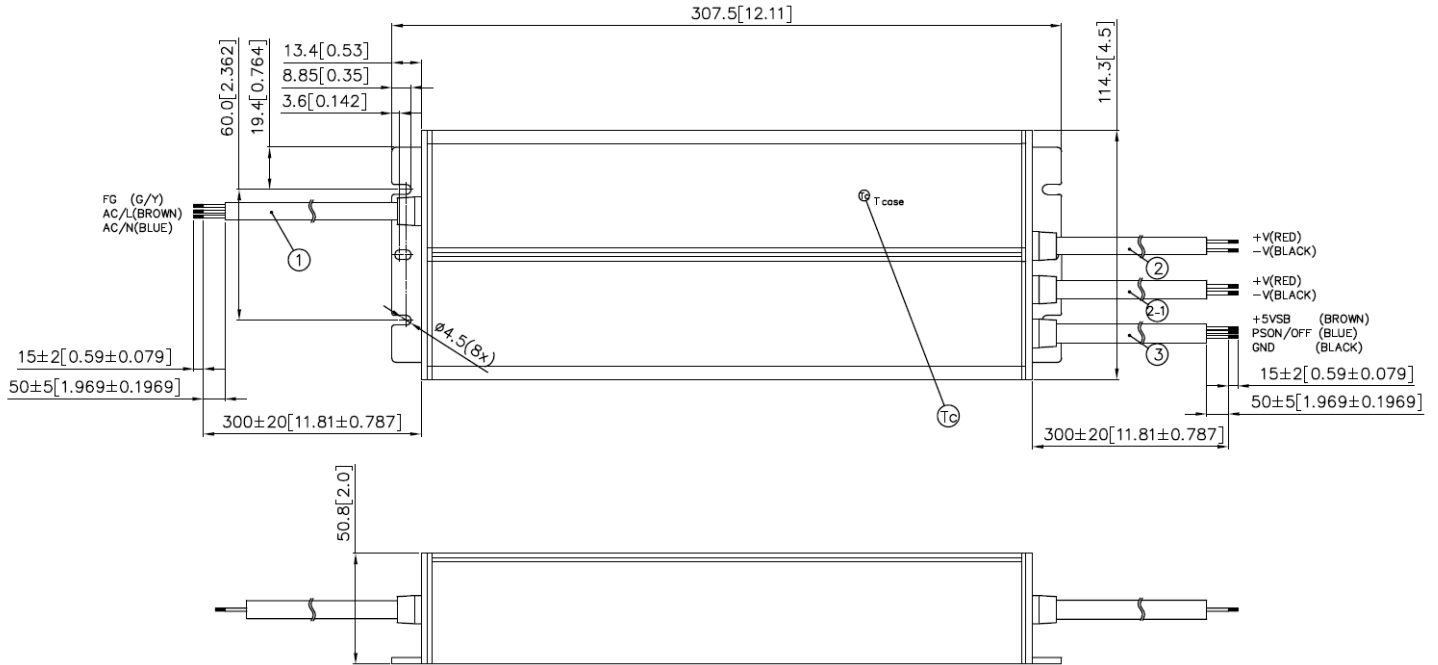

Item	Device Description
1	Input Cable
2	Output Cable
2-1	Output Cable
3	+5V Auxiliary Cable & Remote Control (PSON_OFF signal)
tc	T case (tc): Temperature hot spot location on case. The temperature at this location will not exceed 90°C when used in accordance to conditions in this data sheet.

LED Driver

LNE-600W Series / LNE-□V600WBGA

LNE-36V600WBGA, LNE-48V600WBGA, LNE-54V600WBGA

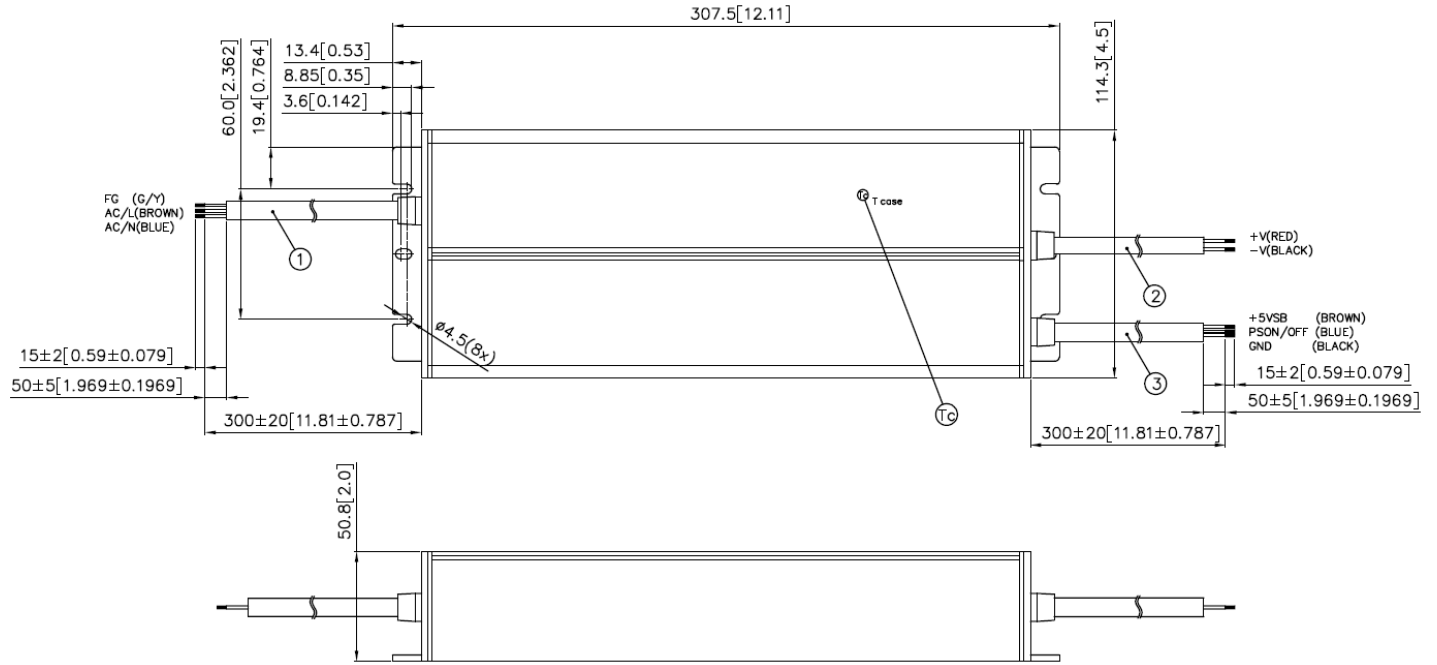

Item	Device Description
1	Input Cable
2	Output Cable
3	+5V Auxiliary Cable & Remote Control (PSON_OFF signal)
tc	T case (tc): Temperature hot spot location on case. The temperature at this location will not exceed 90°C when used in accordance to conditions in this data sheet.

LED Driver

LNE-600W Series / LNE-□V600WBGA

Engineering Data

Output Load De-rating VS Surrounding Air Temperature

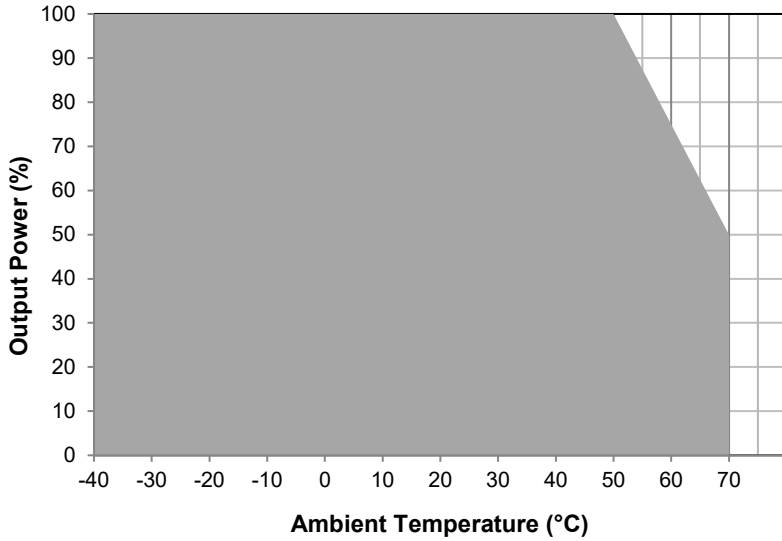

Fig. 1 De-rating for All Mounting Orientation
 > 50°C de-rate power by 2.5% / °C

Note

1. Power supply components may degrade, or be damaged, when the power supply is continuously used outside the shaded region, refer to the graph shown in Fig. 1.
2. If the output capacity is not reduced when the surrounding air temperature > 50°C, the device will run into Over Temperature Protection. When activated, the output voltage will go into bouncing mode and will recover when the surrounding air temperature is lowered or the load is reduced as far as necessary to keep the device in working condition.
3. Depending on the surrounding air temperature and output load delivered by the power supply, the device can be very hot!

Output Load De-rating VS Input Voltage

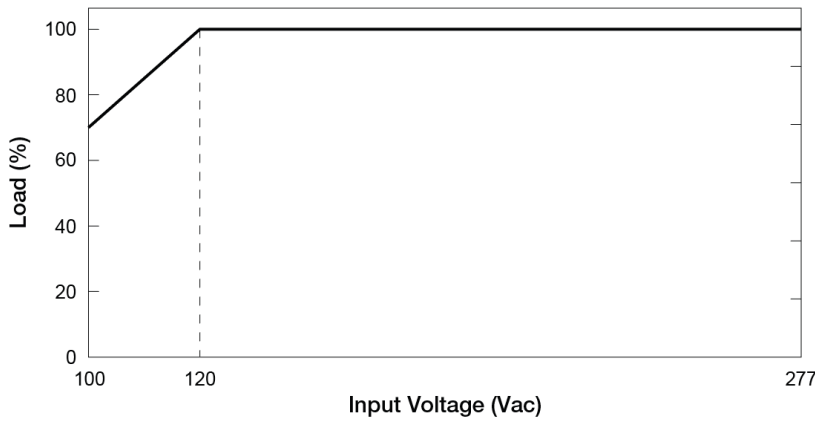

Fig. 2 De-rating for Low Input Voltage (All Models)
 < 120Vac de-rate power by 1.5% / Vac

- No output power de-rating for the input voltage from: 120Vac to 277Vac

LED Driver

LNE-600W Series / LNE-□V600WBGA

Output Load VS LED Driver Case Temperature

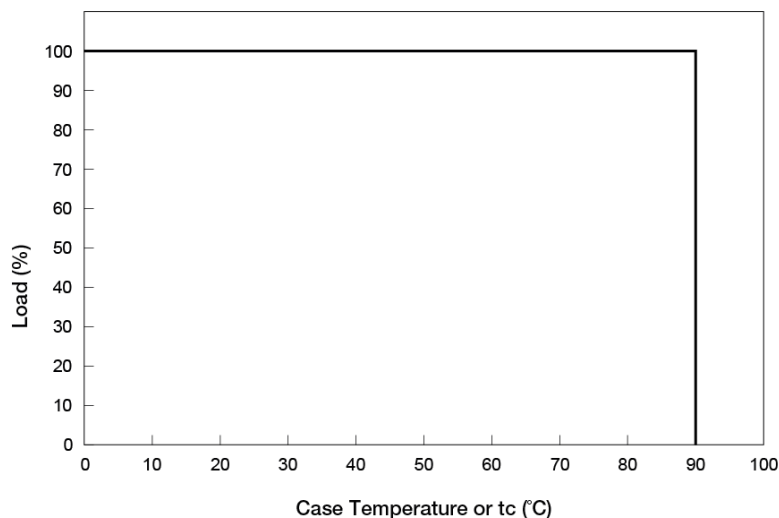

■ The LED Driver can support 100% rated load for case hot spot surface temperatures of less than 90°C.

Assembly & Installation

Mounting holes for LED driver assembly onto the mounting surface.

- Ⓐ, Ⓑ Mounting holes for the LED driver (device). There are 3 mounting holes at either end of the device (locations Ⓐ and Ⓑ in Fig. 3). The device shall be mounted using a minimum of 2 out of the 3 mounting holes on both sides. Mounting shall be done using M4 screws with minimum length of 5mm. If customer's end system or panel where the device is mounted does not have screw threads, please use suitable metal screw and nut to secure the device.
- Ⓒ Surface Ⓒ belongs to customer's end product or panel where the device is mounted. The device should be mounted on a sturdy heat conducting surface with minimum of 4 mounting holes, as detailed above.



Fig. 3 Mounting Hole Locations

Safety Instructions

- ALWAYS switch mains of input power OFF before connecting and disconnecting the input voltage to the device. If mains are not turned OFF, there is risk of explosion / severe damage.
- To guarantee sufficient convection cooling, keep a distance of 50mm above and lateral distance to nearby objects.
- The device is not recommended to be placed on low thermal conductive surfaces. For example, plastics.
- DO NOT insert any objects into the device.
- Note that the enclosure of the device can become very hot depending on the surrounding air temperature and output load connected to the device. Risk of burns!
- If the device is continuously operating outside the shaded region shown in Fig. 1. The device may be damaged or degraded.
- When the PE (Green/Yellow) wire of the device is not connected, the device must be installed on a metal plate that has a PE connection.
- The current rating for the all wires, connected to the input and output wires of the device, must be rated higher than or equal to the input and output current of the power supply. The suggested length of wire connected to output wire should not be over 2 meter. Please refer to the product specifications.
- Please ensure the correct tools are used for all adjustments and installations of the device. If in doubt, please consult your local Delta support or contact us via info@DeltaPSU.com.

LED Driver

LNE-600W Series / LNE-□V600WBGA

Functions

Start-up Time

The time required for the output voltage to reach 90% of its final steady state set value, after the input voltage is applied.

Rise Time

The time required for the output voltage to change from 10% to 90% of its final steady state set value.

Hold-up Time

Time between the collapse of the AC input voltage, and the output falling to 95% of its steady state set value.

- Graph illustrating the Start-up Time, Rise Time, and Hold-up Time

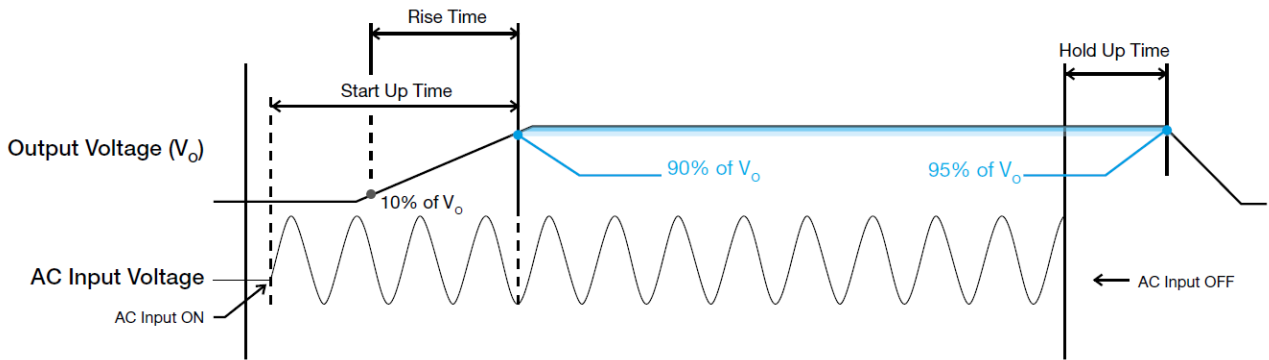

Inrush Current

Inrush current is the peak, instantaneous, input current measured and, occurs when the input voltage is first applied. For AC input voltages, the maximum peak value of inrush current will occur during the first half cycle of the applied AC voltage. This peak value decreases exponentially during subsequent cycles of AC voltage.

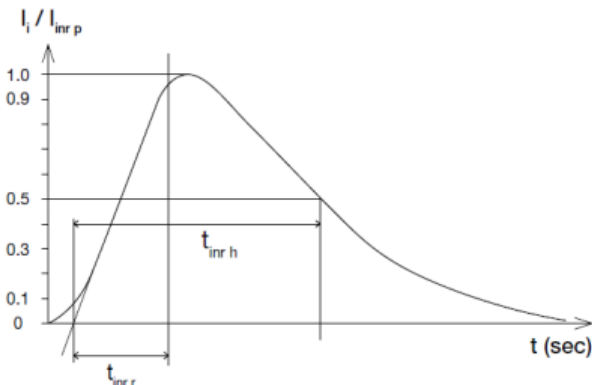

Dynamic Response (For CV Operation Only)

The power supply output voltage will remain within $\pm 5\%$ of its steady state value, when subjected to a dynamic load from 0 to 90% of its rated current.

- 90% Duty / 1 KHz

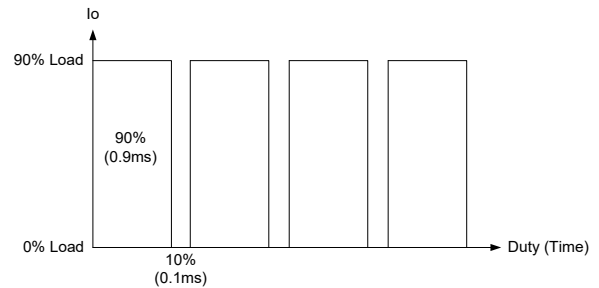

- 90% Duty / 120 Hz

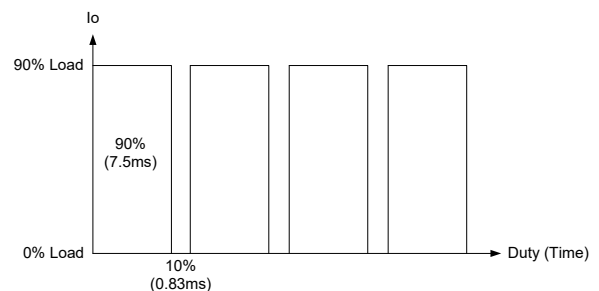

LED Driver

LNE-600W Series / LNE-□V600WBGA

Operating Methods of LED Modules-CV and CC Operation

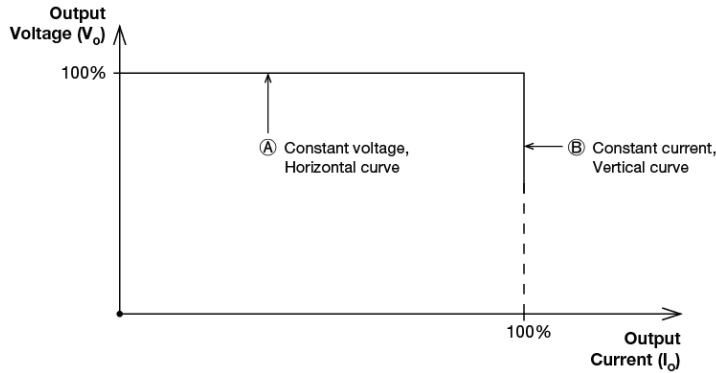

A typical LED power supply is able to either work in "constant voltage mode (CV) or constant current mode (CC)" to drive the LEDs. DELTA's LNE drivers integrate CV+CC characteristics; so operation in CV mode (with external LED driver), in region (A) or CC mode (direct drive, at area (B)).

In the constant current region, the highest voltage at the output of the driver depends on the configuration of the end systems. Should there be any compatibility issues or other questions with these adjustment methods, please contact with Delta.

External Input Protection Device

The unit is protected at the L pin, with an internal fuse that cannot be replaced. The power supply has been tested and approved on 20A branch circuits without additional protection device. An external protection device is only required if the supplying branch has an ampacity greater than above. Thus, if an external protective device is necessary, a 20 Ampere C-characteristic circuit breaker can be utilized.

Overload & Overcurrent Protections (Auto-Recovery)

The power supply's Overload (OLP) and Overcurrent (OCP) Protections will be activated when output current is between 95% and 108% of I_o (Max load). Upon such an occurrence, the V_o (output voltage) will start to droop. Once the power supply has reached its maximum power limit, the protection will be activated; and, the power supply will operate in "CC mode". The power supply will recover once the fault condition once the cause of OLP or OCP is removed, and I_o (output current) is back within the specified range.

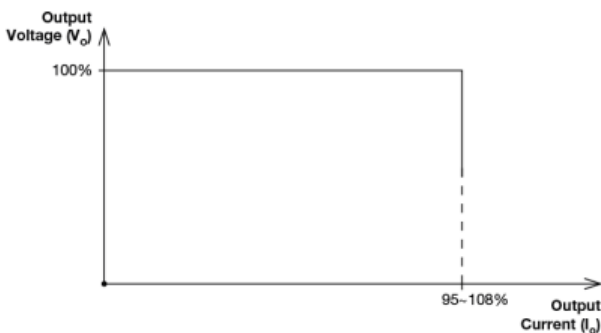

Short Circuit Protection (Auto-Recovery)

The power supply's output OLP/OCP function also provides protection against short circuits. When a short circuit is applied, the power supply will operate in "CC mode", as shown in the illustration in the OLP/OCP section on this page. The power supply will return to normal operation after the short circuit is removed.

Overvoltage Protection (Latch Mode)

The power supply's overvoltage circuit will be activated when its internal feedback circuit fails. The output voltage shall not exceed its specifications as described in "Protections" section. Power supply will latch, and require removal/re-application of input AC voltage in order to restart.

The power supply should be latch.

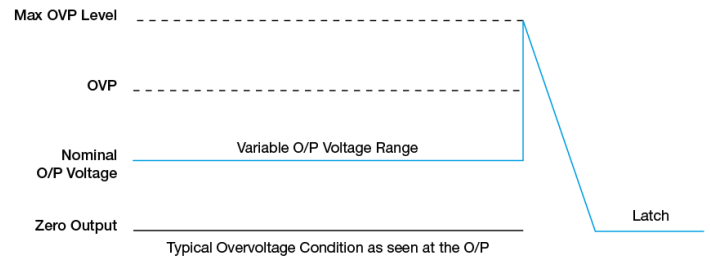

Over Temperature Protection (Latch)

As described in load de-rating section, the power supply also has Over Temperature Protection (OTP). In the event of a higher operating temperature at 100% load, the power supply will run into OTP when the operating temperature is beyond what is recommended in the de-rating graph. When activated, power supply will latch, and require removal/re-application of input AC voltage in order to restart.