



Parameter	Rating	Units
LED Operating Range	2-10	mA
K3, Transfer Gain	0.733-1.072	-
Isolation, Input to Output	3750	V <sub>rms</sub>

### Features

- 0.01% Servo Linearity
- THD -87dB Typical
- Wide Bandwidth (>200kHz)
- Couples Analog and Digital Signals
- High Gain Stability
- Low Input/Output Capacitance
- Low Power Consumption
- 8-Pin Flatpack or DIP Package (PCMCIA Compatible)
- Machine Insertable, Wave Solderable
- Surface Mount and Tape & Reel Versions Available
- VDE Compatible

### Applications

- Modem Transformer Replacement With No Insertion Loss
- Digital Telephone Isolation
- Power Supply Feedback Voltage/Current
- Medical Sensor Isolation
- Audio Signal Interfacing
- Isolation of Process Control Transducers

### Description

The LOC111 Single Linear Optocoupler features an infrared LED optically coupled with two photodiodes. One feedback (input) photodiode is used to generate a control signal that provides a servomechanism to the LED drive current, thus compensating for the LED's nonlinear time and temperature characteristics. The other (output) photodiode provides an output signal that is linear with respect to the servo LED current. The product features wide bandwidth, high input to output isolation, and excellent servo linearity.

### Approvals

- UL Recognized Component: File E76270
- CSA Certified Component: Certificate 1175739
- Certified to:
  - IEC60950-1: 2005
  - EN60950-1: 2006
  - TUV Certificate B 09 07 49410 006

### Ordering Information

Part Number	Description
LOC111	8-Pin DIP (50/Tube)
LOC111P	8-Pin Flatpack (50/Tube)
LOC111PTR	8-Pin Flatpack (1000/Reel)
LOC111S	8-Pin Surface Mount (50/tube)
LOC111STR	8-Pin Surface Mount (1000/Reel)

#### K3 Sorted Bins

Bin D = 0.733 - 0.805
Bin E = 0.806 - 0.886
Bin F = 0.887 - 0.974
Bin G = 0.975 - 1.072

- The LOC111 will be shipped using bins available at date of order. Any bin (D - G) can be shipped. Each tube or reel will contain one K3-sorted bin. Each device will be marked with the designated bin.

### Pin Configuration

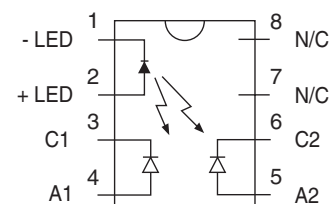

### Absolute Maximum Ratings @ 25°C

Parameter	Ratings	Units
Reverse LED Voltage	5	V
Input Control Current	100	mA
Peak (10ms)	1	A
Input Power Dissipation <sup>1</sup>	150	mW
Total Package Dissipation <sup>2</sup>	500	mW
Isolation Voltage, Input to Output	3750	V <sub>rms</sub>
Operational Temperature	-40 to +85	°C
Storage Temperature	-40 to +125	°C

<sup>1</sup> Derate linearly 1.33 mW / °C

<sup>2</sup> Derate linearly 6.67 mW / °C

Absolute Maximum Ratings are stress ratings. Stresses in excess of these ratings can cause permanent damage to the device. Functional operation of the device at conditions beyond those indicated in the operational sections of this data sheet is not implied.

### Electrical Characteristics @ 25°C

Parameter	Conditions	Symbol	Min	Typ	Max	Units
<b>Input Characteristics</b>						
LED Voltage Drop	$I_F = 2 - 10\text{mA}$	$V_F$	0.9	1.2	1.4	V
Reverse LED Current	$V_R = 5\text{V}$	$I_R$	-	-	10	μA
<b>Coupler/Detector Characteristics</b>						
Dark Current	$I_F=0\text{mA}, V_{C1-A1}=V_{C2-A2}=15\text{V}$	$I_D$	-	1	25	nA
K1, Servo Gain ( $I_{C1}/I_F$ )	$I_F=2 - 10\text{mA}, V_{C1-A1}=V_{C2-A2}=15\text{V}$	K1	0.008	-	0.030	-
K2, Forward Gain ( $I_{C2}/I_F$ )		K2	0.006	-	0.030	-
K3, Transfer Gain ( $K2/K1=I_{C2}/I_{C1}$ )		K3	0.733	1	1.072	-
ΔK3, Transfer Gain Linearity (non-servoed)	$I_F=2 - 10\text{mA}$	ΔK3	-	-	1	%
K3 Temperature Coefficient	$I_F=2 - 10\text{mA}, V_{C1-A1}=V_{C2-A2}=5\text{V}$	ΔK3/ΔT	-	0.005	-	% / °C
Common-Mode Rejection Ratio	$V=20\text{V}_{P-P}, R_L=2\text{k}\Omega, f=100\text{Hz}$	CMRR	-	130	-	dB
Total Harmonic Distortion	$f_0=350\text{Hz}, 0\text{dBm}$	THD	-96	-87	-80	dB
Frequency Response <sup>1</sup>	Photoconductive Configuration	$f_{-3dB}$	-	200	-	kHz
	Photovoltaic Configuration			40		
Input/Output Capacitance	-	$C_{I/O}$	-	3	-	pF

<sup>1</sup> Refer to Application Note, AN-107, for LOC111 Configurations.

**PERFORMANCE DATA @25°C (Unless Otherwise Noted)\***

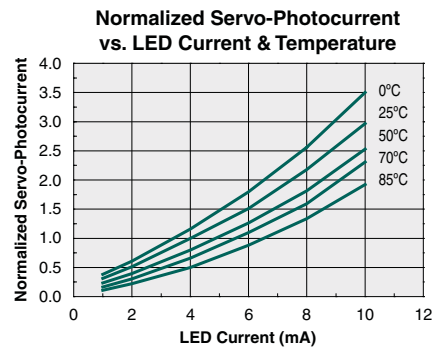
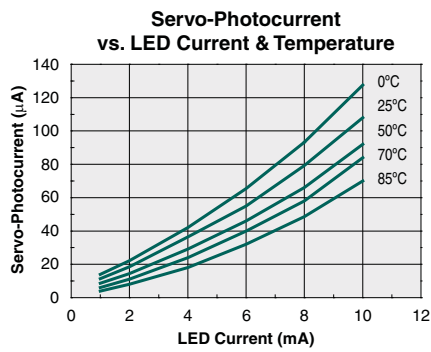
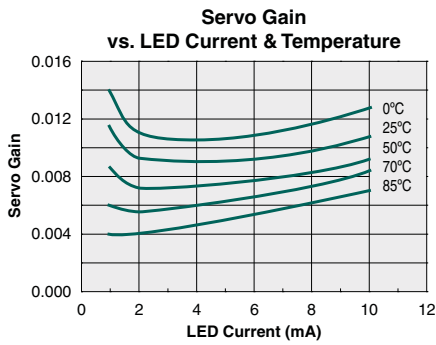
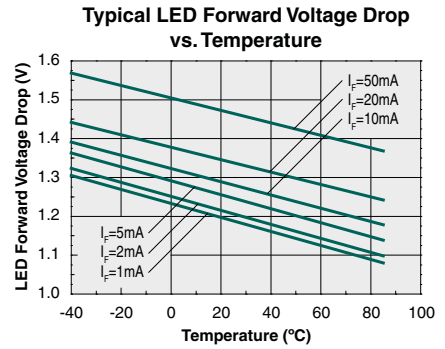
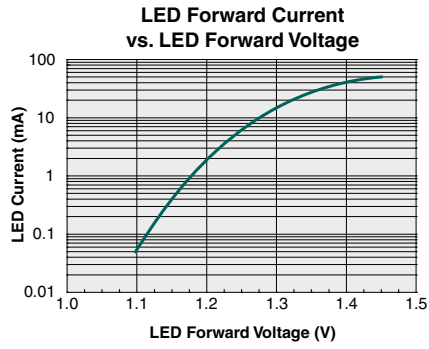
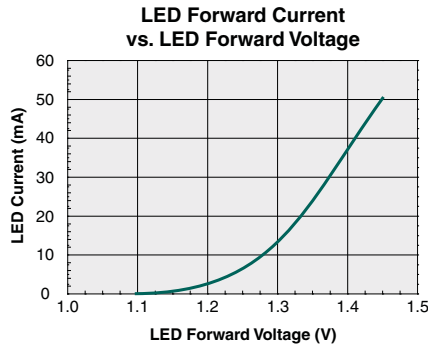

\*The Performance data shown in the graphs above is typical of device performance. For guaranteed parameters not indicated in the written specifications, please contact our application department.

## Manufacturing Information

### Moisture Sensitivity



All plastic encapsulated semiconductor packages are susceptible to moisture ingress. IXYS Integrated Circuits Division classified all of its plastic encapsulated devices for moisture sensitivity according to the latest version of the joint industry standard, **IPC/JEDEC J-STD-020**, in force at the time of product evaluation. We test all of our products to the maximum conditions set forth in the standard, and guarantee proper operation of our devices when handled according to the limitations and information in that standard as well as to any limitations set forth in the information or standards referenced below.

Failure to adhere to the warnings or limitations as established by the listed specifications could result in reduced product performance, reduction of operable life, and/or reduction of overall reliability.

This product carries a **Moisture Sensitivity Level (MSL) rating** as shown below, and should be handled according to the requirements of the latest version of the joint industry standard **IPC/JEDEC J-STD-033**.

Device	Moisture Sensitivity Level (MSL) Rating
LOC111 / LOC111P / LOC111S	MSL 1

### ESD Sensitivity



This product is **ESD Sensitive**, and should be handled according to the industry standard **JESD-625**.

### Reflow Profile

This product has a maximum body temperature and time rating as shown below. All other guidelines of **J-STD-020** must be observed.

Device	Maximum Temperature x Time
LOC111 / LOC111S	250°C for 30 seconds
LOC111P	260°C for 30 seconds

### Board Wash

IXYS Integrated Circuits Division recommends the use of no-clean flux formulations. However, board washing to remove flux residue is acceptable. Since IXYS Integrated Circuits Division employs the use of silicone coating as an optical waveguide in many of its optically isolated products, the use of a short drying bake could be necessary if a wash is used after solder reflow processes. Chlorine- or Fluorine-based solvents or fluxes should not be used. Cleaning methods that employ ultrasonic energy should not be used.



**Mechanical Dimensions**

**LOC111**

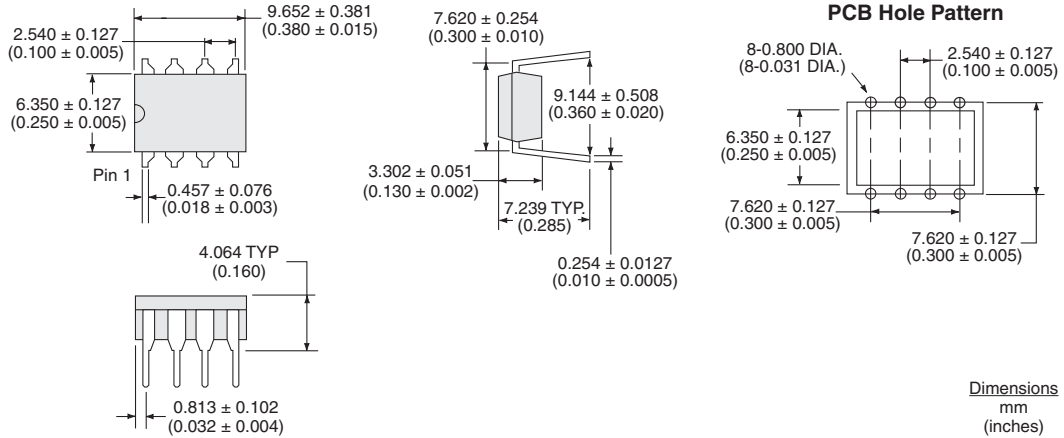

**LOC111P**

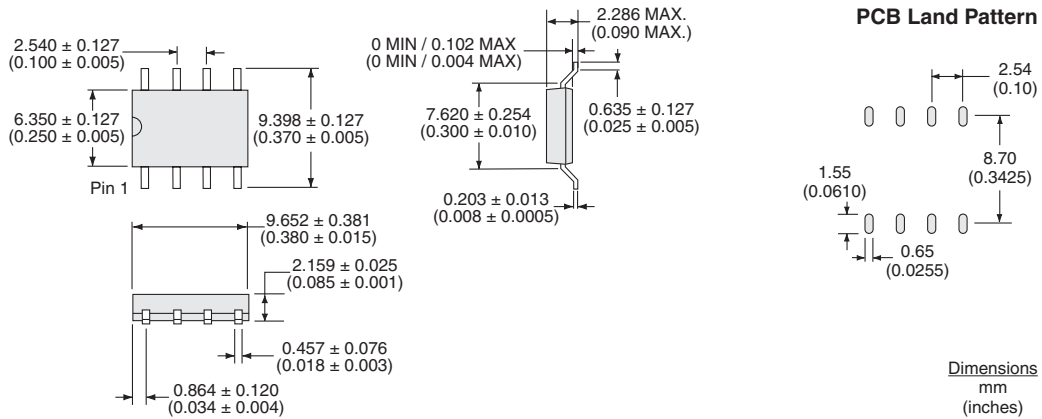

**LOC111S**

