

## LPC-H1114 development board

## Users Manual



Pb-free, Green

All boards produced by Olimex are ROHS compliant

Revision B, June 2012

Copyright(c) 2011, OLIMEX Ltd, All rights reserved

## INTRODUCTION

**LPC-P1114** is development board with LPC1114FBD48 ARM Cortex-M0 based microcontroller for embedded applications from NXP. LPC-P1114 featuring a high level of integration and low power consumption. This microcontroller supports various interfaces such as one Fast-mode Plus I2C-bus interface, one RS-485/EIA-485 UART, two SSP interfaces, four general purpose timers, a 10-bit ADC. On the board are available Debug Interface and extension headers for all microcontroller ports.

## BOARD FEATURES

- MCU: **LPC1114FBD48/301/302** Cortex-M0, up to 50 Mhz, 32 kB Flash, 8kB SRAM, UART RS-485, two SSP, I<sup>2</sup>C/Fast+, ADC
- Debug interface – SWD (Serial Wire Debug)
- Extension connectors
- FR-4, 1.5 mm, soldermask, component print
- Dimensions:38.00x38.00mm (1.50 x 1.50")

## ELECTROSTATIC WARNING

The **LPC-H1114** board is shipped in protective anti-static packaging. The board must not be subject to high electrostatic potentials. General practice for working with static sensitive devices should be applied when working with this board.

## BOARD USE REQUIREMENTS

**Cables:** The cable you will need depends on the programmer/debugger you use. If you use [ARM-JTAG-EW](#), you will need USB A-B cable.

**Hardware:** Programmer/Debugger [ARM-JTAG-EW](#), which works with IAR for ARM up to version 6.20 or other compatible programming/debugging tool.

[ARM-USB-OCD](#), [ARM-USB-OCD-H](#), [ARM-USB-TINY](#), [ARM-USB-TINY-H](#) - JTAGs + [ARM-JTAG-SWD](#) adapter can be used with Rowley Crossworks.

## PROCESSOR FEATURES

**LPC-P1114** board use ARM Cortex™-M0 microcontroller **LPC1114FBD48/301/302** from NXP Semiconductors with these features:

- ARM Cortex-M0 processor, running at frequencies of up to 50 MHz.
- ARM Cortex-M0 built-in Nested Vectored Interrupt Controller (NVIC).
- 32 kB on-chip flash programming memory.
- 8 kB SRAM.

- In-System Programming (ISP) and In-Application Programming (IAP) via on-chip bootloader software.
- Serial interfaces:
  - UART with fractional baud rate generation, internal FIFO, and RS-485 support.
  - Two SSP controllers with FIFO and multi-protocol capabilities
  - I<sup>2</sup>C-bus interface supporting full I<sup>2</sup>C-bus specification and Fast-mode Plus with a data rate of 1 Mbit/s with multiple address recognition and monitor mode.
- Other peripherals:
  - 42 General Purpose I/O (GPIO) pins with configurable pull-up/pull-down resistors. In addition, a configurable open-drain mode is supported on the LPC1114FBD48/302
  - Four general purpose timers/counters with a total of four capture inputs and 13 match outputs.
  - Programmable WatchDog Timer (WDT).
  - Programmable windowed WDT on LPC1114FBD48/302 only.
  - System tick timer.
- Serial Wire Debug.
- High-current output driver (20 mA) on one pin.
- High-current sink drivers (20 mA) on two I<sup>2</sup>C-bus pins in Fast-mode Plus.
- Integrated PMU (Power Management Unit) to minimize power consumption during Sleep, Deep-sleep, and Deep power-down modes.
- Power profiles residing in boot ROM allowing to optimize performance and minimize power consumption for any given application through one simple function call. (on LPC1114FBD48/302 only.)
- Three reduced power modes: Sleep, Deep-sleep, and Deep power-down.
- Single 3.3 V power supply (2.0 V to 3.6 V).
- 10-bit ADC with input multiplexing among 8 pins.
- GPIO pins can be used as edge and level sensitive interrupt sources.
- Clock output function with divider that can reflect the system oscillator clock, IRC clock, CPU clock, and the Watchdog clock
- Processor wake-up from Deep-sleep mode via a dedicated start logic using up to 13 of the functional pins.
- Brownout detect with four separate thresholds for interrupt and one threshold for forced reset.
- Power-On Reset (POR).

-Crystal oscillator with an operating range of 1 MHz to 25 MHz.

-12 MHz internal RC oscillator trimmed to 1 % accuracy that can optionally be used as a system clock.

-PLL allows CPU operation up to the maximum CPU rate without the need for a high-frequency crystal. May be run from the main oscillator, the internal RC oscillator, or the watchdog oscillator.

## **BLOCK DIAGRAM**

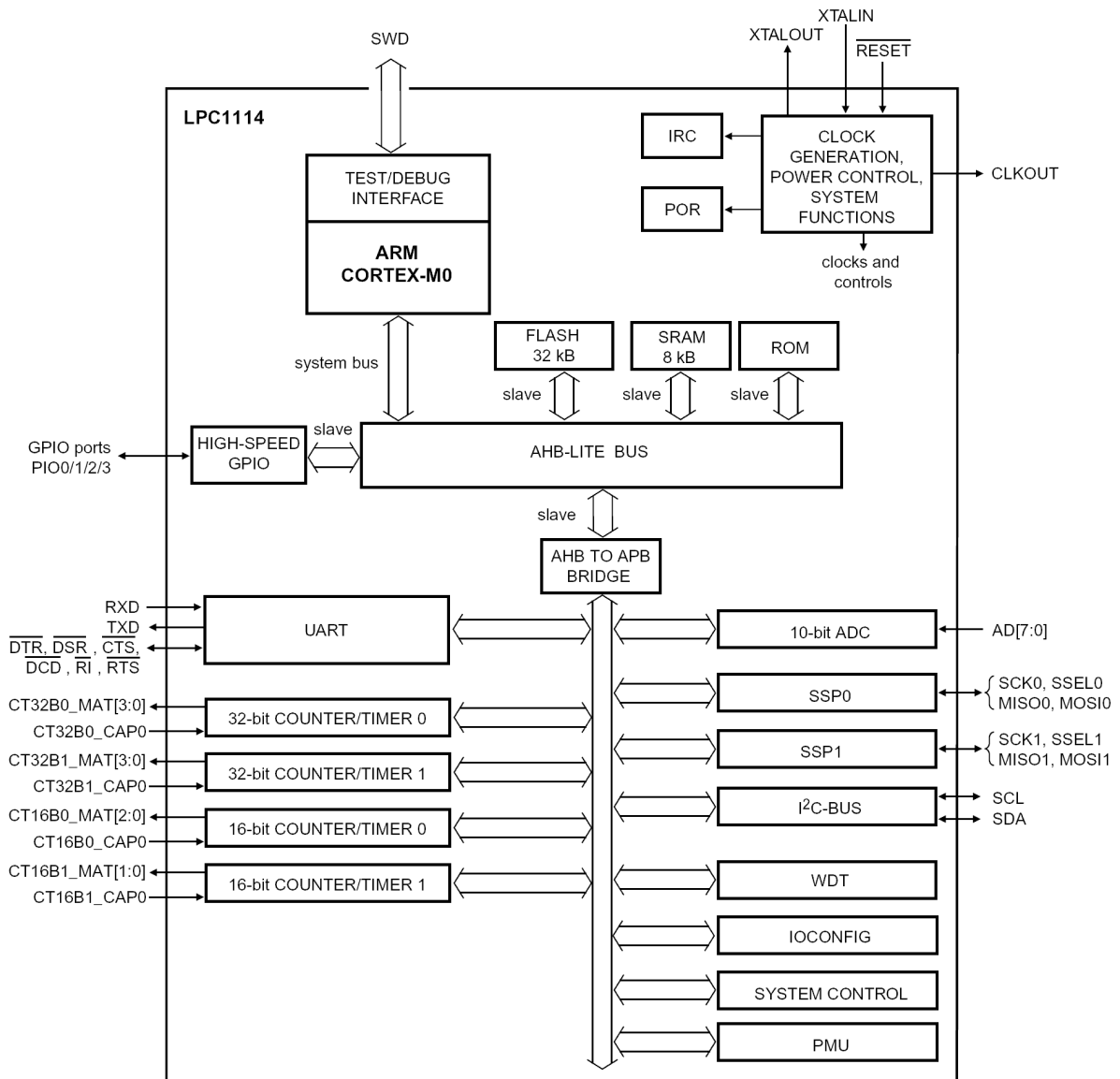

# MEMORY MAP

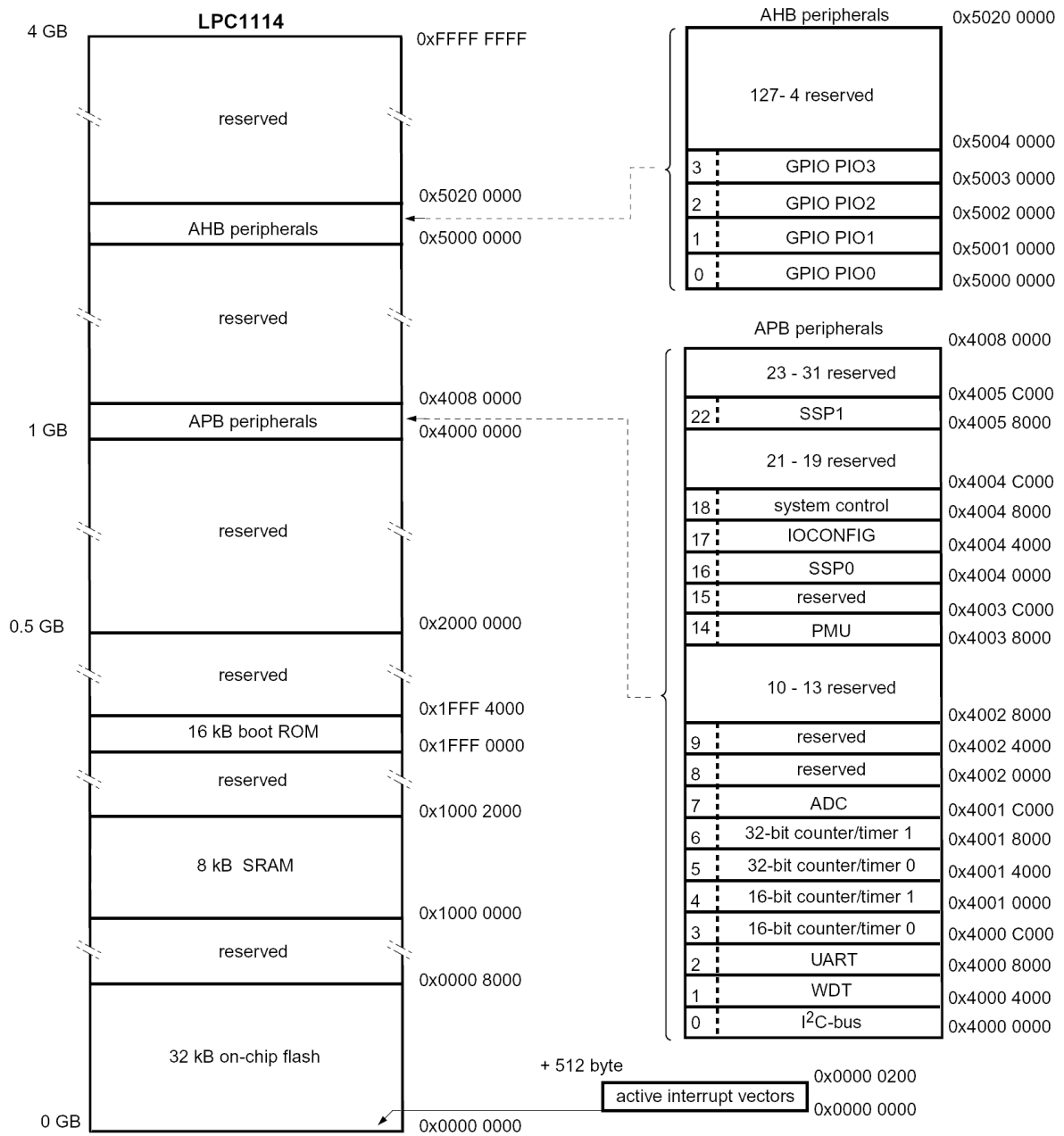

# SCHEMATIC

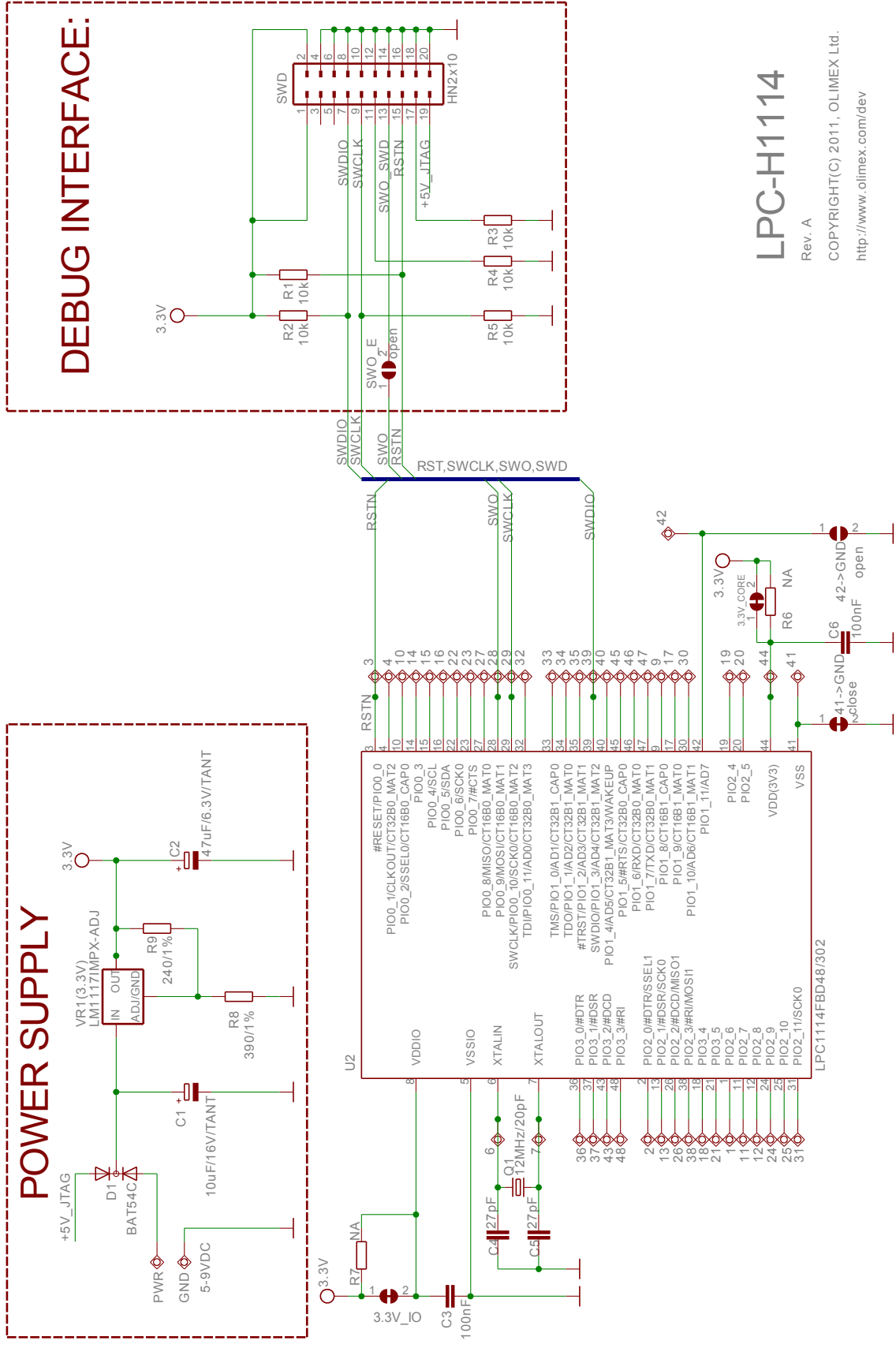

LPC-H1114

Rev. A  
COPYRIGHT(C) 2011, OLIMEX Ltd.  
<http://www.olimex.com/dev>

# BOARD LAYOUT

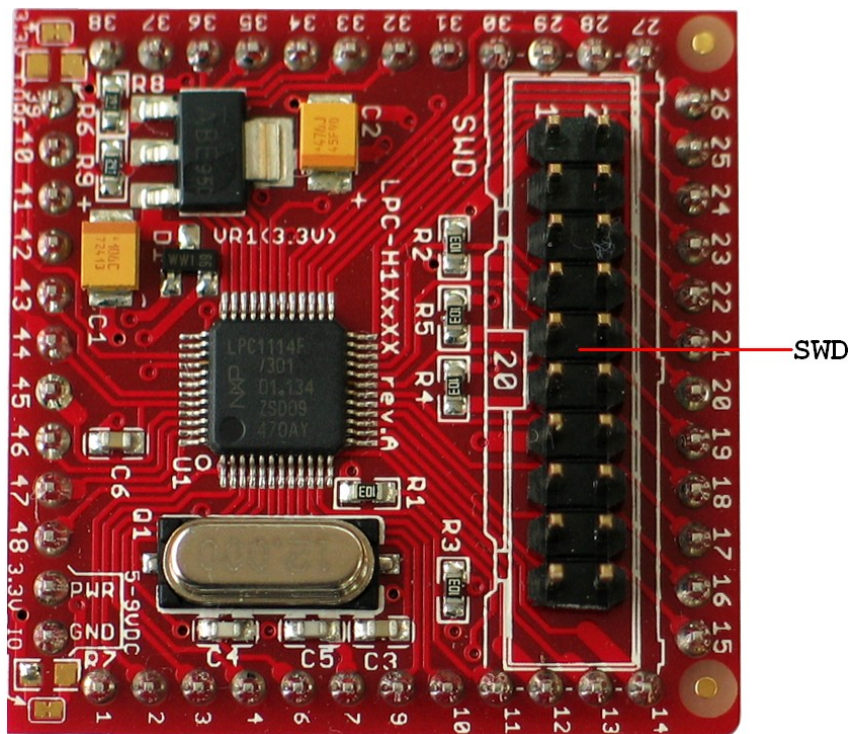

CON2

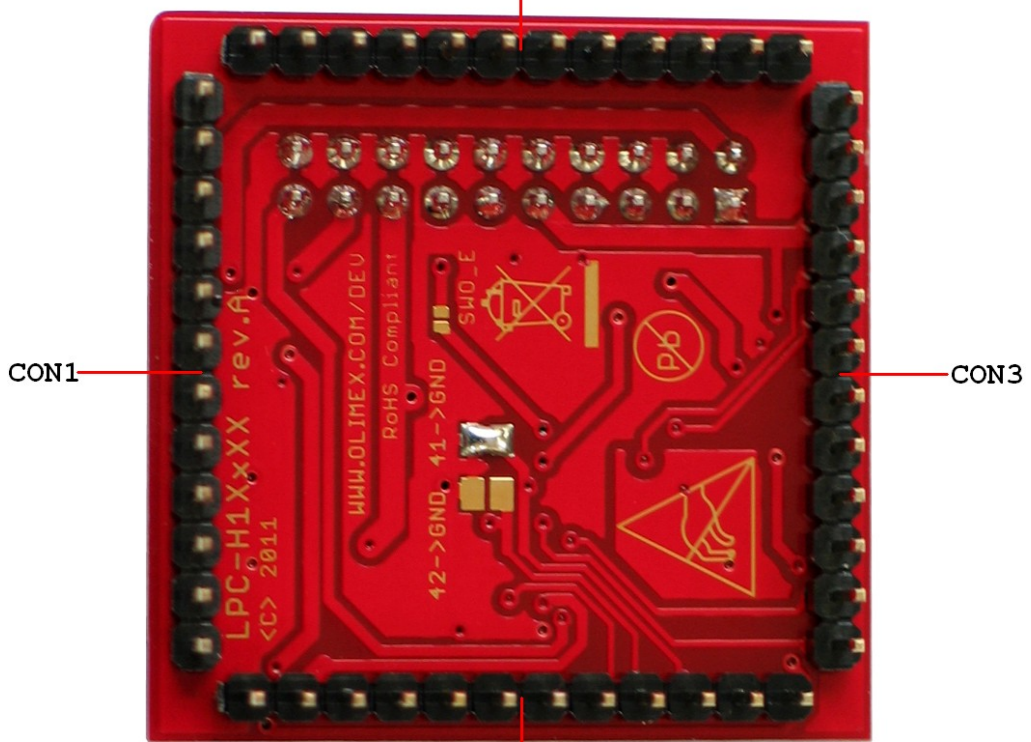

CON1

CON3

CON4

## POWER SUPPLY CIRCUIT

LPC-H1114 is power supplied with +5V via JTAG and (5÷9)VDC via Extension connector CON4 pins PWR and GND.

The board power consumption is about 20 mA.

## RESET CIRCUIT

LPC-P1114 reset circuit includes LPC1114 pin 3 (#RESET/PIO0\_0), R1 (10k) and SWD connector pin 15.

## CLOCK CIRCUIT

Quartz crystal 12 MHz is connected to LPC1114 pin 6 (XTALIN) and pin 7 (XTALOUT).

## JUMPER DESCRIPTION

### 3.3V\_CORE



This jumper, when closed, enables microcontroller 3.3V power supply.  
Default state is closed.

### 3.3V\_IO



This jumper, when closed, supplies 3.3 V voltage to LPC1114 pin 8 (VDDIO).  
Default state is closed.

### SWO\_E



This jumper, when closed, connects SWD connector pin 13 (SWO\_SWD) to LPC1114 pin 28 (PIO0\_9).  
Default state is opened.

### 41->GND



This jumper, when closed, connects LPC1114 pin 41 (VSS) to GND.  
Default state is closed.

### 42->GND



This jumper, when closed, connects LPC1114 pin 42 (PIO1\_11) to GND.  
Default state is opened.



**EXTERNAL CONNECTORS DESCRIPTION**

**SWD**

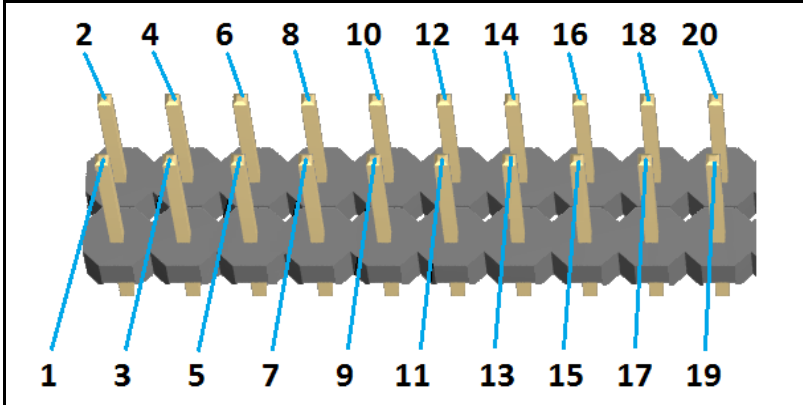

Pin #	Signal Name	Pin #	Signal Name
1	VCC (3.3V)	2	VCC (3.3V)
3	Not Connected	4	GND
5	Not Connected	6	GND
7	SWDIO	8	GND
9	SWCLK	10	GND
11	pull-down	12	GND
13	SWO_SWD	14	GND
15	RSTN	16	GND
17	pull-down	18	GND
19	+5V_JTAG	20	GND

## CON1

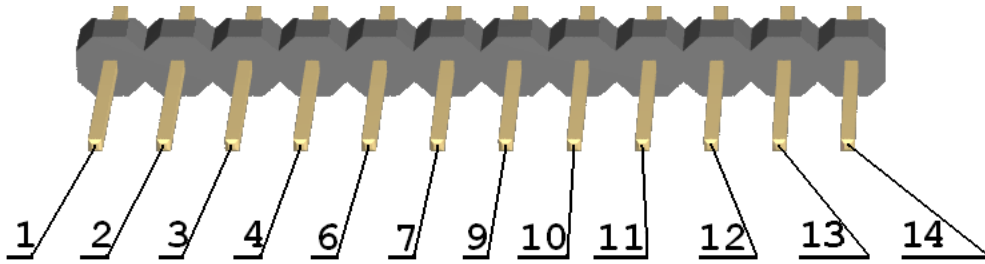

Pin #	Signal Name	Pin #	Signal Name
1	PIO2_6	2	PIO2_0
3	RSTN	4	PIO0_1
6	XTALIN	7	XTALOUT
9	PIO1_8	10	PIO0_2
11	PIO2_7	12	PIO2_8
13	PIO2_1	14	PIO0_3

## CON2

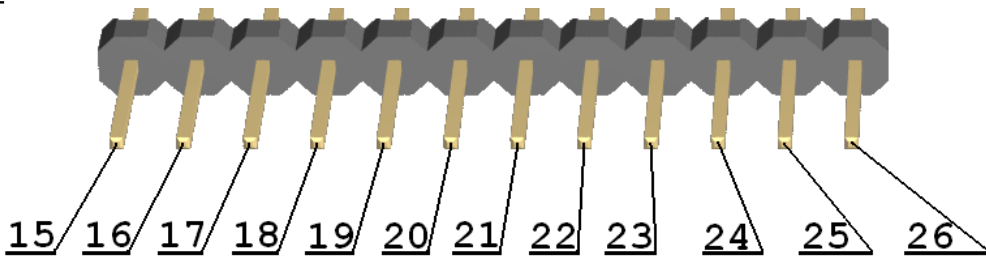

Pin #	Signal Name	Pin #	Signal Name
15	PIO0_4	16	PIO0_5
17	PIO1_9	18	PIO3_4
19	PIO2_4	20	PIO2_5
21	PIO3_5	22	PIO0_6
23	PIO0_7	24	PIO2_9
25	PIO2_10	26	PIO2_2

### CON3

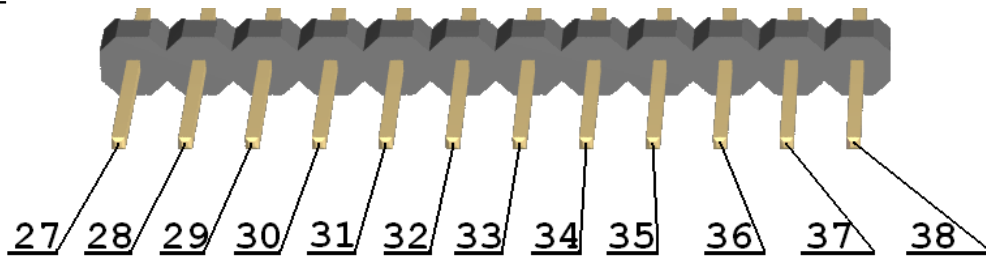

Pin #	Signal Name	Pin #	Signal Name
27	PIO0_8	28	SWO
29	SWCLK	30	PIO1_10
31	PIO2_11	32	PIO0_11
33	PIO1_0	34	PIO1_1
35	PIO1_2	36	PIO3_0
37	PIO3_1	38	PIO2_3

### CON4

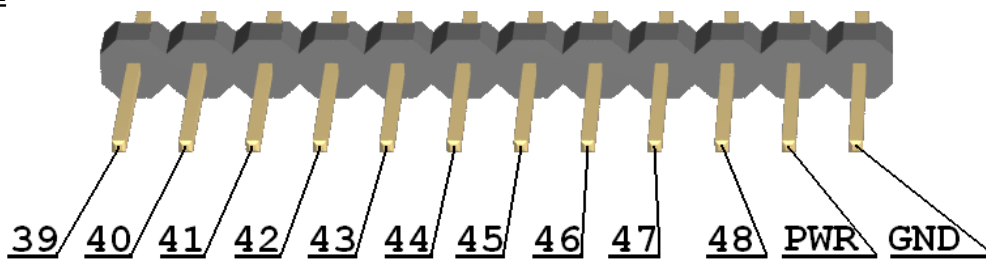

Pin #	Signal Name	Pin #	Signal Name
39	SWDIO	40	PIO1_4
41	VSS (GND)	42	PIO1_11
43	PIO3_2	44	VDD(3V3)
45	PIO1_5	46	PIO1_6
47	PIO1_7	48	PIO3_3
PWR	PWR	GND	GND

# MECHANICAL DIMENSIONS

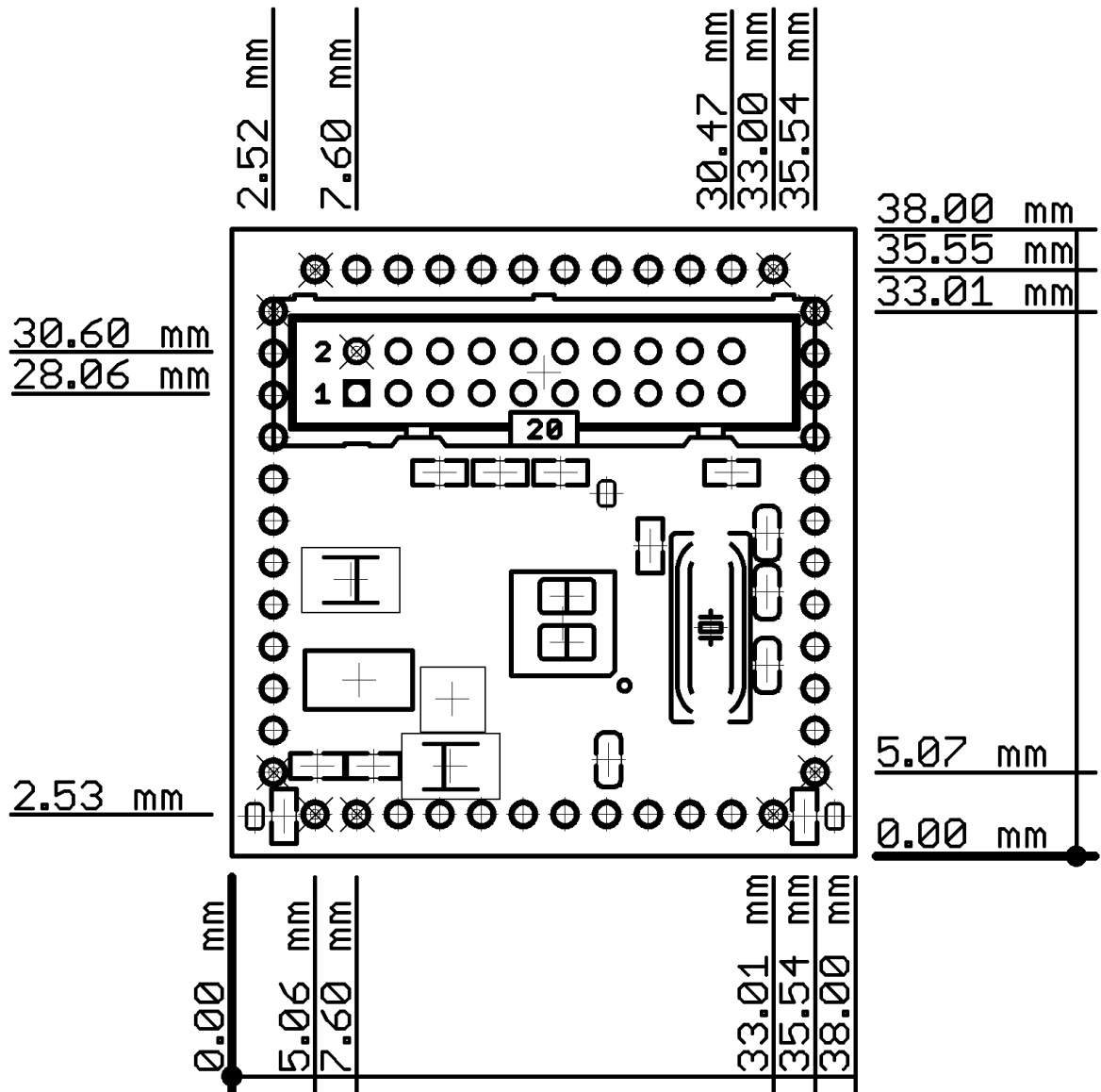

## AVAILABLE DEMO SOFTWARE

- Coming soon at our [website](#).

## **ORDER CODE**

**LPC-H1114** - assembled and tested board

### **How to order?**

You can order to us directly or by any of our distributors.  
Check our web [www.olimex.com/dev](http://www.olimex.com/dev) for more info.

## **Revision history**

Board's Revision	Rev. A, July 2011
Manual's Revision	Rev. Initial, September 2011
	Rev. B, June 2012 – changed wrong pin numbering of the picture on page 9