

LPC-2378STK development board

Users Manual

Rev. C, July 2009
Copyright(c) 2009, OLIMEX Ltd, All rights reserved

INTRODUCTION:

LPC-2378STK is a starter kit which uses Microcontroller LPC2378 from NXP. This microcontroller supports various serial interfaces such as USB 2.0, UART, CAN, etc. In addition you will find also audio input and output, JTAG, Ethernet, TFT display and SD/MMC card holder on this board. All this along allow you to build a diversity of powerful applications to be used in a wide range of situations.

BOARD FEATURES:

- MCU: **LPC2378** 16/32 bit ARM7TDMI-S™t with 512K Bytes Program Flash, 16K Bytes RAM, EXTERNAL MEMORY BUS, RTC, 4x 10 bit ADC 2.44 uS, 2x UARTs, 4x CAN, I2C, SPI, 2x 32bit TIMERS, 7x CCR, 6x PWM, WDT, 5V tolerant I/O, up to 60MHz operation
- standard JTAG connector with ARM 2x10 pin layout for programming/debugging with ARM-JTAG
- Optional - TRACE connector
- 128x128 pixel 12 bit color TFT LCD with backlight
- Ethernet 100MBit
- MMA7620 3 axis accelerometer
- Two RS232 port
- Two CAN drivers and connector
- SD/MMC card connector
- UEXT connector with I2C, SPI, RS232 and power supply for connecting add-on modules like RF link, MP3, etc available from Olimex
- IrDA transceiver on board
- Audio in and Audio Out jacks for microphone and headphones
- trimpot connected to ADC
- RESET circuit with external control of Philips ISP utility via RS232 port
- Jumpers for ISP/RUN mode
- Joystick with four directions and push action
- two USER button
- RESET Button
- two on board voltage regulators 3V and 5V with up to 800mA current
- Extension port connector for many of microcontrollers pins
- single power supply: External power supply, USB or JTAG connector
- Battery holder and connector for the RTC
- power supply led
- FR-4, 1.5 mm, red soldermask, component print
- Dimensions: 134.60 x 101.27mm (5.3x3.99")

ELECTROSTATIC WARNING:

The LPC-2378STK board is shipped in protective anti-static packaging. The board must not be subject to high electrostatic potentials. General practice for working with static sensitive devices should be applied when working with this board.

BOARD USE REQUIREMENTS:

Cables: You will need different cables depending on the used programming/debugging tool. If you use Olimex's ARM-JTAG, you will need a LPT cable. If you use ARM-USB-OCD or ARM-USB-TINY,

you will need USB A-B cable. If you use a software programmer such as FlashMagic, you may need RS232 or other cables.

Hardware: Programmer/Debugger – **ARM-JTAG, ARM-USB-TINY** or **ARM-USB-OCD** or other compatible programming/debugging tool.

Software: You can use GCC or other commercial ARM compiler.

PROCESSOR FEATURES:

LPC-2378STK board use microcontroller **LPC2378** from NXP with these features:

- ARM7TDMI-S processor, running at up to 72 MHz.
- Up to 512 kB on-chip flash program memory with In-System Programming (ISP) and In-Application Programming (IAP) capabilities. Flash program memory is on the ARM local bus for high performance CPU access.
- 32 kB of SRAM on the ARM local bus for high performance CPU access.
- 16 kB SRAM for Ethernet interface. Can also be used as general purpose SRAM.
- 8 kB SRAM for general purpose DMA use also accessible by the USB.
- Dual Advanced High-performance Bus (AHB) system that provides for simultaneous Ethernet DMA, USB DMA, and program execution from on-chip flash with no contention between those functions. A bus bridge allows the Ethernet DMA to access the other AHB subsystem.
- EMC provides support for static devices such as flash and SRAM as well as off-chip memory mapped peripherals.
- Advanced Vectored Interrupt Controller (VIC), supporting up to 32 vectored interrupts.
- General Purpose AHB DMA controller (GPDMA) that can be used with the SSP serial interfaces, the I2S port, and the Secure Digital/MultiMediaCard (SD/MMC) card port, as well as for memory-to-memory transfers.
- Serial Interfaces:
 - Ethernet MAC with associated DMA controller. These functions reside on an independent AHB bus.
 - USB 2.0 full-speed device with on-chip PHY and associated DMA controller.
 - Four UARTs with fractional baud rate generation, one with modem control I/O, one with IrDA support, all with FIFO.

- CAN controller with two channels.
- SPI controller.
- Two SSP controllers, with FIFO and multi-protocol capabilities. One is an alternate for the SPI port, sharing its interrupt and pins. These can be used with the GPDMA controller.
- Three I2C-bus interfaces (one with open-drain and two with standard port pins).
- I²S (Inter-IC Sound) interface for digital audio input or output. It can be used with the GPDMA.
- Other peripherals:
 - SD/MMC memory card interface.
 - 104 General purpose I/O pins with configurable pull-up/down resistors.
 - 10-bit ADC with input multiplexing among 8 pins.
 - 10-bit DAC.
 - Four general purpose timers/counters with 8 capture inputs and 10 compare outputs. Each timer block has an external count input.
 - One PWM/timer block with support for three-phase motor control. The PWM has two external count inputs.
 - Real-Time Clock (RTC) with separate power pin, clock source can be the RTC oscillator or the APB clock.
 - 2 kB SRAM powered from the RTC power pin, allowing data to be stored when the rest of the chip is powered off.
 - WatchDog Timer (WDT). The WDT can be clocked from the internal RC oscillator, the RTC oscillator, or the APB clock.
- Standard ARM test/debug interface for compatibility with existing tools.
- Emulation trace module supports real-time trace.
- Single 3.3 V power supply (3.0 V to 3.6 V).
- Four reduced power modes: idle, sleep, power down, and deep power down.
- Four external interrupt inputs configurable as edge/level sensitive. All pins on PORT0 and PORT2 can be used as edge sensitive interrupt sources.

- Processor wake-up from Power-down mode via any interrupt able to operate during Power-down mode (includes external interrupts, RTC interrupt, USB activity, Ethernet wake-up interrupt).
- Two independent power domains allow fine tuning of power consumption based on needed features.
- Each peripheral has its own clock divider for further power saving.
- Brownout detect with separate thresholds for interrupt and forced reset.
- On-chip power-on reset.
- On-chip crystal oscillator with an operating range of 1 MHz to 24 MHz.
- 4 MHz internal RC oscillator trimmed to 1 % accuracy that can optionally be used as the system clock. When used as the CPU clock, does not allow CAN and USB to run.
- On-chip PLL allows CPU operation up to the maximum CPU rate without the need for a high frequency crystal. May be run from the main oscillator, the internal RC oscillator, or the RTC oscillator.
- Boundary scan for simplified board testing.
- Versatile pin function selections allow more possibilities for using on-chip peripheral functions.

BLOCK DIAGRAM:

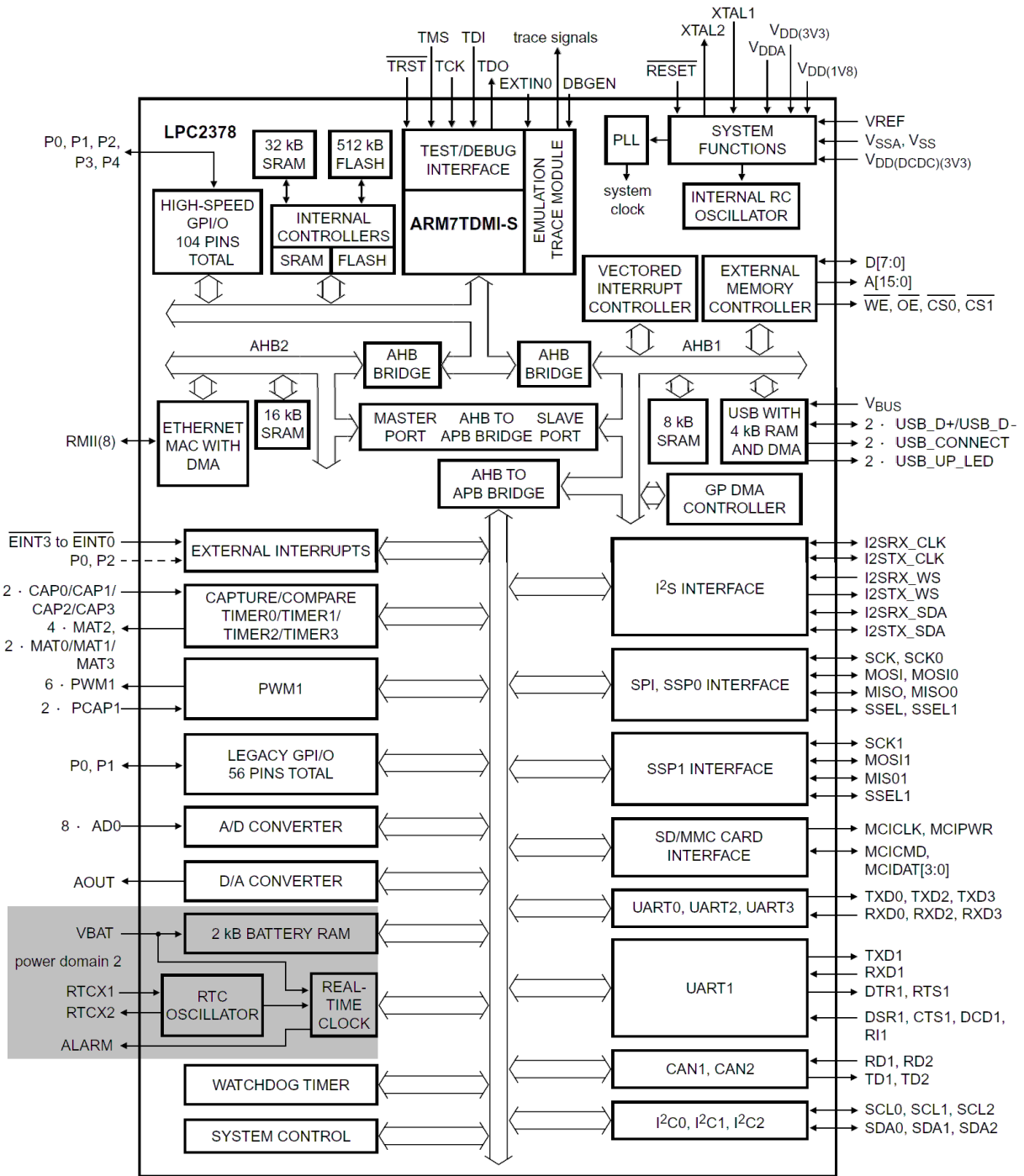

MEMORY MAP:

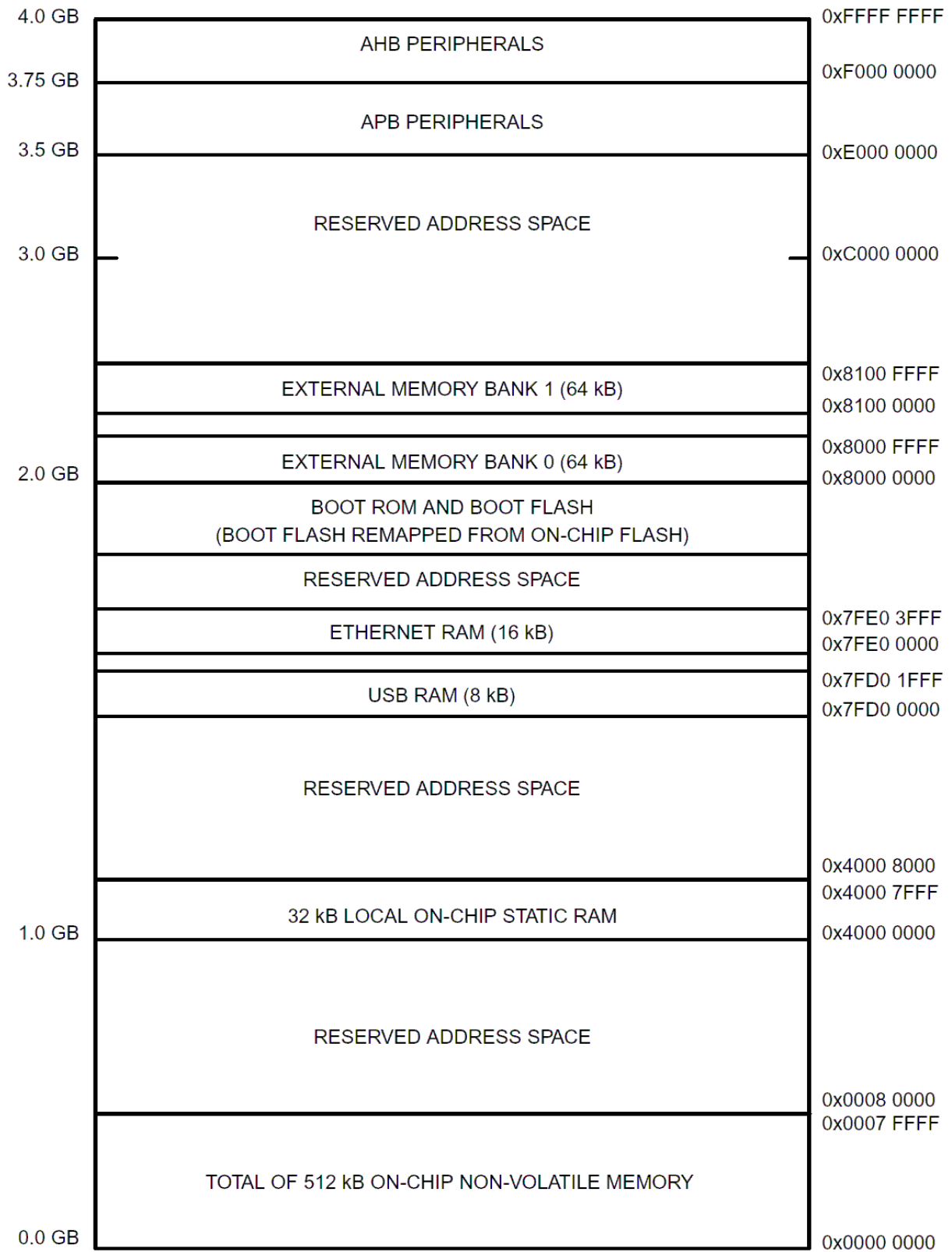

SCHEMATIC:

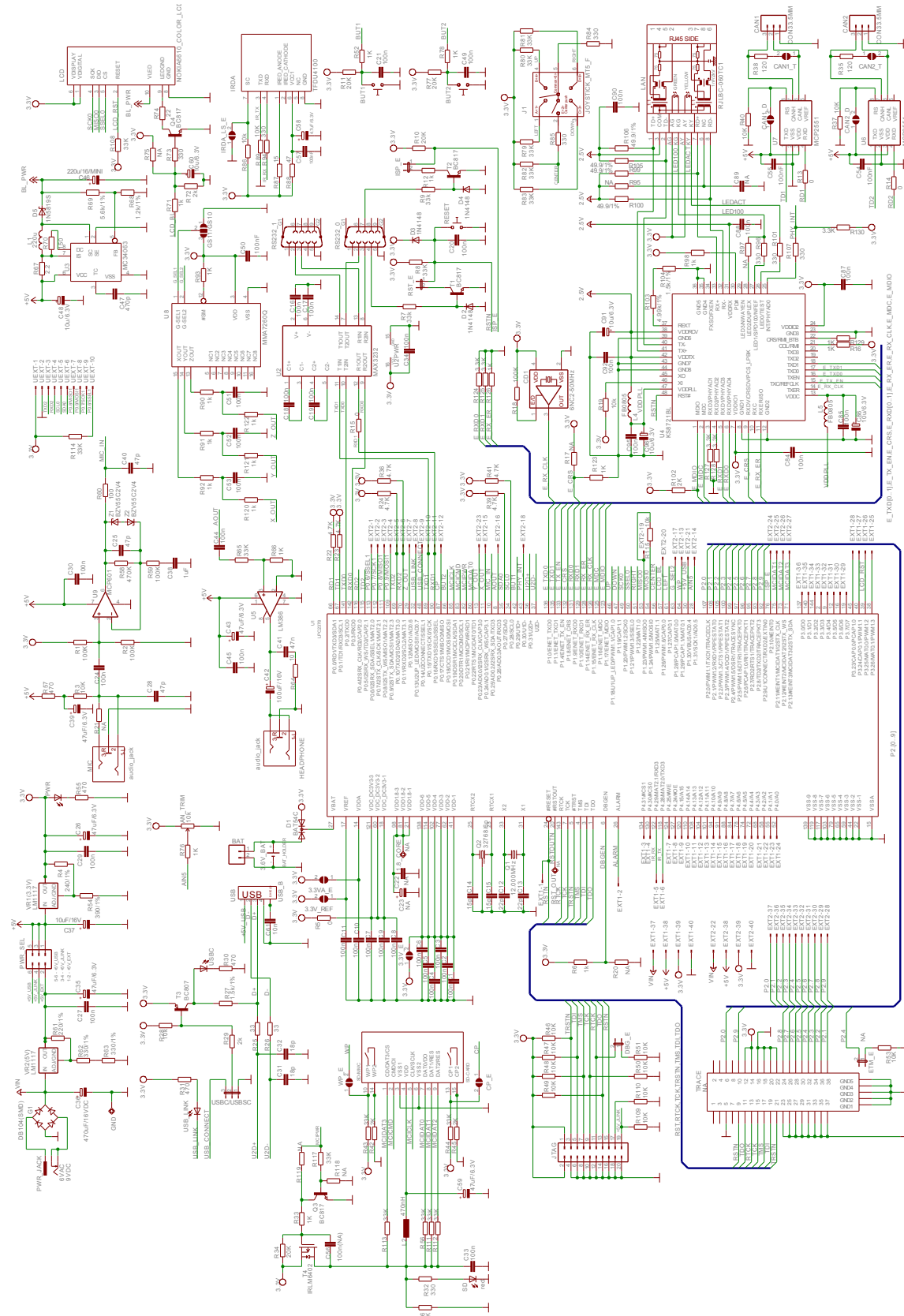

LPC-2378-STK
 Rev. C
 COPYRIGHT © 2009, OLIMEX LTD.
 http://www.olimex.com/rev

BOARD LAYOUT:

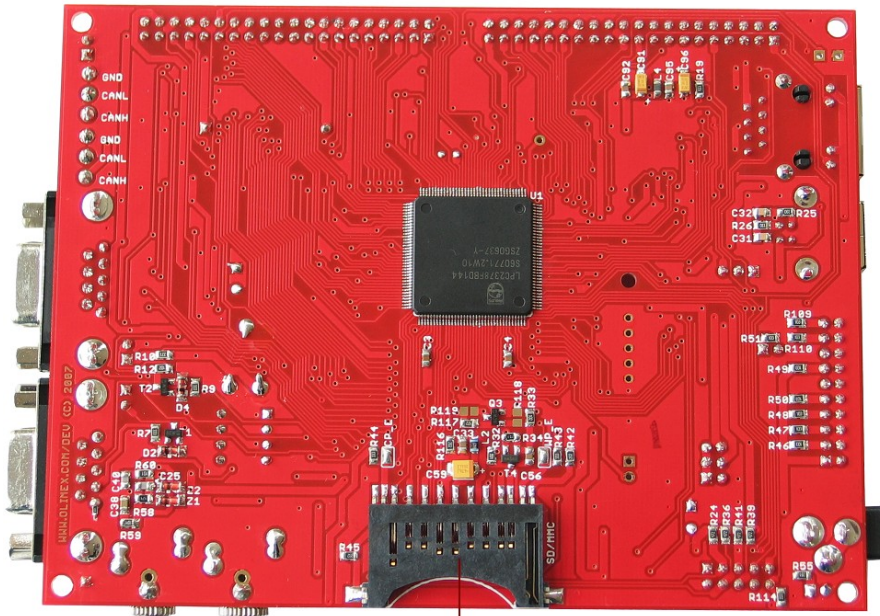
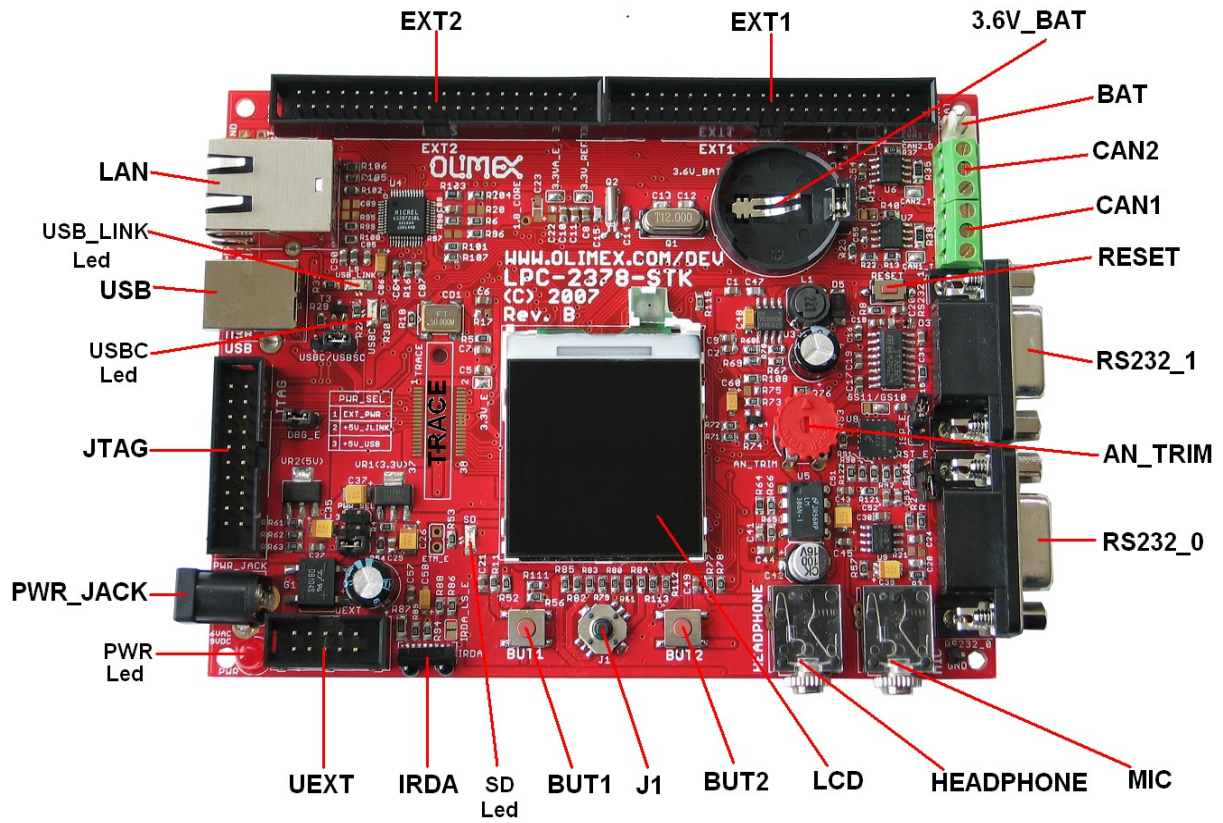

SD/MMC

POWER SUPPLY CIRCUIT:

LPC-2378STK is powered by 9VDC/6VAC applied at the power jack. LPC-2378STK could also be powered by USB (+5V_USB), JTAG (+5V_JLINK) and a battery (CR2032, Li, 3V) but this battery only powers the 2KB internal SRAM and the RTC (Real Time Clock).

The consumption of LPC-2378STK is about 190 mA.

RESET CIRCUIT:

LPC-2378STK reset circuit is made with R8 (33k) pull-up, capacitor C20(100nF), D3 (1N4148) and the RST button.

CLOCK CIRCUIT:

Quartz crystal Q1 12 MHz is connected to LPC2378 pin 31 (X1) and pin 33 (X2).

Quartz crystal Q2 32.768 kHz is connected to LPC2378 pin 23 (RTCX1) and pin 25 (RTCX2) and supplies the internal Real Time Clock.

JUMPER DESCRIPTION:

- There is jumpers description at our web page - to find it click [here](#)

INPUT/OUTPUT:

SD/MMC LED (red) with name **SD** connected to **SD/MMC** pin 4.

Power-on LED (red) with name **PWR** – this LED shows that +3.3V is applied to the board.

USB_CONNECTED LED (red) with name **USBC** – connected to **LPC2378** pin 48 (P0.14/U2CONNECT/SSEL1).

USB-UP LED (red) with name **USB_LINK** – connected to **LPC2378** pin 32 (P0.13/U2UP_LED/MOSI1/AD0.7).

User button with name **BUT1** connected to **LPC2378** pin 42 (P0.29/U1D+).

User button with name **BUT2** connected to **LPC2378** pin 86 (P0.18/DCD1/MOSI0/MOSI).

Reset button with name **RESET** connected to **LPC2378** pin 24 (#RESET).

Trimpot with name **AN_TRIM** connected to **LPC2378** pin 28 (P1.31/SCK1/AD0.5).

TFT display - 128x128 12 bit color with backlight.

Joystick button with name **J1** this is 4 directions plus center button, in the schematic the joystick four directions switches are connected through 33k resistors to **LPC2378** pins - 51 (P1.22/MAT1.0) – RIGHT, 61 (P1.27/CAP0.1) – LEFT, 47 (P1.19/CAP1.1) – DOWN, 46 (P1.18/U1UP_LED/PWM1.1/CAP1.0) – UP, the center button is connected to pin 56 (P1.25/MAT1.1).

EXTERNAL CONNECTORS DESCRIPTION:

JTAG:

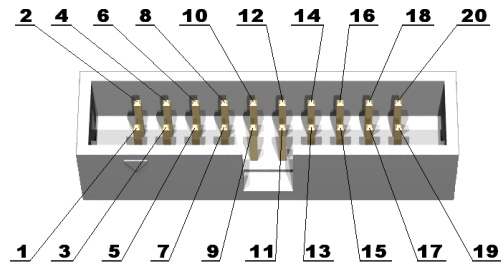

Pin #	Signal Name	Pin #	Signal Name
1	+3.3V	2	+3.3V
3	TRSTN	4	GND
5	TDI	6	GND
7	TMS	8	GND
9	TCK	10	GND
11	RTCK	12	GND
13	TDO	14	GND
15	RSTN	16	GND
17	Pull-down	18	GND
19	+5V_JLINK	20	GND

PWR JACK:

Pin #	Signal Name
1	Power Input
2	GND

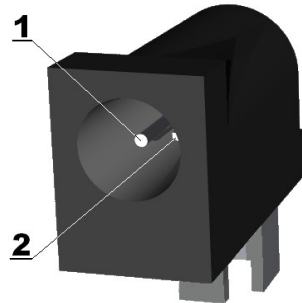

RS232 0:

Pin #	Signal Name
1	Not Connected
2	T2OUT
3	R2IN
4	This signal controls microcontroller reset signal
5	GND
6	Not Connected
7	This signal controls microcontroller ISP_E signal
8	Not Connected
9	Not Connected

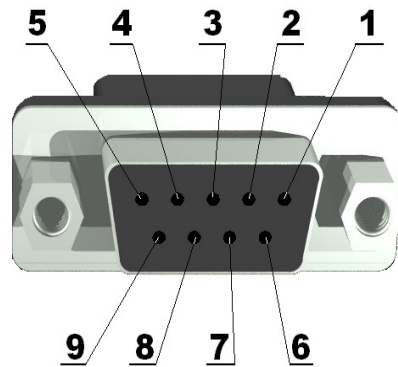

This is standard DB9 RS232 female type connector.

RS232 1:

Pin #	Signal Name
1	Not Connected
2	T1OUT
3	R1IN
4	Not Connected
5	GND
6	Not Connected
7	Not Connected
8	Not Connected
9	Not Connected

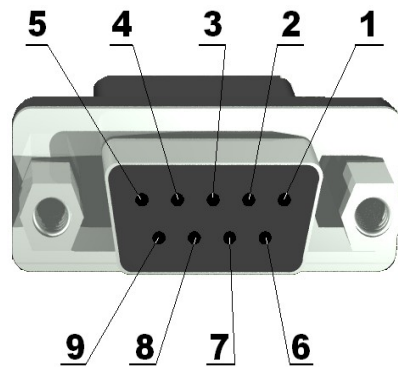

HEADPHONE:

Pin #	Signal Name
1-L	Audio Left OUT
2-C	GND
3-R	Audio Right OUT

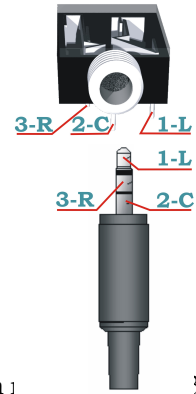

This is 3.5 mm Audio jack female connector and work with 3.5 mm jack headphones. Note the signal is Mono i.e. Left and Right channel info is same.

MIC:

Pin #	Signal Name
1-L	Audio Left IN
2-C	GND
3-R	Not Connected

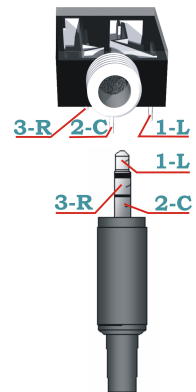

IrDA:

Pin #	Signal Name
1	+3.3V
2	NC
3	IR_TX (pull-down via R89(10k))
4	IR_RX
5	NC
6	+3.3V
7	NC 3.3V/GND – look at jumper IRDA_LS_E
8	GND

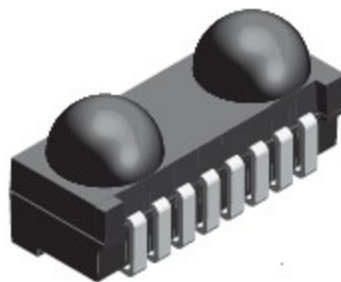

SD/MMC:

Pin #	Signal Name	Pin #	Signal Name
1	MCIDAT3	2	MCICMD
3	GND	4	MCIPWR
5	MCICLK	6	GND
7	MCIDAT0	8	MCIDAT1
9	MCIDAT2	10	Pull-up/WP
11	-	12	-
13	Pull-up/CP	14	Pull-down
15	Pull-down		

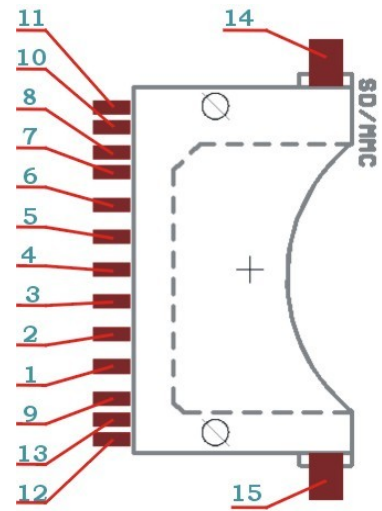

This is standard SD-MMC card connector.

CAN1:

Pin #	Signal Name
1	GND
2	CANL
3	CANH

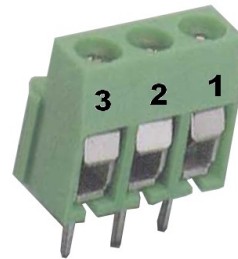

CANL and CANH are either differential input, or differential output depending on the function of the MCP2551 CAN controller (receiving or transmitting data).

CAN2:

Pin #	Signal Name
1	GND
2	CANL
3	CANH

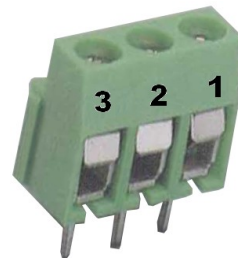

EXT1:

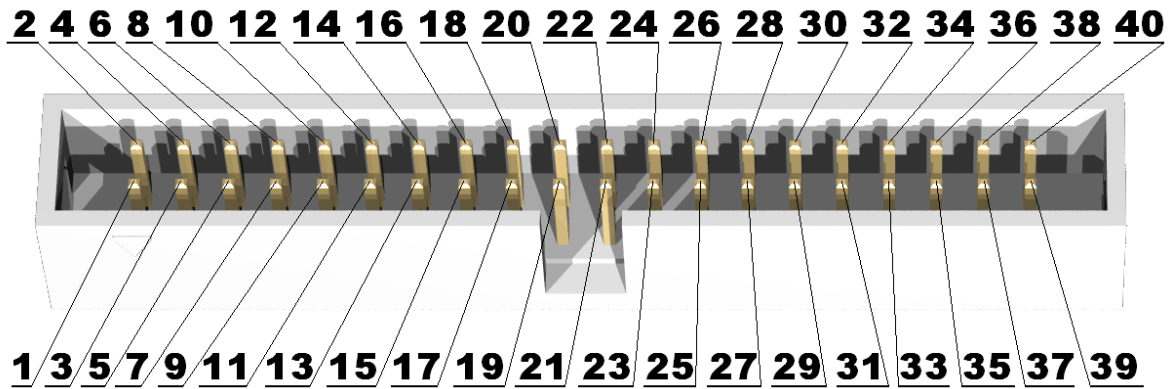

Pin #	Signal Name	Pin #	Signal Name
1	RSTN	2	ALARM
3	EXT1_3	4	EXT1_4
5	IR_RX	6	IR_TX
7	EXT1_7	8	EXT1_8
9	EXT1_9	10	EXT1_10
11	EXT1_11	12	EXT1_12
13	EXT1_13	14	EXT1_14
15	EXT1_15	16	EXT1_16
17	EXT1_17	18	EXT1_18
19	EXT1_19	20	EXT1_20
21	EXT1_21	22	EXT1_22
23	EXT1_23	24	EXT1_24
25	EXT1_25	26	LCD_RST
27	EXT1_27	28	EXT1_28
29	EXT1_29	30	EXT1_30
31	EXT1_31	32	EXT1_32
33	EXT1_33	34	EXT1_34
35	EXT1_35	36	EXT1_36
37	VIN	38	+5V
39	3.3V	40	GND

EXT2:

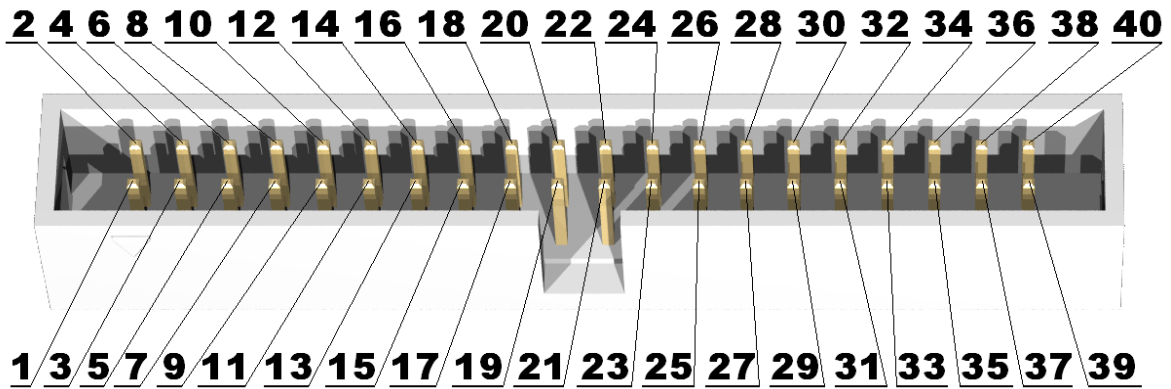

Pin #	Signal Name	Pin #	Signal Name
1	P0.6/SSEL1	2	P0.7/SCK1
3	P0.8/MISO1	4	P0.9/MOSI1
5	TXD2	6	RXD2
7	Z_OUT	8	USB_LINK
9	USB_CONNECT	10	TXD1
11	RXD1	12	CP
13	WP	14	AIN5
15	X_OUT	16	AOUT
17	G_SEL2	18	PHY_INT
19	MISO0	20	LCD_BL
21	+5V_USB	22	VIN
23	Y_OUT	24	ISP_E
25	MCIDAT1	26	MCIDAT2
27	MCIDAT3	28	P2.9
29	P2.8	30	P2.7
31	P2.6	32	P2.5
33	P2.4	34	P2.3
35	P2.2	36	P2.1
37	P2.0	38	+5V
39	3.3V	40	GND

UEXT:

Pin #	Signal Name
1	+3.3V
2	GND
3	TXD2
4	RXD2
5	SCL0
6	SDA0
7	P0.8/MISO1
8	P0.9/MOSI1
9	P0.7/SCK1
10	P0.6/SSEL1

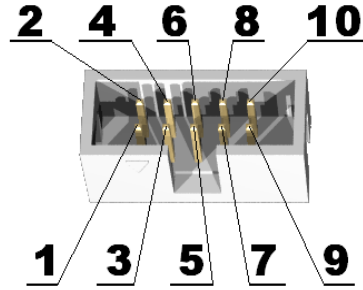

USB:

Pin #	Signal Name
1	+5V_USB
2	U2D-
3	U2D+
4	GND

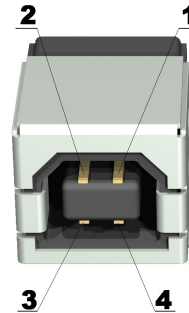

U1D-, U1D+ I/O This signals form the differential input/output depending on the direction of the data transfer.

BAT

Pin #	Signal Name
1	2V - 3.6V
2	GND

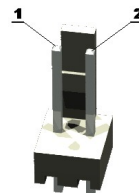

LAN:

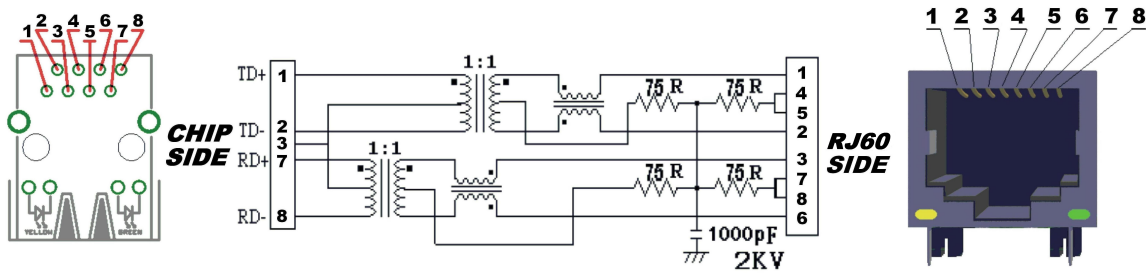

Pin #	Signal Name Chip Side	Pin #	Signal Name Chip Side
1	TD+	5	Not Connected (NC)
2	TD-	6	Not Connected (NC)
3	2.5V	7	RD+
4	Not Connected (NC)	8	RD-

LED	Color	Usage
Right	Yellow	Activity
Left	Green	100MBits/s (Half/Full duplex)

- TD-** Output Differential signal output. This signal is output from the MCU.
- TD+** Output Differential signal output. This signal is output from the MCU.
- RD-** Input Differential signal input. This signal is input for the MCU.
- RD+** Input Differential signal input. This signal is input for the MCU.

TRACE (optional):

The TRACE connector allows you to trace the execution of the programs.

MECHANICAL DIMENSIONS:

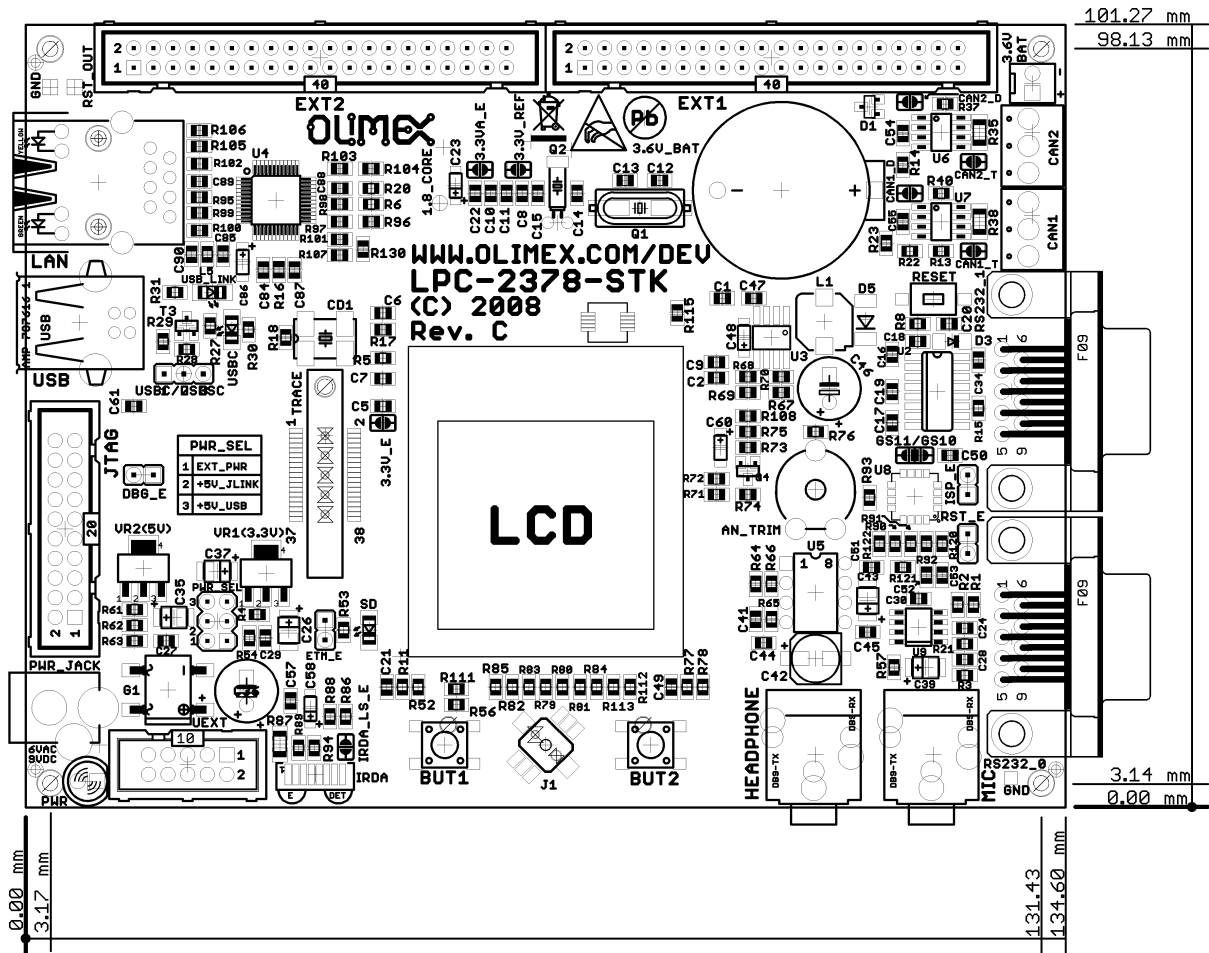

AVAILABLE DEMO SOFTWARE:

- AudioDevice_demo
- GettingStarted_demo
- LCD_Demo
- MassStorage_demo
- simple_demo
- uip_webserver_demo
- USBMouse_demo
- VirtualCom_demo

ORDER CODE:

LPC-2378STK – assembled and tested (no kit, no soldering required)

How to order?

You can order to us directly or by any of our distributors.

Check our web www.olimex.com/dev for more info.



All boards produced by Olimex are RoHS compliant

Revision history:

REV.C - created July 2009