

Series: Low Profile Transit

Description: Low Profile 617-3800MHz,  
NMO High Frequency mount, Monopole

PART NUMBER: LPT600/3800NMOHF (Black)  
LPT600/3800NMOHFW (White)



### Features:

- 4G / 5G LTE
- 617-960/1710-2170/  
2300-2700/3400-3800MHz
- Includes New Band 71 (617- 698  
MHz) and CBRS Bands 42 and  
48 (3.4-3.7 GHz)
- Omni radiation pattern
- Average peak gain  
3.8/5.2/5.6/5.5dBi
- Power rating 60W
- Size Dia. 40.9mm (1.61")
- Height 77.7mm (3.06")
- NMOHF Connector

### Applications:

- 4G / 5G (LTE)
- Utility boxes
- Smart metering
- IoT Devices

Issue: 1923

In the effort to improve our products, we reserve the right to make changes judged to be necessary.

CONFIDENTIAL AND PROPRIETARY INFORMATION

This document contains confidential and proprietary information of Pulse Electronics, Inc. (Pulse) and is protected by copyright, trade secret and other state and federal laws. Its receipt or possession does not convey any rights to reproduce, disclose its contents, or to manufacture, use or sell anything it may describe. Reproduction, disclosure or use without specific written authorization of Pulse is strictly forbidden.

For more information:

Pulse Worldwide Headquarters  
15255 Innovation Drive #100  
San Diego, CA 92128  
USA  
Tel: 1-858-674-8100

Pulse/Larsen Antennas  
18110 SE 34<sup>th</sup> St Bldg 2 Suite 250  
Vancouver, WA 98683  
USA  
Tel: 1-360-944-7551

Europe Headquarters  
Pulse GmbH & Do, KG  
Zeppelinstrasse 15  
Herrenberg, Germany  
Tel: 49 7032 7806 0

Pulse (Suzhou) Wireless Products Co, Inc.  
99 Huo Ju Road(#29 Bldg,4<sup>th</sup> Phase  
Suzhou New District  
Jiangsu Province, Suzhou 215009 PR China  
Tel: 86 512 6807 9998



Series: Low Profile Transit

**Description: Low Profile 617-3800MHz,  
NMO High Frequency mount, Monopole**

**PART NUMBER: LPT600/3800NMOHF (Black)  
LPT600/3800NMOHFW (White)**

### ELECTRICAL SPECIFICATIONS

Antenna type	Monopole, Measured on Ø1016mm (40") ground plane
Frequency	617-960/1710-2170/2300-2700/3400-3800 MHz
Nominal Impedance	50 Ω
VSWR (617-960/1710-2700/3400-3800)	3:1/2.5/2.5
Average peak gain (617-960/1710-2170/2300-2700/3400-3800)	3.8/5.2/5.6/5.5 dBi
Average efficiency (617-960/1710-2170/2300-2700/3400-3800)	85/82/83/80 %
Radiation Pattern	Omni
HPBW Vertical Plane (617-960/1710-2170/2300-2700/3400-3800)	45/30/23/32 °
Polarization	Vertical
Power withstanding	60 W

### MECHANICAL SPECIFICATIONS

Diameter / height	40.9 / 77.7mm (1.61" / 3.06")
Weight	63 g (.14lbs)
Antenna Color / Material	Black or White / UV Stabilized plastic
Connector	NMOHF
Mounting (required)	NMOHF

### ENVIRONMENTAL SPECIFICATIONS

Operating Temperature	-40° to +85° C
Ingress Protection	IP67
RoHS Compliant	Yes

### OTHER SPECIFICATIONS

Issue: 1923

In the effort to improve our products, we reserve the right to make changes judged to be necessary.

CONFIDENTIAL AND PROPRIETARY INFORMATION

This document contains confidential and proprietary information of Pulse Electronics, Inc. (Pulse) and is protected by copyright, trade secret and other state and federal laws. Its receipt or possession does not convey any rights to reproduce, disclose its contents, or to manufacture, use or sell anything it may describe. Reproduction, disclosure or use without specific written authorization of Pulse is strictly forbidden.

Series: Low Profile Transit

Description: Low Profile 617-3800MHz,  
NMO High Frequency mount, Monopole

PART NUMBER: LPT600/3800NMOHF (Black)  
LPT600/3800NMOHFW (White)

MECHANICAL DRAWING

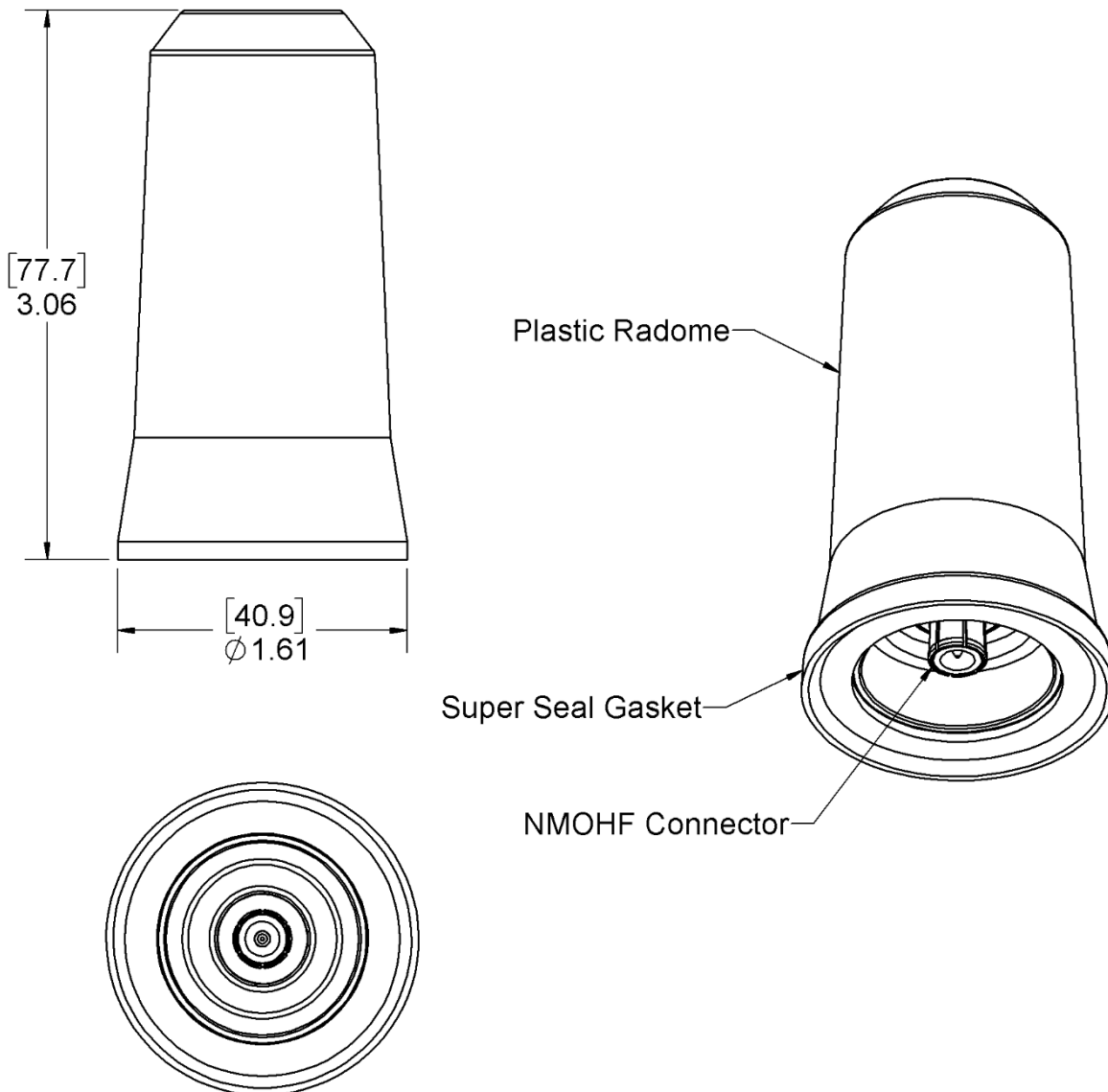

All dimensions are in mm / inches

Issue: 1923

In the effort to improve our products, we reserve the right to make changes judged to be necessary.

CONFIDENTIAL AND PROPRIETARY INFORMATION

This document contains confidential and proprietary information of Pulse Electronics, Inc. (Pulse) and is protected by copyright, trade secret and other state and federal laws. Its receipt or possession does not convey any rights to reproduce, disclose its contents, or to manufacture, use or sell anything it may describe. Reproduction, disclosure or use without specific written authorization of Pulse is strictly forbidden.

Series: Low Profile Transit

Description: Low Profile 617-3800MHz,  
 NMO High Frequency mount, Monopole

PART NUMBER: LPT600/3800NMOHF (Black)  
 LPT600/3800NMOHFW (White)

CHARTS

**VSWR vs Frequency**  
**LPT600/3800NMOHF Measured on Ø40" GP**  
 Measured at Pulse, USA - May 28, 2019

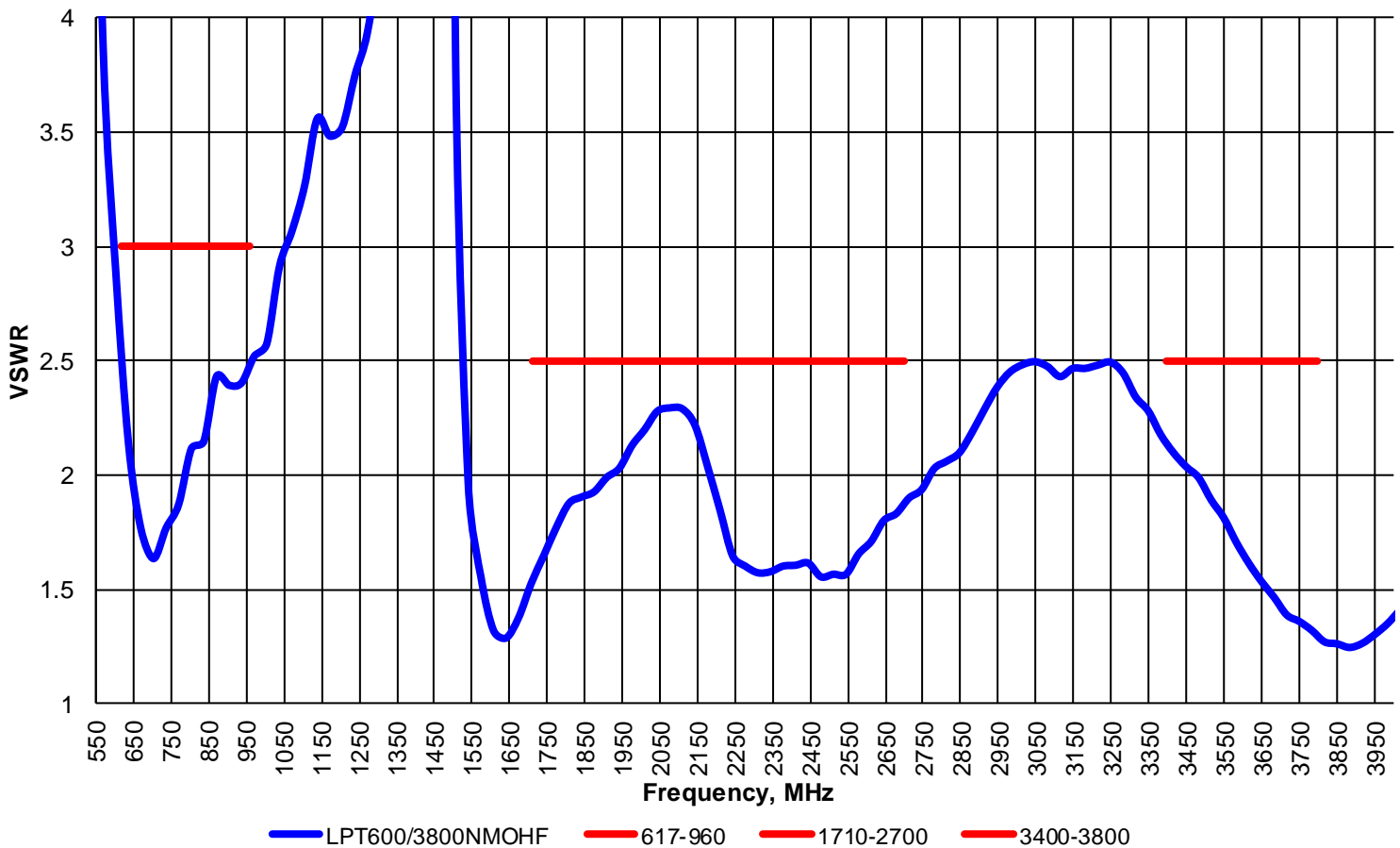

Issue: 1923

In the effort to improve our products, we reserve the right to make changes judged to be necessary.

CONFIDENTIAL AND PROPRIETARY INFORMATION

This document contains confidential and proprietary information of Pulse Electronics, Inc. (Pulse) and is protected by copyright, trade secret and other state and federal laws. Its receipt or possession does not convey any rights to reproduce, disclose its contents, or to manufacture, use or sell anything it may describe. Reproduction, disclosure or use without specific written authorization of Pulse is strictly forbidden.

Series: Low Profile Transit

Description: Low Profile 617-3800MHz,  
NMO High Frequency mount, Monopole

PART NUMBER: LPT600/3800NMOHF (Black)  
LPT600/3800NMOHFW (White)

CHARTS

Peak Gain vs Frequency  
LPT600/3800NMOHF Measured on Ø40" GP  
Measured at Pulse, USA - Nov 16, 2018

Measured on Ø40"  
Ground Plane  
No cable

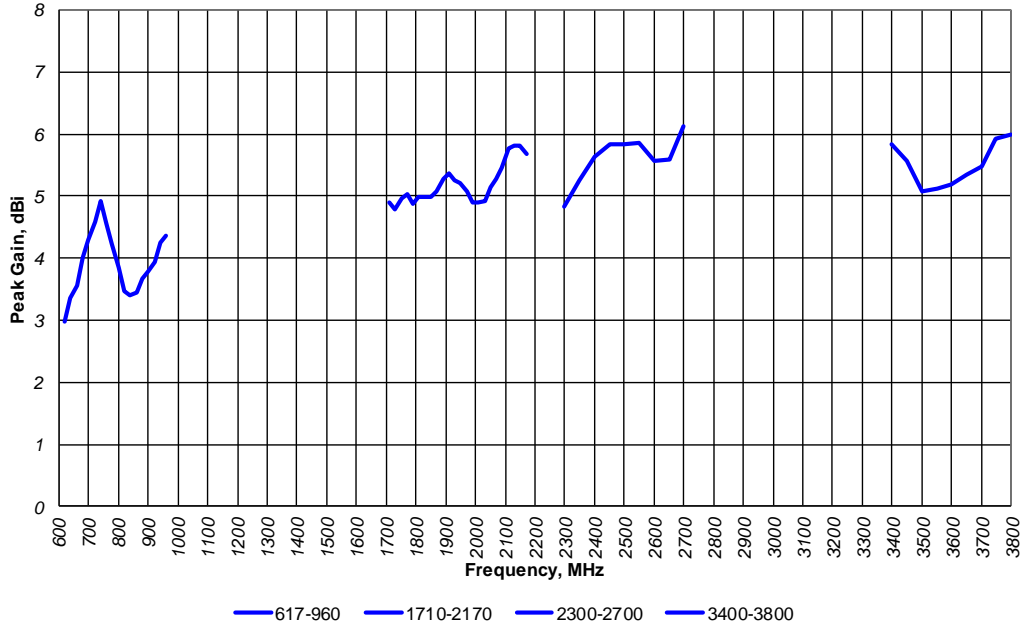

Efficiency vs Frequency  
LPT600/3800NMOHF Measured on Ø40" GP  
Measured at Pulse, USA - Nov 16, 2018

Measured on Ø40"  
Ground Plane  
No cable

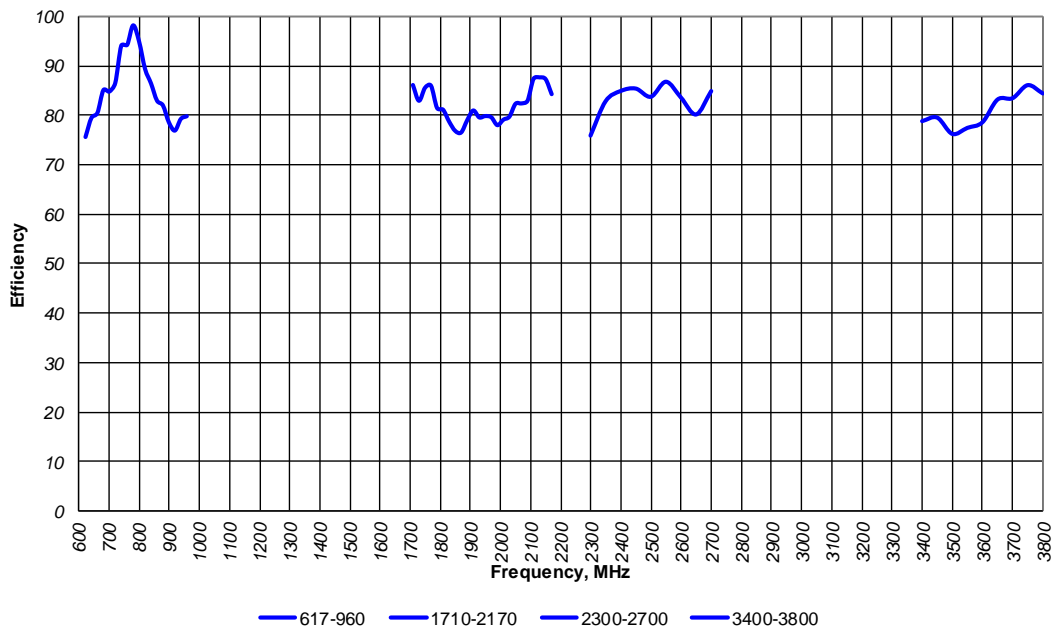

Issue: 1923

In the effort to improve our products, we reserve the right to make changes judged to be necessary.

CONFIDENTIAL AND PROPRIETARY INFORMATION

This document contains confidential and proprietary information of Pulse Electronics, Inc. (Pulse) and is protected by copyright, trade secret and other state and federal laws. Its receipt or possession does not convey any rights to reproduce, disclose its contents, or to manufacture, use or sell anything it may describe. Reproduction, disclosure or use without specific written authorization of Pulse is strictly forbidden.

**Description: Low Profile 617-3800MHz,  
NMO High Frequency mount, Monopole**

**Series: Low Profile Transit**

**PART NUMBER: LPT600/3800NMOHF (Black)  
LPT600/3800NMOHFW (White)**

**CHARTS**

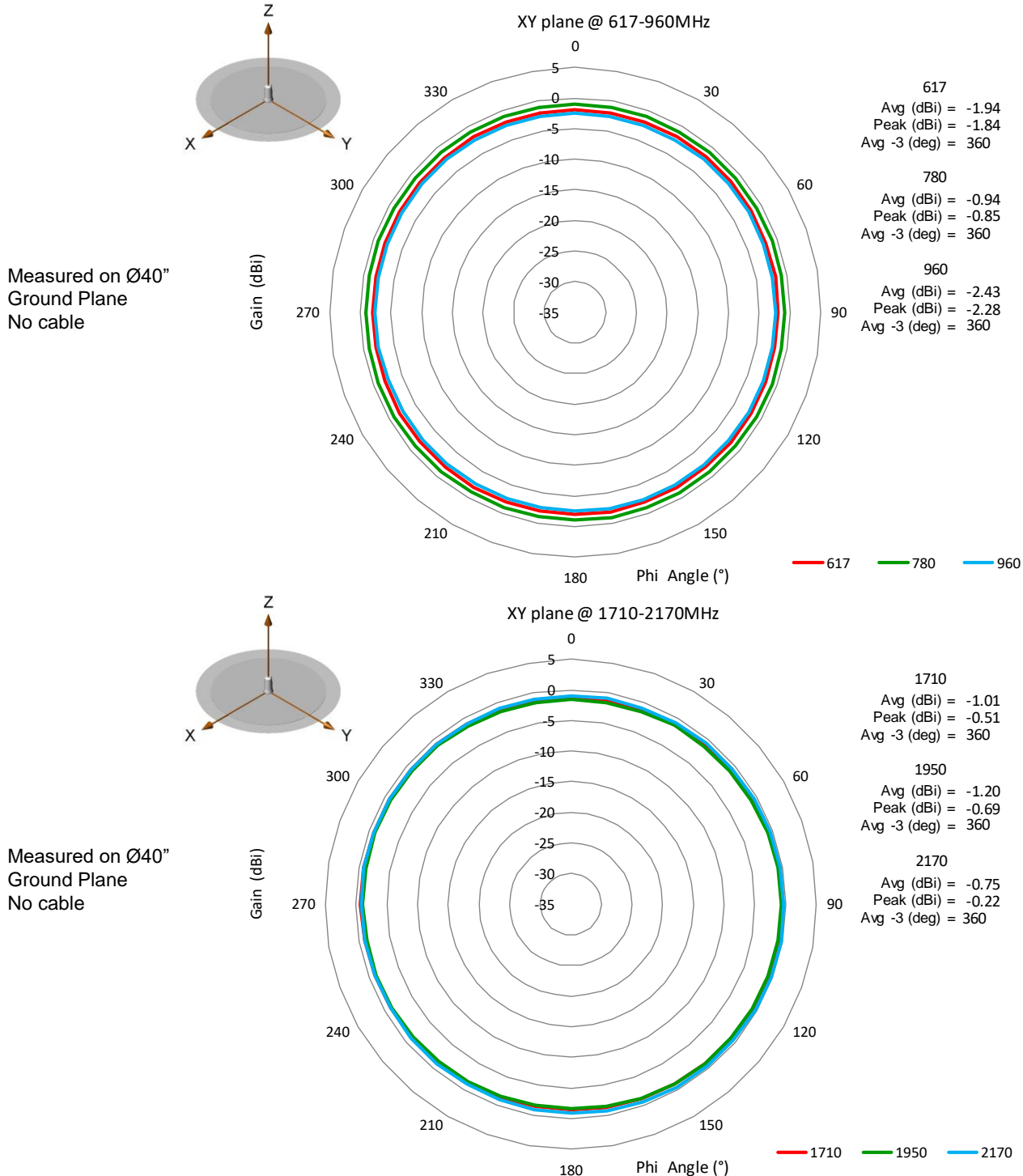

Issue: 1923

In the effort to improve our products, we reserve the right to make changes judged to be necessary.

CONFIDENTIAL AND PROPRIETARY INFORMATION

This document contains confidential and proprietary information of Pulse Electronics, Inc. (Pulse) and is protected by copyright, trade secret and other state and federal laws. Its receipt or possession does not convey any rights to reproduce, disclose its contents, or to manufacture, use or sell anything it may describe. Reproduction, disclosure or use without specific written authorization of Pulse is strictly forbidden.

**Description: Low Profile 617-3800MHz,  
NMO High Frequency mount, Monopole**

**Series: Low Profile Transit**

**PART NUMBER: LPT600/3800NMOHF (Black)  
LPT600/3800NMOHFW (White)**

**CHARTS**

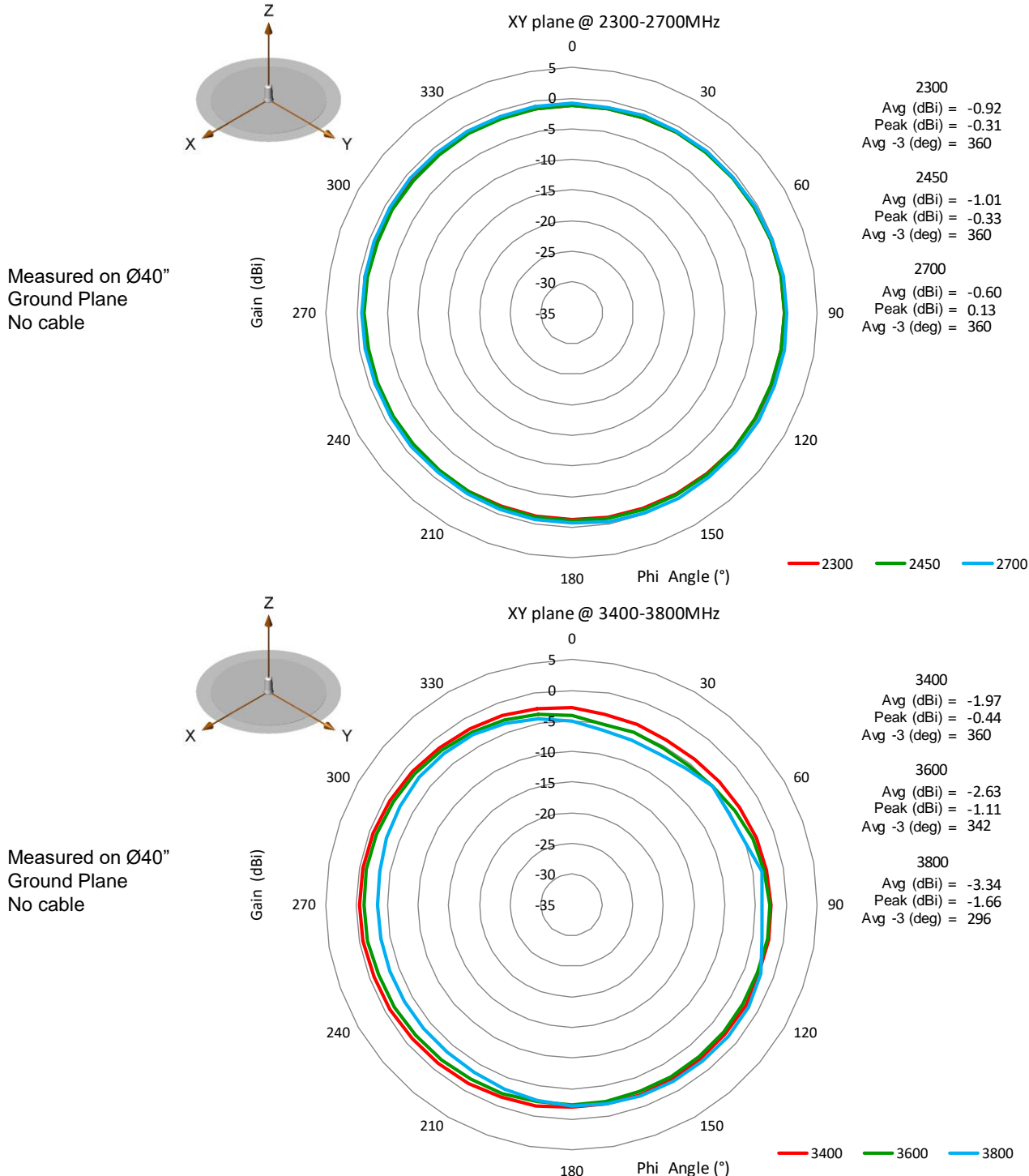

Issue: 1923

In the effort to improve our products, we reserve the right to make changes judged to be necessary.

CONFIDENTIAL AND PROPRIETARY INFORMATION

This document contains confidential and proprietary information of Pulse Electronics, Inc. (Pulse) and is protected by copyright, trade secret and other state and federal laws. Its receipt or possession does not convey any rights to reproduce, disclose its contents, or to manufacture, use or sell anything it may describe. Reproduction, disclosure or use without specific written authorization of Pulse is strictly forbidden.

**Description: Low Profile 617-3800MHz,  
NMO High Frequency mount, Monopole**

**Series: Low Profile Transit**

**PART NUMBER: LPT600/3800NMOHF (Black)  
LPT600/3800NMOHFW (White)**

**CHARTS**

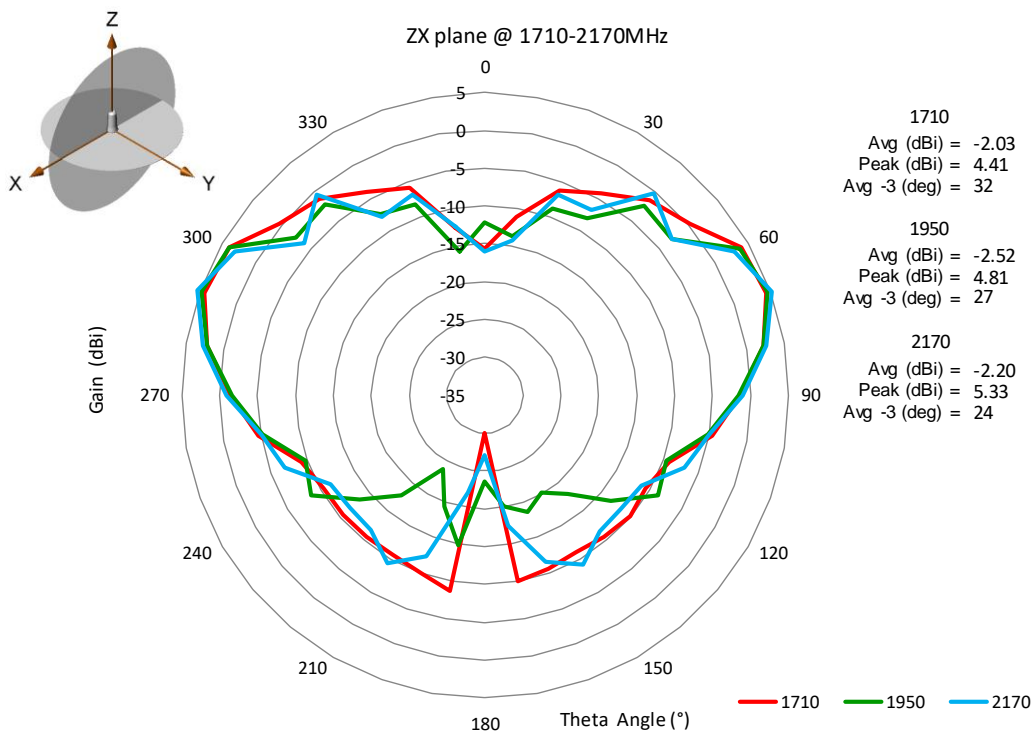
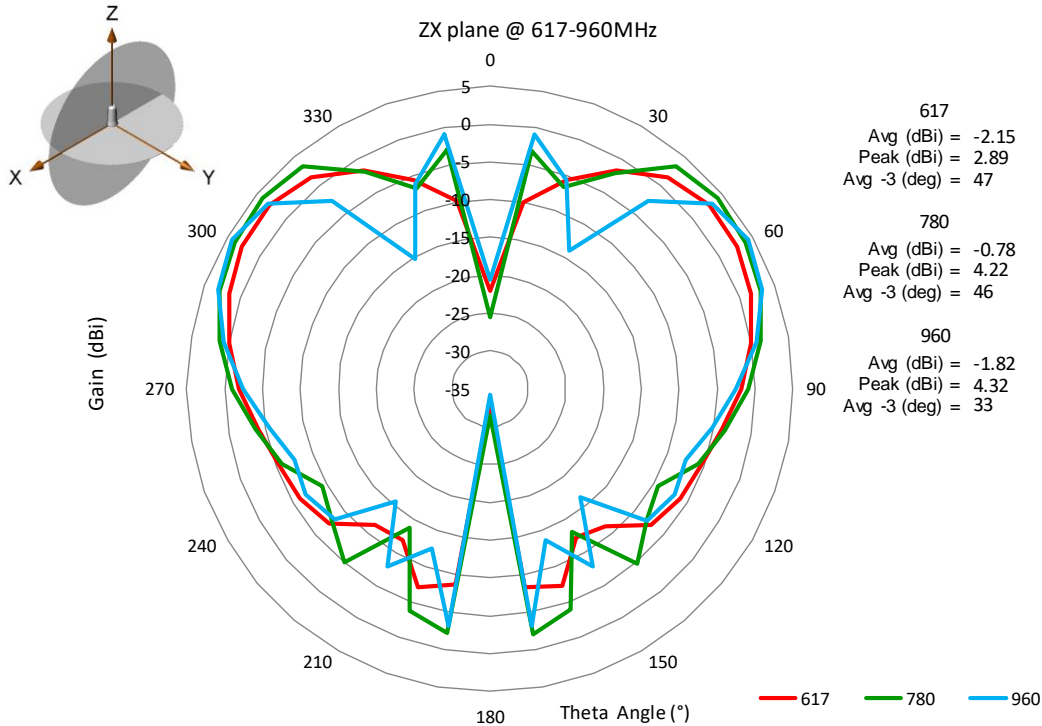

Issue: 1923

In the effort to improve our products, we reserve the right to make changes judged to be necessary.

CONFIDENTIAL AND PROPRIETARY INFORMATION

This document contains confidential and proprietary information of Pulse Electronics, Inc. (Pulse) and is protected by copyright, trade secret and other state and federal laws. Its receipt or possession does not convey any rights to reproduce, disclose its contents, or to manufacture, use or sell anything it may describe. Reproduction, disclosure or use without specific written authorization of Pulse is strictly forbidden.



**Description: Low Profile 617-3800MHz,  
NMO High Frequency mount, Monopole**

**Series: Low Profile Transit**

**PART NUMBER: LPT600/3800NMOHF (Black)  
LPT600/3800NMOHFW (White)**

**CHARTS**

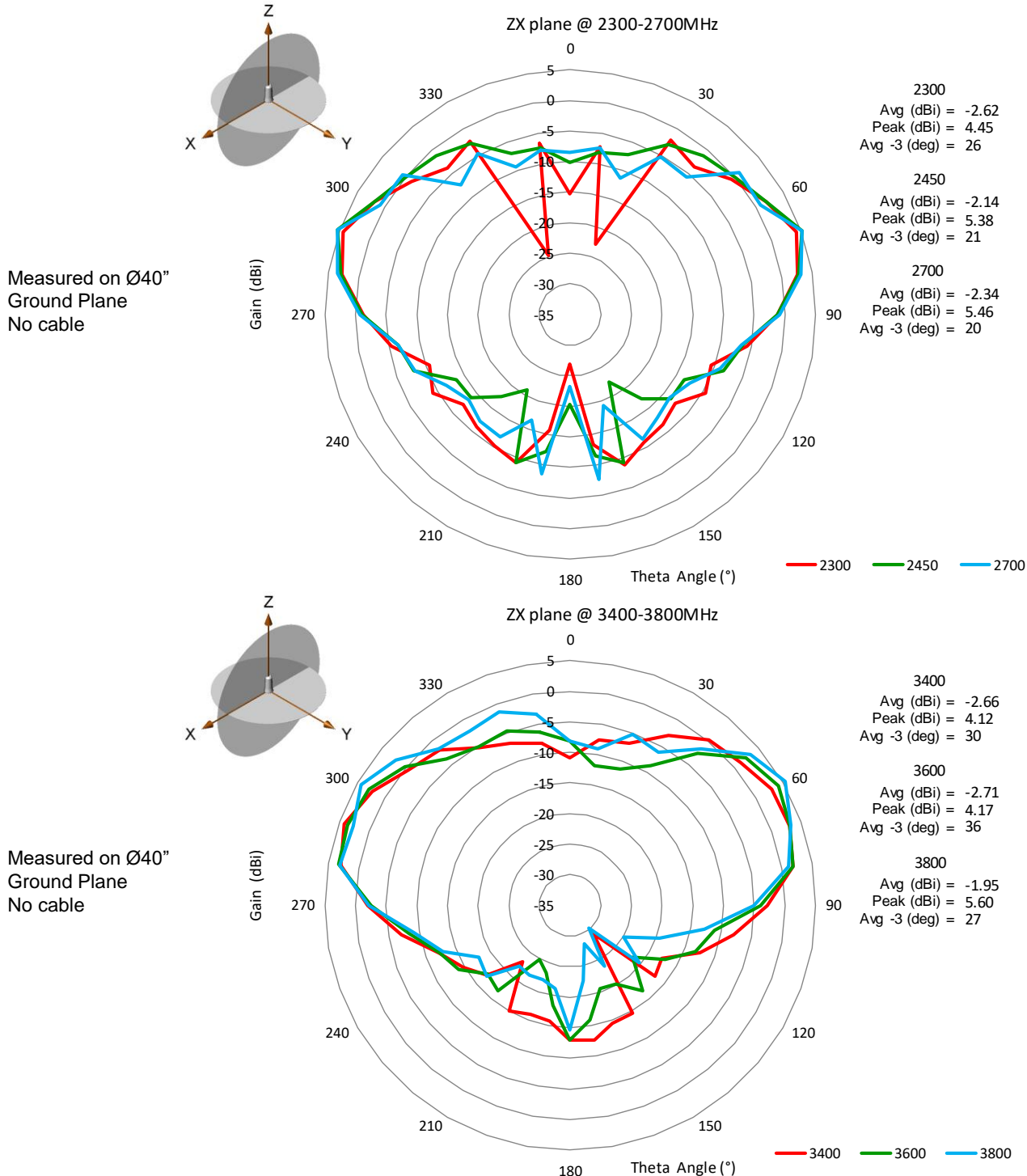

Issue: 1923

In the effort to improve our products, we reserve the right to make changes judged to be necessary.

CONFIDENTIAL AND PROPRIETARY INFORMATION

This document contains confidential and proprietary information of Pulse Electronics, Inc. (Pulse) and is protected by copyright, trade secret and other state and federal laws. Its receipt or possession does not convey any rights to reproduce, disclose its contents, or to manufacture, use or sell anything it may describe. Reproduction, disclosure or use without specific written authorization of Pulse is strictly forbidden.