





# Outdoor 5G/4G Direct Mount Salt Shaker Monopole Antenna

LPT600/71DMN and LPT600/71DMNW – 617 to 7125 MHz



## Features & Applications:

-  WiFi 6E, 4G/5G FR1
-  Includes Band 71 (617-698MHz) and CBRs Bands 42 and 48 (3.4-3.7GHz)
-  Utility boxes
-  Smart metering
-  IoT Devices

### Electrical specifications @ 25° C

Frequency Bands – 617-960/1710-2700/3300-4200/4400-5000/5150-5925/6000-7125 MHz

Antenna type <sup>2</sup>	Nominal Impedance	Polarization	Radiation pattern	Power withstanding	DC Ground
Monopole	50Ω	Vertical	Omni	60W	No

Frequency (MHz)	617-960	1710-2700	3300-4200	4400-5000	5150-5925	6000-7125
VSWR	3:1	2:1	2.5:1	2.5:1	2:1	2:1
Average Peak Gain (dBi)	2.3	4.7	5.0	5.7	6.1	6.9
Average Efficiency (%)	82	84	81	67	75	67
HPBW Vertical Plane (°)	65	43	31	25	28	26

### Mechanical Specifications

LPT600/71DMN or LPT600/71DMNW<sup>3</sup>

Size (Diameter x Height)	Color	Weight	Connector Type	Fixing System <sup>4</sup>
40.9 (1.61") x 95.9 (3.77") mm	Black or White	163grms (0.36lbs)	N-Female	Direct Mount
Housing Material	Operating Temperature	Ingress Protection	RoHS-6 Compliant	
PET+PC, UV rated	-40°C to +85°C	IP67	Yes	

#### Notes:

1. Storage Temperature: -40°C to 85°C
2. Measured on 305mm (12") SQ ground plane
3. LPT600/71DMN comes in black, for white add the suffix W and PN becomes LPT600/71DMNW
4. Ø15.9mm (0.625") mounting hole required.

# Outdoor 5G/4G Direct Mount Salt Shaker Monopole Antenna

LPT600/71DMN and LPT600/71DMNW – 617 to 7125 MHz

## Mechanical Drawing

LPT600/71DMN (W)

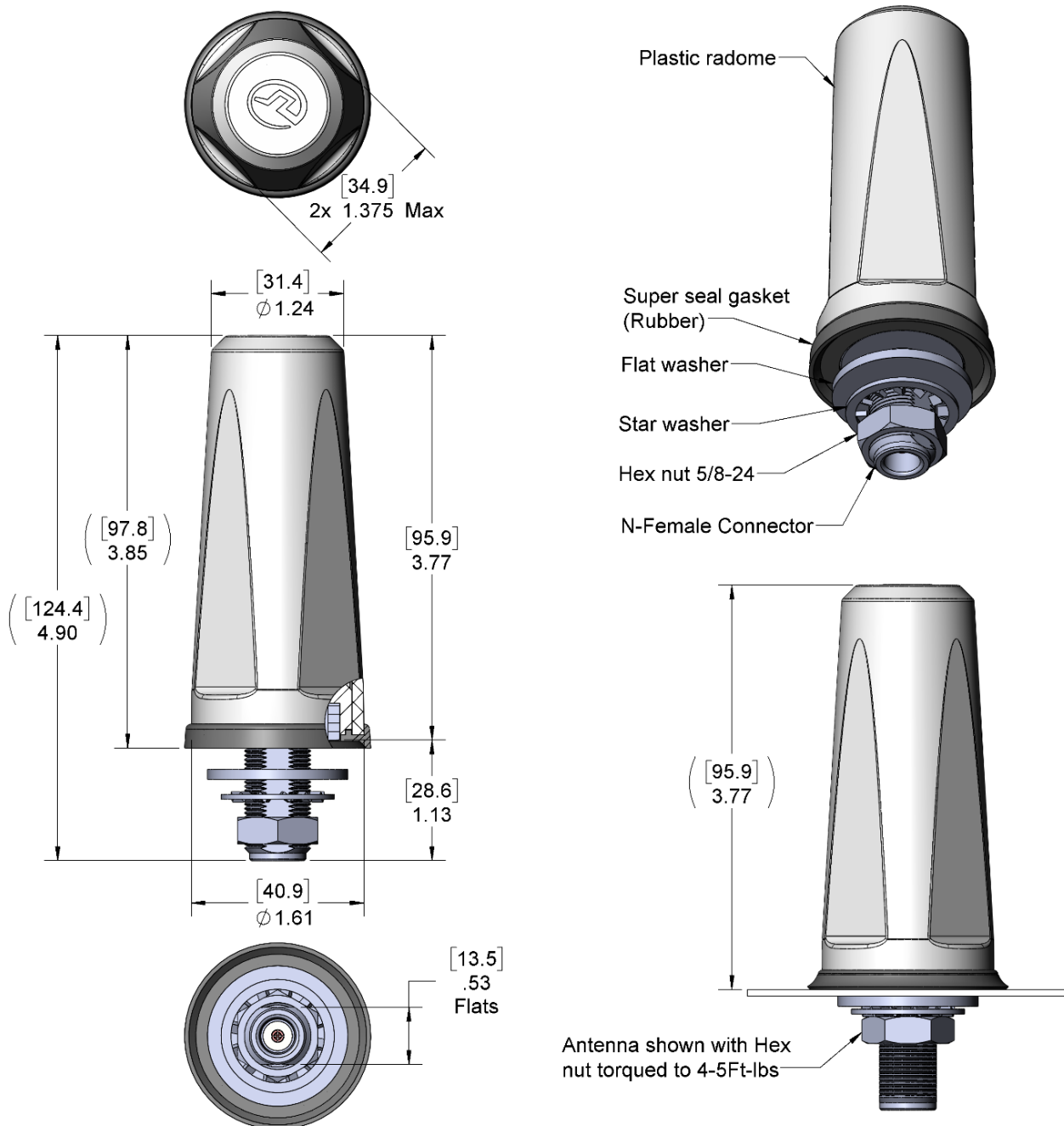

**Dimensions:** Inches (mm)

Unless otherwise specified, all tolerances are  $\pm .010$  (0.25mm)

### Test Setup

LPT600/71DMN (W)

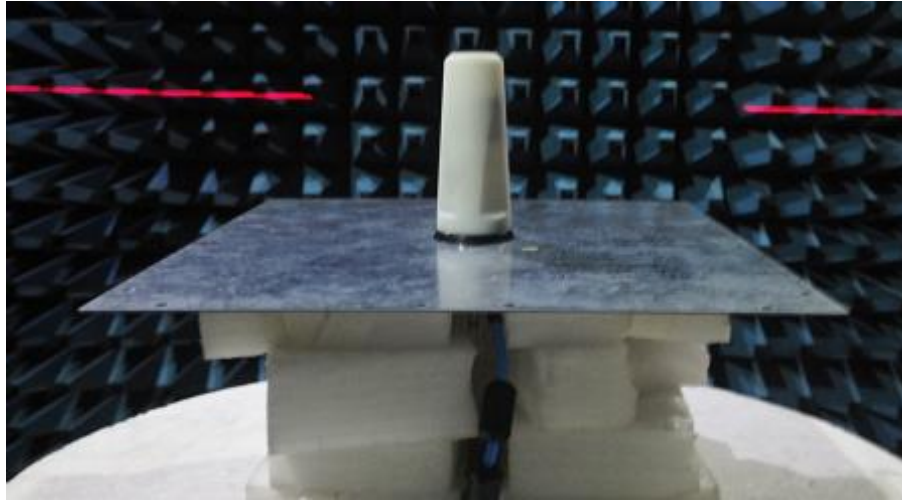

LPT600/71DMN antenna sample measured on 12" (305mm) SQ ground plane.

### Charts- VSWR

LPT600/71DMN (W)

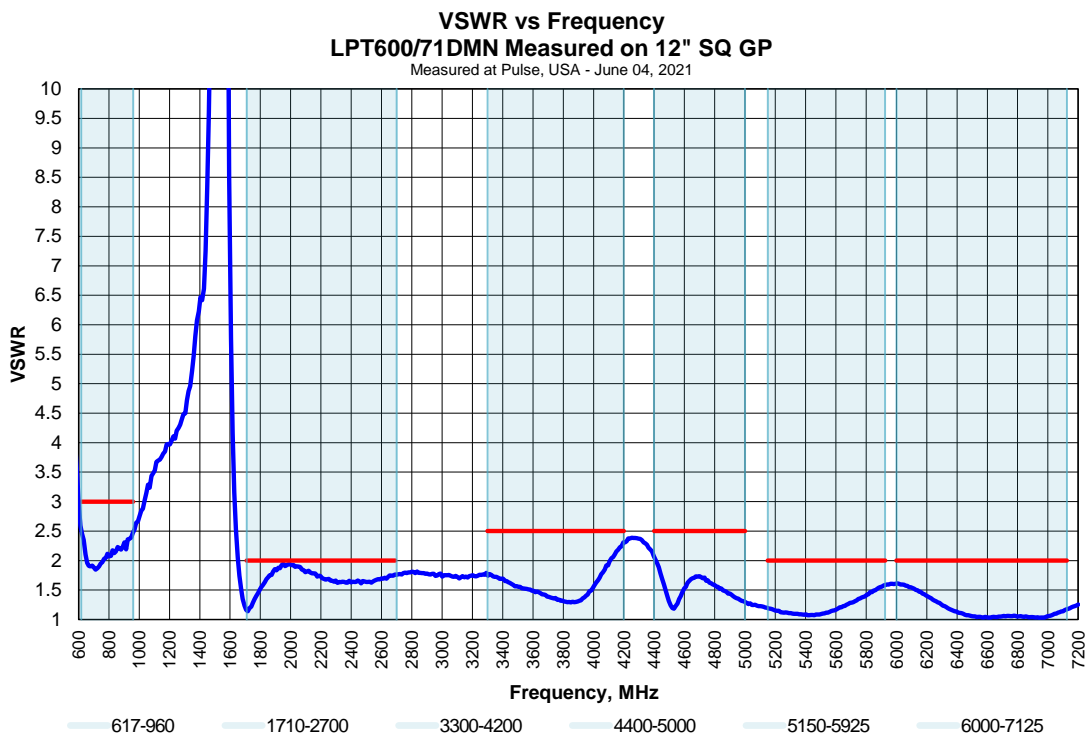

Charts- Peak Gain and Efficiency

LPT600/71DMN (W)

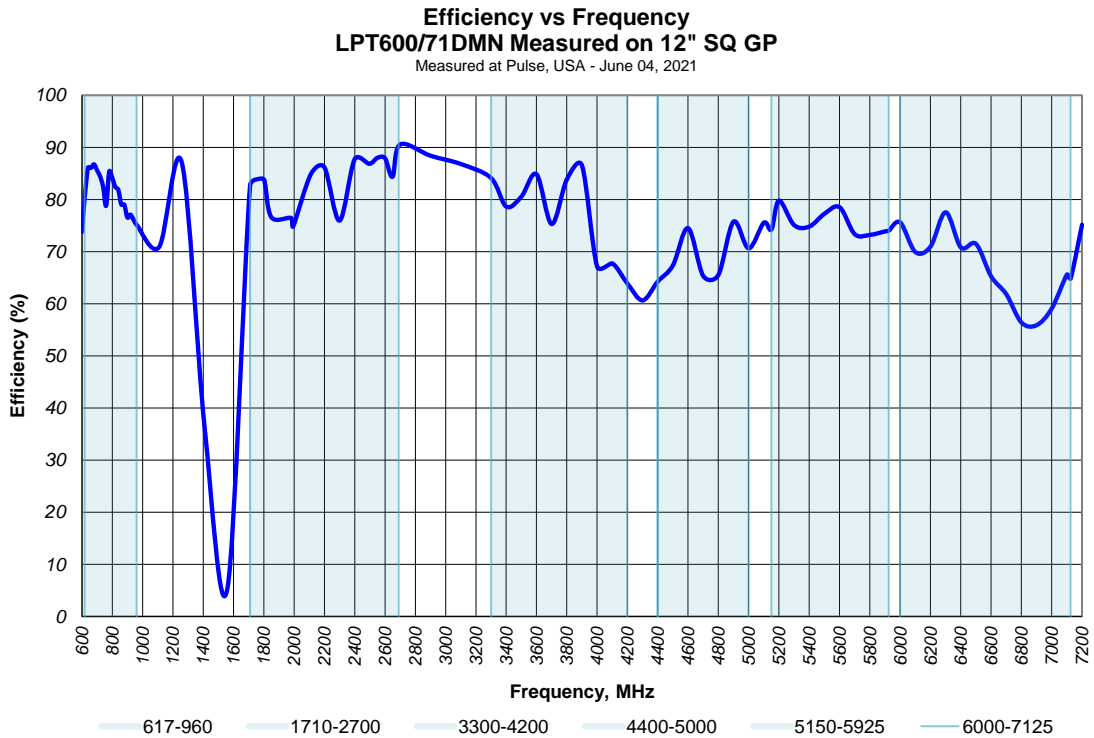
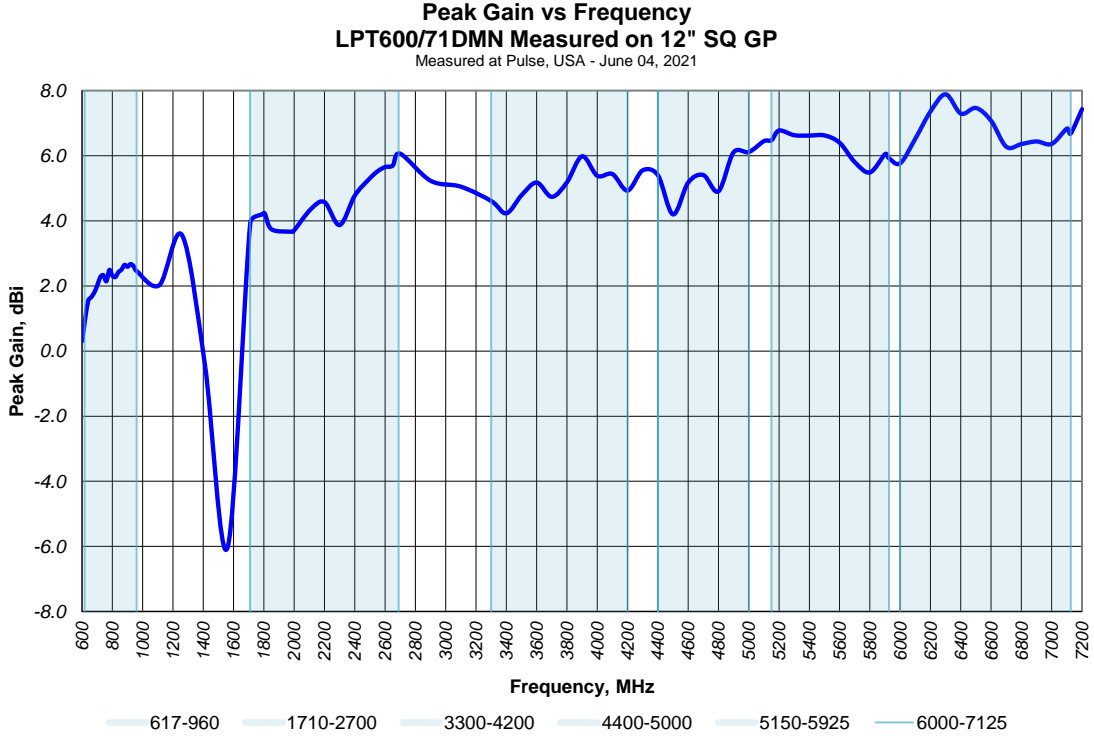

Charts- XY Gain Plots

LPT600/71DMN (W)

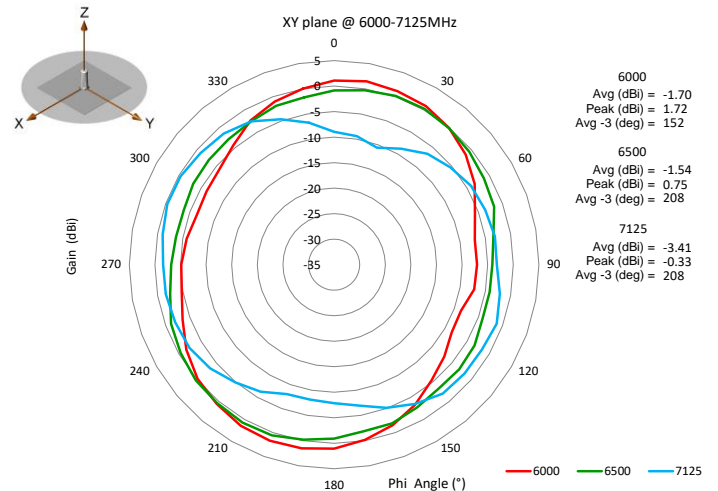
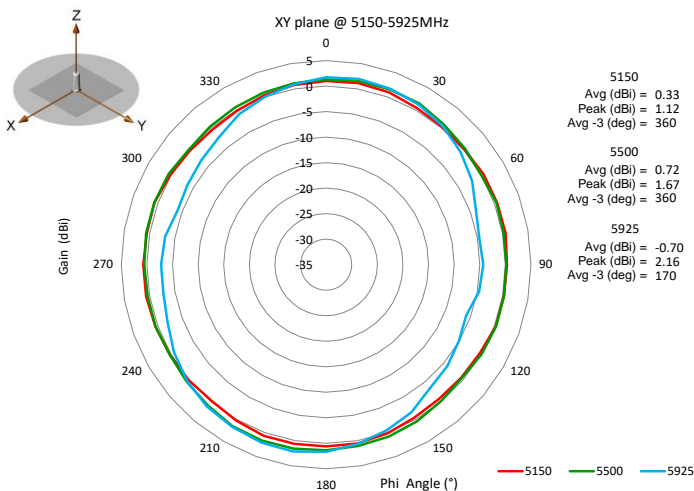
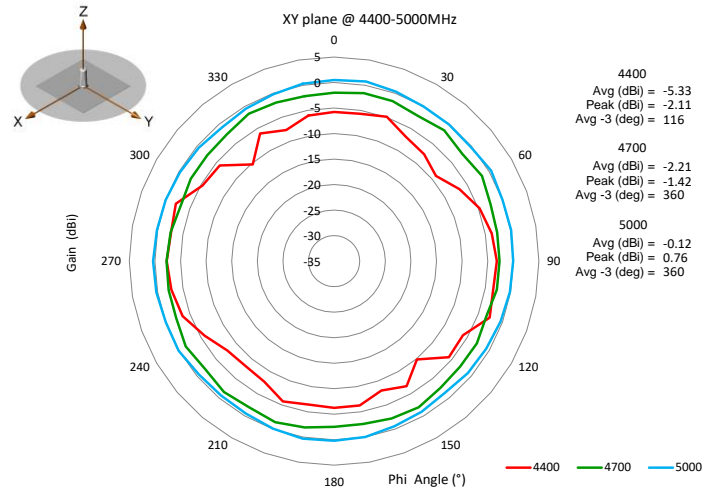
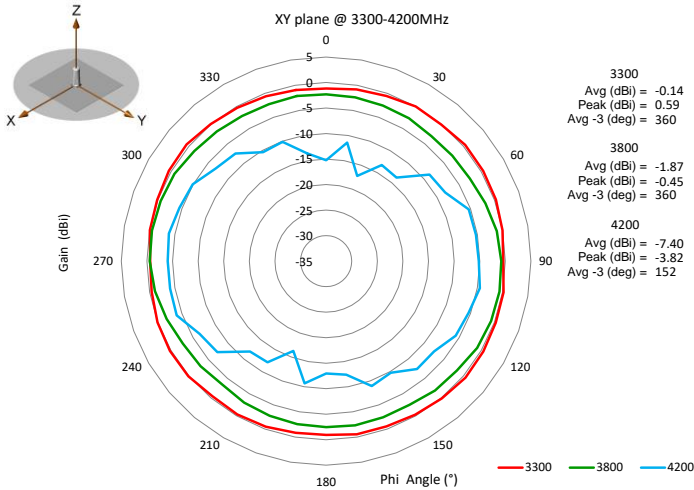
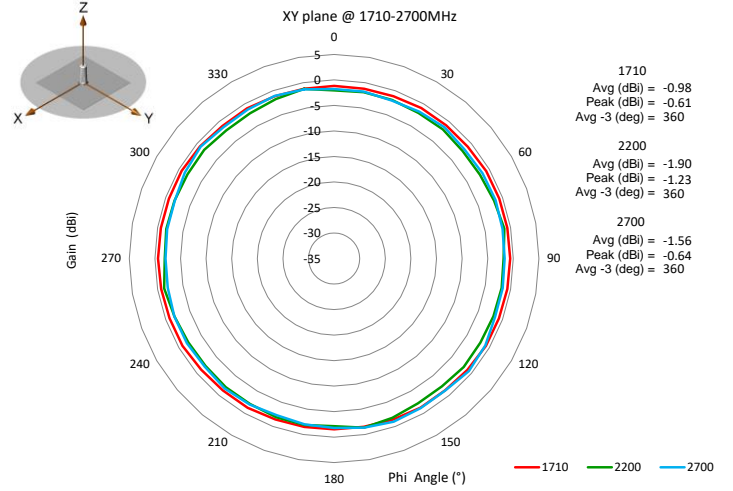
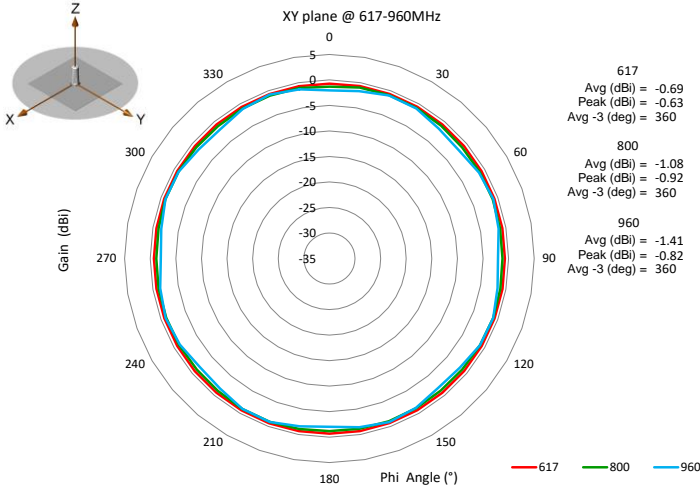

Charts – XZ Gain Plots

LPT600/71DMN (W)

