

FEATURES

- 10mA Max Supply Current
- ESD Protection over ± 10 kV
- Uses Small Capacitors: 0.1 μ F
- 120kbaud Operation for $R_L = 3k$, $C_L = 2500pF$
- 250kbaud Operation for $R_L = 3k$, $C_L = 1000pF$
- Outputs Withstand ± 30 V Without Damage
- CMOS Comparable Low Power: 40mW
- Operates from a Single 5V Supply
- Rugged Bipolar Design
- Outputs Assume a High Impedance State When Off or Powered Down
- Meets All RS232 Specifications
- Available With or Without Shutdown
- Absolutely No Latch-up
- Available in SO Package

APPLICATIONS

- Portable Computers
- Battery-Powered Systems
- Power Supply Generator
- Terminals
- Modems

DESCRIPTION

The LT[®]1280A/LT1281A are dual RS232 driver/receiver pairs with integral charge pump to generate RS232 voltage levels from a single 5V supply. These circuits feature rugged bipolar design to provide operating fault tolerance and ESD protection unmatched by competing CMOS designs. Using only 0.1 μ F external capacitors, these circuits consume only 40mW of power, and can operate to 120kbaud even while driving heavy capacitive loads. New ESD structures on the chip allow the LT1280A/LT1281A to survive multiple ± 10 kV strikes, eliminating the need for costly TransZorbs[®] on the RS232 line pins. The LT1280A/LT1281A are fully compliant with EIA RS232 standards. Driver outputs are protected from overload, and can be shorted to ground or up to ± 30 V without damage. During shutdown or power-off conditions, driver and receiver outputs are in a high impedance state, allowing line sharing.

The LT1281A is available in 16-pin DIP and SO packages. The LT1280A is supplied in 18-pin DIP and SO packages for applications which require shutdown.

 LTC and LT are registered trademarks of Linear Technology Corporation. TransZorb is a registered trademark of General Instruments, GSI

TYPICAL APPLICATION

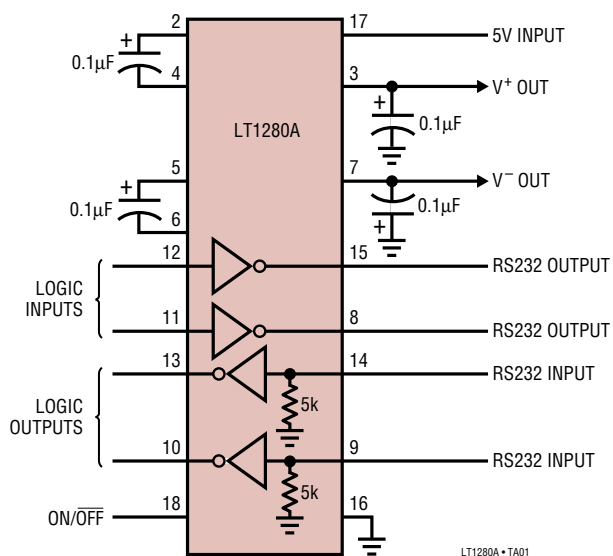

Output Waveforms

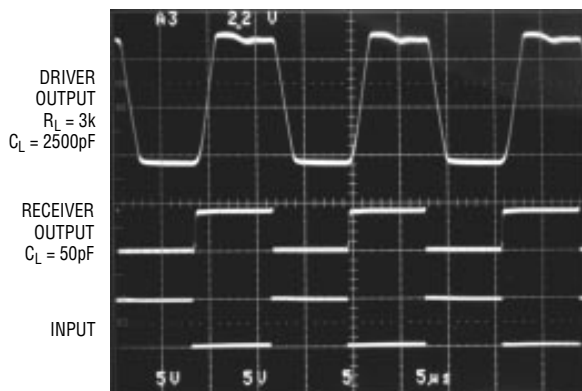

LT1280A • TA02

LT1280A/LT1281A

ABSOLUTE MAXIMUM RATINGS (Note 1)

Supply Voltage (V_{CC})	6V	Short-Circuit Duration	
V^+	13.2V	V^+	30 sec
V^-	-13.2V	V^-	30 sec
Input Voltage		Driver Output	Indefinite
Driver	V^- to V^+	Receiver Output	Indefinite
Receiver	-30V to 30V	Operating Temperature Range	
ON/OFF	-0.3V to 12V	LT1280AC/LT1281AC	0°C to 70°C
Output Voltage		LT1280AI/LT1281AI	-40°C to 85°C
Driver	$V^+ - 30V$ to $V^- + 30V$	Storage Temperature Range	-65°C to 150°C
Receiver	-0.3V to $V_{CC} + 0.3V$	Lead Temperature (Soldering, 10 sec)	300°C

PACKAGE/ORDER INFORMATION

<p>TOP VIEW</p> <p>N PACKAGE 18-LEAD PDIP SW PACKAGE 18-LEAD PLASTIC SO WIDE</p> <p>$T_{JMAX} = 125^{\circ}C$, $\theta_{JA} = 80^{\circ}C/W$, $\theta_{JC} = 36^{\circ}C/W$ (N) $T_{JMAX} = 125^{\circ}C$, $\theta_{JA} = 90^{\circ}C/W$, $\theta_{JC} = 26^{\circ}C/W$ (SW)</p>	<p>ORDER PART NUMBER</p> <p>LT1280ACN LT1280AIN LT1280ACSW LT1280AISW</p>	<p>TOP VIEW</p> <p>N PACKAGE 16-LEAD PDIP SW PACKAGE 16-LEAD PLASTIC SO WIDE</p> <p>$T_{JMAX} = 125^{\circ}C$, $\theta_{JA} = 90^{\circ}C/W$, $\theta_{JC} = 46^{\circ}C/W$ (N) $T_{JMAX} = 125^{\circ}C$, $\theta_{JA} = 95^{\circ}C/W$, $\theta_{JC} = 27^{\circ}C/W$ (SW)</p>	<p>ORDER PART NUMBER</p> <p>LT1281ACN LT1281AIN LT1281ACSW LT1281AISW</p>
--	---	--	---

Consult factory for Military grade parts.

ELECTRICAL CHARACTERISTICS (Note 2)

PARAMETER	CONDITIONS	MIN	TYP	MAX	UNITS
Power Supply Generator					
V^+ Output			7.9		V
V^- Output			-7.0		V
Supply Current (V_{CC})	(Note 3), $T_A = 25^{\circ}C$	●	8	10	mA
Supply Current When OFF (V_{CC})	Shutdown (Note 4) LT1280A Only	●	1	10	μA
Supply Rise Time	$C1 = C2 = C3 = C4 = 0.1\mu F$		0.2		ms
Shutdown to Turn-On	LT1280A Only		0.2		ms
ON/OFF Pin Thresholds	Input Low Level (Device Shutdown)	●	0.8	1.2	V
	Input High Level (Device Enabled)	●	1.6	2.4	V
ON/OFF Pin Current	$0V \leq V_{ON/OFF} \leq 5V$	●	-15	80	μA
Oscillator Frequency			130		kHz
Driver					
Output Voltage Swing	Load = 3k to GND	Positive	5.0	7.5	V
		Negative	-6.3	-5.0	V
Logic Input Voltage Level	Input Low Level ($V_{OUT} = High$)	●	1.4	0.8	V
	Input High Level ($V_{OUT} = Low$)	●	2.0	1.4	V

ELECTRICAL CHARACTERISTICS (Note 2)

PARAMETER	CONDITIONS	MIN	TYP	MAX	UNITS
Logic Input Current	$0.8V \leq V_{IN} \leq 2.0V$	●	5	20	μA
Output Short-Circuit Current	$V_{OUT} = 0V$	± 9	17		mA
Output Leakage Current	Shutdown $V_{OUT} = \pm 30V$ (Note 4)	●	10	100	μA
Data Rate (Note 7)	$R_L = 3k, C_L = 2500pF$ $R_L = 3k, C_L = 1000pF$	120 250			kBaud kBaud
Slew Rate	$R_L = 3k, C_L = 51pF$ $R_L = 3k, C_L = 2500pF$	4	15 7	30	V/ μs V/ μs
Propagation Delay	Output Transition t_{HL} High-to-Low (Note 5) Output Transition t_{LH} Low-to-High		0.6 0.5	1.3 1.3	μs μs

Receiver

Input Voltage Thresholds	Input Low Threshold ($V_{OUT} = \text{High}$)	C Grade	●	0.8	1.3		V
	Input High Threshold ($V_{OUT} = \text{Low}$)	C Grade	●		1.7	2.4	V
Hysteresis	Input Low	I Grade	●	0.2	1.3		V
	Input High	I Grade	●		1.7	3.0	V
Hysteresis			●	0.1	0.4	1.0	V
Input Resistance	$V_{IN} = \pm 10V$			3	5	7	k Ω
Output Leakage Current	Shutdown (Note 4) $0 \leq V_{OUT} \leq V_{CC}$	●		1	10		μA
Output Voltage	Output Low, $I_{OUT} = -1.6mA$	●			0.2	0.4	V
	Output High, $I_{OUT} = 160\mu A$ ($V_{CC} = 5V$)	●		3.5	4.2		V
Output Short-Circuit Current	Sinking Current, $V_{OUT} = V_{CC}$			10	-20	-10	mA
	Sourcing Current, $V_{OUT} = 0V$				20		mA
Propagation Delay	Output Transition t_{HL} High-to-Low (Note 6)				250	600	ns
	Output Transition t_{LH} Low-to-High				350	600	ns

The ● denotes specifications which apply over the operating temperature range ($0^\circ C \leq T_A \leq 70^\circ C$ for commercial grade, and $-40^\circ C \leq T_A \leq 85^\circ C$ for industrial grade).

Note 1: Absolute Maximum Ratings are those values beyond which the life of the device may be impaired.

Note 2: Testing done at $V_{CC} = 5V$ and $V_{ON/OFF} = 3V$, unless otherwise specified.

Note 3: Supply current is measured as the average over several charge pump cycles. $C^+ = C^- = C1 = C2 = 0.1\mu F$. All outputs are open, with all driver inputs tied high.

Note 4: Supply current measurements in shutdown are performed with $V_{ON/OFF} \leq 0.1V$.

Note 5: For driver delay measurements, $R_L = 3k$ and $C_L = 51pF$. Trigger points are set between the driver's input logic threshold and the output transition to the zero crossing ($t_{HL} = 1.4V$ to $0V$ and $t_{LH} = 1.4V$ to $0V$).

Note 6: For receiver delay measurements, $C_L = 51pF$. Trigger points are set between the receiver's input logic threshold and the output transition to standard TTL/CMOS logic threshold ($t_{HL} = 1.3V$ to $2.4V$ and $t_{LH} = 1.7V$ to $0.8V$).

Note 7: Data rate operation guaranteed by slew rate, short-circuit current and propagation delay tests.

TYPICAL PERFORMANCE CHARACTERISTICS

Driver Maximum Output Voltage vs Load Capacitance

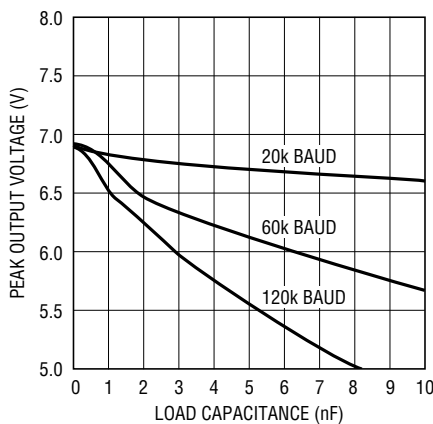

LT1280A • TPC01

Driver Minimum Output Voltage vs Load Capacitance

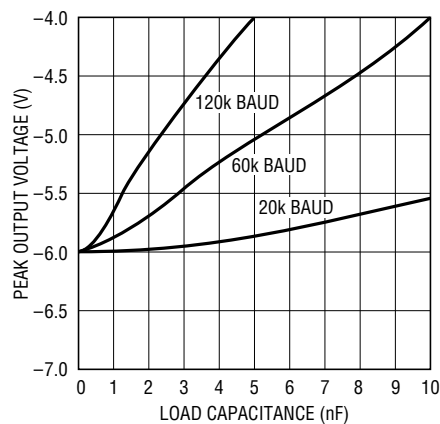

LT1280A • TPC02

Driver Output Voltage

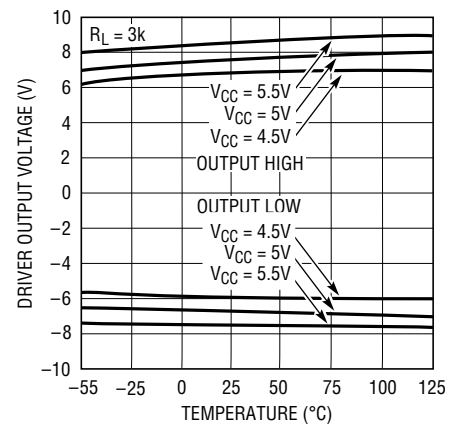

LT1280A • TPC03

TYPICAL PERFORMANCE CHARACTERISTICS

Receiver Input Thresholds

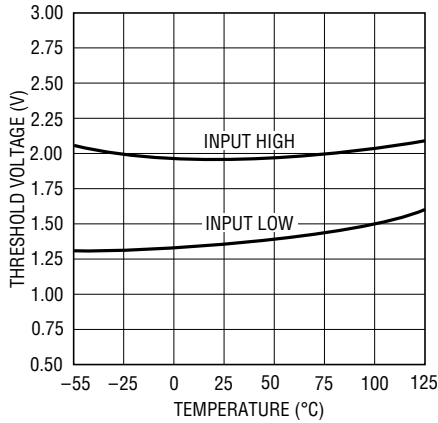

LT1280A • TPC04

Supply Current vs Data Rate

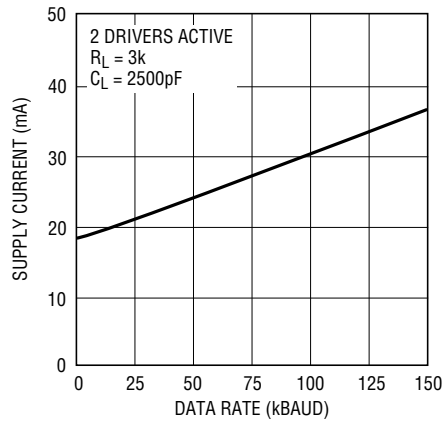

LT1280A • TPC05

ON/OFF Thresholds

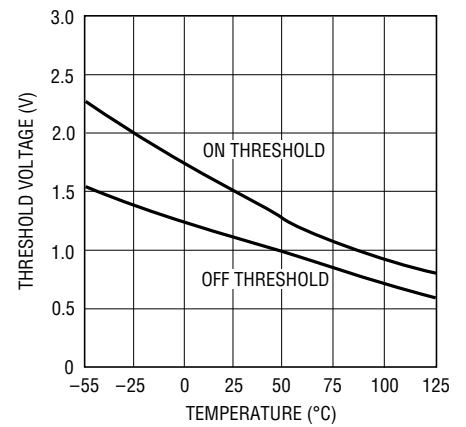

LT1280A • TPC06

Supply Current

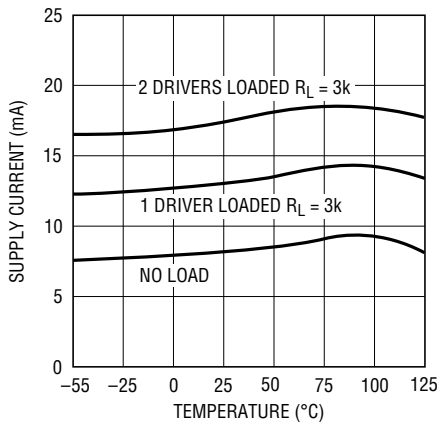

LT1280A • TPC07

Driver Leakage in Shutdown

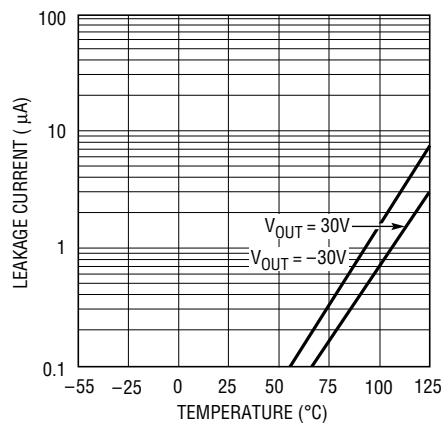

LT1280A • TPC08

Driver Short-Circuit Current

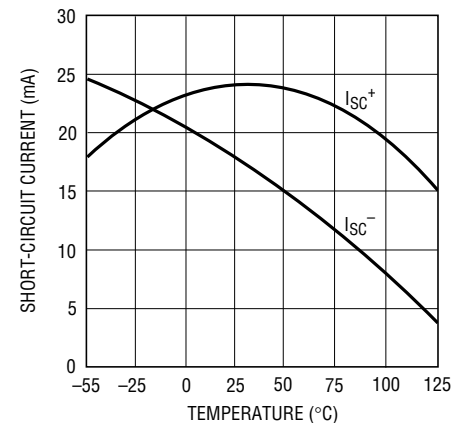

LT1280A • TPC09

Receiver Short-Circuit Current

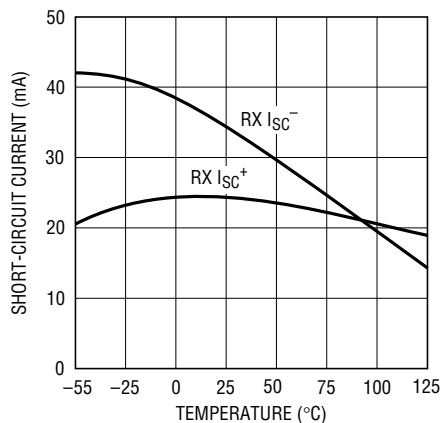

LT1280A • TPC10

Slew Rate vs Load Capacitance

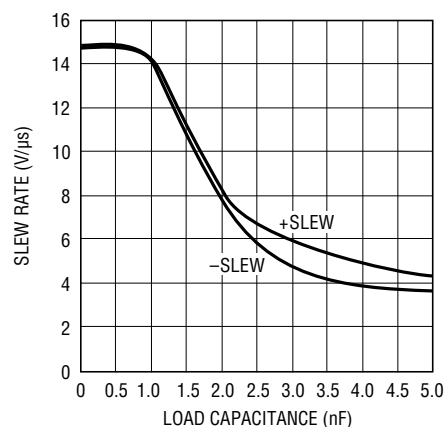

LT1280A • TPC11

TYPICAL PERFORMANCE CHARACTERISTICS

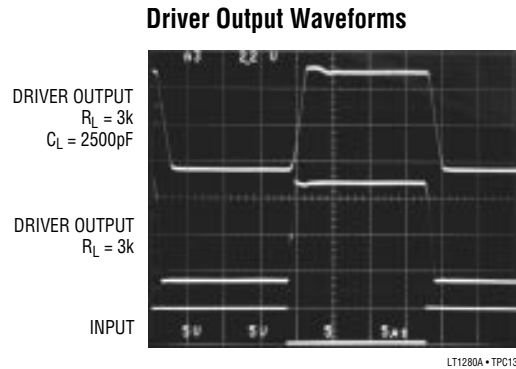
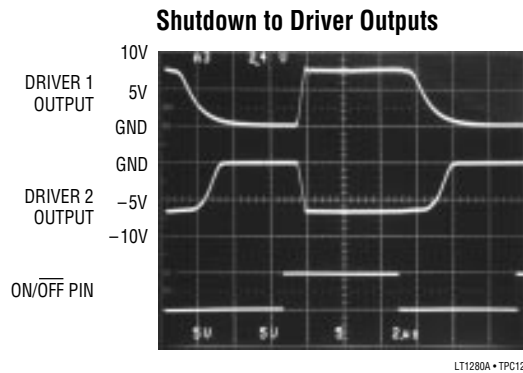

PIN FUNCTIONS

V_{CC}: 5V Input Supply Pin. This pin should be decoupled with a 0.1µF ceramic capacitor close to the package pin. Insufficient supply bypassing can result in low output drive levels and erratic charge pump operation.

GND: Ground Pin.

ON/OFF: A TTL/CMOS Compatible Operating Mode Control. A logic low puts the LT1280A in shutdown mode. Supply current drops to zero and both driver and receiver outputs assume a high impedance state. A logic high fully enables the device.

V⁺: Positive Supply Output (RS232 Drivers). $V^+ \approx 2V_{CC} - 1.5V$. This pin requires an external charge storage capacitor $C \geq 0.1\mu F$, tied to ground or V_{CC} . Larger value capacitors may be used to reduce supply ripple. With multiple transceivers, the V^+ and V^- pins may be paralleled into common capacitors.

V⁻: Negative Supply Output (RS232 Drivers). $V^- \approx -(2V_{CC} - 2.5V)$. This pin requires an external charge storage capacitor $C \geq 0.1\mu F$. Larger value capacitors may be used to reduce supply ripple. With multiple transceivers, the V^+ and V^- pins may be paralleled into common capacitors.

TR1 IN, TR2 IN: RS232 Driver Input Pins. These inputs are TTL/CMOS compatible. Inputs should not be allowed to float. Tie unused inputs to V_{CC} .

TR1 OUT, TR2 OUT: Driver Outputs at RS232 Voltage Levels. Driver output swing meets RS232 levels for loads up to 3k. Slew rates are controlled for lightly loaded lines.

Output current capability is sufficient for load conditions up to 2500pF. Outputs are in a high impedance state when in shutdown mode or $V_{CC} = 0V$. Outputs are fully short-circuit protected from $V^- + 30V$ to $V^+ - 30V$. Applying higher voltages will not damage the device if the overdrive is moderately current limited. Short circuits on one output can load the power supply generator and may disrupt the signal levels of the other outputs. The driver outputs are protected against ESD to $\pm 10kV$ for human body model discharges.

REC1 IN, REC2 IN: Receiver Inputs. These pins accept RS232 level signals ($\pm 30V$) into a protected 5k terminating resistor. The receiver inputs are protected against ESD to $\pm 10kV$ for human body model discharges. Each receiver provides 0.4V of hysteresis for noise immunity. Open receiver inputs assume a logic low state.

REC1 OUT, REC2 OUT: Receiver outputs with TTL/CMOS Voltage Levels. Outputs are in a high impedance state when in shutdown mode to allow data line sharing. Outputs are fully short-circuit protected to ground or V_{CC} with the power ON, OFF or in the shutdown mode.

C1⁺, C1⁻, C2⁺, C2⁻: Commutating Capacitor Inputs. These pins require two external capacitors $C \geq 0.1\mu F$: one from $C1^+$ to $C1^-$ and another from $C2^+$ to $C2^-$. $C1$ should be deleted if a separate 12V supply is available and connected to pin $C1^+$. Similarly, $C2$ should be deleted if a separate $-12V$ supply is connected to pin V^- .

PACKAGE DESCRIPTION Dimensions in inches (millimeters) unless otherwise noted.

N Package
16-Lead PDIP (Narrow 0.300)
 (LTC DWG # 05-08-1510)

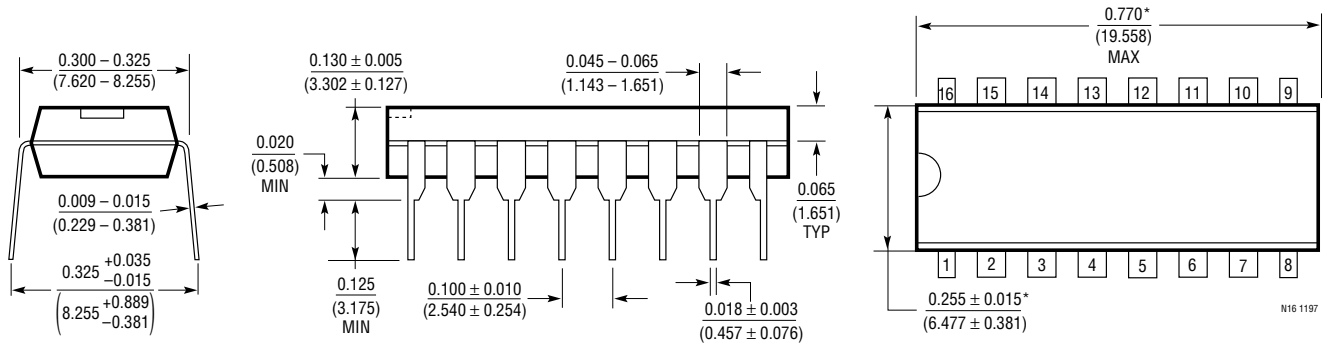

*THESE DIMENSIONS DO NOT INCLUDE MOLD FLASH OR PROTRUSIONS.
 MOLD FLASH OR PROTRUSIONS SHALL NOT EXCEED 0.010 INCH (0.254mm)

N Package
18-Lead PDIP (Narrow 0.300)
 (LTC DWG # 05-08-1510)

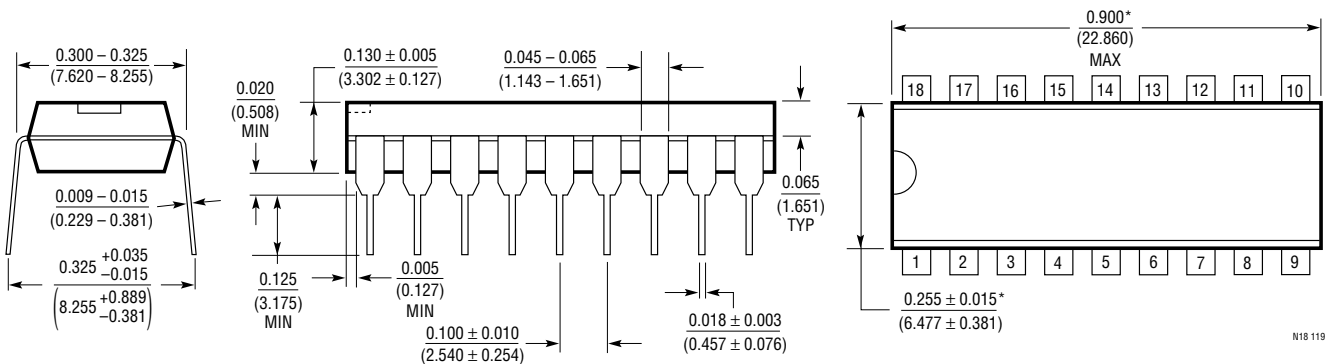

*THESE DIMENSIONS DO NOT INCLUDE MOLD FLASH OR PROTRUSIONS.
 MOLD FLASH OR PROTRUSIONS SHALL NOT EXCEED 0.010 INCH (0.254mm)

SW Package
16-Lead Plastic Small Outline (Wide 0.300)
 (LTC DWG # 05-08-1620)

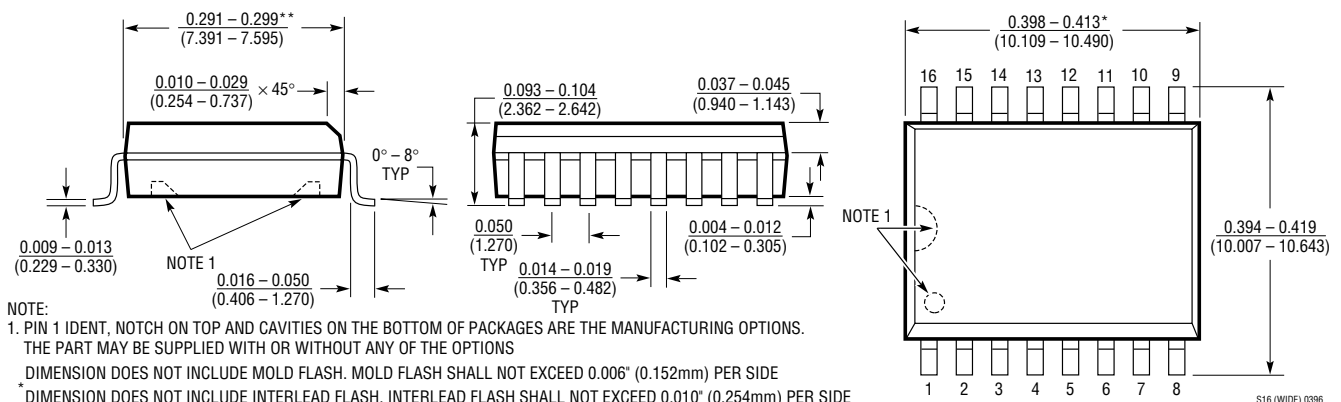

NOTE:
 1. PIN 1 IDENT, NOTCH ON TOP AND CAVITIES ON THE BOTTOM OF PACKAGES ARE THE MANUFACTURING OPTIONS.
 THE PART MAY BE SUPPLIED WITH OR WITHOUT ANY OF THE OPTIONS
 * DIMENSION DOES NOT INCLUDE MOLD FLASH. MOLD FLASH SHALL NOT EXCEED 0.006" (0.152mm) PER SIDE
 ** DIMENSION DOES NOT INCLUDE INTERLEAD FLASH. INTERLEAD FLASH SHALL NOT EXCEED 0.010" (0.254mm) PER SIDE