

FEATURES

- One Receiver Remains Active While in Shutdown
- ESD Protection Over $\pm 10\text{kV}$
- Uses Small Capacitors: $0.1\mu\text{F}$, $0.2\mu\text{F}$
- $60\mu\text{A}$ Supply Current in Shutdown
- Pin Compatible with LT1137A
- 120kBaud Operation for $R_L = 3\text{k}$, $C_L = 2500\text{pF}$
- 250kBaud Operation for $R_L = 3\text{k}$, $C_L = 1000\text{pF}$
- CMOS Comparable Low Power: 60mW
- Operates from a Single 5V Supply
- Easy PC Layout: Flowthrough Architecture
- Rugged Bipolar Design
- Outputs Assume a High Impedance State When Off or Powered Down
- Absolutely No Latchup
- Available in SSOP Package

APPLICATIONS

- Notebook Computers
- Palmtop Computers

DESCRIPTION

The LT[®]1341 is an advanced low power three-driver, five-receiver RS232 transceiver. Included on the chip is a shutdown pin for reducing supply current to near zero. During shutdown one receiver remains active to detect incoming RS232 signals, for example, to wake up a system. All other receivers and the drivers assume high impedance states during shutdown.

The driver disable function provides additional control of operating mode. When driver disable is high the charge pump and drivers turn off. Receivers continue to operate during driver disable.

New ESD structures on the chip allow the LT1341 to survive multiple $\pm 10\text{kV}$ strikes, eliminating the need for costly TransZorbs[®] on the RS232 line pins.

The LT1341 is fully compliant with all EIA RS232 specifications and operates in excess of 120kbaud even driving heavy capacitive loads.

LT, LTC and LT are registered trademarks of Linear Technology Corporation. TransZorb is a registered trademark of General Instruments, GSI

TYPICAL APPLICATION

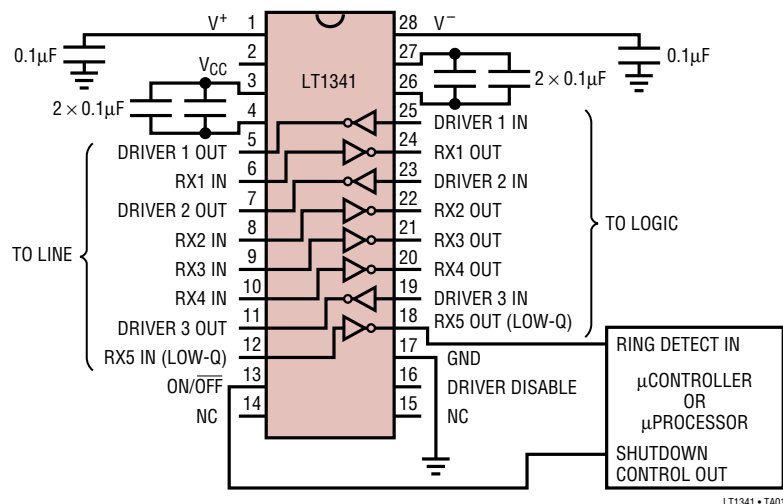

Output Waveforms

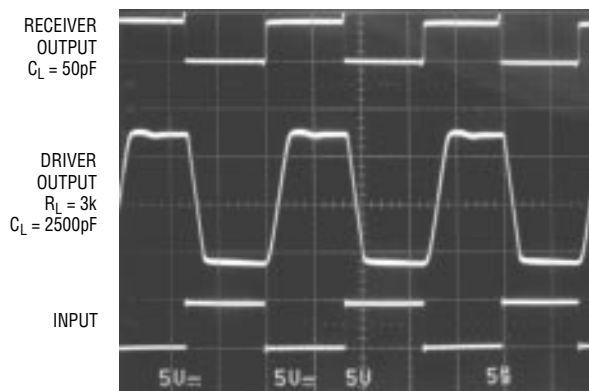

LT1341 • TA02

ABSOLUTE MAXIMUM RATINGS

(Note 1)

Supply Voltage (V_{CC})	6V
V^+	13.2V
V^-	-13.2V
Input Voltage	
Driver	V^+ to V^-
Receiver	30V to -30V
Output Voltage	
Driver	-30V to 30V
Receiver	-0.3V to $V_{CC} + 0.3V$
Short Circuit Duration	
V^+	30 sec
V^-	30 sec
Driver Output	Indefinite
Receiver Output	Indefinite
Operating Temperature Range	
LT1341C	0°C to 70°C
Storage Temperature Range	-65°C to 150°C
Lead Temperature (Soldering, 10 sec)	300°C

PACKAGE/ORDER INFORMATION

<p>TOP VIEW</p> <p>G PACKAGE 28-LEAD PLASTIC SSOP</p> <p>NW PACKAGE 28-LEAD (WIDE) PDIP</p> <p>SW PACKAGE 28-LEAD (WIDE) PLASTIC SO</p> <p>$T_{JMAX} = 125^{\circ}C, \theta_{JA} = 96^{\circ}C/W$ (G) $T_{JMAX} = 125^{\circ}C, \theta_{JA} = 56^{\circ}C/W$ (NW) $T_{JMAX} = 125^{\circ}C, \theta_{JA} = 85^{\circ}C/W$ (SW)</p>	ORDER PART NUMBER
	<p>LT1341CG LT1341CNW LT1341CSW</p>

Consult factory for Industrial and Military grade parts.

ELECTRICAL CHARACTERISTICS (Note 2)

PARAMETER	CONDITIONS	MIN	TYP	MAX	UNITS
Power Supply Generator					
V^+ Output			8.6		V
V^- Output			-7		V
Supply Current (V_{CC})	(Note 3)		14	17	mA
Supply Current When OFF (V_{CC})	Shutdown (Note 4) Driver Disable	●	0.06 3	0.150	mA mA
Supply Rise Time Shutdown to Turn-On	$C1 = C2 = 0.2\mu F$, $C^+ = C^- = 0.1\mu F$		0.2		ms
ON/OFF Pin Thresholds	Input Low Level (Device Shut Down) Input High Level (Device Enabled)	● ●	1.4 1.4	0.8	V V
ON/OFF Pin Current	$0V \leq V_{ON/OFF} \leq 5V$	●	-15	80	μA
DRIVER DISABLE Pin Thresholds	Input Low Level (Drivers Enabled) Input High Level (Drivers Disabled)	● ●	1.4 1.4	0.8	V V
DRIVER DISABLE Pin Current	$0V \leq V_{DRIVER\ DISABLE} \leq 5V$	●	-10	500	μA
Oscillator Frequency			130		kHz

ELECTRICAL CHARACTERISTICS (Note 2)

PARAMETER	CONDITIONS	MIN	TYP	MAX	UNITS	
Any Driver						
Output Voltage Swing	Load = 3k to GND Positive Negative	● ●	5 7.3 -6.5	-5	V V	
Logic Input Voltage Level	Input Low Level ($V_{OUT} = \text{High}$) Input High Level ($V_{OUT} = \text{Low}$)	● ●	1.4 1.4	0.8	V V	
Logic Input Current	$0.8V \leq V_{IN} \leq 2V$	●	5	20	μA	
Output Short-Circuit Current	$V_{OUT} = 0V$		± 9	± 17	mA	
Output Leakage Current	Shutdown $V_{OUT} = \pm 30V$ (Note 4)	●	10	100	μA	
Data Rate (Note 7)	$R_L = 3k, C_L = 2500\text{pF}$ $R_L = 3k, C_L = 1000\text{pF}$		120 250		kBaud kBaud	
Slew Rate	$R_L = 3k, C_L = 51\text{pF}$ $R_L = 3k, C_L = 2500\text{pF}$		15 6	30	$\text{V}/\mu\text{s}$ $\text{V}/\mu\text{s}$	
Propagation Delay	Output Transition t_{HL} High to Low (Note 5) Output Transition t_{LH} Low to High		0.6 0.5	1.3 1.3	μs μs	
Any Receiver						
Input Voltage Thresholds	Input Low Threshold ($V_{OUT} = \text{High}$) Input High Threshold ($V_{OUT} = \text{Low}$)		0.8 1.7	1.3 2.4	V V	
Hysteresis		●	0.1	0.4	1.0	V
Input Resistance			3	5	7	$\text{k}\Omega$
Output Leakage Current	Shutdown (Note 4) $0 \leq V_{OUT} \leq V_{CC}$	●	1	10	μA	
Receivers 1 Through 4						
Output Voltage	Output Low, $I_{OUT} = -1.6\text{mA}$ Output High, $I_{OUT} = 160\mu\text{A}$ ($V_{CC} = 5V$)	● ●	0.2 3.5	0.4	V V	
Output Short-Circuit Current	Sinking Current, $V_{OUT} = V_{CC}$ Sourcing Current, $V_{OUT} = 0V$		10	-20 20	mA mA	
Propagation Delay	Output Transition t_{HL} High to Low (Note 6) Output Transition t_{LH} Low to High		250 350	600 600	ns ns	
Receiver 5 (Low-I_Q RX)						
Output Voltage	Output Low, $I_{OUT} = -500\mu\text{A}$ Output High, $I_{OUT} = 160\mu\text{A}$ ($V_{CC} = 5V$)	● ●	0.2 3.5	0.4	V V	
Output Short-Circuit Current	Sinking Current, $V_{OUT} = V_{CC}$ Sourcing Current, $V_{OUT} = 0V$		2	-4 4	mA mA	
Propagation Delay	Output Transition t_{HL} High to Low (Note 6) Output Transition t_{LH} Low to High		1 1	3 3	μs μs	

The ● denotes specifications which apply over the full operating temperature range ($0^\circ\text{C} \leq T_A \leq 70^\circ\text{C}$ for commercial grade).

Note 1: Absolute Maximum Ratings are those values beyond which the life of the device may be impaired.

Note 2: Testing done at $V_{CC} = 5V$ and $V_{ON/OFF} = 3V$.

Note 3: Supply current is measured as the average over several charge pump cycles. $C^+ = C^- = 0.1\mu\text{F}$, $C1 = C2 = 0.2\mu\text{F}$. All outputs are open with all driver inputs tied high.

Note 4: Supply current and leakage measurements in shutdown are performed with $V_{ON/OFF} \leq 0.1V$. Supply current measurements using driver disable are performed with $V_{DRIVER\ DISABLE} \geq 3V$.

Note 5: For driver delay measurements, $R_L = 3k$ and $C_L = 51\text{pF}$. Trigger points are set between the driver's input logic threshold and the output transition to the zero crossing ($t_{HL} = 1.4V$ to $0V$ and $t_{LH} = 1.4V$ to $0V$).

Note 6: For receiver delay measurements, $C_L = 51\text{pF}$. Trigger points are set between the receiver's input logic threshold and the output transition to standard TTL/CMOS logic threshold ($t_{HL} = 1.3V$ to $2.4V$ and $t_{LH} = 1.7V$ to $0.8V$).

Note 7: Data rate operation guaranteed by slew rate, short-circuit current and propagation delay tests.

TYPICAL PERFORMANCE CHARACTERISTICS

Driver Output Voltage

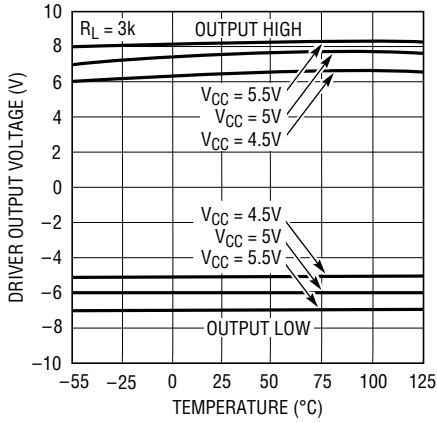

LT1341 • TPC01

Receiver Input Thresholds

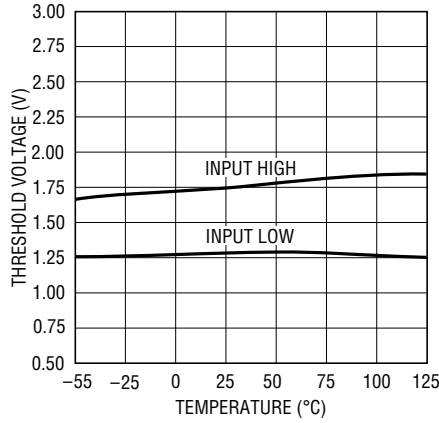

LT1341 • TPC02

Supply Current vs Data Rate

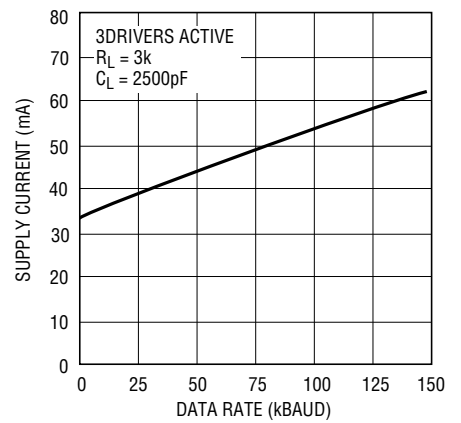

LT1341 • TPC03

Supply Current in Shutdown

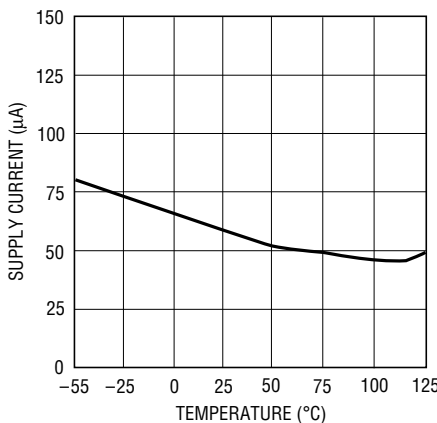

LT1341 • TPC04

Supply Current in Driver Disable

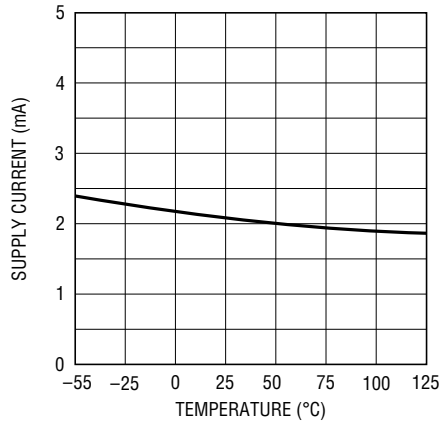

LT1341 • TPC05

DRIVER DISABLE Threshold

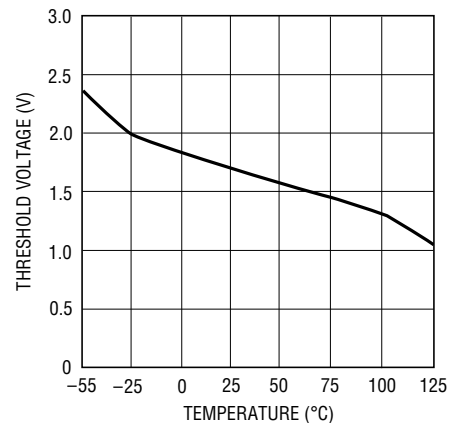

LT1341 • TPC06

ON/OFF Thresholds

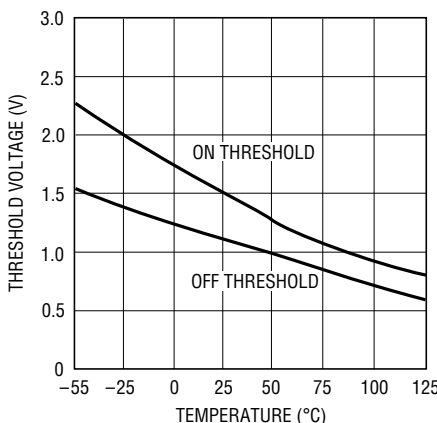

LT1341 • TPC07

Supply Current

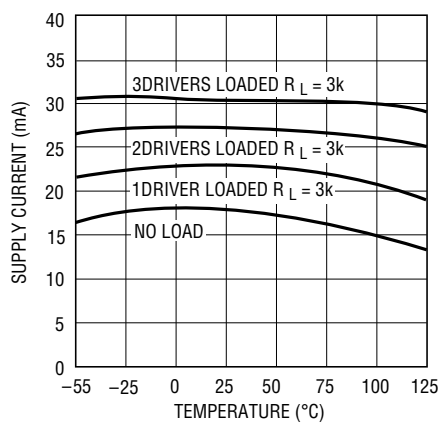

LT1341 • TPC08

Driver Leakage in Shutdown

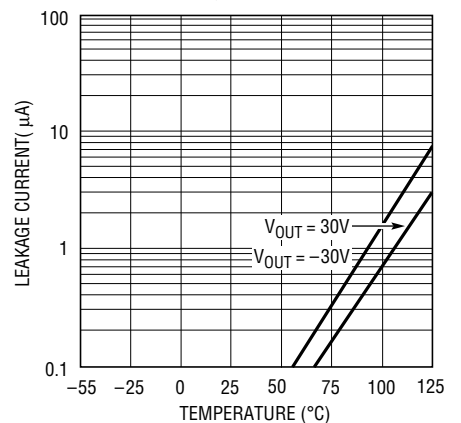

LT1341 • TPC09

TYPICAL PERFORMANCE CHARACTERISTICS

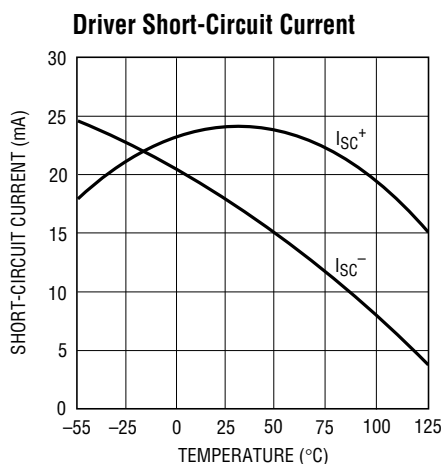

LT1341 • TPC10

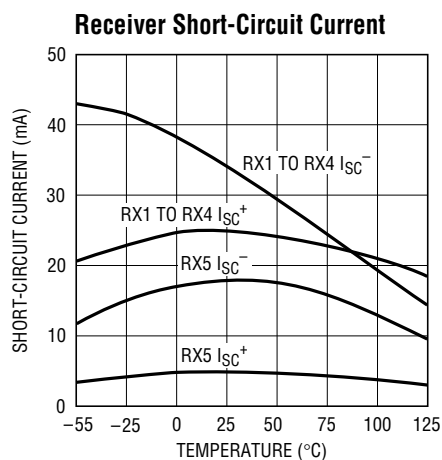

LT1341 • TPC11

Receiver Output Waveforms

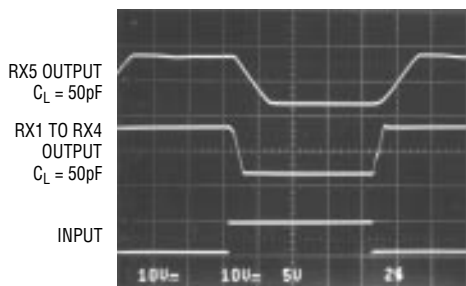

LT1341 • TPC12

Driver Output Waveforms

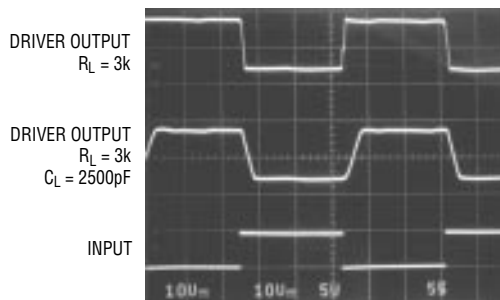

LT1341 • TPC13

PIN FUNCTIONS

V_{CC}: 5V Input Supply Pin. This pin should be decoupled with a 0.1μF ceramic capacitor close to the package pin. Insufficient supply bypassing can lead to low output drive levels and erratic charge pump operation.

GND: Ground Pin.

ON/OFF: A TTL/CMOS logic low puts the device in the low power shutdown mode. All of the drivers and four receivers go to a high impedance state. Receiver RX5 remains active while the transceiver is in shutdown. The transceiver consumes only 60μA of supply current while in shutdown. A logic high fully enables the transceiver.

DRIVER DISABLE: This pin provides an alternate control for the charge pump and RS232 drivers. A logic high on this pin shuts down the charge pump and places all drivers

in a high impedance state. All receivers remain active under these conditions. Floating the driver disable pin or driving it to a logic low level fully enables the transceiver. Supply current drops to 3mA when in driver disable mode. A logic low on the ON/OFF pin supersedes the state of the DRIVER DISABLE pin.

V⁺: Positive Supply Output (RS232 Drivers). $V^+ \approx 2V_{CC} - 1.5V$. This pin requires an external charge storage capacitor $C \geq 0.1\mu F$, tied to ground or V_{CC} . Larger value capacitors may be used to reduce supply ripple. With multiple transceivers, the V^+ and V^- pins may be paralleled into common capacitors. For large numbers of transceivers, increasing the size of the storage capacitors is recommended to reduce ripple.

PIN FUNCTIONS

V⁻: Negative Supply Output (RS232 Drivers). $V^- \approx -(2V_{CC} - 2.5V)$. This pin requires an external charge storage capacitor $C \geq 0.1\mu F$. To reduce supply ripple, increase the size of the storage capacitor. With multiple transceivers, the V^+ and V^- pins may be paralleled into common filter capacitors.

C1⁺, C1⁻, C2⁺, C2⁻: Commutating Capacitor Inputs. These pins require two external capacitors $C \geq 0.2\mu F$: one from $C1^+$ to $C1^-$, and another from $C2^+$ to $C2^-$. The capacitor's effective series resistance should be less than 2Ω . For $C \geq 1\mu F$, low ESR tantalum capacitors work well in this application, although small value ceramic capacitors may be used with a minimal reduction in charge pump compliance. When a 12V supply is available, $C1$ may be omitted. Connect the 12V supply to $C1^+$ and V^+ . The 12V supply should be decoupled with a $0.1\mu F$ ceramic capacitor.

DRIVER IN: RS232 Driver Input Pins. These inputs are TTL/CMOS compatible. Tie unused inputs to V_{CC} .

DRIVER OUT: Driver Outputs at RS232 Voltage Levels. Outputs are in a high impedance state when in shutdown mode, $V_{CC} = 0V$, or when the DRIVER DISABLE pin is active. Outputs are fully short-circuit protected from $V_{OUT} = V^- + 30V$ to $V_{OUT} = V^+ - 30V$. Applying higher voltages will not damage the device if the over-

drive is moderately current limited. Short circuits on one output can load the power supply generator and may disrupt the signal levels of the other outputs. The driver outputs are protected against ESD to $\pm 10kV$ for human body model discharges.

RX IN: Receiver Inputs. These pins accept RS232 level signals ($\pm 30V$) into a protected 5k terminating resistor. The receiver inputs are protected against ESD to $\pm 10kV$ for human body model discharges. Each receiver provides 0.4V of hysteresis for noise immunity.

RX OUT: Receiver Outputs with TTL/CMOS Voltage Levels. Outputs are in a high impedance state when in shutdown mode to allow data line sharing. Outputs, including LOW-Q RX OUT, are fully short-circuit protected to ground or V_{CC} with the power on, off, or in shutdown mode.

LOW Q-CURRENT RX IN: Low Power Receiver Input. This special receiver remains active when the part is in shutdown mode, consuming typically $60\mu A$. This receiver has the same input and protection characteristics as the other receivers.

LOW Q-CURRENT RX OUT: Low Power Receiver Output. This pin produces the same TTL/CMOS output voltage levels with slightly decreased speed and short-circuit current.

ESD PROTECTION

The RS232 line inputs of the LT1341 have on-chip protection from ESD transients up to $\pm 10kV$. The protection structures act to divert the static discharge safely to system ground. In order for the ESD protection to function effectively, the power supply and ground pins of the LT1341 must be connected to ground through low impedances. The power supply decoupling capacitors and charge pump storage capacitors provide this low impedance in normal application of the circuit. The only constraint is that low ESR capacitors must be used for bypassing and charge storage. ESD testing must be done with pins V_{CC} , V^+ , V^- and GND shorted to ground or connected with low ESR capacitors.

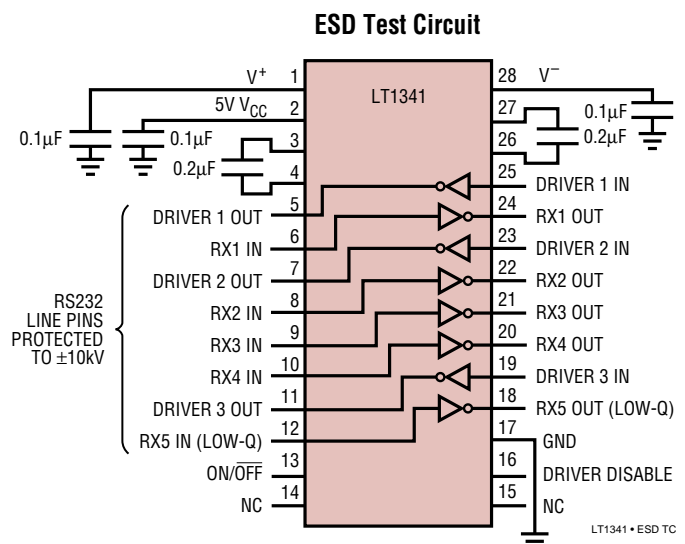

PACKAGE DESCRIPTION Dimensions in inches (millimeters) unless otherwise noted.

G Package
28-Lead Plastic SSOP (0.209)
 (LTC DWG # 05-08-1640)

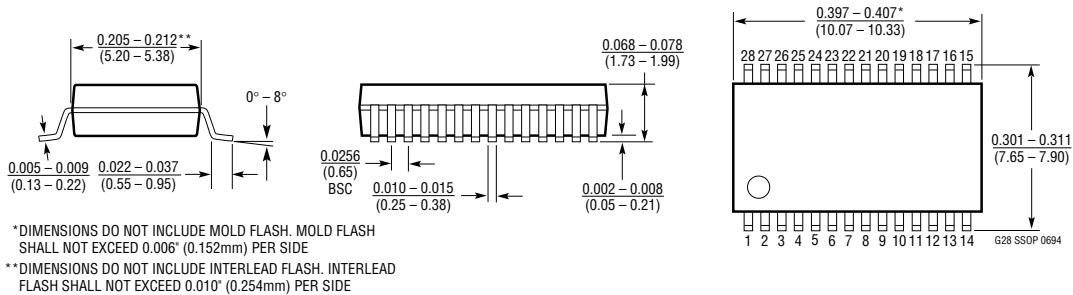

NW Package
28-Lead PDIP (Wide 0.600)
 (LTC DWG # 05-08-1520)

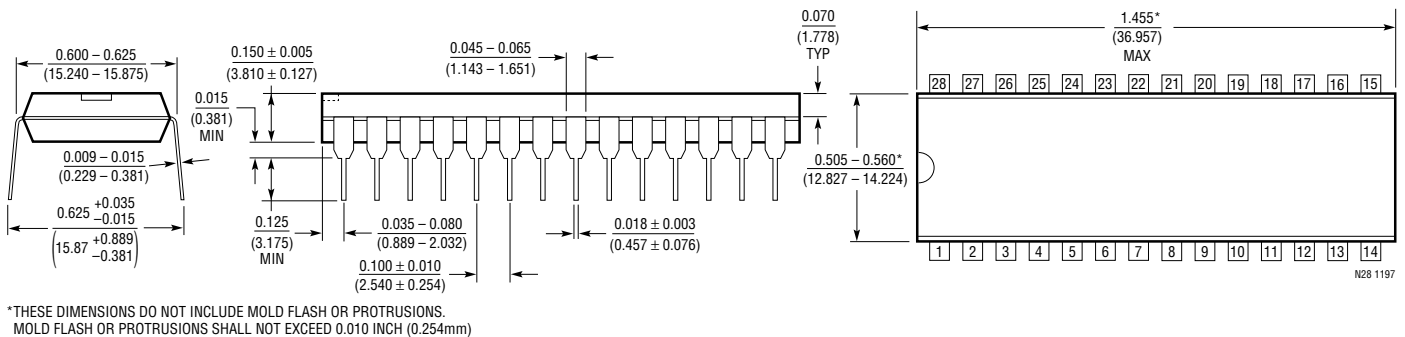

SW Package
28-Lead Plastic Small Outline (Wide 0.300)
 (LTC DWG # 05-08-1620)

