

FEATURES

- ESD Protection Over $\pm 10\text{kV}$
- 3V Logic Interface
- Uses Small Capacitors: $0.1\mu\text{F}$, $0.2\mu\text{F}$
- $1\mu\text{A}$ Supply Current in Shutdown
- Low Power Driver Disable Operating Mode
- Pin Compatible with LT1137A
- **120kbaud Operation for $R_L = 3\text{k}$, $C_L = 2500\text{pF}$**
- **250kbaud Operation for $R_L = 3\text{k}$, $C_L = 1000\text{pF}$**
- CMOS Comparable Low Power: 60mW
- Operates from a 5V Supply and 3V Logic Supply
- Easy PC Layout: Flowthrough Architecture
- Rugged Bipolar Design
- Outputs Assume a High Impedance State When Off or Powered Down
- Absolutely No Latchup

APPLICATIONS

- Notebook Computers
- Palmtop Computers

DESCRIPTION

The LT[®]1342 is an advanced low power three-driver, five-receiver RS232 transceiver. The LT1342 operates from a 5V supply and a 3V logic supply. Receiver outputs can interface directly to 3V logic circuits. Included on the chip is a shutdown pin for reducing supply current to near zero. All receivers and drivers assume high impedance states during shutdown.

The driver disable function provides additional control of operating mode. When driver disable is high the charge pump and drivers turn off. Receivers continue to operate during driver disable.

New ESD structures on the chip allow the LT1342 to survive multiple $\pm 10\text{kV}$ strikes, eliminating the need for costly TransZorbs[®] on the RS232 line pins.

The LT1342 is fully compliant with all EIA RS232 specifications and operates in excess of 120kbaud even driving heavy capacitive loads.

LT, LTC and LT are registered trademarks of Linear Technology Corporation. TransZorb is a registered trademark of General Instruments, GSI.

TYPICAL APPLICATION

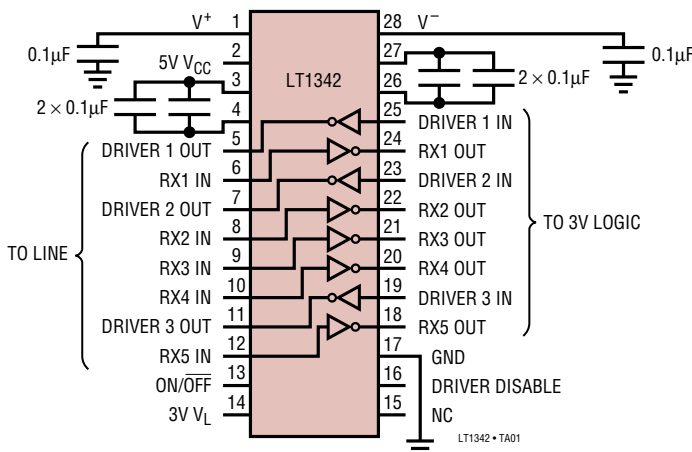

Output Waveforms

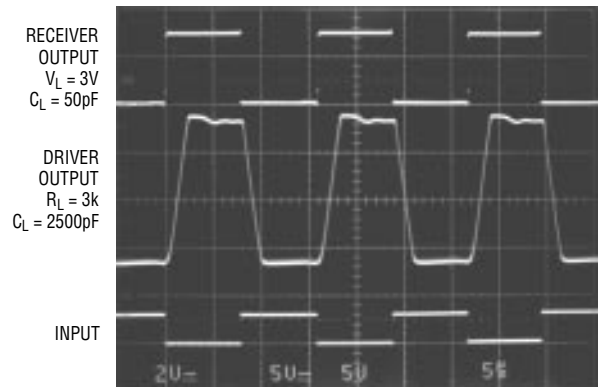

LT1342 • TA02

ABSOLUTE MAXIMUM RATINGS

(Note 1)

Supply Voltage (V_{CC})	6V
Supply Voltage (V_L)	6V
V^+	13.2V
V^-	-13.2V
Input Voltage	
Driver	V^- to V^+
Receiver	-30V to 30V
Output Voltage	
Driver	-30V to 30V
Receiver	-0.3V to $V_{CC} + 0.3V$
Short-Circuit Duration	
V^+	30 sec
V^-	30 sec
Driver Output	Indefinite
Receiver Output	Indefinite
Operating Temperature Range	0°C to 70°C
Storage Temperature Range	-65°C to 150°C
Lead Temperature (Soldering, 10 sec)	300°C

PACKAGE/ORDER INFORMATION

<p>TOP VIEW</p> <p> V^+ 1, 5V V_{CC} 2, $C1^+$ 3, $C1^-$ 4, DRIVER 1 OUT 5, RX1 IN 6, DRIVER 2 OUT 7, RX2 IN 8, RX3 IN 9, RX4 IN 10, DRIVER 3 OUT 11, RX5 IN 12, ON/OFF 13, 3V V_L 14, 28 V^-, 27 $C2^-$, 26 $C2^+$, 25 DRIVER 1 IN, 24 RX1 OUT, 23 DRIVER 2 IN, 22 RX2 OUT, 21 RX3 OUT, 20 RX4 OUT, 19 DRIVER 3 IN, 18 RX5 OUT, 17 GND, 16 DRIVER DISABLE, 15 NC. </p> <p> G PACKAGE: 28-LEAD PLASTIC SSOP NW PACKAGE: 28-LEAD WIDE PDIP SW PACKAGE: 28-LEAD WIDE PLASTIC SO </p> <p> $T_{JMAX} = 125^\circ\text{C}, \theta_{JA} = 96^\circ\text{C/W (G)}$ $T_{JMAX} = 125^\circ\text{C}, \theta_{JA} = 56^\circ\text{C/W (NW)}$ $T_{JMAX} = 125^\circ\text{C}, \theta_{JA} = 85^\circ\text{C/W (SW)}$ </p>	ORDER PART NUMBER
	LT1342CG LT1342CNW LT1342CSW

Consult factory for Industrial and Military grade parts.

ELECTRICAL CHARACTERISTICS (Note 2)

PARAMETER	CONDITIONS	MIN	TYP	MAX	UNITS
Power Supply Generator					
V^+ Output			8.6		V
V^- Output			-7		V
Supply Current (V_{CC})	(Note 3)		12	17	mA
Logic Supply Current (V_L)	(Note 4)		0.1	1	mA
Supply Current When OFF (V_{CC})	Shutdown (Note 5) Driver Disable	●	1	10	μA
			3		mA
Logic Supply Current (V_L) When OFF	Shutdown (Note 5) Driver Disable	●	1	10	μA
			0.1	1	mA
Supply Rise Time Shutdown to Turn-On	$C1 = C2 = 0.2\mu\text{F}$, $C^+ = C^- = 0.1\mu\text{F}$		0.2		ms
ON/OFF Pin Thresholds	Input Low Level (Device Shutdown) Input High Level (Device Enabled)	●	1.4	0.8	V
		●	2.4	1.4	V
ON/OFF Pin Current	$0V \leq V_{ON/OFF} \leq 5V$	●	-15	80	μA
DRIVER DISABLE Pin Thresholds	Input Low Level (Drivers Enabled) Input High Level (Drivers Disabled)	●	1.4	0.8	V
		●	2.4	1.4	V
DRIVER DISABLE Pin Current	$0V \leq V_{DRIVER\ DISABLE} \leq 5V$	●	-10	500	μA
Oscillator Frequency			130		kHz

ELECTRICAL CHARACTERISTICS (Note 2)

PARAMETER	CONDITIONS		MIN	TYP	MAX	UNITS
Any Driver						
Output Voltage Swing	Load = 3k to GND	Positive	●	5	7.3	V
		Negative	●		-6.5	-5
Logic Input Voltage Level	Input Low Level ($V_{OUT} = \text{High}$)		●		1.4	0.8
	Input High Level ($V_{OUT} = \text{Low}$)		●	2	1.4	V
Logic Input Current	$0.8V \leq V_{IN} \leq 2V$		●		5	20
Output Short-Circuit Current	$V_{OUT} = 0V$			±9	17	mA
Output Leakage Current	Shutdown, $V_{OUT} = \pm 30V$ (Note 5)		●		10	100
Data Rate (Note 8)	$R_L = 3k, C_L = 2500pF$			120		kBaud
	$R_L = 3k, C_L = 1000pF$			250		kBaud
Slew Rate	$R_L = 3k, C_L = 51pF$				15	30
	$R_L = 3k, C_L = 2500pF$			4	6	V/μs
Propagation Delay	Output Transition t_{HL} High to Low (Note 6)				0.6	1.3
	Output Transition t_{LH} Low to High				0.5	1.3
Any Receiver						
Input Voltage Thresholds	Input Low Threshold ($V_{OUT} = \text{High}$)			0.8	1.3	V
	Input High Threshold ($V_{OUT} = \text{Low}$)				1.7	2.4
Hysteresis		●		0.1	0.4	1
Input Resistance				3	5	7
Output Leakage Current	Shutdown (Note 4) $0 \leq V_{OUT} \leq V_{CC}$	●			1	10
Receivers 1 Through 4						
Output Voltage	Output Low, $I_{OUT} = -1.6mA$	●		0.2	0.4	V
	Output High, $I_{OUT} = 160\mu A$	●		2.7	2.9	V
Output Short-Circuit Current	Sinking Current, $V_{OUT} = V_{CC}$				-20	-10
	Sourcing Current, $V_{OUT} = 0V$			10	20	mA
Propagation Delay	Output Transition t_{HL} High to Low (Note 7)				250	600
	Output Transition t_{LH} Low to High				350	600
Receiver 5						
Output Voltage	Output Low, $I_{OUT} = -500\mu A$	●		0.2	0.4	V
	Output High, $I_{OUT} = 160\mu A$	●		2.7	2.9	V
Output Short-Circuit Current	Sinking Current, $V_{OUT} = V_{CC}$				-4	-2
	Sourcing Current, $V_{OUT} = 0V$			2	4	mA
Propagation Delay	Output Transition t_{HL} High to Low (Note 7)				1	3
	Output Transition t_{LH} Low to High				1	3

The ● denotes specifications which apply over the full operating temperature range ($0^\circ C \leq T_A \leq 70^\circ C$ for commercial grade).

Note 1: Absolute Maximum Ratings are those values beyond which the life of the device may be impaired.

Note 2: Testing done at $V_{CC} = 5V, V_L = 3.3V$ and $V_{ON/OFF} = 3V$.

Note 3: Supply current is measured with external capacitors $C^+ = C^- = 0.1\mu F, C1 = C2 = 0.2\mu F$. All outputs are open with all driver inputs tied high.

Note 4: V_L supply current is measured with all receiver outputs high.

Note 5: Supply current and leakage measurements in shutdown are performed with $V_{ON/OFF} \leq 0.1V$. Supply current measurements using driver disable are performed with $V_{DRIVER\ DISABLE} \geq 3V$.

Note 6: For driver delay measurements, $R_L = 3k$ and $C_L = 51pF$. Trigger points are set between the driver's input logic threshold and the output transition to the zero crossing ($t_{HL} = 1.4V$ to $0V$ and $t_{LH} = 1.4V$ to $0V$).

Note 7: For receiver delay measurements, $C_L = 51pF$. Trigger points are set between the receiver's input logic threshold and the output transition to standard TTL/CMOS logic threshold ($t_{HL} = 1.3V$ to $2.4V$ and $t_{LH} = 1.7V$ to $0.8V$).

Note 8: Data rate operation guaranteed by slew rate, short-circuit current and propagation delay tests.

TYPICAL PERFORMANCE CHARACTERISTICS

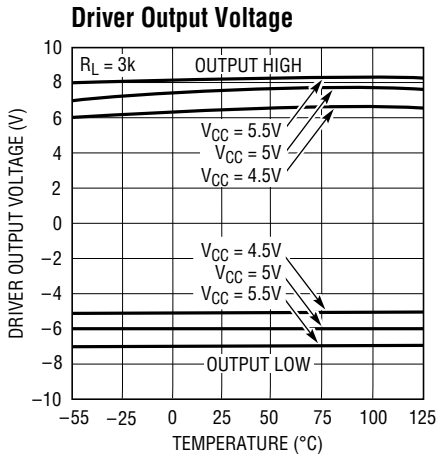

LT1342 • TPC01

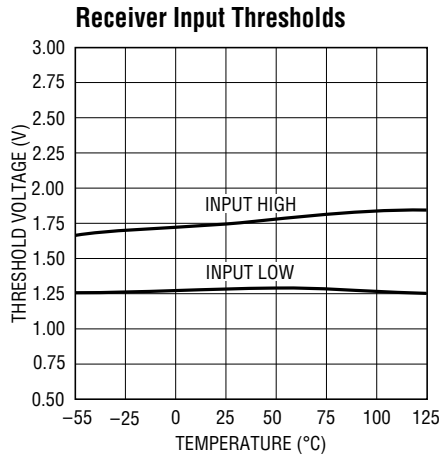

LT1342 • TPC02

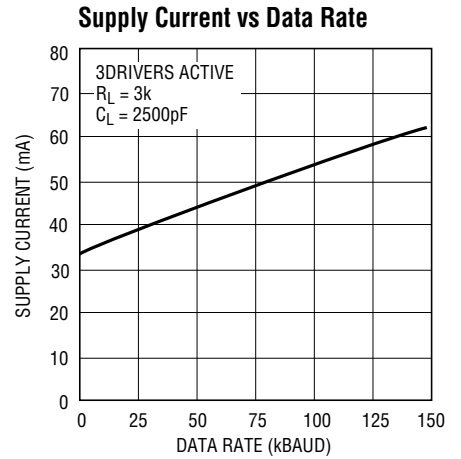

LT1342 • TPC03

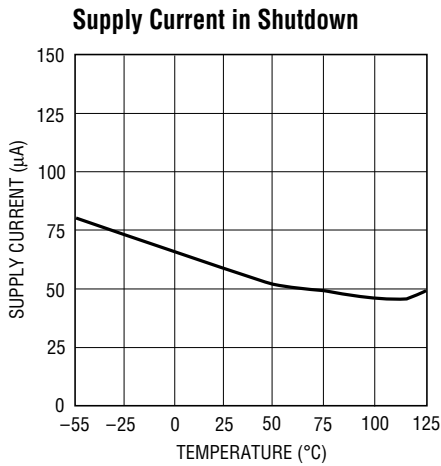

LT1342 • TPC04

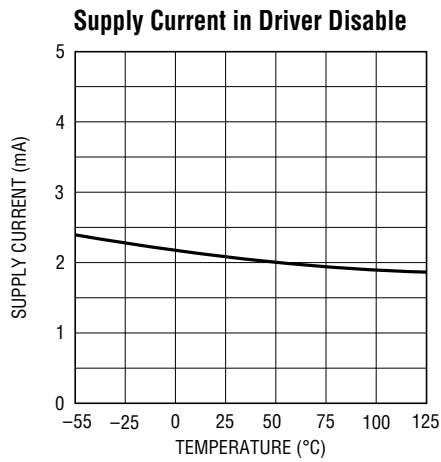

LT1342 • TPC05

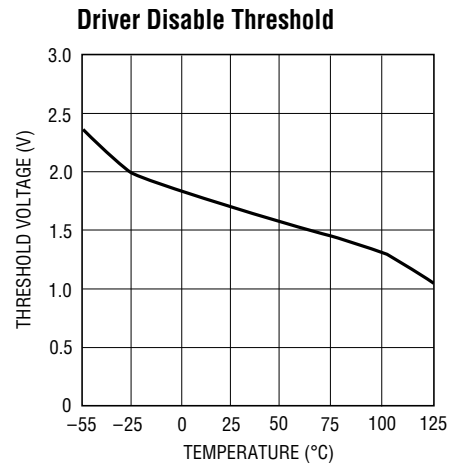

LT1342 • TPC06

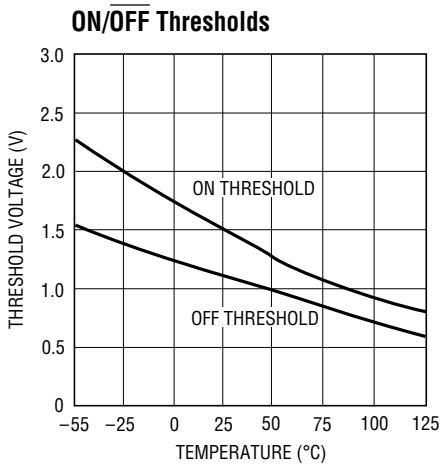

LT1342 • TPC07

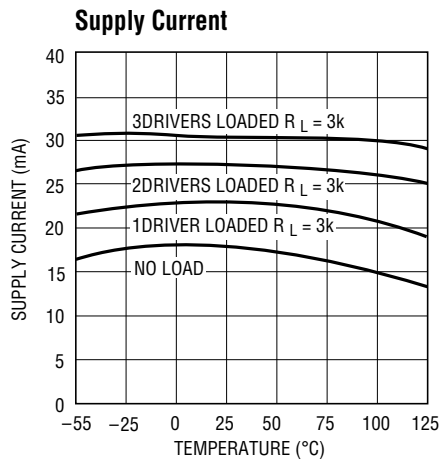

LT1341 • TPC08

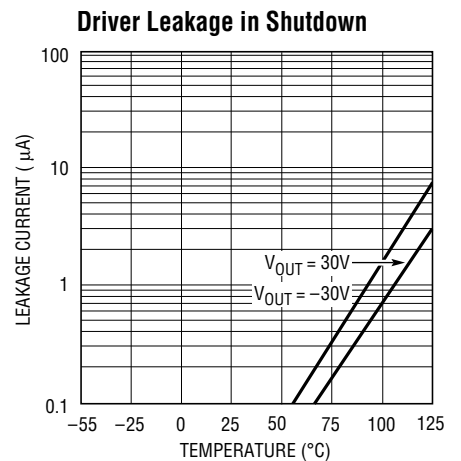

LT1342 • TPC09

TYPICAL PERFORMANCE CHARACTERISTICS

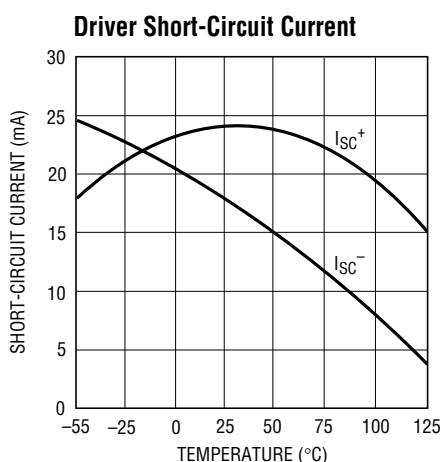

LT1342 • TPC10

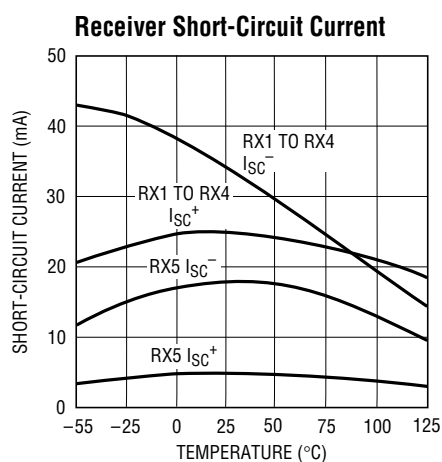

LT1342 • TPC11

Receiver Output Waveforms

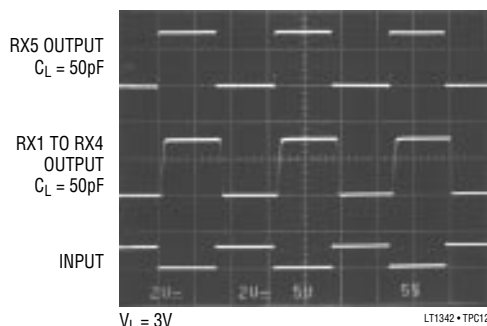

LT1342 • TPC12

Driver Output Waveforms

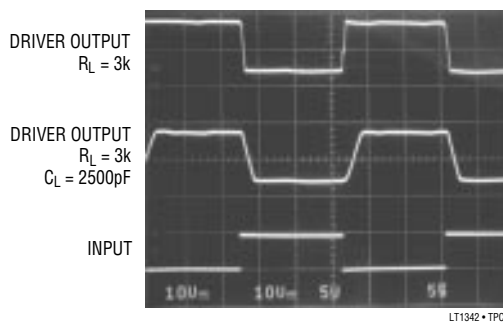

LT1342 • TPC13

PIN FUNCTIONS

V_{CC}: 5V Input Supply Pin. This pin should be decoupled with a 0.1μF ceramic capacitor close to the package pin. Insufficient supply bypassing can result in low output drive levels and erratic charge pump operation.

V_L: 3V Logic Supply Pin. Provides power to the receiver outputs. Decouple with a 0.1μF ceramic capacitor.

GND: Ground Pin.

ON/OFF: A TTL/CMOS Compatible Operating Mode Control. A logic low puts the device in the low power shutdown mode. Drivers and receivers assume a high impedance state in shutdown. The transceiver consumes almost no supply current while in shutdown. A logic high fully enables the transceiver. An ON/OFF logic low signal supersedes the state of the DRIVER DISABLE pin.

DRIVER DISABLE: This pin provides an alternate control for the charge pump and RS232 drivers. A logic high on this pin shuts down the charge pump and places all drivers in a high impedance state. All five receivers remain active under these conditions. Floating the DRIVER DISABLE pin or driving it to a logic low level fully enables the transceiver. A logic low on the ON/OFF pin supersedes the state of the DRIVER DISABLE pin. Supply current drops to 3mA when in driver disable mode.

V⁺: Positive Supply Output (RS232 Drivers). $V^+ \approx 2V_{CC} - 1.5V$. This pin requires an external charge storage capacitor $C \geq 0.1\mu F$, tied to ground or V_{CC} . With multiple transceivers, the V^+ and V^- pins may be paralleled into common charge storage capacitors. Larger value capacitors may be used to reduce supply ripple.

PIN FUNCTIONS

V⁻: Negative Supply Output (RS232 Drivers). $V^- \approx -(2V_{CC} - 2.5V)$. This pin requires an external charge storage capacitor $C \geq 0.1\mu F$. To reduce supply ripple, increase the size of the storage capacitor.

C1⁺, C1⁻, C2⁺, C2⁻: Commutating Capacitor Inputs. These pins require two external capacitors $C \geq 0.2\mu F$: one from C1⁺ to C1⁻, and another from C2⁺ to C2⁻. The capacitor's effective series resistance should be less than 2Ω. For $C \geq 1\mu F$, low ESR tantalum capacitors work well in this application, although small value ceramic capacitors may be used with a minimal reduction in charge pump compliance. For operation with an external 12V supply, omit C1 and connect the 12V supply to pin C1⁺. Pin V⁺ may also be shorted to C1⁺ when a separate supply is used. The 12V supply must be bypassed with a 0.1F capacitor.

DRIVER IN: RS232 Driver Input Pins. These inputs are compatible with TTL or CMOS logic. Tie unused inputs to V_{CC} or V_L .

DRIVER OUT: Driver Outputs at RS232 Voltage Levels. Driver output swing meets RS232 levels for loads up to 3k. Slew rates are controlled for lightly loaded lines. Output current capability is sufficient for load conditions up to 2500pF. Outputs are in a high impedance

state when in shutdown mode, $V_{CC} = 0V$, or when the DRIVER DISABLE pin is active. Outputs are fully short-circuit protected from $V^- + 30V$ to $V^+ - 30V$. Applying higher voltages will not damage the device if the overdrive is moderately current limited. Short circuits on one output can load the power supply generator and may disrupt the signal levels of the other outputs. The driver outputs are protected against ESD to $\pm 10V$ for human body model discharges.

RX IN: Receiver Inputs. These pins accept RS232 level signals ($\pm 30V$) into a protected 5k terminating resistor. The receiver inputs are protected against ESD to $\pm 10kV$ for human body model discharges. Each receiver provides 0.4V of hysteresis for noise immunity. Open receiver inputs assume a logic low state.

RX OUT: Receiver Outputs with 3.3V Logic Compatible Voltage Levels. Outputs are in a high impedance state when in shutdown mode to allow data line sharing. Outputs are fully short-circuit protected to ground or V_{CC} or V_L with the power on, off, or in shutdown mode. Receiver output level is determined by V_L supply voltage. Use $V_L = 3.3V$ for interfacing with 3.3V logic, $V_L = 5V$ for interfacing with 5V logic.

ESD PROTECTION

The RS232 line inputs of the LT1342 have on-chip protection from ESD transients up to $\pm 10kV$. The protection structures act to divert the static discharge safely to system ground. In order for the ESD protection to function effectively, the power supply and ground pins of the LT1342 must be connected to ground through low impedances. The power supply decoupling capacitors and charge pump storage capacitors provide this low impedance in normal application of the circuit. The only constraint is that low ESR capacitors must be used for bypassing and charge storage. ESD testing must be done with pins V_{CC} , V^+ , V^- and GND shorted to ground or connected with low ESR capacitors.

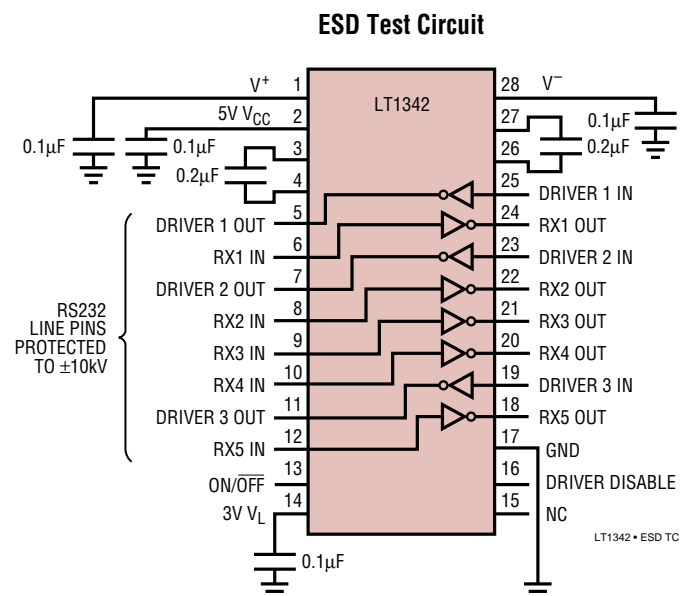

PACKAGE DESCRIPTION Dimensions in inches (millimeters) unless otherwise noted.

G Package
28-Lead Plastic SSOP (0.209)
 (LTC DWG # 05-08-1640)

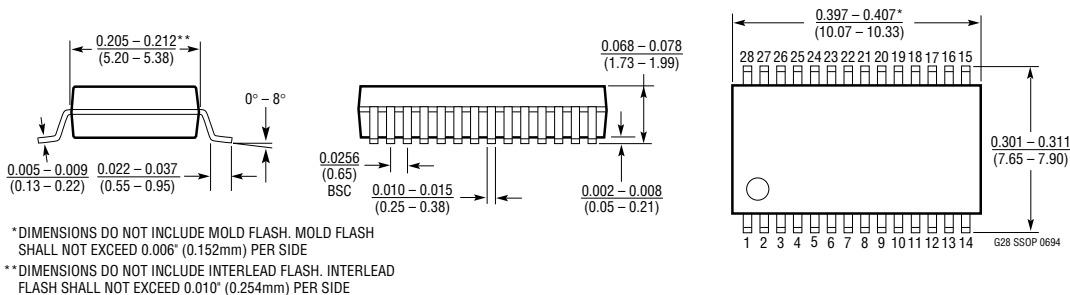

NW Package
28-Lead PDIP (Wide 0.600)
 (LTC DWG # 05-08-1520)

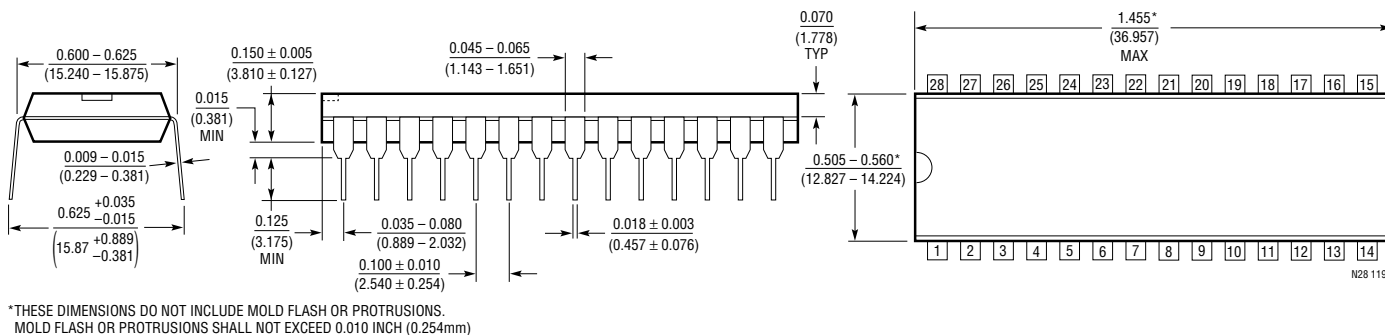

SW Package
28-Lead Plastic Small Outline (Wide 0.300)
 (LTC DWG # 05-08-1620)

