

90MHz, 22V/ μ s 16-Bit Accurate Operational Amplifier

FEATURES

- 90MHz Gain Bandwidth, $f = 100\text{kHz}$
- 22V/ μ s Slew Rate
- Settling Time: 900ns ($A_V = -1$, 150 μ V, 10V Step)
- Low Distortion, -96.5dB for 100kHz, 10V_{p-p}
- Maximum Input Offset Voltage: 75 μ V
- Maximum Input Offset Voltage Drift: 2 μ V/ $^{\circ}$ C
- Maximum (-) Input Bias Current: 10nA
- Minimum DC Gain: 1000V/mV
- Minimum Output Swing into 2k: $\pm 12.8\text{V}$
- Unity Gain Stable
- Input Noise Voltage: 5nV/ $\sqrt{\text{Hz}}$
- Input Noise Current: 0.6pA/ $\sqrt{\text{Hz}}$
- Total Input Noise Optimized for $1\text{k} < R_S < 20\text{k}$
- Specified at $\pm 5\text{V}$ and $\pm 15\text{V}$

APPLICATIONS

- 16-Bit DAC Current-to-Voltage Converter
- Precision Instrumentation
- ADC Buffer
- Low Distortion Active Filters
- High Accuracy Data Acquisition Systems
- Photodiode Amplifiers

DESCRIPTION

The LT[®]1468 is a precision high speed operational amplifier with 16-bit accuracy and 900ns settling to 150 μ V for 10V signals. This unique blend of precision and AC performance makes the LT1468 the optimum choice for high accuracy applications such as DAC current-to-voltage conversion and ADC buffers. The initial accuracy and drift characteristics of the input offset voltage and inverting input bias current are tailored for inverting applications.

The 90MHz gain bandwidth ensures high open-loop gain at frequency for reducing distortion. In noninverting applications such as an ADC buffer, the low distortion and DC accuracy allow full 16-bit AC and DC performance.

The 22V/ μ s slew rate of the LT1468 improves large-signal performance in applications such as active filters and instrumentation amplifiers compared to other precision op amps.

The LT1468 is manufactured on a complementary bipolar process. It is available in a space saving 3mm \times 3mm leadless package, as well as small outline and DIP packages.

LT, LT, LTC, LTM, Linear Technology and the Linear logo are registered trademarks of Linear Technology Corporation. All other trademarks are the property of their respective owners.

TYPICAL APPLICATION

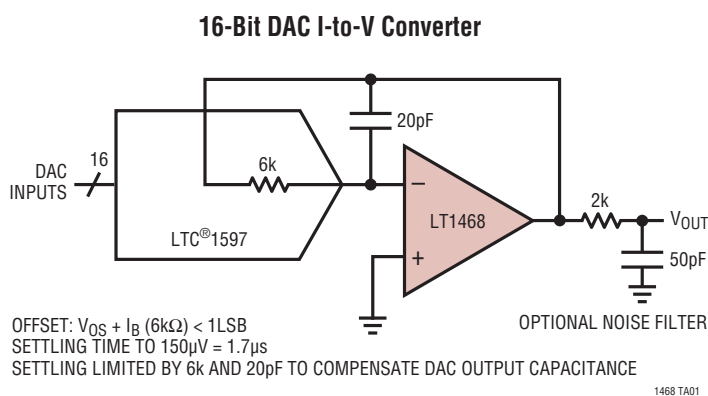

Total Harmonic Distortion vs Frequency

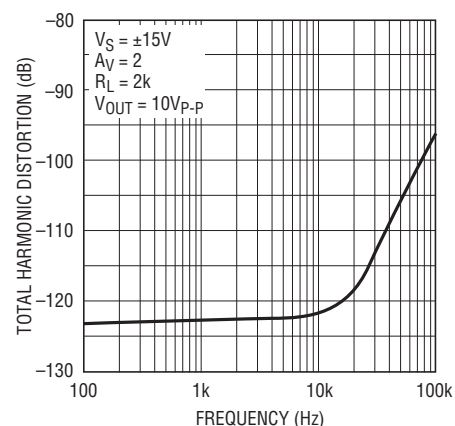

LT1468

ABSOLUTE MAXIMUM RATINGS (Note 1)

Total Supply Voltage (V^+ to V^-).....	36V	Specified Temperature Range (Note 4)	-40°C to 85°C
Maximum Input Current (Note 2).....	10mA	Junction Temperature	150°C
Output Short-Circuit Duration (Note 3)	Indefinite	Storage Temperature Range.....	-65°C to 150°C
Operating Temperature Range	-40°C to 85°C	Lead Temperature (Soldering, 10 sec)	300°C

PIN CONFIGURATION

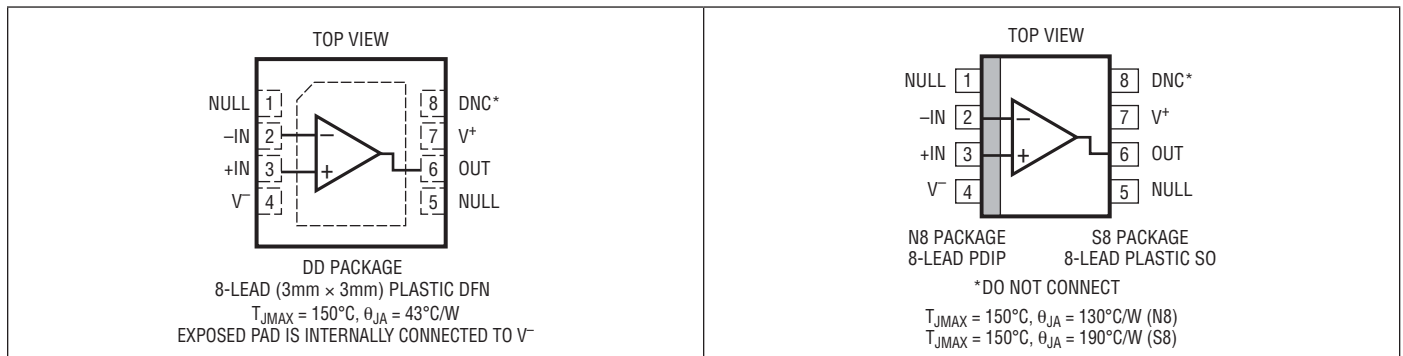

ORDER INFORMATION

LEAD FREE FINISH	TAPE AND REEL	PART MARKING*	PACKAGE DESCRIPTION	SPECIFIED TEMPERATURE RANGE
LT1468CN8#PBF	NA	LT1468CN8	8-Lead PDIP	0°C to 70°C
LT1468IN8#PBF	NA	LT1468IN8	8-Lead PDIP	-40°C to 85°C
LT1468CS8#PBF	LT1468CS8#TRPBF	1468	8-Lead Plastic Small Outline	0°C to 70°C
LT1468IS8#PBF	LT1468IS8#TRPBF	1468I	8-Lead Plastic Small Outline	-40°C to 85°C
LT1468ACDD#PBF	LT1468ACDD#TRPBF	LDJX	8-Lead (3mm × 3mm) Plastic DFN	0°C to 70°C
LT1468AIDD#PBF	LT1468AIDD#TRPBF	LDJX	8-Lead (3mm × 3mm) Plastic DFN	-40°C to 85°C
LT1468CDD#PBF	LT1468CDD#TRPBF	LDJX	8-Lead (3mm × 3mm) Plastic DFN	0°C to 70°C
LT1468IDD#PBF	LT1468IDD#TRPBF	LDJX	8-Lead (3mm × 3mm) Plastic DFN	-40°C to 85°C
LEAD BASED FINISH	TAPE AND REEL	PART MARKING	PACKAGE DESCRIPTION	SPECIFIED TEMPERATURE RANGE
LT1468CN8	NA	LT1468CN8	8-Lead PDIP	0°C to 70°C
LT1468IN8	NA	LT1468IN8	8-Lead PDIP	-40°C to 85°C
LT1468CS8	LT1468CS8#TR	1468	8-Lead Plastic Small Outline	0°C to 70°C
LT1468IS8	LT1468IS8#TR	1468I	8-Lead Plastic Small Outline	-40°C to 85°C

Consult LTC Marketing for parts specified with wider operating temperature ranges. *The temperature grade is identified by a label on the shipping container.

For more information on lead free part marking, go to: <http://www.linear.com/leadfree/>

For more information on tape and reel specifications, go to: <http://www.linear.com/tapeandreel/>

ELECTRICAL CHARACTERISTICS The ● denotes the specifications which apply over the full operating temperature range, otherwise specifications are at $T_A = 25^\circ\text{C}$. $V_{CM} = 0\text{V}$ unless otherwise noted.

SYMBOL	PARAMETER	CONDITIONS	V_{SUPPLY}	MIN	TYP	MAX	UNITS
V_{OS}	Input Offset Voltage	N8, S8	$\pm 15\text{V}$ $\pm 5\text{V}$		30 50	75 175	μV μV
		LT1468A, DD Package	$\pm 15\text{V}$ $\pm 5\text{V}$		30 50	75 175	μV μV
		LT1468, DD Package	$\pm 15\text{V}$ $\pm 5\text{V}$		100 150	200 300	μV μV
I_{OS}	Input Offset Current		$\pm 5\text{V}$ to $\pm 15\text{V}$		13	50	nA
I_{B^-}	Inverting Input Bias Current		$\pm 5\text{V}$ to $\pm 15\text{V}$		3	± 10	nA
I_{B^+}	Noninverting Input Bias Current		$\pm 5\text{V}$ to $\pm 15\text{V}$		-10	± 40	nA
	Input Noise Voltage	0.1Hz to 10Hz	$\pm 5\text{V}$ to $\pm 15\text{V}$		0.3		μV_{P-P}
e_n	Input Noise Voltage	$f = 10\text{kHz}$	$\pm 5\text{V}$ to $\pm 15\text{V}$		5		$\text{nV}/\sqrt{\text{Hz}}$
i_n	Input Noise Voltage	$f = 10\text{kHz}$	$\pm 5\text{V}$ to $\pm 15\text{V}$		0.6		$\text{pA}/\sqrt{\text{Hz}}$
R_{IN}	Input Resistance	$V_{CM} = \pm 12.5\text{V}$ Differential	$\pm 15\text{V}$	100	240		$\text{M}\Omega$
			$\pm 5\text{V}$	50	150		$\text{k}\Omega$
C_{IN}	Input Capacitance		$\pm 15\text{V}$		4		pF
	Input Voltage Range +		$\pm 15\text{V}$ $\pm 5\text{V}$	12.5 2.5	13.5 3.5		V V
	Input Voltage Range -		$\pm 15\text{V}$ $\pm 5\text{V}$		-14.3 -4.3	-12.5 -2.5	V V
CMRR	Common Mode Rejection Ratio	$V_{CM} = \pm 12.5\text{V}$ $V_{CM} = \pm 2.5\text{V}$	$\pm 15\text{V}$	96	110		dB
			$\pm 5\text{V}$	96	112		dB
PSRR	Power Supply Rejection Ratio	$V_S = \pm 4.5\text{V}$ to $\pm 15\text{V}$		100	112		dB
A_{VOL}	Large-Signal Voltage Gain	$V_{OUT} = \pm 12.5\text{V}$, $R_L = 10\text{k}$ $V_{OUT} = \pm 12.5\text{V}$, $R_L = 2\text{k}$ $V_{OUT} = \pm 2.5\text{V}$, $R_L = 10\text{k}$ $V_{OUT} = \pm 2.5\text{V}$, $R_L = 2\text{k}$	$\pm 15\text{V}$	1000	9000		V/mV
			$\pm 15\text{V}$	500	5000		V/mV
			$\pm 5\text{V}$	1000	6000		V/mV
			$\pm 5\text{V}$	500	3000		V/mV
V_{OUT}	Output Swing	$R_L = 10\text{k}$ $R_L = 2\text{k}$ $R_L = 10\text{k}$ $R_L = 2\text{k}$	$\pm 15\text{V}$	± 13.0	± 13.6		V
			$\pm 15\text{V}$	± 12.8	± 13.5		V
			$\pm 5\text{V}$	± 3.0	± 3.6		V
			$\pm 5\text{V}$	± 2.8	± 3.5		V
I_{OUT}	Output Current	$V_{OUT} = \pm 12.5\text{V}$ $V_{OUT} = \pm 2.5\text{V}$	$\pm 15\text{V}$	± 15	± 22		mA
			$\pm 5\text{V}$	± 15	± 22		mA
I_{SC}	Short-Circuit Current	$V_{OUT} = 0\text{V}$, $V_{IN} = \pm 0.2\text{V}$	$\pm 15\text{V}$	± 25	± 40		mA
SR	Slew Rate	$A_V = -1$, $R_L = 2\text{k}$ (Note 5)	$\pm 15\text{V}$ $\pm 5\text{V}$	15 11	22 17		V/ μs V/ μs
	Full-Power Bandwidth	10V Peak, (Note 6) 3V Peak, (Note 6)	$\pm 15\text{V}$ $\pm 5\text{V}$		350 900		kHz kHz
GBW	Gain Bandwidth	$f = 100\text{kHz}$, $R_L = 2\text{k}$	$\pm 15\text{V}$	60	90		MHz
			$\pm 5\text{V}$	55	88		MHz
THD	Total Harmonic Distortion	$A_V = 2$, $V_O = 10\text{V}_{P-P}$, $f = 1\text{kHz}$ $A_V = 2$, $V_O = 10\text{V}_{P-P}$, $f = 100\text{kHz}$	$\pm 15\text{V}$		0.00007		%
			$\pm 15\text{V}$		0.0015		%
t_r , t_f	Rise Time, Fall Time	$A_V = 1$, 10% to 90%, 0.1V	$\pm 15\text{V}$ $\pm 5\text{V}$		11 12		ns ns
	Overshoot	$A_V = 1$, 0.1V	$\pm 15\text{V}$ $\pm 5\text{V}$		30 35		% %
	Propagation Delay	$A_V = 1$, 50% V_{IN} to 50% V_{OUT} , 0.1V	$\pm 15\text{V}$ $\pm 5\text{V}$		9 10		ns ns

ELECTRICAL CHARACTERISTICS

The ● denotes the specifications which apply over the full operating temperature range, otherwise specifications are at $T_A = 25^\circ\text{C}$. $V_{CM} = 0\text{V}$ unless otherwise noted.

SYMBOL	PARAMETER	CONDITIONS	V_{SUPPLY}	MIN	TYP	MAX	UNITS
t_s	Settling Time	10V Step, 0.01%, $A_V = -1$	$\pm 15\text{V}$		760		ns
		10V Step, $150\mu\text{V}$, $A_V = -1$	$\pm 15\text{V}$		900		ns
		5V Step, 0.01%, $A_V = -1$	$\pm 5\text{V}$		770		ns
R_O	Output Resistance	$A_V = 1$, $f = 100\text{kHz}$	$\pm 15\text{V}$		0.02		Ω
I_S	Supply Current		$\pm 15\text{V}$		3.9	5.2	mA
			$\pm 5\text{V}$		3.6	5.0	mA

The ● denotes the specifications which apply over the full operating temperature range, otherwise specifications are at $T_A = 25^\circ\text{C}$. $0^\circ\text{C} \leq T_A \leq 70^\circ\text{C}$, $V_{CM} = 0\text{V}$ unless otherwise noted.

SYMBOL	PARAMETER	CONDITIONS	V_{SUPPLY}	MIN	TYP	MAX	UNITS
V_{OS}	Input Offset Voltage	N8, S8	$\pm 15\text{V}$ $\pm 5\text{V}$	● ●		150 250	μV μV
		LT1468A, DD Package	$\pm 15\text{V}$ $\pm 5\text{V}$	● ●		150 250	μV μV
		LT1468, DD Package	$\pm 15\text{V}$ $\pm 5\text{V}$	● ●		300 400	μV μV
	Input V_{OS} Drift	(Note 7)	$\pm 5\text{V}$ to $\pm 15\text{V}$	●	0.7	2.0	$\mu\text{V}/^\circ\text{C}$
I_{OS}	Input Offset Current		$\pm 5\text{V}$ to $\pm 15\text{V}$	●		65	nA
	Input Offset Current Drift		$\pm 5\text{V}$ to $\pm 15\text{V}$		60		$\text{pA}/^\circ\text{C}$
I_{B^-}	Inverting Input Bias Current		$\pm 5\text{V}$ to $\pm 15\text{V}$	●		± 15	nA
	Negative Input Current Drift		$\pm 5\text{V}$ to $\pm 15\text{V}$		40		$\text{pA}/^\circ\text{C}$
I_{B^+}	Noninverting Input Bias Current		$\pm 5\text{V}$ to $\pm 15\text{V}$	●		± 50	nA
CMRR	Common Mode Rejection Ratio	$V_{CM} = \pm 12.5\text{V}$	$\pm 15\text{V}$	●	94		dB
		$V_{CM} = \pm 2.5\text{V}$	$\pm 5\text{V}$	●	94		dB
PSRR	Power Supply Rejection Ratio	$V_S = \pm 4.5\text{V}$ to $\pm 15\text{V}$		●	98		dB
A_{VOL}	Large-Signal Voltage Gain	$V_{OUT} = \pm 12.5\text{V}$, $R_L = 10\text{k}$	$\pm 15\text{V}$	●	500		V/mV
		$V_{OUT} = \pm 12.5\text{V}$, $R_L = 2\text{k}$	$\pm 15\text{V}$	●	250		V/mV
		$V_{OUT} = \pm 2.5\text{V}$, $R_L = 10\text{k}$	$\pm 5\text{V}$	●	500		V/mV
		$V_{OUT} = \pm 2.5\text{V}$, $R_L = 2\text{k}$	$\pm 5\text{V}$	●	250		V/mV
V_{OUT}	Output Swing	$R_L = 10\text{k}$	$\pm 15\text{V}$	●	± 12.9		V
		$R_L = 2\text{k}$	$\pm 15\text{V}$	●	± 12.7		V
		$R_L = 10\text{k}$	$\pm 5\text{V}$	●	± 2.9		V
		$R_L = 2\text{k}$	$\pm 5\text{V}$	●	± 2.7		V
I_{OUT}	Output Current	$V_{OUT} = \pm 12.5\text{V}$	$\pm 15\text{V}$	●	± 12.5		mA
		$V_{OUT} = \pm 2.5\text{V}$	$\pm 5\text{V}$	●	± 12.5		mA
I_{SC}	Short-Circuit Current	$V_{OUT} = 0\text{V}$, $V_{IN} = \pm 0.2\text{V}$	$\pm 15\text{V}$	●	± 17		mA
SR	Slew Rate	$A_V = -1$, $R_L = 2\text{k}$ (Note 5)	$\pm 15\text{V}$	●	13		V/ μs
			$\pm 5\text{V}$	●	9		V/ μs
GBW	Gain Bandwidth	$f = 100\text{kHz}$, $R_L = 2\text{k}$	$\pm 15\text{V}$	●	55		MHz
			$\pm 5\text{V}$	●	50		MHz
I_S	Supply Current		$\pm 15\text{V}$	●		6.5	mA
			$\pm 5\text{V}$	●		6.3	mA

ELECTRICAL CHARACTERISTICS The ● denotes the specifications which apply over the full operating temperature range, otherwise specifications are at $T_A = 25^\circ\text{C}$. $-40^\circ\text{C} \leq T_A \leq 85^\circ\text{C}$, $V_{CM} = 0\text{V}$ unless otherwise noted.

SYMBOL	PARAMETER	CONDITIONS	V_{SUPPLY}		MIN	TYP	MAX	UNITS
V_{OS}	Input Offset Voltage	N8, S8	$\pm 15\text{V}$	●			230	μV
			$\pm 5\text{V}$	●			330	μV
		LT1468A, DD Package	$\pm 15\text{V}$	●			230	μV
			$\pm 5\text{V}$	●			330	μV
		LT1468, DD Package	$\pm 15\text{V}$	●			400	μV
			$\pm 5\text{V}$	●			500	μV
	Input V_{OS} Drift	(Note 7)	$\pm 5\text{V}$ to $\pm 15\text{V}$	●		0.7	2.5	$\mu\text{V}/^\circ\text{C}$
I_{OS}	Input Offset Current		$\pm 5\text{V}$ to $\pm 15\text{V}$	●			80	nA
	Input Offset Current Drift		$\pm 5\text{V}$ to $\pm 15\text{V}$			120		$\text{pA}/^\circ\text{C}$
I_{B^-}	Inverting Input Bias Current		$\pm 5\text{V}$ to $\pm 15\text{V}$	●			± 30	nA
	Negative Input Current Drift		$\pm 5\text{V}$ to $\pm 15\text{V}$			80		$\text{pA}/^\circ\text{C}$
I_{B^+}	Noninverting Input Bias Current		$\pm 5\text{V}$ to $\pm 15\text{V}$	●			± 60	nA
CMRR	Common Mode Rejection Ratio	$V_{CM} = \pm 12.5\text{V}$	$\pm 15\text{V}$	●	92			dB
		$V_{CM} = \pm 2.5\text{V}$	$\pm 5\text{V}$	●	92			dB
PSRR	Power Supply Rejection Ratio	$V_S = \pm 4.5\text{V}$ to $\pm 15\text{V}$		●	96			dB
A_{VOL}	Large-Signal Voltage Gain	$V_{OUT} = \pm 12\text{V}$, $R_L = 10\text{k}$	$\pm 15\text{V}$	●	300			V/mV
		$V_{OUT} = \pm 10\text{V}$, $R_L = 2\text{k}$	$\pm 15\text{V}$	●	150			V/mV
		$V_{OUT} = \pm 2.5\text{V}$, $R_L = 10\text{k}$	$\pm 5\text{V}$	●	300			V/mV
		$V_{OUT} = \pm 2.5\text{V}$, $R_L = 2\text{k}$	$\pm 5\text{V}$	●	150			V/mV
V_{OUT}	Output Swing	$R_L = 10\text{k}$	$\pm 15\text{V}$	●	± 12.8			V
		$R_L = 2\text{k}$	$\pm 15\text{V}$	●	± 12.6			V
		$R_L = 10\text{k}$	$\pm 5\text{V}$	●	± 2.8			V
		$R_L = 2\text{k}$	$\pm 5\text{V}$	●	± 2.6			V
I_{OUT}	Output Current	$V_{OUT} = \pm 12.5\text{V}$	$\pm 15\text{V}$	●	± 7			mA
		$V_{OUT} = \pm 2.5\text{V}$	$\pm 5\text{V}$	●	± 7			mA
I_{SC}	Short-Circuit Current	$V_{OUT} = 0\text{V}$, $V_{IN} = \pm 0.2\text{V}$	$\pm 15\text{V}$	●	± 12			mA
SR	Slew Rate	$A_V = -1$, $R_L = 2\text{k}$ (Note 5)	$\pm 15\text{V}$	●	9			V/ μs
			$\pm 5\text{V}$	●	6			V/ μs
GBW	Gain Bandwidth	$f = 100\text{kHz}$, $R_L = 2\text{k}$	$\pm 15\text{V}$	●	45			MHz
			$\pm 5\text{V}$	●	40			MHz
I_S	Supply Current		$\pm 15\text{V}$	●			7.0	mA
			$\pm 5\text{V}$	●			6.8	mA

Note 1: Stresses beyond those listed under Absolute Maximum Ratings may cause permanent damage to the device. Exposure to any Absolute Maximum Rating condition for extended periods may affect device reliability and lifetime.

Note 2: The inputs are protected by back-to-back diodes and two 100 Ω series resistors. If the differential input voltage exceeds 0.7V, the input current should be limited to 10mA. Input voltages outside the supplies will be clamped by ESD protection devices and input currents should also be limited to 10mA.

Note 3: A heat sink may be required to keep the junction temperature below absolute maximum when the output is shorted indefinitely.

Note 4: The LT1468C is guaranteed to meet specified performance from 0 $^\circ\text{C}$ to 70 $^\circ\text{C}$ and is designed, characterized and expected to meet these extended temperature limits, but is not tested at -40 $^\circ\text{C}$ and at 85 $^\circ\text{C}$. The LT1468I is guaranteed to meet the extended temperature limits.

Note 5: Slew rate is measured between $\pm 8\text{V}$ on the output with $\pm 12\text{V}$ input for $\pm 15\text{V}$ supplies and $\pm 2\text{V}$ on the output with $\pm 3\text{V}$ input for $\pm 5\text{V}$ supplies.

Note 6: Full power bandwidth is calculated from the slew rate measurement: $\text{FPBW} = \text{SR}/2\pi V_P$

Note 7: This parameter is not 100% tested.

TYPICAL PERFORMANCE CHARACTERISTICS

Supply Current vs Supply Voltage and Temperature

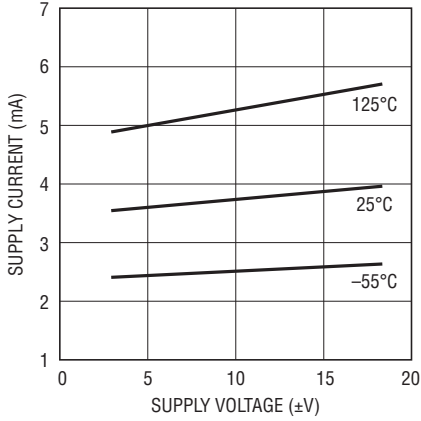

1468 G01

Input Common Mode Range vs Supply Voltage

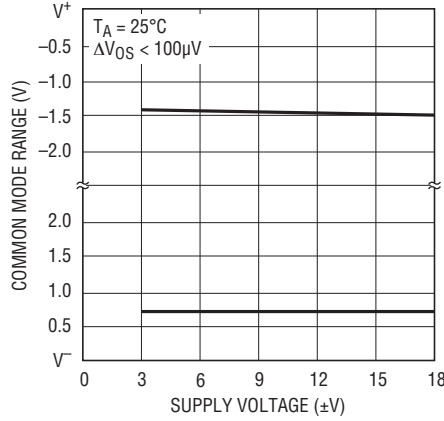

1468 G02

Input Bias Current vs Input Common Mode Voltage

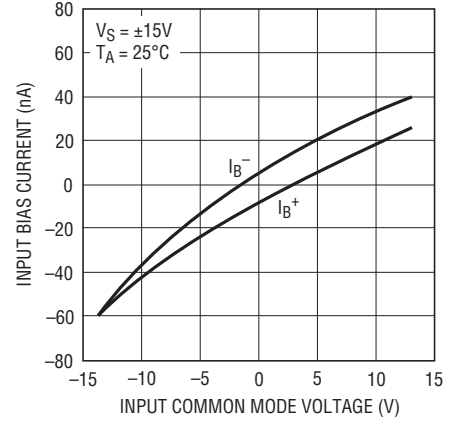

1468 G03

Input Bias Current vs Temperature

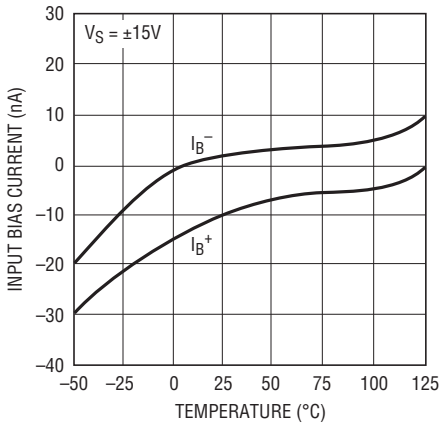

1468 G04

Input Noise Spectral Density

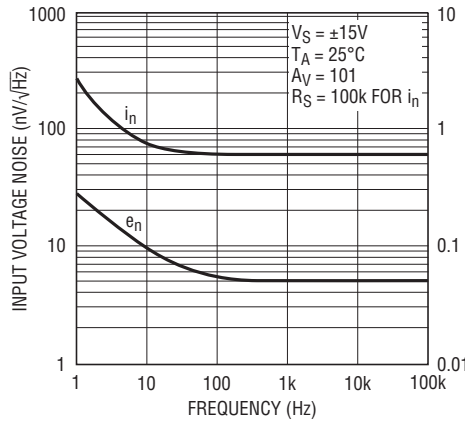

1468 G05

0.1Hz to 10Hz Voltage Noise

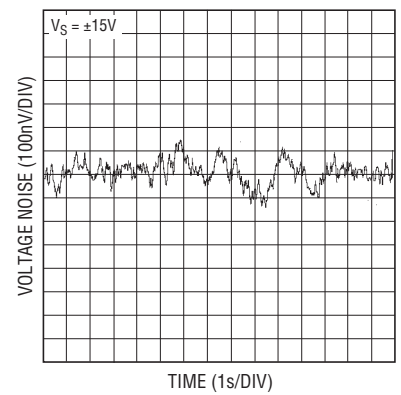

1468 G06

Warm-Up Drift vs Time

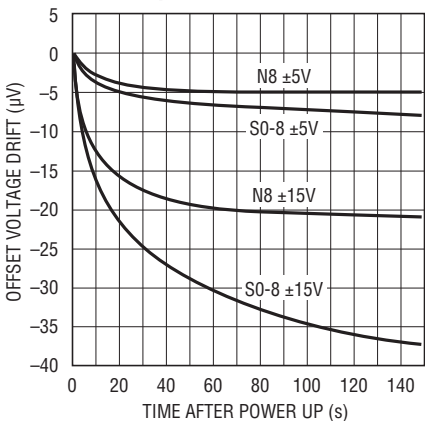

1468 G07

Open-Loop Gain vs Resistive Load

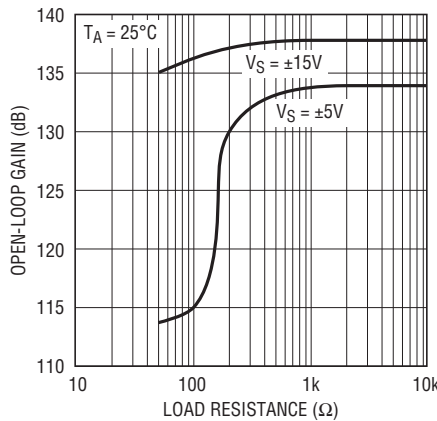

1468 G08

Open-Loop Gain vs Temperature

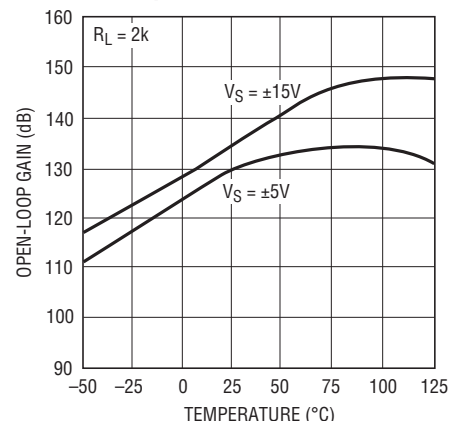

1468 G09

TYPICAL PERFORMANCE CHARACTERISTICS

Output Voltage Swing vs Supply Voltage

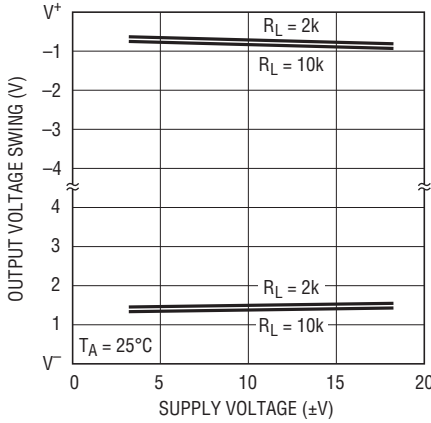

1468 G10

Output Voltage Swing vs Load Current

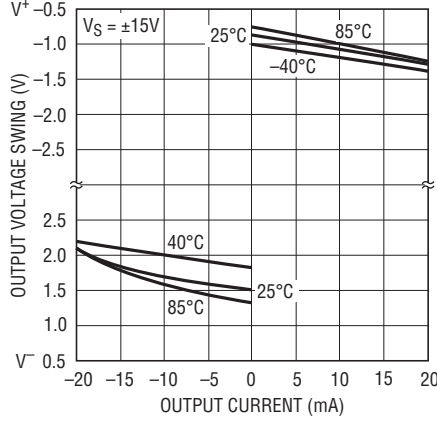

1468 G11

Output Short-Circuit Current vs Temperature

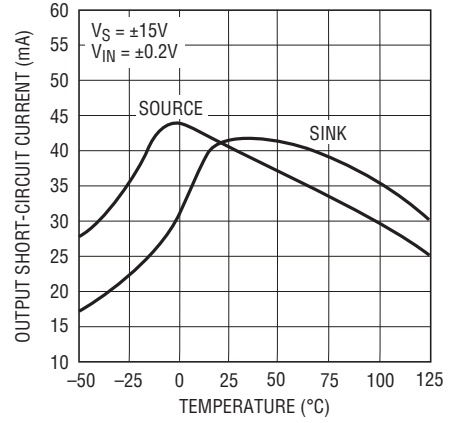

1468 G12

Settling Time to 0.01% vs Output Step, VS = ±15V

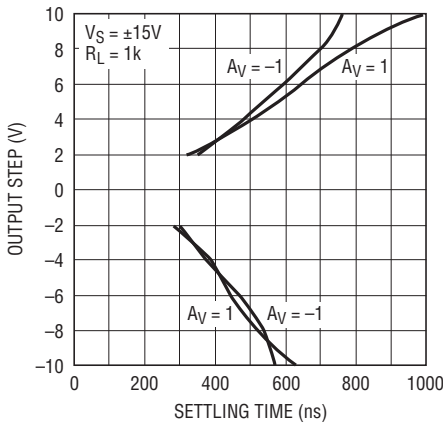

1468 G13

Settling Time to 0.01% vs Output Step, VS = ±5V

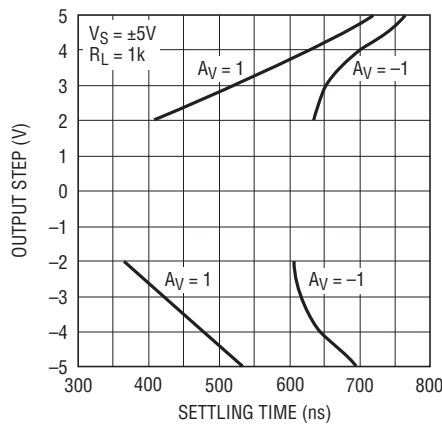

1468 G14

Settling Time to 150µV vs Output Step

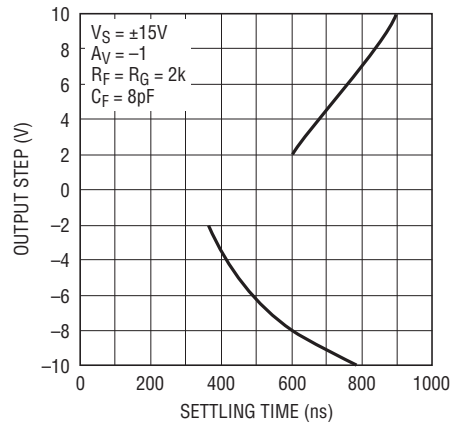

1468 G15

Gain Bandwidth and Phase Margin vs Supply Voltage

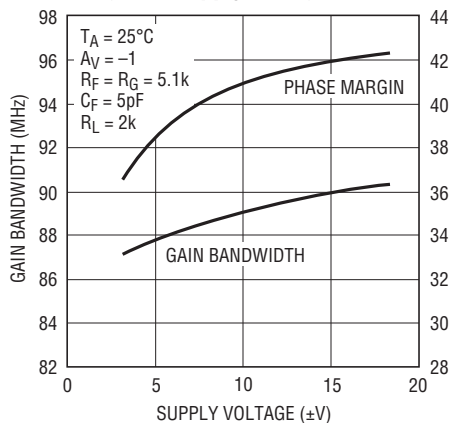

1468 G17

Gain Bandwidth and Phase Margin vs Temperature

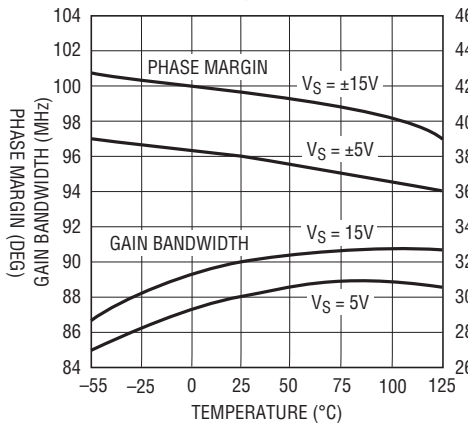

1468 G18

Output Impedance vs Frequency

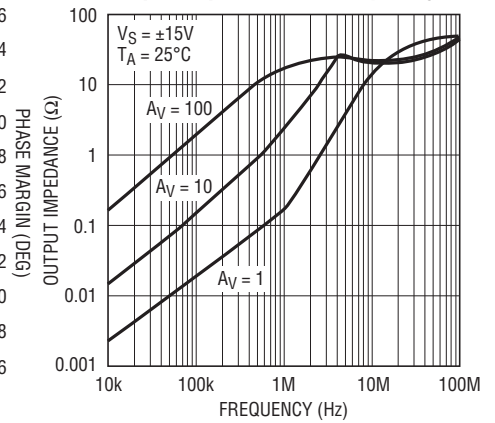

1468 G19

TYPICAL PERFORMANCE CHARACTERISTICS

Gain and Phase vs Frequency

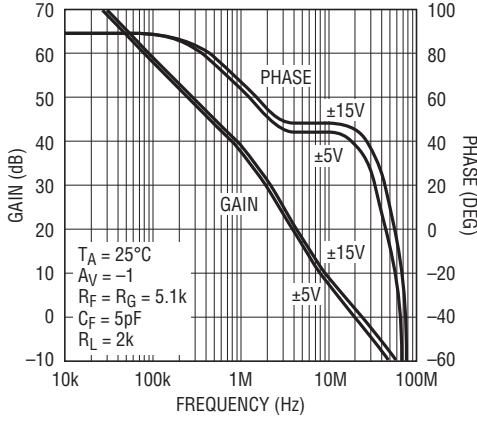

1468 G16

Power Supply Rejection Ratio vs Frequency

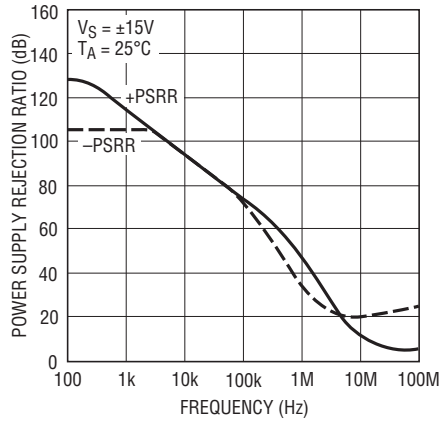

1468 G20

Common Mode Rejection Ratio vs Frequency

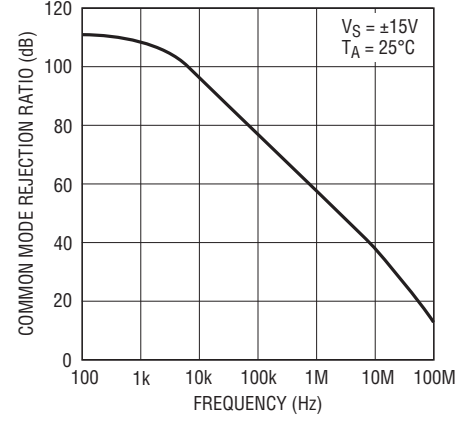

1468 G21

Frequency Response vs Supply Voltage, AV = 1

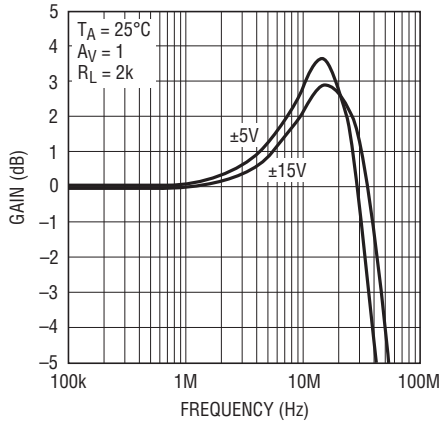

1468 G22

Frequency Response vs Supply Voltage, AV = -1

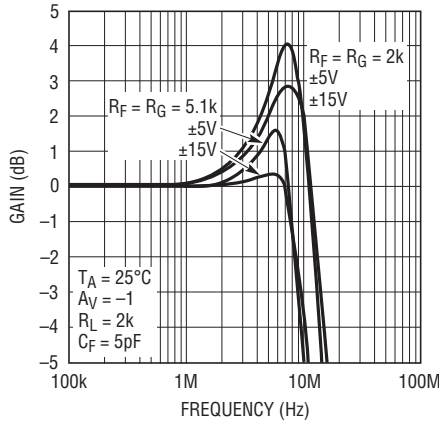

1468 G23

Frequency Response vs Capacitive Load, AV = 1

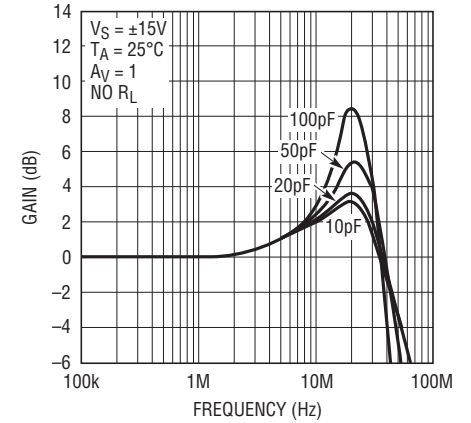

1468 G24

Frequency Response vs Capacitive Load, AV = -1

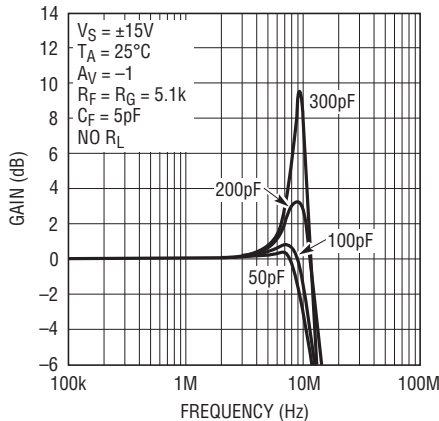

1468 G25

Slew Rate vs Supply Voltage

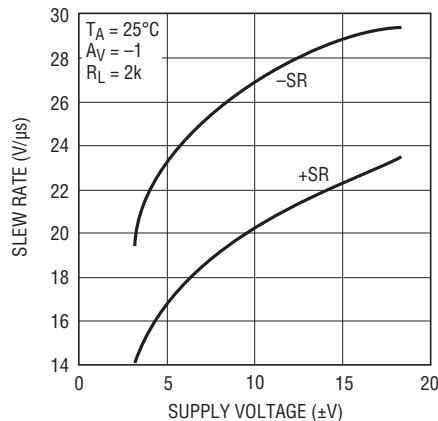

1468 G26

Slew Rate vs Temperature

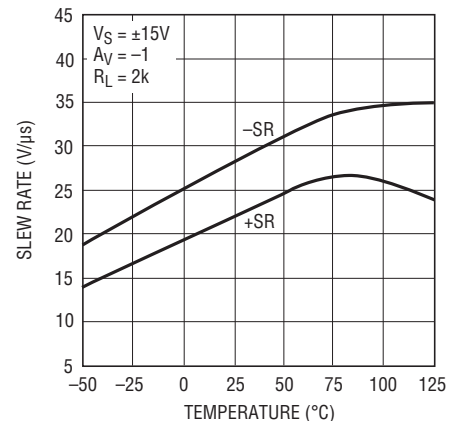

1468 G27

TYPICAL PERFORMANCE CHARACTERISTICS

Total Harmonic Distortion + Noise vs Frequency

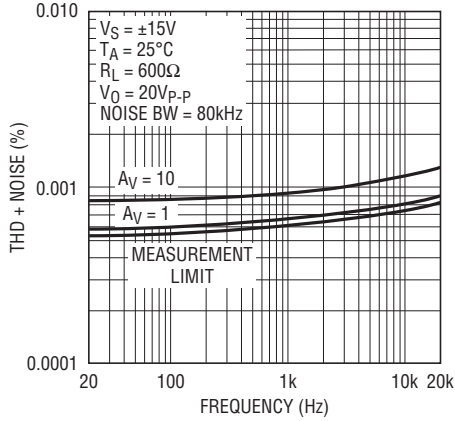

1468 G28

Total Harmonic Distortion + Noise vs Amplitude

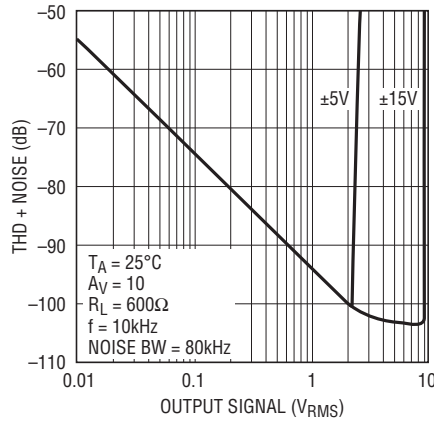

1468 G29

Undistorted Output Swing vs Frequency, ±15V

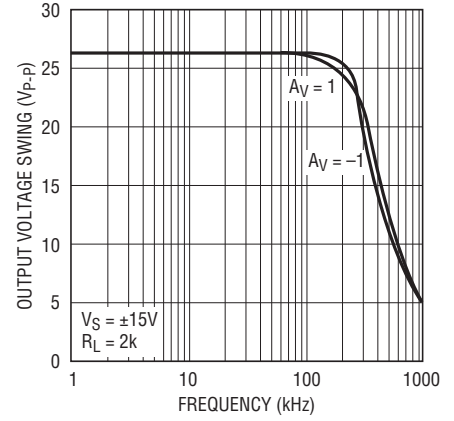

1468 G30

Small-Signal Transient, $A_V = 1$

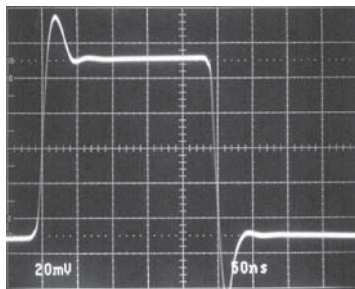

$V_S = \pm 15V$

1468 G31

Small-Signal Transient, $A_V = -1$

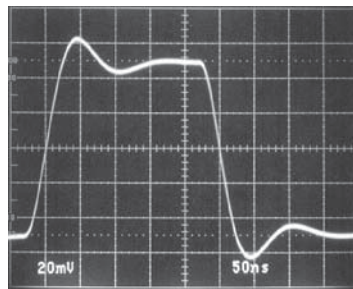

$V_S = \pm 15V$

1468 G32

Undistorted Output Swing vs Frequency, ±5V

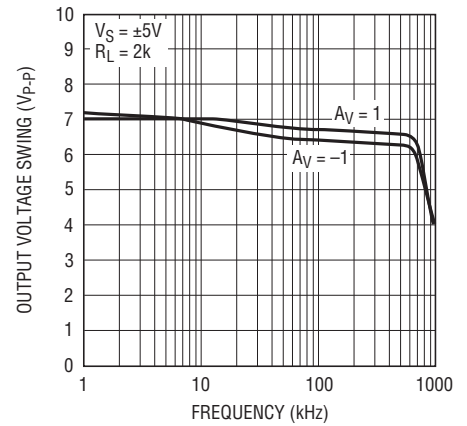

1468 G33

Large-Signal Transient, $A_V = 1$

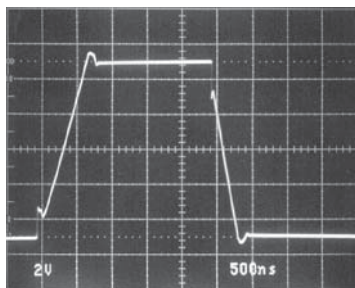

$V_S = \pm 15V$

1468 G34

Large-Signal Transient, $A_V = -1$

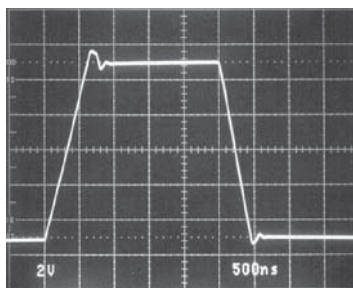

$V_S = \pm 15V$

1468 G35

Total Noise vs Unmatched Source Resistance

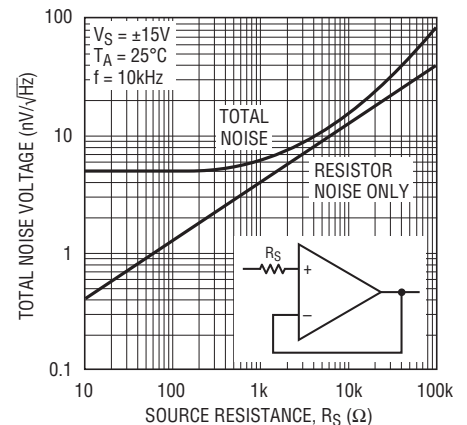

1468 G36

APPLICATIONS INFORMATION

The LT1468 may be inserted directly into many operational amplifier applications improving both DC and AC performance, provided that the nulling circuitry is removed. The suggested nulling circuit for the LT1468 is shown below.

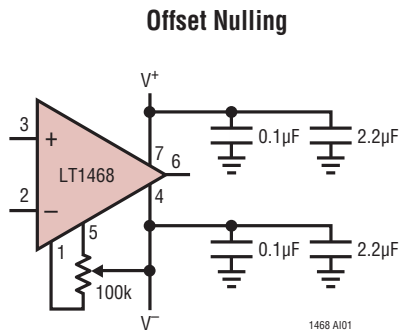

Layout and Passive Components

The LT1468 requires attention to detail in board layout in order to maximize DC and AC performance. For best AC results (for example fast settling time) use a ground plane, short lead lengths, and RF-quality bypass capacitors (0.01µF to 0.1µF) in parallel with low ESR bypass capacitors (1µF to 10µF tantalum). For best DC performance, use “star” grounding techniques, equalize input trace lengths and minimize leakage (i.e., 1.5GΩ of leakage between an input and a 15V supply will generate 10nA—equal to the maximum I_{B^-} specification.)

Board leakage can be minimized by encircling the input circuitry with a guard ring operated at a potential close to that of the inputs. For inverting configurations tie the ring to ground, in noninverting connections tie the ring to the inverting input (note the input capacitance will increase which may require a compensating capacitor as discussed below.)

Microvolt level error voltages can also be generated in the external circuitry. Thermocouple effects caused by temperature gradients across dissimilar metals at the

contacts to the inputs can exceed the inherent drift of the amplifier. Air currents over device leads should be minimized, package leads should be short, and the two input leads should be as close together as possible and maintained at the same temperature.

Make no connection to Pin 8. This pin is used for factory trim of the inverting input current.

The parallel combination of the feedback resistor and gain setting resistor on the inverting input can combine with the input capacitance to form a pole that can cause peaking or even oscillations. For feedback resistors greater than 2k, a feedback capacitor of the value:

$$C_F > (R_G)(C_{IN}/R_F)$$

should be used to cancel the input pole and optimize dynamic performance. For applications where the DC noise gain is one, and a large feedback resistor is used, C_F should be greater than or equal to C_{IN} . An example would be a DAC I-to-V converter as shown on the front page of this data sheet where the DAC can have many tens of pF of output capacitance. Another example would be a gain of -1 with 5k resistors; a 5pF to 10pF capacitor should be added across the feedback resistor. The frequency response in a gain of -1 is shown in the Typical Performance curves with 2k and 5.1k resistors with a 5pF feedback capacitor.

Nulling Input Capacitance

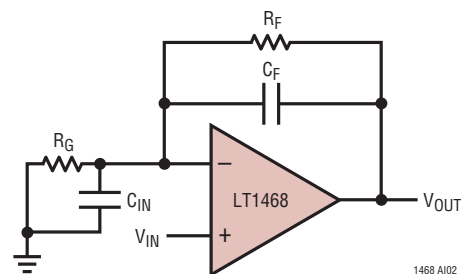

APPLICATIONS INFORMATION

Input Considerations

Each input of the LT1468 is protected with a 100Ω series resistor and back-to-back diodes across the bases of the input devices. If the inputs can be pulled apart, the input current should be limited to less than 10mA with an external series resistor. Each input also has two ESD clamp diodes—one to each supply. If an input is driven above the supply, limit the current with an external resistor to less than 10mA.

The LT1468 employs bias current cancellation at the inputs. The inverting input current is trimmed at zero common mode voltage to minimize errors in inverting applications such as I-to-V converters. The noninverting input current is not trimmed and has a wider variation and therefore a larger maximum value. As the input offset current can be greater than either input current, the use of balanced source resistance is NOT recommended as it actually degrades DC accuracy and also increases noise.

The input bias currents vary with common mode voltage as shown in the Typical Performance Characteristics. The cancellation circuitry was not designed to track this common mode voltage because the settling time would have been adversely affected.

The LT1468 inputs can be driven to the negative supply and to within 0.5V of the positive supply without phase reversal. As the input moves closer than 0.5V to the positive supply, the output reverses phase.

Total Input Noise

The curve of Total Noise vs Unmatched Source Resistance in the Typical Performance Characteristics shows that with source resistance below 1k, the voltage noise of the amplifier dominates. In the 1k to 20k region the increase in noise is due to the source resistance. Above 20k the input current noise component is larger than the resistor noise.

Capacitive Loading

The LT1468 drives capacitive loads of up to 100pF in unity gain and 300pF in a gain of -1. When there is a need to drive a larger capacitive load, a small series resistor should be inserted between the output and the load. In addition, a capacitor should be added between the output and the inverting input as shown in Driving Capacitive Loads.

Settling Time

The LT1468 is a single stage amplifier with an optimal thermal layout that leads to outstanding settling performance. Measuring settling, even at the 12-bit level is very challenging, and at the 16-bit level requires a great deal of subtlety and expertise. Fortunately, there are two excellent Linear Technology reference sources for settling measurements, Application Notes 47 and 74. Appendix B of AN47 is a vital primer on 12-bit settling measurements, and AN74 extends the state of the art while concentrating on settling time with a 16-bit current output DAC input.

Input Stage Protection

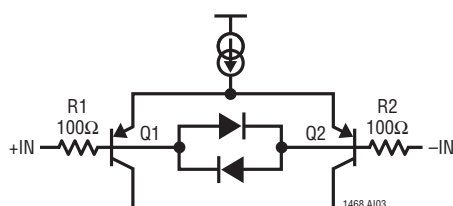

Driving Capacitive Loads

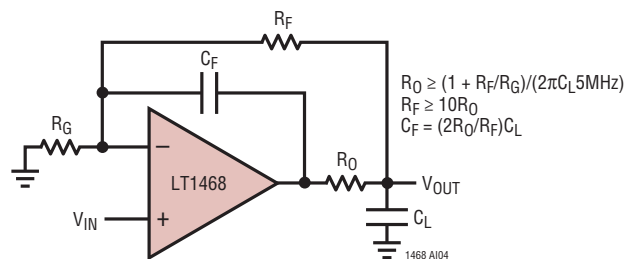

APPLICATIONS INFORMATION

The 150 μ V settling curve in the Typical Performance Characteristics is measured using the Differential Amplifier method of AN74 followed by a clamped, nonsaturating gain of 100. The total gain of 500 allows a resolution of 100 μ V/DIV with an oscilloscope setting of 0.05V/DIV

The settling of the DAC I-to-V converter on the front page was measured using the exact methods of AN74. The optimum nulling of the DAC output capacitance requires 20pF across the 6k feedback resistor. The theoretical limit for 16-bit settling is 11.1 times this RC time constant or 1.33 μ s. The actual settling time is 1.7 μ s at the output of the LT1468. The LT1468 is the fastest Linear Technology amplifier in this application.

The optional noise filter adds a slight delay of 100ns, but reduces the noise bandwidth to 1.6MHz which increases the output resolution for 16-bit accuracy.

Distortion

The LT1468 has outstanding distortion performance as shown in the Typical Performance curves of Total Harmonic Distortion + Noise vs Frequency and Amplitude. The high open-loop gain and inherently balanced architecture reduce errors to yield 16-bit accuracy to frequencies as high as 100kHz. An example of this performance is the Typical Application titled 100kHz Low Distortion Bandpass Filter. This circuit is useful for cleaning up the output of a high performance signal generator such as the B & K type 1051 or HP3326A.

Another key application for LT1468 is buffering the input to a 16-bit A/D converter. In a gain of 1 or 2 this straightforward circuit provides uncorrupted AC and DC levels to the converter, while buffering the A/D input sample-and-hold circuit from high source impedance which can reduce the maximum sampling rate. The front page graph shows better than 16-bit distortion for a gain of 2 with a 10V_{P-P} output.

SIMPLIFIED SCHEMATIC

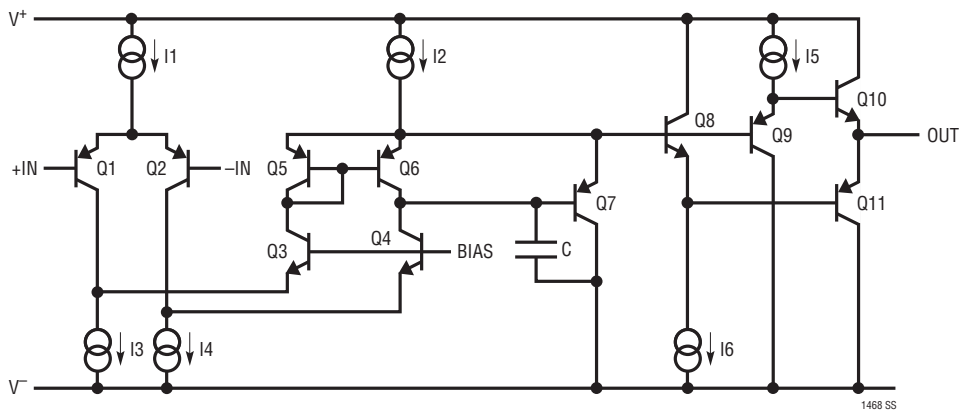

PACKAGE DESCRIPTION

DD Package
8-Lead Plastic DFN (3mm × 3mm)
 (Reference LTC DWG # 05-08-1698 Rev C)

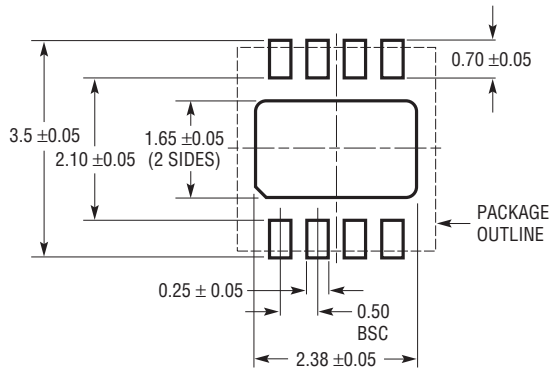

RECOMMENDED SOLDER PAD PITCH AND DIMENSIONS
 APPLY SOLDER MASK TO AREAS THAT ARE NOT SOLDERED

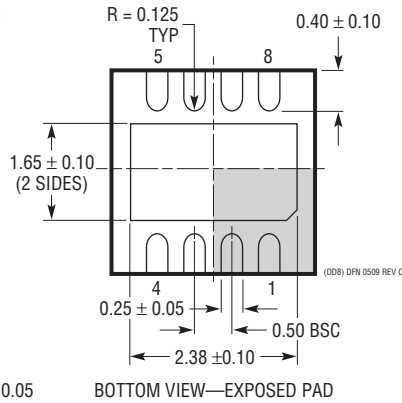
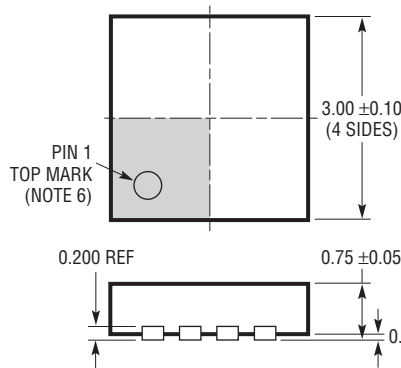

- NOTE:
1. DRAWING TO BE MADE A JEDEC PACKAGE OUTLINE M0-229 VARIATION OF (WEED-1)
 2. DRAWING NOT TO SCALE
 3. ALL DIMENSIONS ARE IN MILLIMETERS
 4. DIMENSIONS OF EXPOSED PAD ON BOTTOM OF PACKAGE DO NOT INCLUDE MOLD FLASH. MOLD FLASH, IF PRESENT, SHALL NOT EXCEED 0.15mm ON ANY SIDE
 5. EXPOSED PAD SHALL BE SOLDER PLATED
 6. SHADED AREA IS ONLY A REFERENCE FOR PIN 1 LOCATION ON TOP AND BOTTOM OF PACKAGE

PACKAGE DESCRIPTION

N8 Package
8-Lead PDIP (Narrow 0.300)
 (LTC DWG # 05-08-1510)

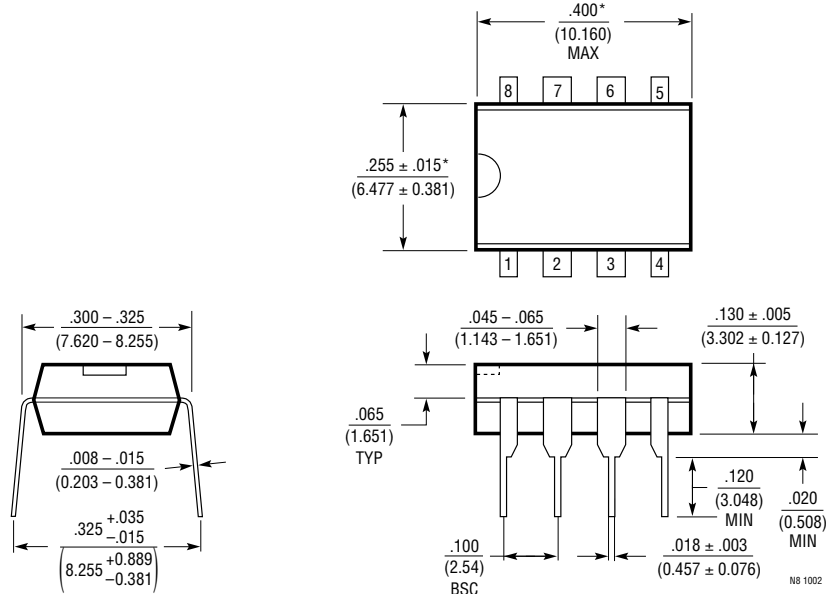

NOTE:
 1. DIMENSIONS ARE $\frac{\text{INCHES}}{\text{MILLIMETERS}}$
 *THESE DIMENSIONS DO NOT INCLUDE MOLD FLASH OR PROTRUSIONS.
 MOLD FLASH OR PROTRUSIONS SHALL NOT EXCEED .010 INCH (0.254mm)

S8 Package
8-Lead Plastic Small Outline (Narrow 0.150)
 (LTC DWG # 05-08-1610)

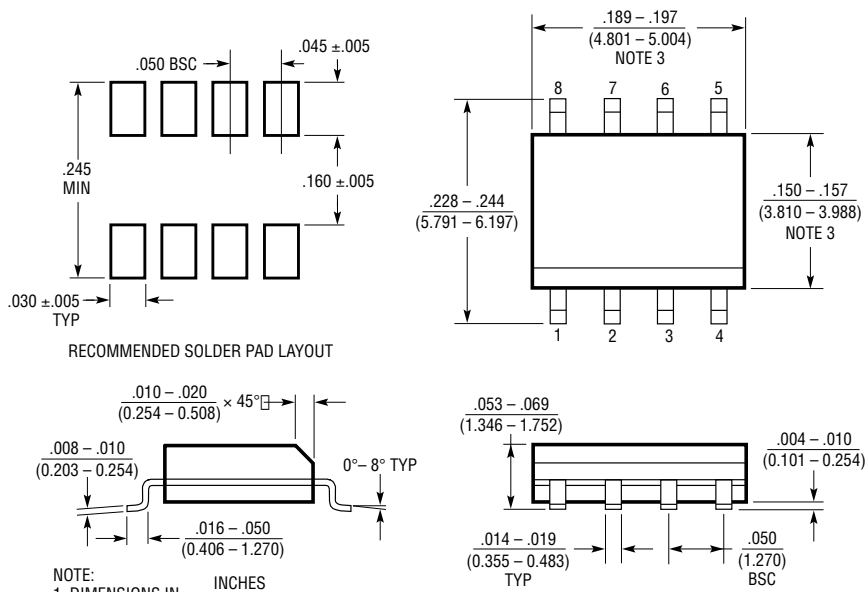

NOTE:
 1. DIMENSIONS IN $\frac{\text{INCHES}}{\text{MILLIMETERS}}$
 2. DRAWING NOT TO SCALE
 3. THESE DIMENSIONS DO NOT INCLUDE MOLD FLASH OR PROTRUSIONS.
 MOLD FLASH OR PROTRUSIONS SHALL NOT EXCEED .006" (0.15mm)

REVISION HISTORY (Revision history begins at Rev B)

REV	DATE	DESCRIPTION	PAGE NUMBER
B	10/09	Change to Both Packages in Pin Configuration	2