

1.5 μ A Max, Single, Dual and Quad Over-The-Top Precision Rail-to-Rail Input and Output Op Amps

FEATURES

- Low Supply Current: 1.5 μ A Max
- Rail-to-Rail Input and Output
- Low Offset Voltage: 375 μ V Max
- Operating Temperature Range: -40°C to 125°C
- Over-The-Top™ Inputs Operate Above V⁺
- Wide Supply Range: 2.2V to 36V
- Single Supply Input Range: -0.3V to 36V
- Low Input Bias Current: 250pA
- Low Input Offset Current: 20pA
- High A_{VOL}: 100V/mV Minimum Driving 100k Ω Load
- Output Sources and Sinks 500 μ A Load Current
- Reverse Battery Protected to 18V

APPLICATIONS

- Battery- or Solar-Powered Systems
- Portable Instrumentation
- Remote Sensor Amplifier
- Micropower Filter

LT, LTC and LT are registered trademarks of Linear Technology Corporation. Over-The-Top is a trademark of Linear Technology Corporation.

DESCRIPTION

The LT[®]1494/LT1495/LT1496 are the lowest power ($I_S \leq 1.5\mu\text{A}$) op amps with precision specifications. The extremely low supply current is combined with excellent amplifier specifications: input offset voltage is 375 μV maximum with a typical drift of only 0.4 $\mu\text{V}/^\circ\text{C}$, input offset current is 100pA maximum. A minimum open-loop gain (A_{VOL}) of 100V/mV ensures that gain errors are small. The device characteristics change little over the supply range of 2.2V to $\pm 15\text{V}$. Supply rejection is 90dB and the common mode rejection ratio is 90dB. Operation is specified for 3V, 5V and $\pm 15\text{V}$ supplies. Reverse battery protection (-18V min) and inputs that operate above the positive supply make the LT1494/LT1495/LT1496 easy to use in harsh environments.

The low bias currents and offset current of the amplifier permit the use of megohm level source resistors without introducing significant errors. Voltage noise at 4 $\mu\text{V}_{\text{P-P}}$ is remarkably low considering the low supply current.

The LT1494 is available in the 8-Pin MSOP, PDIP and SO packages. The LT1495 is available in plastic 8-Pin PDIP and SO packages with the standard dual op amp pinout. The LT1496 is available in 14-Pin SO and PDIP packages.

TYPICAL APPLICATION

Micropower Integrating Current Sense

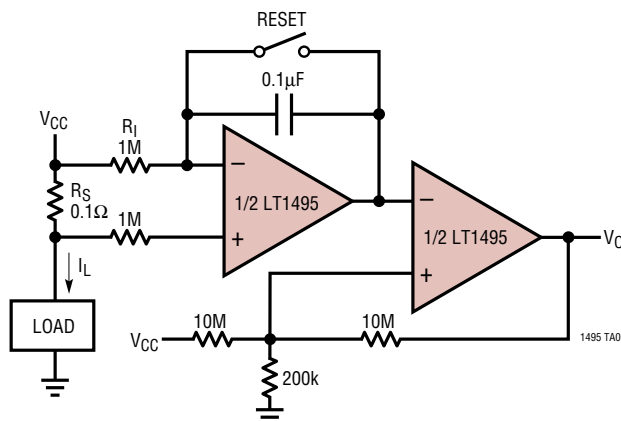

OUTPUT SWITCHES
 WHEN $\int i_L dt = 0.98 V_{CC} \left(\frac{R_1}{R_S} \right) C = (4.9A)(\text{SEC})$ FOR $V_{CC} = 5\text{V}$
 $I_S = 3\mu\text{A}$ DURING INTEGRATION; $I_S = 5\mu\text{A}$ END OF INTEGRATION

TC V_{OS} Distribution



1495 TA02

LT1494/LT1495/LT1496

ABSOLUTE MAXIMUM RATINGS (Note 1)

Total Supply Voltage (V^+ to V^-)	36V
Differential Input Voltage	36V
Input Current	$\pm 10\text{mA}$
Output Short-Circuit Duration	Continuous
Operating Temperature Range (Note 2)	
LT1494C/LT1495C/LT1496C	-40°C to 85°C
LT1494I/LT1495I/LT1496I	-40°C to 85°C
LT1494H/LT1495H/LT1496H	-40°C to 125°C

Specified Temperature Range (Note 3)	
LT1494C/LT1495C/LT1496C	-40°C to 85°C
LT1494I/LT1495I/LT1496I	-40°C to 85°C
LT1494H/LT1495H/LT1496H	-40°C to 125°C
Storage Temperature Range	-65°C to 150°C
Junction Temperature	150°C
Lead Temperature (Soldering, 10 sec)	300°C

PACKAGE/ORDER INFORMATION

 <p>MS8 PACKAGE 8-LEAD PLASTIC MSOP</p> <p>$T_{JMAX} = 150^\circ\text{C}$, $\theta_{JA} = 250^\circ\text{C/W}$</p>	ORDER PART NUMBER	 <p>N8 PACKAGE 8-LEAD PDIP S8 PACKAGE 8-LEAD PLASTIC SO</p> <p>$T_{JMAX} = 150^\circ\text{C}$, $\theta_{JA} = 130^\circ\text{C/W}$ (N8) $T_{JMAX} = 150^\circ\text{C}$, $\theta_{JA} = 190^\circ\text{C/W}$ (S8)</p>	ORDER PART NUMBER
	LT1494CMS8 LT1494IMS8		LT1494CN8 LT1494CS8 LT1494IN8 LT1494IS8 LT1494HS8
	MS8 PART MARKING		S8 PART MARKING
	LTFF LTFG		1494 1494I 1494H
 <p>N8 PACKAGE 8-LEAD PDIP S8 PACKAGE 8-LEAD PLASTIC SO</p> <p>$T_{JMAX} = 150^\circ\text{C}$, $\theta_{JA} = 130^\circ\text{C/W}$ (N8) $T_{JMAX} = 150^\circ\text{C}$, $\theta_{JA} = 190^\circ\text{C/W}$ (S8)</p>	ORDER PART NUMBER	 <p>N PACKAGE 14-LEAD PDIP S PACKAGE 14-LEAD PLASTIC SO</p> <p>$T_{JMAX} = 150^\circ\text{C}$, $\theta_{JA} = 130^\circ\text{C/W}$ (N) $T_{JMAX} = 150^\circ\text{C}$, $\theta_{JA} = 160^\circ\text{C/W}$ (S)</p>	ORDER PART NUMBER
	LT1495CN8 LT1495CS8 LT1495IN8 LT1495IS8 LT1495HS8		LT1496CN LT1496CS LT1496IN LT1496IS LT1496HS
	S8 PART MARKING		
	1495 1495I 1495H		

Consult LTC Marketing for parts specified with wider operating temperature ranges.

ELECTRICAL CHARACTERISTICS

$T_A = 25^\circ\text{C}$, $V_S = 5\text{V}$, 0V ; $V_S = 3\text{V}$, 0V ; $V_{CM} = V_O = \text{half supply}$, unless otherwise noted.

SYMBOL	PARAMETER	CONDITIONS	MIN	TYP	MAX	UNITS
V_{OS}	Input Offset Voltage	$V_S = 5\text{V}$		150	375	μV
		$V_S = 3\text{V}$		200	475	μV
		$V_S = 5\text{V}$, MS8 Package		150	475	μV
		$V_S = 3\text{V}$, MS8 Package		200	575	μV
I_B	Input Bias Current	(Note 5)		250	1000	pA
		$V_{CM} = 10\text{V}$ (Note 6)		180	360	nA
I_{OS}	Input Offset Current	(Note 5)		20	100	pA
	Input Noise Voltage	0.1Hz to 10Hz		4		μV_{p-p}
e_n	Input Noise Voltage Density	$f = 100\text{Hz}$		185		$\text{nV}/\sqrt{\text{Hz}}$
i_n	Input Noise Current Density	$f = 100\text{Hz}$		10		$\text{fA}/\sqrt{\text{Hz}}$
A_{VOL}	Large-Signal Voltage Gain	$V_S = 5\text{V}$, $V_O = 0.25\text{V}$ to 4.5V , $R_L = 100\text{k}$	100	500		V/mV
		$V_S = 3\text{V}$, $V_O = 0.25\text{V}$ to 2.5V , $R_L = 100\text{k}$	50	250		V/mV
	Input Voltage Range		0		36	V
CMRR	Common Mode Rejection Ratio	$V_{CM} = 0\text{V}$ to 4V , $V_S = 5\text{V}$	90	106		dB
		$V_{CM} = 0\text{V}$ to 10V , $V_S = 5\text{V}$	74	95		dB
PSRR	Power Supply Rejection Ratio	$V_S = 2.2\text{V}$ to 12V , $V_{CM} = V_O = 0.5\text{V}$	90	99		dB
	Minimum Operating Supply Voltage			2.1	2.2	V
V_{OL}	Output Voltage Swing LOW	No Load		50	100	mV
		$I_{SINK} = 100\mu\text{A}$		210	410	mV
V_{OH}	Output Voltage Swing HIGH	No Load	$V^+ - 0.07$	$V^+ - 0.035$		V
		$I_{SOURCE} = 100\mu\text{A}$	$V^+ - 0.32$	$V^+ - 0.160$		V
I_{SC}	Short-Circuit Current	(Note 5)	0.7	1.3		mA
I_S	Supply Current per Amplifier	(Note 6)		1.0	1.5	μA
	Reverse Supply Voltage	$I_S = 10\mu\text{A}$ per Amplifier	-18			V
SR	Slew Rate	$A_V = -1$, $V_S = \pm 5\text{V}$	0.4	1.0		V/ms
GBW	Gain Bandwidth Product	$f = 100\text{Hz}$		2.7		kHz

ELECTRICAL CHARACTERISTICS

The ● denotes the specifications which apply over the temperature range of $0^{\circ}\text{C} \leq T_A \leq 70^{\circ}\text{C}$, $V_S = 5\text{V}, 0\text{V}$; $V_S = 3\text{V}, 0\text{V}$; $V_{CM} = V_O = \text{half supply}$, unless otherwise noted. (Note 3)

SYMBOL	PARAMETER	CONDITIONS		MIN	TYP	MAX	UNITS
V_{OS}	Input Offset Voltage	$V_S = 5\text{V}$	●		175	425	μV
		$V_S = 3\text{V}$	●		225	525	μV
		$V_S = 5\text{V}, \text{MS8 Package}$	●		175	525	μV
		$V_S = 3\text{V}, \text{MS8 Package}$	●		225	625	μV
$V_{OS\ TC}$	Input Offset Voltage Drift	(Note 4)	●		0.4	2	$\mu\text{V}/^{\circ}\text{C}$
I_B	Input Bias Current	(Note 5)	●		250	1200	pA
		$V_{CM} = 10\text{V}$ (Note 6)	●		240	500	nA
I_{OS}	Input Offset Current	(Note 5)	●		20	120	pA
A_{VOL}	Large-Signal Voltage Gain	$V_S = 5\text{V}, V_O = 0.25\text{V to } 4.5\text{V}, R_L = 100\text{k}$	●	75	280		V/mV
		$V_S = 3\text{V}, V_O = 0.25\text{V to } 2.5\text{V}, R_L = 100\text{k}$	●	40	150		V/mV
	Input Voltage Range		●	0.2		36	V
CMRR	Common Mode Rejection Ratio	$V_{CM} = 0.2\text{V to } 4\text{V}, V_S = 5\text{V}$	●	89	106		dB
		$V_{CM} = 0.2\text{V to } 10\text{V}, V_S = 5\text{V}$	●	64	85		dB
PSRR	Power Supply Rejection Ratio	$V_S = 2.4\text{V to } 12\text{V}, V_{CM} = V_O = 0.5\text{V}$	●	89	99		dB
	Minimum Operating Supply Voltage		●		2.3	2.4	V
V_{OL}	Output Voltage Swing LOW	No Load	●		55	110	mV
		$I_{SINK} = 100\mu\text{A}$	●		225	450	mV
V_{OH}	Output Voltage Swing HIGH	No Load	●	$V^+ - 0.08$	$V^+ - 0.04$		V
		$I_{SOURCE} = 100\mu\text{A}$	●	$V^+ - 0.36$	$V^+ - 0.18$		V
I_{SC}	Short-Circuit Current	(Note 5)	●	0.6	1.1		mA
I_S	Supply Current per Amplifier	(Note 6)	●		1.2	1.8	μA

The ● denotes the specifications which apply over the temperature range of $-40^{\circ}\text{C} \leq T_A \leq 85^{\circ}\text{C}$, $V_S = 5\text{V}, 0\text{V}$; $V_S = 3\text{V}, 0\text{V}$; $V_{CM} = V_O = \text{half supply}$, unless otherwise noted. (Note 3)

SYMBOL	PARAMETER	CONDITIONS		MIN	TYP	MAX	UNITS
V_{OS}	Input Offset Voltage	$V_S = 5\text{V}$	●		200	475	μV
		$V_S = 3\text{V}$	●		250	575	μV
		$V_S = 5\text{V}, \text{MS8 Package}$	●		200	575	μV
		$V_S = 3\text{V}, \text{MS8 Package}$	●		250	675	μV
$V_{OS\ TC}$	Input Offset Voltage Drift	(Note 4)	●		0.4	2	$\mu\text{V}/^{\circ}\text{C}$
I_B	Input Bias Current	(Note 5)	●		250	1700	pA
		$V_{CM} = 10\text{V}$ (Note 6)	●		275		nA
I_{OS}	Input Offset Current	(Note 5)	●		20	170	pA
A_{VOL}	Large-Signal Voltage Gain	$V_S = 5\text{V}, V_O = 0.25\text{V to } 4.5\text{V}, R_L = 100\text{k}$	●	55	215		V/mV
		$V_S = 3\text{V}, V_O = 0.25\text{V to } 2.5\text{V}, R_L = 100\text{k}$	●	30	115		V/mV
	Input Voltage Range		●	0.2		36	V
CMRR	Common Mode Rejection Ratio	$V_{CM} = 0.2\text{V to } 4\text{V}, V_S = 5\text{V}$	●	88	106		dB
		$V_{CM} = 0.2\text{V to } 10\text{V}, V_S = 5\text{V}$	●		75		dB
PSRR	Power Supply Rejection Ratio	$V_S = 2.7\text{V to } 12\text{V}, V_{CM} = V_O = 0.5\text{V}$	●	88	99		dB
	Minimum Operating Supply Voltage		●		2.6	2.7	V
V_{OL}	Output Voltage Swing LOW	No Load	●		60	120	mV
		$I_{SINK} = 100\mu\text{A}$	●		245	490	mV
V_{OH}	Output Voltage Swing HIGH	No Load	●	$V^+ - 0.10$	$V^+ - 0.05$		mV
		$I_{SOURCE} = 100\mu\text{A}$	●	$V^+ - 0.38$	$V^+ - 0.19$		mV
I_{SC}	Short-Circuit Current	(Note 5)	●	0.4	0.9		mA
I_S	Supply Current per Amplifier	(Note 6)	●		1.5	2.3	μA

ELECTRICAL CHARACTERISTICS

The ● denotes the specifications which apply over the temperature range of $-40^{\circ}\text{C} \leq T_A \leq 125^{\circ}\text{C}$. $V_S = 5\text{V}, 0\text{V}$; $V_S = 3\text{V}, 0\text{V}$; $V_{\text{CM}} = V_O =$ half supply, unless otherwise noted. (Note 3)

SYMBOL	PARAMETER	CONDITIONS	LT1494H/LT1495H/LT1496H			UNITS
			MIN	TYP	MAX	
V_{OS}	Input Offset Voltage	$V_S = 5\text{V}$	●	225	875	μV
		$V_S = 3\text{V}$	●	275	975	μV
$V_{\text{OS TC}}$	Input Offset Voltage Drift	(Note 4)	●	0.4	3	$\mu\text{V}/^{\circ}\text{C}$
I_B	Input Bias Current	(Note 5)	●	3.8	10	nA
		$V_{\text{CM}} = 10\text{V}$ (Note 6)	●	0.300	2	μA
I_{OS}	Input Offset Current	(Note 5)	●	0.3	2	nA
A_{VOL}	Large-Signal Voltage Gain	$V_S = 5\text{V}, V_O = 0.25\text{V to } 4.5\text{V}, R_L = 100\text{k}$	●	4	25	V/mV
		$V_S = 3\text{V}, V_O = 0.25\text{V to } 2.5\text{V}, R_L = 100\text{k}$	●	2	17	V/mV
	Input Voltage Range		●	0.5	36	V
CMRR	Common Mode Rejection Ratio	$V_{\text{CM}} = 0.5\text{V to } 4\text{V}, V_S = 5\text{V}$	●	72	95	dB
		$V_{\text{CM}} = 0.5\text{V to } 10\text{V}, V_S = 5\text{V}$	●		85	dB
PSRR	Power Supply Rejection Ratio	$V_S = 2.7\text{V to } 12\text{V}, V_{\text{CM}} = V_O = 0.5\text{V}$	●	86	105	dB
		Minimum Operating Supply Voltage	●		2.7	V
V_{OL}	Output Voltage Swing LOW	No Load	●	70	160	mV
		$I_{\text{SINK}} = 100\mu\text{A}$	●	275	550	mV
V_{OH}	Output Voltage Swing HIGH	No Load	●	$V^+ - 140$	$V^+ - 45$	mV
		$I_{\text{SOURCE}} = 100\mu\text{A}$	●	$V^+ - 450$	$V^+ - 225$	mV
I_S	Supply Current per Amplifier	(Note 6)	●	2	5	μA

$T_A = 25^{\circ}\text{C}$, $V_S = \pm 15\text{V}$, $V_{\text{CM}} = V_O = 0\text{V}$, unless otherwise noted.

SYMBOL	PARAMETER	CONDITIONS	MIN	TYP	MAX	UNITS
V_{OS}	Input Offset Voltage			200	575	μV
		MS8 Package		200	675	μV
I_B	Input Bias Current			25	1000	pA
I_{OS}	Input Offset Current			20	100	pA
A_{VOL}	Large-Signal Voltage Gain	$V_O = \pm 10\text{V}, R_L = 100\text{k}$	100	360		V/mV
		Input Voltage Range	-15		21	V
CMRR	Common Mode Rejection Ratio	$V_{\text{CM}} = -15\text{V to } 14\text{V}$	100	120		dB
PSRR	Power Supply Rejection Ratio	$V_S = \pm 5\text{V to } \pm 15\text{V}$	96	120		dB
V_{OL}	Output Voltage Swing LOW	$R_L = 1\text{M}$		-14.85	-14.70	V
		$R_L = 100\text{k}$		-14.75	-14.50	V
V_{OH}	Output Voltage Swing HIGH	$R_L = 1\text{M}$	14.78	14.89		V
		$R_L = 100\text{k}$	14.62	14.81		V
I_{SC}	Short-Circuit Current		0.7	1.5		mA
I_S	Supply Current per Amplifier			1.4	2.0	μA

ELECTRICAL CHARACTERISTICS

The ● denotes the specifications which apply over the temperature range of $0^{\circ}\text{C} \leq T_A \leq 70^{\circ}\text{C}$, $V_S = \pm 15\text{V}$, $V_{CM} = V_O = 0\text{V}$, unless otherwise noted. (Note 3)

SYMBOL	PARAMETER	CONDITIONS		MIN	TYP	MAX	UNITS
V_{OS}	Input Offset Voltage		●		225	625	μV
		MS8 Package	●		225	725	μV
I_B	Input Bias Current		●		250	1200	pA
I_{OS}	Input Offset Current		●		20	120	pA
A_{VOL}	Large-Signal Voltage Gain	$V_O = \pm 10\text{V}$, $R_L = 100\text{k}$	●	60	240		V/mV
		Input Voltage Range	●	-14.8		21	V
CMRR	Common Mode Rejection Ratio	$V_{CM} = -14.8\text{V}$ to 14V	●	98	120		dB
PSRR	Power Supply Rejection Ratio	$V_S = \pm 5\text{V}$ to $\pm 15\text{V}$	●	94	120		dB
V_{OL}	Output Voltage Swing LOW	$R_L = 1\text{M}$	●		-14.84	-14.67	V
		$R_L = 100\text{k}$	●		-14.73	-14.46	V
V_{OH}	Output Voltage Swing HIGH	$R_L = 1\text{M}$	●	14.76	14.88		V
		$R_L = 100\text{k}$	●	14.58	14.79		V
I_{SC}	Short-Circuit Current		●	0.6	1.3		mA
I_S	Supply Current per Amplifier		●		1.6	2.4	μA

The ● denotes the specifications which apply over the temperature range of $-40^{\circ}\text{C} \leq T_A \leq 85^{\circ}\text{C}$, $V_S = \pm 15\text{V}$, $V_{CM} = V_O = 0\text{V}$, unless otherwise noted. (Note 3)

SYMBOL	PARAMETER	CONDITIONS		MIN	TYP	MAX	UNITS
V_{OS}	Input Offset Voltage		●		250	675	μV
		MS8 Package	●		250	775	μV
I_B	Input Bias Current		●		250	1700	pA
I_{OS}	Input Offset Current		●		20	170	pA
A_{VOL}	Large-Signal Voltage Gain	$V_O = \pm 10\text{V}$, $R_L = 100\text{k}$	●	50	200		V/mV
		Input Voltage Range	●	-14.8		21	V
CMRR	Common Mode Rejection Ratio	$V_{CM} = -14.8\text{V}$ to 14V	●	96	114		dB
PSRR	Power Supply Rejection Ratio	$V_S = \pm 5\text{V}$ to $\pm 15\text{V}$	●	92	120		dB
V_{OL}	Output Voltage Swing LOW	$R_L = 1\text{M}$	●		-14.83	-14.66	V
		$R_L = 100\text{k}$	●		-14.72	-14.44	V
V_{OH}	Output Voltage Swing HIGH	$R_L = 1\text{M}$	●	14.74	14.87		V
		$R_L = 100\text{k}$	●	14.54	14.77		V
I_{SC}	Short-Circuit Current		●	0.4	1.1		mA
I_S	Supply Current per Amplifier		●		2.0	3.0	μA

ELECTRICAL CHARACTERISTICS

The ● denotes the specifications which apply over the temperature range of $-40^{\circ}\text{C} \leq T_A \leq 125^{\circ}\text{C}$. $V_S = \pm 15\text{V}$, $V_{CM} = V_O = \text{half supply}$, unless otherwise noted. (Note 3)

SYMBOL	PARAMETER	CONDITIONS	LT1494H/LT1495H/LT1496H			UNITS
			MIN	TYP	MAX	
V_{OS}	Input Offset Voltage		●	275	1100	μV
I_B	Input Bias Current		●	3.8	10	nA
I_{OS}	Input Offset Current		●	0.3	2	nA
A_{VOL}	Large-Signal Voltage Gain	$V_O = \pm 10\text{V}$, $R_L = 100\text{k}$	●	21	70	V/mV
	Input Voltage Range		●	-14.5	21	V
CMRR	Common Mode Rejection Ratio	$V_{CM} = -14.5\text{V}$ to 14V	●	69	90	dB
PSRR	Power Supply Rejection Ratio	$V_S = \pm 5\text{V}$ to $\pm 15\text{V}$	●	89	115	dB
V_{OL}	Output Voltage Swing LOW	$R_L = 1\text{M}$ $R_L = 100\text{k}$	●	-14.80	-14.4	V
			●	-14.69	-14.2	V
V_{OH}	Output Voltage Swing HIGH	$R_L = 1\text{M}$ $R_L = 100\text{k}$	●	14.5	14.85	V
			●	14.3	14.73	V
I_S	Supply Current per Amplifier		●	3	6	μA

Note 1: Absolute Maximum Ratings are those values beyond which the life of the device may be impaired.

Note 2: The LT1494C/LT1495C/LT1496C and LT1494I/LT1495I/LT1496I are guaranteed functional over the operating temperature range of -40°C to 85°C . The LT1494H/LT1495H/LT1496H are guaranteed functional over the operating temperature range of -40°C to 125°C .

Note 3: The LT1494C/LT1495C/LT1496C are guaranteed to meet specified performance from 0°C to 70°C . The LT1494C/LT1495C/LT1496C are designed, characterized and expected to meet specified performance from

-40°C to 85°C but are not tested or QA sampled at these temperatures. The LT1494I/LT1495I/LT1496I are guaranteed to meet specified performance from -40°C to 85°C . The LT1494H/LT1495H/LT1496H are guaranteed to meet specified performance from -40°C to 125°C .

Note 4: This parameter is not 100% tested.

Note 5: $V_S = 5\text{V}$ limits are guaranteed by correlation to $V_S = 3\text{V}$ and $V_S = \pm 15\text{V}$ tests.

Note 6: $V_S = 3\text{V}$ limits are guaranteed by correlation to $V_S = 5\text{V}$ and $V_S = \pm 15\text{V}$ tests.

TYPICAL PERFORMANCE CHARACTERISTICS

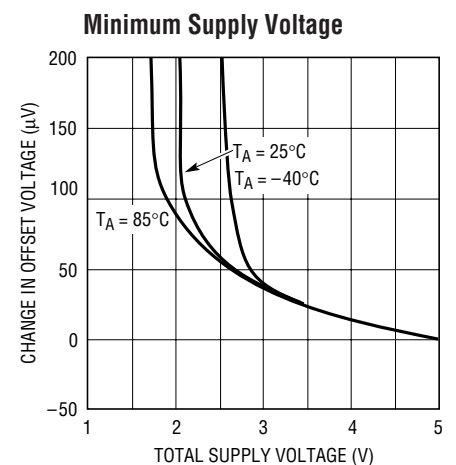
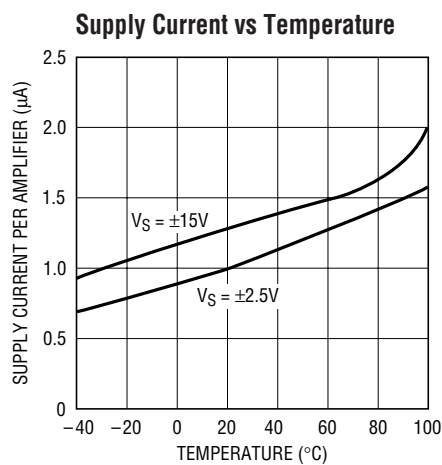
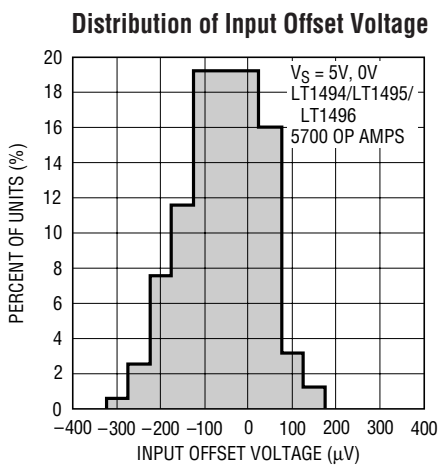

TYPICAL PERFORMANCE CHARACTERISTICS

Output Saturation Voltage vs Load Current (Output Low)

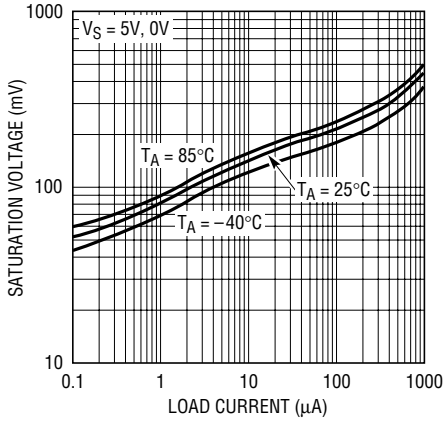

1495 G04

Output Saturation Voltage vs Load Current (Output High)

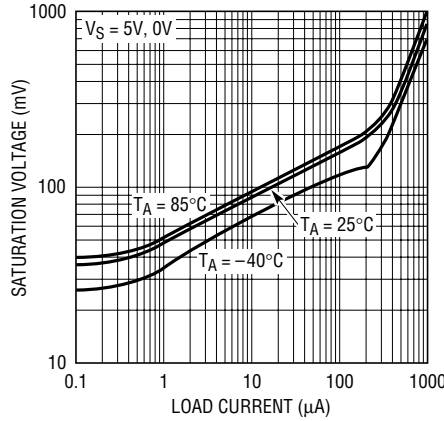

1495 G05

Input Bias Current vs Common Mode Voltage



1495 G06

Gain and Phase Shift vs Frequency



1495 G10

Noise Voltage Spectrum

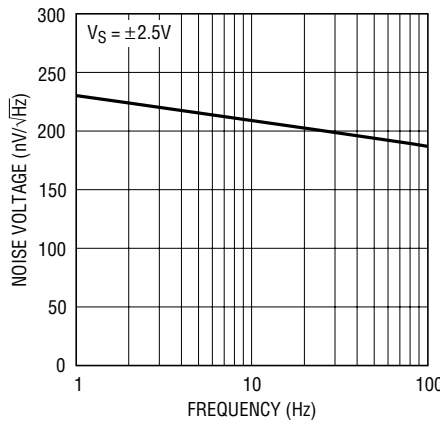

1495 G08

Noise Current Spectrum

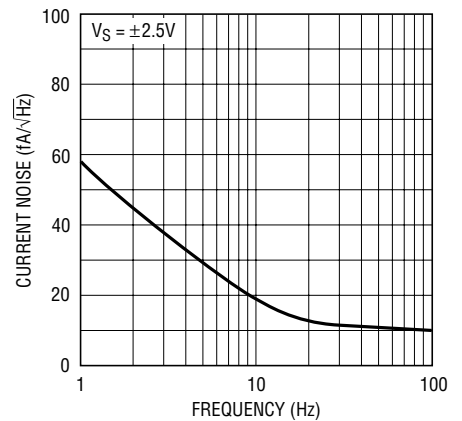

1495 G09

Gain Bandwidth and Phase Margin vs Supply Voltage

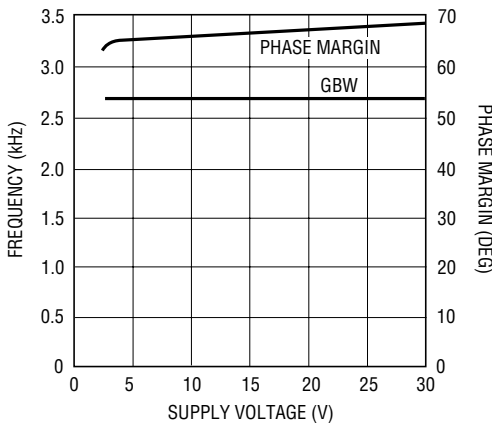

1495 G11

0.1Hz to 10Hz Output Voltage Noise

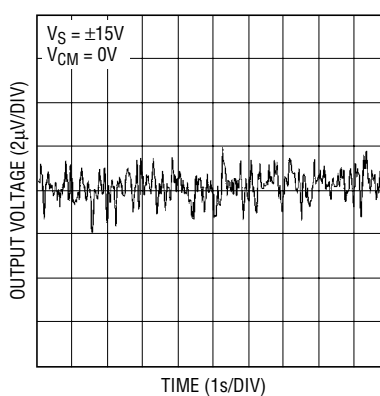

1495 G07

Capacitive Load Handling

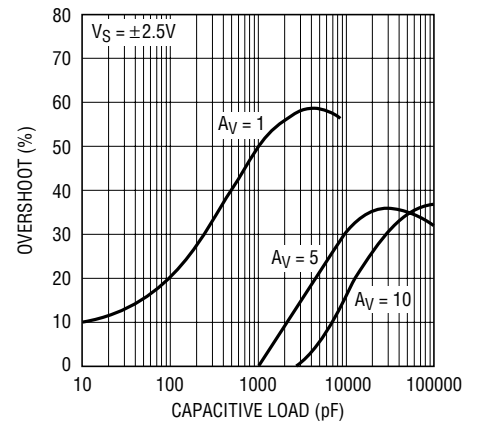

1495 G12

TYPICAL PERFORMANCE CHARACTERISTICS

Common Mode Rejection Ratio vs Frequency

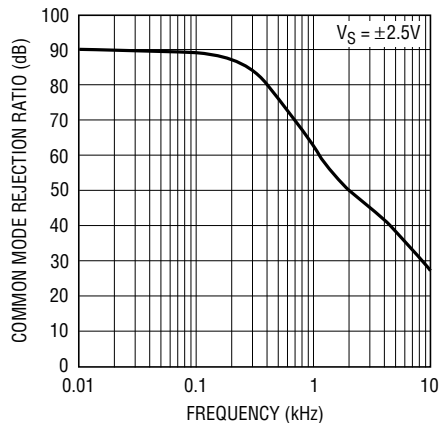

Power Supply Rejection Ratio vs Frequency

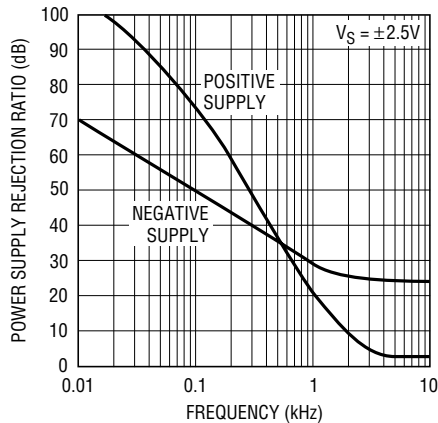

Output Impedance vs Frequency

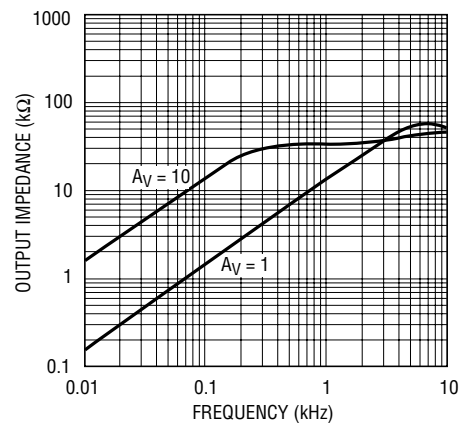

Warm-Up Drift vs Time

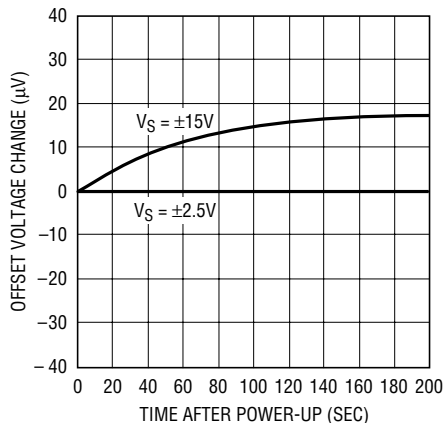

Open-Loop Gain VS = 5V, 0V

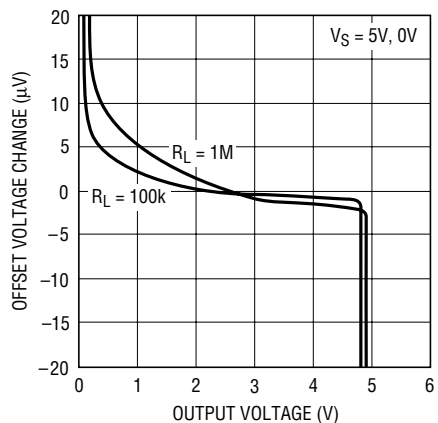

Open-Loop Gain VS = ±15V

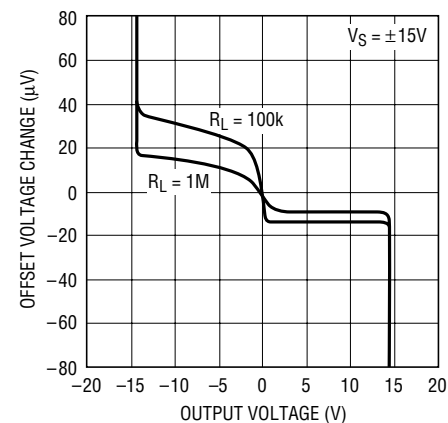

Small-Signal Response VS = ±15V



VS = ±15V
RL = 1M
CL = 100pF

Small-Signal Response VS = 5V, 0V

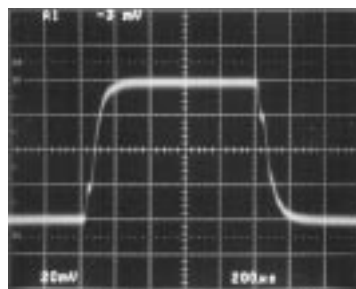

VS = 5V, 0V
RL = 1M
CL = 100pF

Large-Signal Response VS = 5V, 0V



VS = 5V, 0V
RL = 1M
CL = 100pF

APPLICATIONS INFORMATION

Start-Up Characteristics

Micropower op amps are sometimes not micropower during start-up, wreaking havoc on low current supplies. In the worst case, there may not be enough supply current available to take the system up to nominal voltages. Figure 1 is a graph of LT1495 supply current vs supply voltage for the three limit cases of input offset that could occur during start-up. The circuits are shown in Figure 2. One circuit creates a positive offset, forcing the output to come up saturated high. Another circuit creates a negative offset, forcing the output to come up saturated low, while the last brings up the output at half supply. In all cases, the supply current is well behaved. Supply current is highest with the output forced high, so if one amplifier is unused, it is best to force the output low or at half supply.

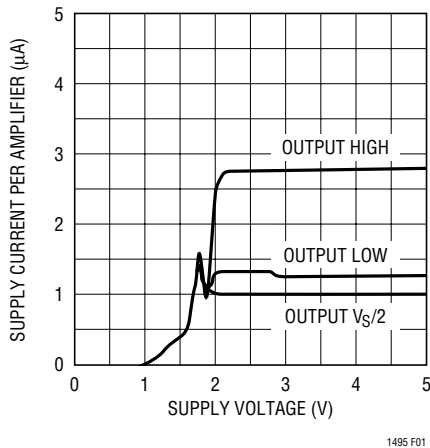

Figure 1. Start-Up Characteristics

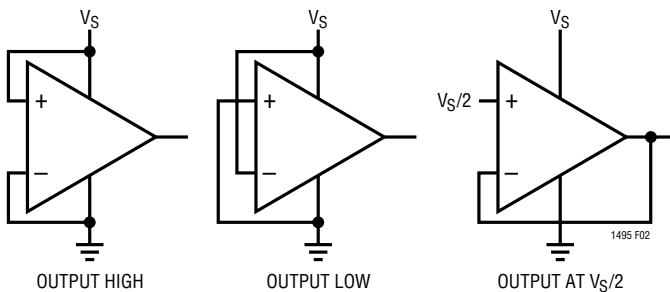

Figure 2. Circuits for Start-Up Characteristics

Reverse Battery

The LT1494/LT1495/LT1496 are protected against reverse battery voltages up to 18V. In the event a reverse battery condition occurs, the supply current is typically less than 100nA (inputs grounded and outputs open). For typical single supply applications with ground referred loads and feedback networks, no other precautions are required. If the reverse battery condition results in a negative voltage at either the input pins or output pin, the current into the pin should be limited by an external resistor to less than 10mA.

Inputs

While the LT1494/LT1495/LT1496 will function normally with its inputs taken above the positive supply, the common mode range does not extend beyond approximately 300mV below the negative supply at room temperature. The device will not be damaged if the inputs are taken lower than 300mV below the negative supply as long as the current out of the pin is limited to less than 10mA. However, the output phase is not guaranteed and the supply current will increase.

Output

The graph, Capacitive Load Handling, shows amplifier stability with the output biased at half supply. If the output is to be operated within about 100mV of the positive rail, the allowable load capacitance is less. With this output voltage, the worst case occurs at A_V = 1 and light loads, where the load capacitance should be less than 500pF with a 5V supply and less than 100pF with a 30V supply.

Rail-to-Rail Operation

The simplified schematic, Figure 3, details the circuit design approach of the LT1494/LT1495/LT1496. The amplifier topology is a three-stage design consisting of a rail-to-rail input stage, that continues to operate with the inputs above the positive rail, a folded cascode second stage that develops most of the voltage gain, and a rail-to-rail common emitter stage that provides the current gain.

APPLICATIONS INFORMATION



Figure 3. Simplified Schematic

The input stage is formed by two diff amps Q1-Q2 and Q3-Q6. For signals with a common mode voltage between V_{EE} and $(V_{CC} - 0.8V)$, Q1 and Q2 are active. When the input common mode exceeds $(V_{CC} - 0.8V)$, Q7 turns on, diverting the current from diff amp Q1-Q2 to current mirror Q8-Q9. The current from Q8 biases on the other diff amp consisting of PNP's Q5-Q6 and NPN's Q3-Q4. Though Q5-Q6 are driven from the emitters rather than the base, the basic diff amp action is the same. When the common mode voltage is between $(V_{CC} - 0.8V)$ and V_{CC} , devices Q3 and Q4 act as followers, forming a buffer between the amplifier inputs and the emitters of the Q5-Q6. If the common mode voltage is taken above V_{CC} , Schottky diodes D1 and D2 reverse bias and devices Q3 and Q4 then

act as diodes. The diff amp formed by Q5-Q6 operates normally, however, the input bias current increases to the emitter current of Q5-Q6, which is typically 180nA. The graph, Input Bias Current vs Common Mode Voltage found in the Typical Performance Characteristics section, shows these transitions at three temperatures.

The collector currents of the two-input pairs are combined in the second stage consisting of Q11 to Q16, which furnishes most of the voltage gain. Capacitor C1 sets the amplifier bandwidth. The output stage is configured for maximum swing by the use of common emitter output devices Q21 and Q22. Diodes D4 to D6 and current source Q15 set the output quiescent current.

TYPICAL APPLICATIONS

13µA, 0kHz to 10kHz Voltage to Frequency Converter



1495 TA07

6µA, $A_V = 1000$, Chopper Stabilized Amplifier

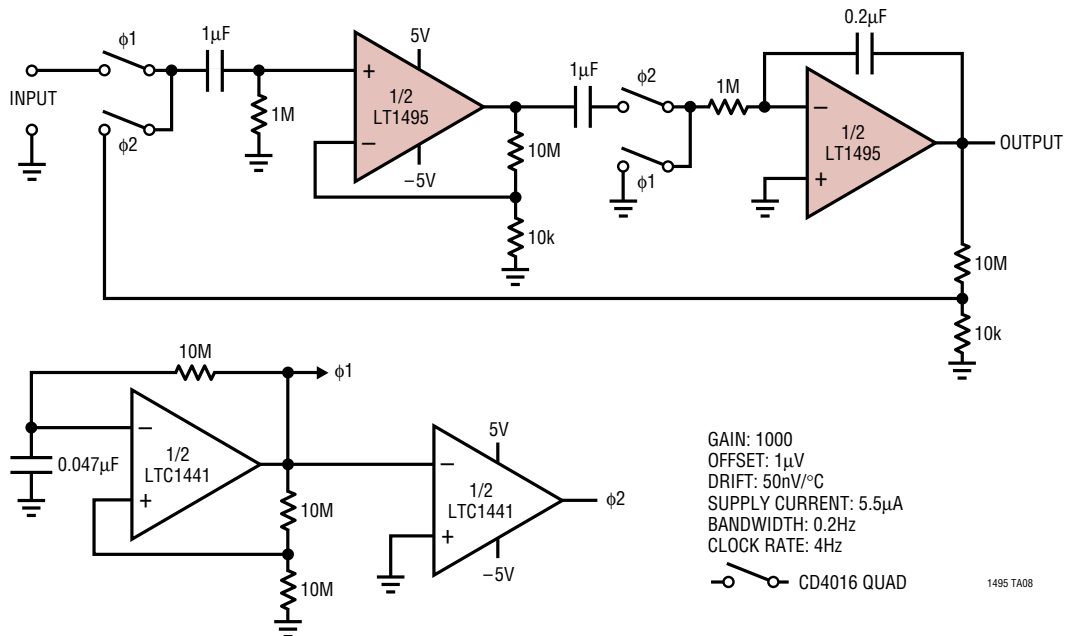

1495 TA08

TYPICAL APPLICATIONS

6th Order 10Hz Elliptic Lowpass Filter



Filter Frequency Response



PACKAGE DESCRIPTION

MS8 Package

8-Lead Plastic MSOP

(Reference LTC DWG # 05-08-1660)

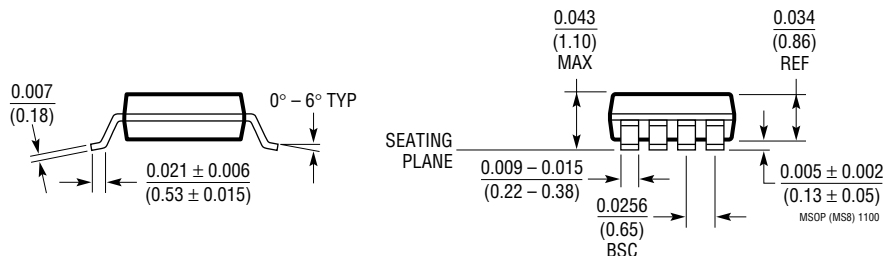

* DIMENSION DOES NOT INCLUDE MOLD FLASH, PROTRUSIONS OR GATE BURRS. MOLD FLASH, PROTRUSIONS OR GATE BURRS SHALL NOT EXCEED 0.006* (0.152mm) PER SIDE

** DIMENSION DOES NOT INCLUDE INTERLEAD FLASH OR PROTRUSIONS. INTERLEAD FLASH OR PROTRUSIONS SHALL NOT EXCEED 0.006* (0.152mm) PER SIDE

PACKAGE DESCRIPTION

N8 Package
8-Lead PDIP (Narrow .300 Inch)
 (Reference LTC DWG # 05-08-1510)



*THESE DIMENSIONS DO NOT INCLUDE MOLD FLASH OR PROTRUSIONS.
 MOLD FLASH OR PROTRUSIONS SHALL NOT EXCEED 0.010 INCH (0.254mm)

IN8 1098

S8 Package
8-Lead Plastic Small Outline (Narrow .150 Inch)
 (Reference LTC DWG # 05-08-1610)



DIMENSION DOES NOT INCLUDE MOLD FLASH. MOLD FLASH SHALL NOT EXCEED 0.006 (0.152mm) PER SIDE
 **DIMENSION DOES NOT INCLUDE INTERLEAD FLASH. INTERLEAD FLASH SHALL NOT EXCEED 0.010* (0.254mm) PER SIDE

PACKAGE DESCRIPTION

N Package
14-Lead PDIP (Narrow .300 Inch)
 (Reference LTC DWG # 05-08-1510)

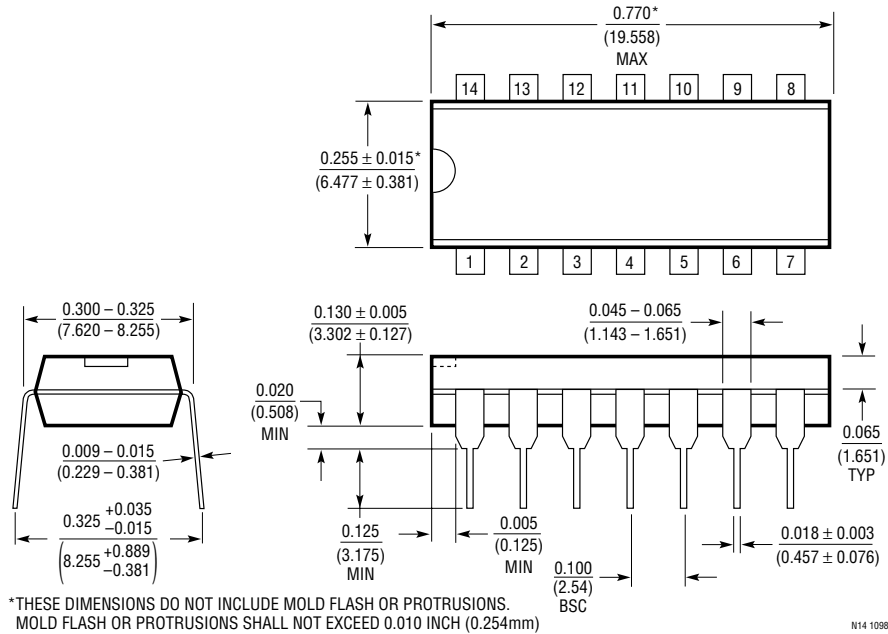

S Package
14-Lead Plastic Small Outline (Narrow .150 Inch)
 (Reference LTC DWG # 05-08-1610)

