

## FEATURES

- **Minimum Output Current:**  $\pm 125\text{mA}$
- **Maximum Supply Current per Amp:**  $7\text{mA}$ ,  $V_S = \pm 5\text{V}$
- **Bandwidth:**  $50\text{MHz}$ ,  $V_S = \pm 15\text{V}$
- **Slew Rate:**  $900\text{V}/\mu\text{s}$ ,  $V_S = \pm 15\text{V}$
- **Wide Supply Range:**  $V_S = \pm 2.5\text{V}$  to  $\pm 15\text{V}$   
(Enhanced  $\theta_{JA}$  16-Pin SO Package)
- **Enhanced  $\theta_{JA}$  SO-8 Package for  $\pm 5\text{V}$  Operation**
- **0.02% Differential Gain:**  $A_V = 2$ ,  $R_L = 150\Omega$
- **0.015° Differential Phase:**  $A_V = 2$ ,  $R_L = 150\Omega$
- **$\pm 13\text{V}$  Output Swing:**  $I_L = 100\text{mA}$ ,  $V_S = \pm 15\text{V}$
- **$\pm 3.1\text{V}$  Output Swing:**  $I_L = 100\text{mA}$ ,  $V_S = \pm 5\text{V}$
- **55ns Settling Time to 0.1%, 10V Step**
- **Thermal Shutdown Protection**

## APPLICATIONS

- Twisted-Pair Drivers
- Video Amplifiers
- Cable Drivers
- Test Equipment Amplifiers
- Buffers

## DESCRIPTION

The LT<sup>®</sup>1497 dual current feedback amplifier features low power, high output drive, excellent video characteristics and outstanding distortion performance. From a low 7mA maximum supply current per amplifier, the LT1497 drives  $\pm 100\text{mA}$  with only 1.9V of headroom. Twisted pairs can be driven differentially with  $-70\text{dBc}$  distortion up to 1MHz for  $\pm 40\text{mA}$  peak signals.

The LT1497 is available in a low thermal resistance 16-pin SO package for operation with supplies up to  $\pm 15\text{V}$ . For  $\pm 5\text{V}$  operation the device is also available in a low thermal resistance SO-8 package. The device has thermal and current limit circuits that protect against fault conditions.

The LT1497 is manufactured on Linear Technology's complementary bipolar process. The device has characteristics that bridge the performance between the LT1229 and LT1207 dual current feedback amplifiers. The LT1229 has 30mA output drive, 100MHz bandwidth and 12mA supply current. The LT1207 has 250mA output drive, 60MHz bandwidth and 40mA supply current.

LT, LTC and LT are registered trademarks of Linear Technology Corporation.

## TYPICAL APPLICATION

HDSL2 Single Pair Line Driver

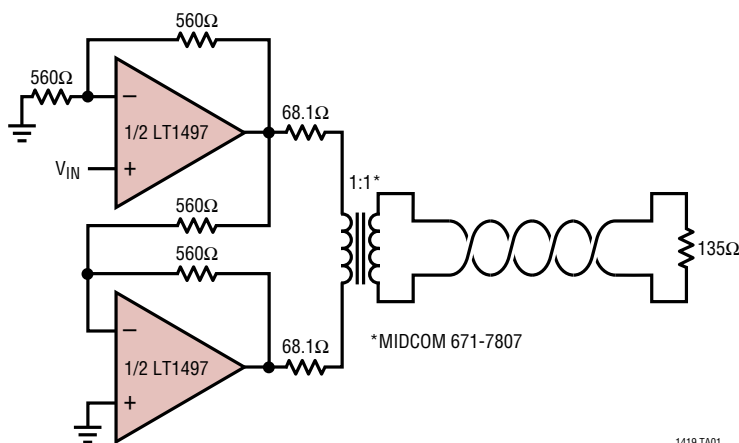

2nd and 3rd Harmonic Distortion of  
HDSL2 Single Pair Line Driver

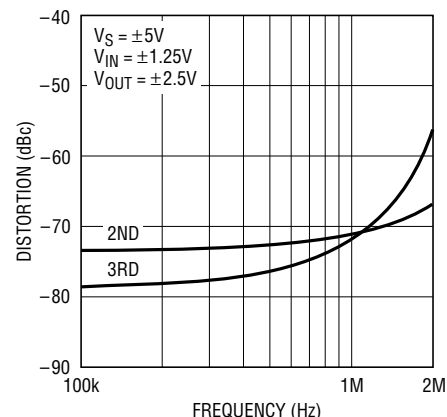

## ABSOLUTE MAXIMUM RATINGS

Total Supply Voltage ( $V^+$ to $V^-$ )	Operating Temperature Range (Note 2) ...	$-40^{\circ}\text{C}$ to $85^{\circ}\text{C}$
LT1497CS8 .....	Specified Temperature Range .....	$0^{\circ}\text{C}$ to $70^{\circ}\text{C}$
LT1497CS .....	Maximum Junction Temperature (See Below) .....	$150^{\circ}\text{C}$
Noninverting Input Current .....	Storage Temperature Range .....	$-65^{\circ}\text{C}$ to $150^{\circ}\text{C}$
Output Short-Circuit Duration (Note 1) .....	Lead Temperature (Soldering, 10 sec) .....	$300^{\circ}\text{C}$
		Continuous

## PACKAGE/ORDER INFORMATION

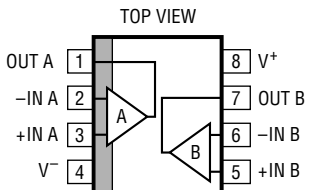
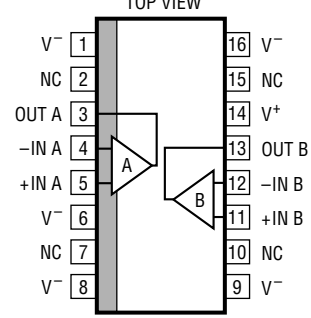
 <p>S8 PACKAGE 8-LEAD PLASTIC SO <math>T_{JMAX} = 150^{\circ}\text{C}</math>, <math>\theta_{JA} = 80^{\circ}\text{C}/\text{W}</math> (NOTE 3)</p>	ORDER PART NUMBER	 <p>S PACKAGE 16-LEAD PLASTIC SO <math>T_{JMAX} = 150^{\circ}\text{C}</math>, <math>\theta_{JA} = 40^{\circ}\text{C}/\text{W}</math> (NOTE 3)</p>	ORDER PART NUMBER
	LT1497CS8		LT1497CS
	S8 PART MARKING		
	1497		

Consult factory for Industrial and Military grade parts.

## ELECTRICAL CHARACTERISTICS

$V_{CM} = 0\text{V}$ ,  $\pm 2.5\text{V} \leq V_S \leq \pm 15\text{V}$  (LT1497CS),  $\pm 2.5\text{V} \leq V_S \leq \pm 5\text{V}$  (LT1497CS8), pulse tested unless otherwise noted.

SYMBOL	PARAMETER	CONDITIONS	MIN	TYP	MAX	UNITS
$V_{OS}$	Input Offset Voltage	$T_A = 25^{\circ}\text{C}$		$\pm 3$	$\pm 10$ $\pm 15$	mV mV
	Input Offset Voltage Matching	$T_A = 25^{\circ}\text{C}$		$\pm 1$	$\pm 3.5$ $\pm 5.0$	mV mV
	Input Offset Voltage Drift			10		$\mu\text{V}/^{\circ}\text{C}$
$I_{IN}^+$	Noninverting Input Current	$T_A = 25^{\circ}\text{C}$		$\pm 1$	$\pm 3$ $\pm 10$	$\mu\text{A}$ $\mu\text{A}$
	Noninverting Input Current Matching	$T_A = 25^{\circ}\text{C}$		$\pm 0.3$	$\pm 1.0$ $\pm 1.5$	$\mu\text{A}$ $\mu\text{A}$
$I_{IN}^-$	Inverting Input Current	$T_A = 25^{\circ}\text{C}$		$\pm 7$	$\pm 20$ $\pm 40$	$\mu\text{A}$ $\mu\text{A}$
	Inverting Input Current Matching	$T_A = 25^{\circ}\text{C}$		$\pm 3$	$\pm 10$ $\pm 15$	$\mu\text{A}$ $\mu\text{A}$
$e_n$	Input Noise Voltage Density	$f = 1\text{kHz}$ , $R_F = 1\text{k}$ , $R_G = 10\Omega$ , $R_S = 0\Omega$		3		$\text{nV}/\sqrt{\text{Hz}}$
$+i_n$	Noninverting Input Noise Current Density	$f = 1\text{kHz}$ , $R_F = 1\text{k}$ , $R_G = 10\Omega$ , $R_S = 10\text{k}$		2		$\text{pA}/\sqrt{\text{Hz}}$
$-i_n$	Inverting Input Noise Current Density	$f = 1\text{kHz}$ , $R_F = 1\text{k}$ , $R_G = 10\Omega$ , $R_S = 10\text{k}$		20		$\text{pA}/\sqrt{\text{Hz}}$
$R_{IN}$	Input Resistance	$V_{IN} = \pm 13\text{V}$ , $V_S = \pm 15\text{V}$		1.5	10	$\text{M}\Omega$
		$V_{IN} = \pm 3\text{V}$ , $V_S = \pm 5\text{V}$		1.5	8	$\text{M}\Omega$
		$V_{IN} = \pm 0.5\text{V}$ , $V_S = \pm 2.5\text{V}$		1.5	8	$\text{M}\Omega$
$C_{IN}$	Input Capacitance			3		pF

## ELECTRICAL CHARACTERISTICS

$V_{CM} = 0V$ ,  $\pm 2.5V \leq V_S \leq \pm 15V$  (LT1497CS),  $\pm 2.5V \leq V_S \leq \pm 5V$  (LT1497CS8), pulse tested unless otherwise noted.

SYMBOL	PARAMETER	CONDITIONS	MIN	TYP	MAX	UNITS	
	Input Voltage Range	$V_S = \pm 15V$	•	±13	±14	V	
		$V_S = \pm 5V$	•	±3.0	±4.0	V	
		$V_S = \pm 2.5V$	•	±0.5	±1.5	V	
CMRR	Common Mode Rejection Ratio	$V_S = \pm 15V$ , $V_{CM} = \pm 13V$ , $T_A = 25^\circ C$	•	55	62	dB	
			•	53		dB	
		$V_S = \pm 5V$ , $V_{CM} = \pm 3V$ , $T_A = 25^\circ C$	•	54	60	dB	
			•	52		dB	
		$V_S = \pm 2.5V$ , $V_{CM} = \pm 0.5V$ , $T_A = 25^\circ C$	•	52	56	dB	
			•	50		dB	
	Inverting Input Current Common Mode Rejection	$V_S = \pm 15V$ , $V_{CM} = \pm 13V$	•		2.0	10	µA/V
		$V_S = \pm 5V$ , $V_{CM} = \pm 3V$	•		2.5	10	µA/V
		$V_S = \pm 2.5V$ , $V_{CM} = \pm 0.5V$	•		3.0	10	µA/V
PSRR	Power Supply Rejection Ratio	$V_S = \pm 2V$ to $\pm 15V$ , $T_A = 25^\circ C$	•	66	76	dB	
			•	63		dB	
		$V_S = \pm 2V$ to $\pm 5V$ , $T_A = 25^\circ C$	•	66	76	dB	
			•	63		dB	
	Noninverting Input Current Power Supply Rejection	$V_S = \pm 2V$ to $\pm 15V$	•		5	50	nA/V
		$V_S = \pm 2V$ to $\pm 5V$	•		5	50	nA/V
	Inverting Input Current Power Supply Rejection	$V_S = \pm 2V$ to $\pm 15V$	•		0.1	2	µA/V
		$V_S = \pm 2V$ to $\pm 5V$	•		0.1	2	µA/V
$A_{VOL}$	Large-Signal Voltage Gain	$V_S = \pm 15V$ , $V_{OUT} = \pm 10V$ , $R_L = 150\Omega$	•	66	80	dB	
		$V_S = \pm 5V$ , $V_{OUT} = \pm 2.5V$ , $R_L = 50\Omega$	•	66	80	dB	
		$V_S = \pm 2.5V$ , $V_{OUT} = \pm 0.5V$ , $R_L = 50\Omega$	•	66	80	dB	
$R_{OL}$	Transresistance, $\Delta V_{OUT}/\Delta I_{IN}^-$	$V_S = \pm 15V$ , $V_{OUT} = \pm 10V$ , $R_L = 150\Omega$	•	100	500	kΩ	
		$V_S = \pm 5V$ , $V_{OUT} = \pm 2.5V$ , $R_L = 50\Omega$	•	100	500	kΩ	
		$V_S = \pm 2.5V$ , $V_{OUT} = \pm 0.5V$ , $R_L = 50\Omega$	•	100	300	kΩ	
$V_{OUT}$	Maximum Output Swing	$V_S = \pm 15V$ , $R_L = 150\Omega$ , $T_A = 25^\circ C$	•	±12.80	±13.15	V	
			•	±12.60		V	
		$V_S = \pm 15V$ , $I_L = \pm 100mA$ , $T_A = 25^\circ C$	•	±12.65	±13.0	V	
			•	±12.55		V	
		$V_S = \pm 5V$ , $R_L = 50\Omega$ , $T_A = 25^\circ C$	•	±3.20	±3.45	V	
			•	±3.10		V	
		$V_S = \pm 5V$ , $I_L = \pm 100mA$ , $T_A = 25^\circ C$	•	±2.75	±3.10	V	
			•	±2.65		V	
		$V_S = \pm 2.5V$ , $R_L = 50\Omega$ , $T_A = 25^\circ C$	•	±1.25	±1.45	V	
			•	±1.15		V	
		$V_S = \pm 2.5V$ , $I_L = \pm 50mA$ , $T_A = 25^\circ C$	•	±1.00	±1.15	V	
			•	±0.90		V	
$I_{OUT}$	Maximum Output Current	$R_L = 1\Omega$ , $V_S = \pm 15V$	•	±125	±220	mA	
		$R_L = 1\Omega$ , $V_S = \pm 5V$	•	±125	±220	mA	
		$R_L = 1\Omega$ , $V_S = \pm 2.5V$			±140	mA	
$I_S$	Supply Current per Amplifier	$V_S = \pm 2.5V$ to $\pm 5V$ , $T_A = 25^\circ C$	•		6.0	7.0	mA
			•			8.0	mA
		$V_S = \pm 15V$ , $T_A = 25^\circ C$	•		7.0	9.0	mA
			•			10.5	mA
	Channel Separation	$V_S = \pm 15V$ , $V_{OUT} = \pm 10V$ , $R_L = 150\Omega$	•	100	120	dB	
		$V_S = \pm 5V$ , $V_{OUT} = \pm 2.5V$ , $R_L = 50\Omega$	•	100	115	dB	

## ELECTRICAL CHARACTERISTICS

$V_{CM} = 0V$ ,  $\pm 2.5V \leq V_S \leq \pm 15V$  (LT1497CS),  $\pm 2.5V \leq V_S \leq \pm 5V$  (LT1497CS8), pulse tested unless otherwise noted.

SYMBOL	PARAMETER	CONDITIONS	MIN	TYP	MAX	UNITS
SR	Slew Rate	$V_S = \pm 15V$ , $T_A = 25^\circ C$ (Note 4)	500	900		V/ $\mu s$
			400			V/ $\mu s$
		$V_S = \pm 5V$ , $T_A = 25^\circ C$ (Note 4)	200	350		V/ $\mu s$
			150			V/ $\mu s$
BW	Small-Signal Bandwidth	$V_S = \pm 15V$ , $R_F = R_G = 560\Omega$ , $R_L = 100\Omega$		50		MHz
		$V_S = \pm 5V$ , $R_F = R_G = 560\Omega$ , $R_L = 100\Omega$		35		MHz
		$V_S = \pm 2.5V$ , $R_F = R_G = 560\Omega$ , $R_L = 100\Omega$		30		MHz
$t_r$	Small-Signal Rise Time	$V_S = \pm 15V$ , $R_F = R_G = 560\Omega$ , $R_L = 100\Omega$		7.5		ns
		$V_S = \pm 5V$ , $R_F = R_G = 560\Omega$ , $R_L = 100\Omega$		9.5		ns
		$V_S = \pm 2.5V$ , $R_F = R_G = 560\Omega$ , $R_L = 100\Omega$		11		ns
	Overshoot	$V_S = \pm 15V$ , $R_F = R_G = 560\Omega$ , $R_L = 100\Omega$		15		%
		$V_S = \pm 5V$ , $R_F = R_G = 560\Omega$ , $R_L = 100\Omega$		12		%
		$V_S = \pm 2.5V$ , $R_F = R_G = 560\Omega$ , $R_L = 100\Omega$		10		%
	Propagation Delay	$V_S = \pm 15V$ , $R_F = R_G = 560\Omega$ , $R_L = 100\Omega$		6.8		ns
		$V_S = \pm 5V$ , $R_F = R_G = 560\Omega$ , $R_L = 100\Omega$		8.4		ns
		$V_S = \pm 2.5V$ , $R_F = R_G = 560\Omega$ , $R_L = 100\Omega$		9.7		ns
$t_s$	Settling Time	$V_S = \pm 15V$ , 10V Step, 0.1%, $A_V = -1$		55		ns
		$V_S = \pm 5V$ , 5V Step, 0.1%, $A_V = -1$		50		ns
	Differential Gain (Note 5)	$V_S = \pm 15V$ , $R_F = R_G = 510\Omega$ , $R_L = 150\Omega$		0.02		%
		$V_S = \pm 15V$ , $R_F = R_G = 510\Omega$ , $R_L = 50\Omega$		0.19		%
		$V_S = \pm 5V$ , $R_F = R_G = 510\Omega$ , $R_L = 150\Omega$		0.08		%
		$V_S = \pm 5V$ , $R_F = R_G = 510\Omega$ , $R_L = 50\Omega$		0.41		%
	Differential Phase (Note 5)	$V_S = \pm 15V$ , $R_F = R_G = 510\Omega$ , $R_L = 150\Omega$		0.015		Deg
		$V_S = \pm 15V$ , $R_F = R_G = 510\Omega$ , $R_L = 50\Omega$		0.235		Deg
		$V_S = \pm 5V$ , $R_F = R_G = 510\Omega$ , $R_L = 150\Omega$		0.045		Deg
		$V_S = \pm 5V$ , $R_F = R_G = 510\Omega$ , $R_L = 50\Omega$		0.310		Deg

The ● denotes specifications which apply over the full operating temperature range.

**Note 1:** Applies to short circuits to ground only. A short circuit between the output and either supply may damage the part when operated on supplies greater than  $\pm 10V$

**Note 2:** The LT1497 is designed, characterized and expected to operate over the temperature range of  $-40^\circ C$  to  $85^\circ C$ , but is not tested at  $-40^\circ C$  and  $85^\circ C$ . Guaranteed industrial grade parts are available, consult factory.

**Note 3:** Thermal resistance varies depending upon the amount of PC board metal attached to the device.  $\theta_{JA}$  is specified for a  $2500mm^2$  test board covered with 2oz copper on both sides.

**Note 4:** Slew rate is measured between  $\pm 5V$  on a  $\pm 10V$  output signal while operating on  $\pm 15V$  supplies with  $R_F = 453\Omega$ ,  $R_G = 49.9\Omega$  and  $R_L = 150\Omega$ . On  $\pm 5V$  supplies slew rate is measured between  $\pm 1V$  on a  $\pm 3V$  output signal. The slew rate is much higher when the input is overdriven and when the amplifier is operated inverting. See the Applications Information section.

**Note 5:** NTSC composite video with an amplifier output level of 2V peak.

# SMALL-SIGNAL BANDWIDTH

$V_S = \pm 15V$ , Peaking  $\leq 1dB$

$A_V$	$R_L$	$R_F$	$R_G$	-3dB BW (MHz)
-1	150	560	560	59.2
	50	560	560	43.1
	20	620	620	30.0
1	150	560	-	57.0
	50	560	-	42.7
	20	560	-	30.3
2	150	510	510	59.1
	50	560	560	41.7
	20	620	620	20.7
10	150	270	30	43.4
	50	270	30	30.9
	20	270	30	19.0

$V_S = \pm 5V$ , Peaking  $\leq 1dB$

$A_V$	$R_L$	$R_F$	$R_G$	-3dB BW (MHz)
-1	150	510	510	45.0
	50	560	560	32.0
	20	560	560	23.2
1	150	510	-	44.3
	50	560	-	31.7
	20	560	-	22.9
2	150	510	510	41.7
	50	560	560	30.4
	20	560	560	21.9
10	150	270	30	28.1
	50	270	30	21.9
	20	270	30	14.6

# TYPICAL PERFORMANCE CHARACTERISTICS

Voltage Gain and Phase vs Frequency, Gain = 6dB

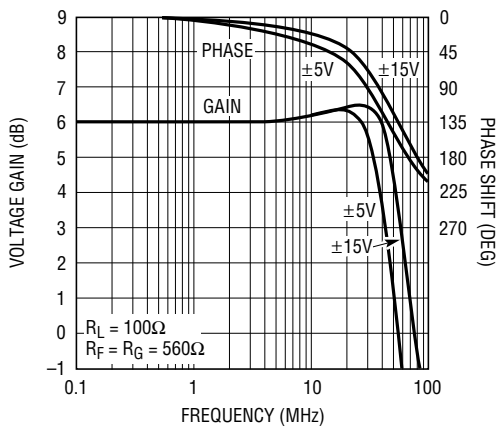

1497 G01

-3dB Bandwidth vs Supply Voltage

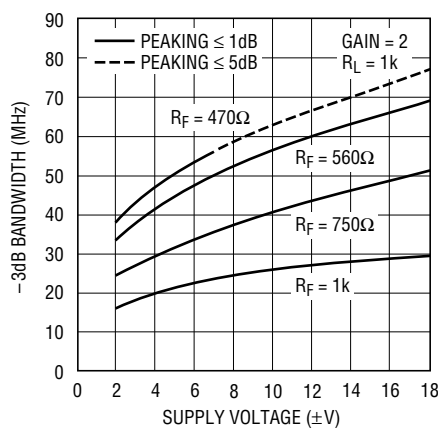

1497 G02

-3dB Bandwidth vs Supply Voltage

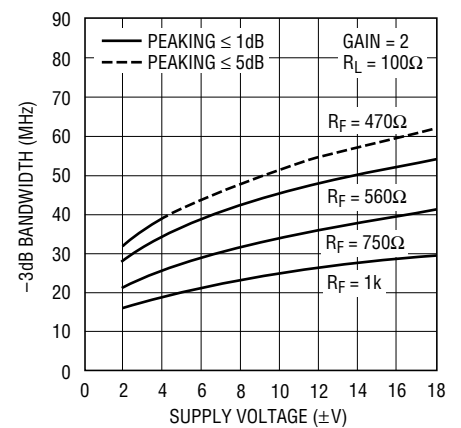

1497 G03

Voltage Gain and Phase vs Frequency, Gain = 20dB

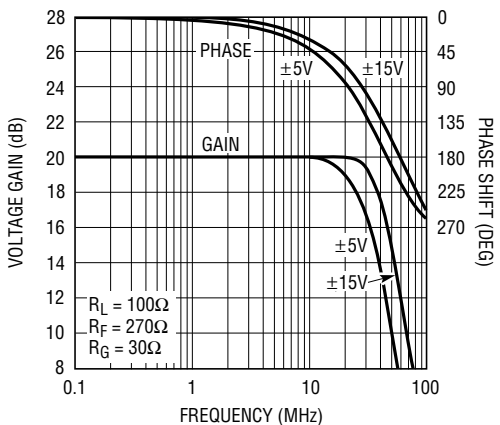

1497 G04

-3dB Bandwidth vs Supply Voltage

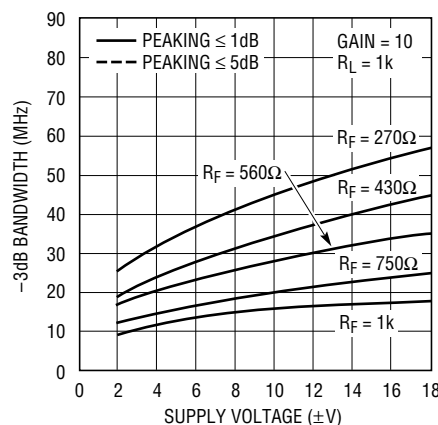

1497 G05

-3dB Bandwidth vs Supply Voltage

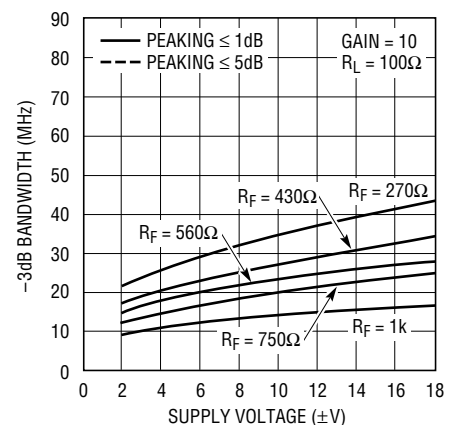

1497 G06

# TYPICAL PERFORMANCE CHARACTERISTICS

**Differential Phase vs Supply Voltage**

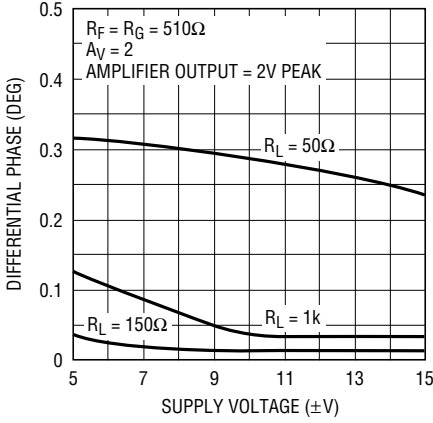

1497 G07

**Differential Gain vs Supply Voltage**

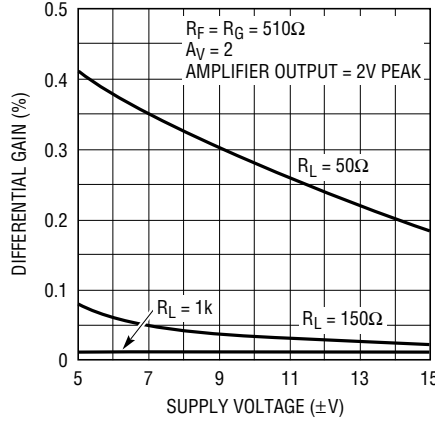

1497 G08

**Maximum Capacitive Load vs Feedback Resistor**

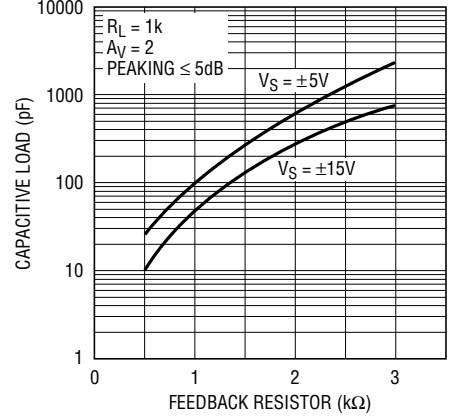

1497 G09

**Output Saturation Voltage vs Junction Temperature, ±15V**

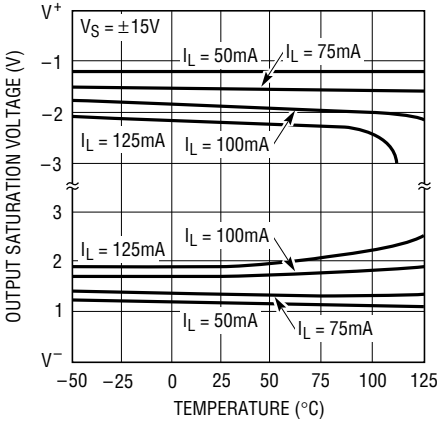

1497 G10

**Output Saturation Voltage vs Junction Temperature, ±5V**

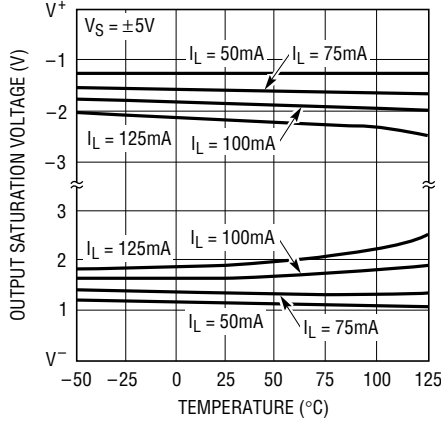

1497 G11

**Output Saturation Voltage vs Junction Temperature, ±2.5V**

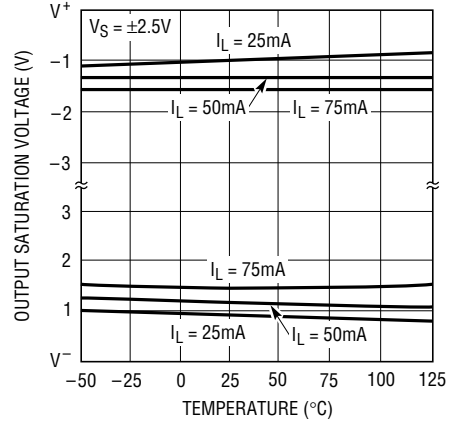

1497 G12

**Supply Current vs Ambient Temperature**

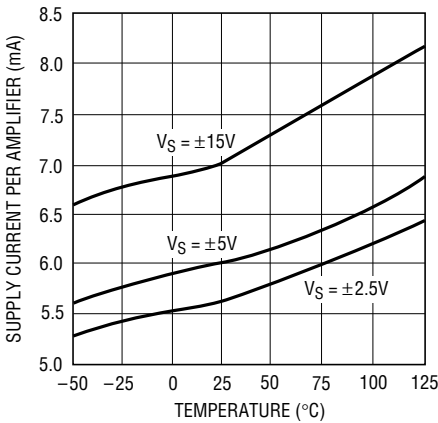

1497 G13

**Input Common Mode Limit vs Junction Temperature**

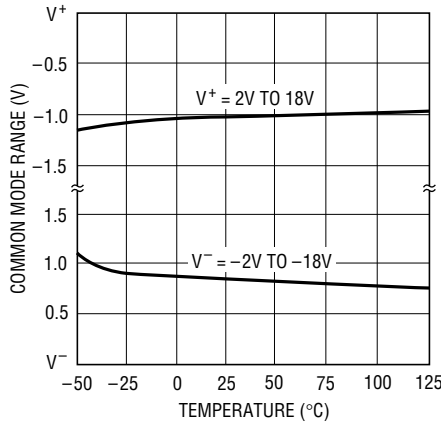

1497 G14

**Output Short-Circuit Current vs Junction Temperature**

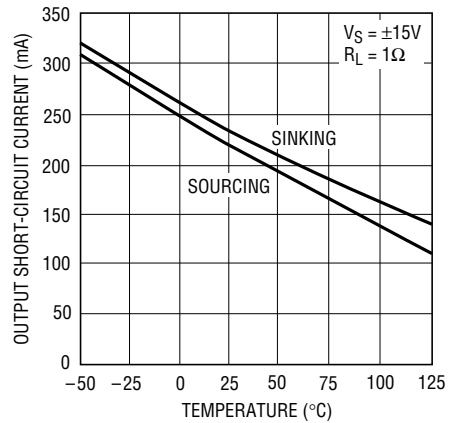

1497 G15

# TYPICAL PERFORMANCE CHARACTERISTICS

**Settling Time to 10mV vs Output Step**

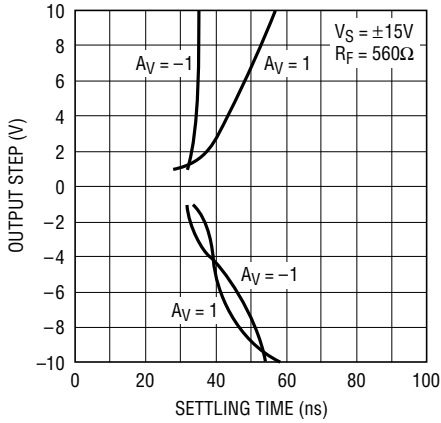

1497 G16

**Settling Time to 1mV vs Output Step**

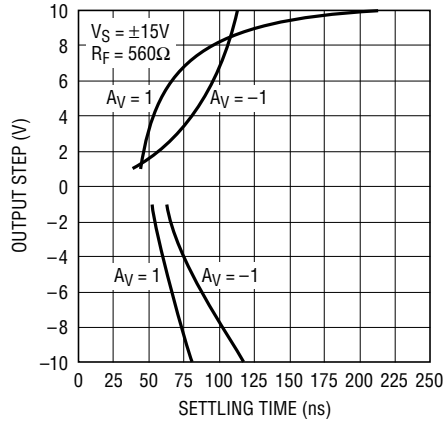

1497 G17

**Spot Noise Voltage and Current vs Frequency**

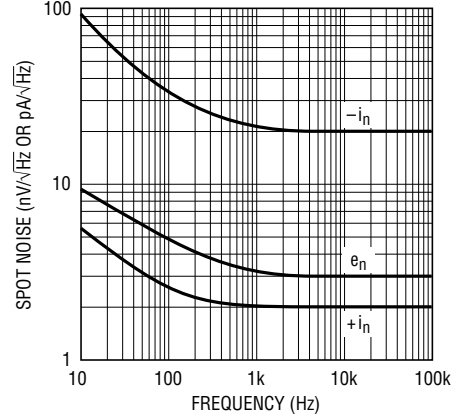

1497 G18

**Total Harmonic Distortion vs Frequency**

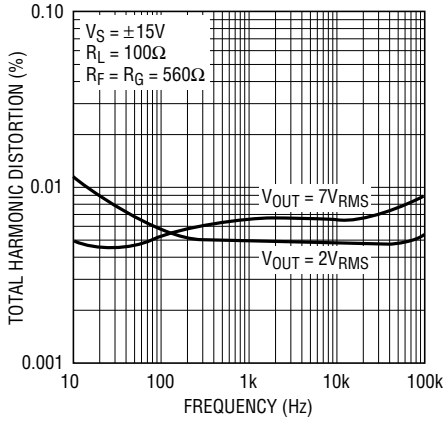

1497 G19

**2nd and 3rd Harmonic Distortion vs Frequency**

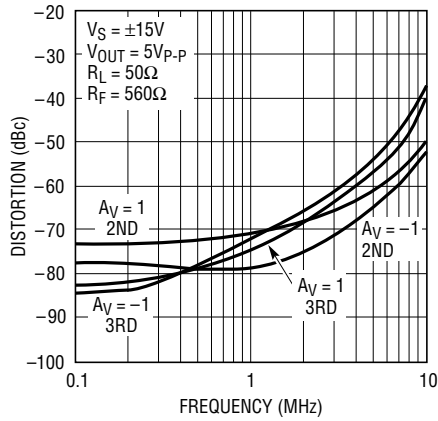

1497 G20

**3rd Order Intercept vs Frequency**

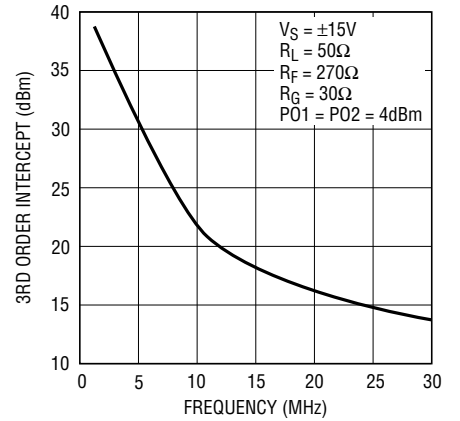

1497 G21

**Output Impedance vs Frequency**

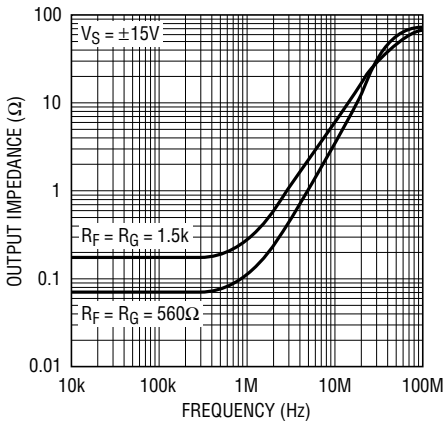

1497 G22

**Power Supply Rejection vs Frequency**

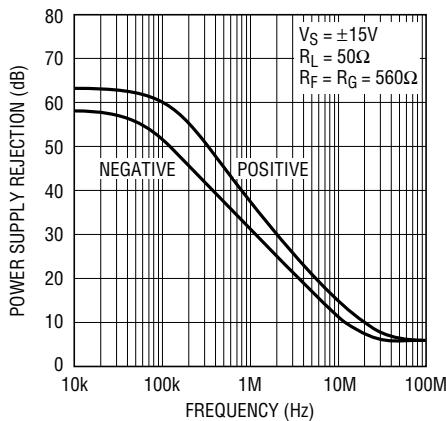

1497 G23

**Amplifier Crosstalk vs Frequency**

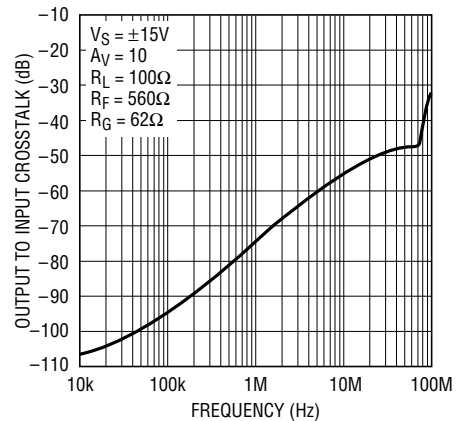

1497 G24



## APPLICATIONS INFORMATION

The LT1497 is a dual current feedback amplifier with high output current drive capability. Bandwidth is maintained over a wide range of voltage gains by the appropriate choice of feedback resistor. These amplifiers will drive low impedance loads such as cables with excellent linearity at high frequencies.

### Feedback Resistor Selection

The optimum value for the feedback resistor is a function of the operating conditions of the device, the load impedance and the desired flatness of frequency response. The Small-Signal Bandwidth table gives the values which result in the highest bandwidth with less than 1dB of peaking for various gains, loads and supply voltages. If this level of flatness is not required, a higher bandwidth can be obtained by use of a lower feedback resistor. The characteristic curves of Bandwidth vs Supply Voltage indicate feedback resistors for peaking up to 5dB. These curves use a solid line when the response has less than 1dB of peaking and a dashed line when the response has 1dB to 5dB of peaking. Note that in a gain of 10 peaking is always under 1dB for the resistor ranges shown. Reducing the feedback resistor further than  $270\Omega$  in a gain of 10 will increase the bandwidth, but it also loads the amplifier and reduces the maximum current available to drive the load.

### Capacitive Loads

The LT1497 can drive capacitive loads directly when the proper value of feedback resistor is used. The graph of Maximum Capacitive Load vs Feedback Resistor should be used to select the appropriate value. The graph shows feedback resistor values for 5dB frequency peaking when driving a 1k load at a gain of 2. This is a worst-case condition. The amplifier is more stable at higher gains and driving heavier loads (smaller load resistors). Alternatively, a small resistor ( $10\Omega$  to  $20\Omega$ ) can be put in series with the output to isolate the capacitive load from the amplifier output. This has the advantage in that the amplifier bandwidth is only reduced when the capacitive load is present, and the disadvantage that the gain is a function of the load resistance.

### Capacitance on the Inverting Input

Current feedback amplifiers require resistive feedback from the output to the inverting input for stable operation. Take care to minimize the stray capacitance between the output and the inverting input. Capacitance on the inverting input to ground will cause peaking in the frequency response (and overshoot in the transient response), but it does not degrade the stability of the amplifier.

### Power Supplies

The LT1497 will operate on single or split supplies from  $\pm 2V$  (4V total) to  $\pm 15V$  (30V total). It is not necessary to use equal value split supplies, however, the offset voltage and inverting input bias current will change. The offset voltage changes about 1mV per volt of supply mismatch. The inverting bias current can change as much as  $10\mu A$  per volt of supply mismatch, though typically the change is less than  $2.5\mu A$  per volt.

### Thermal Considerations

The LT1497 contains a thermal shutdown feature that protects against excessive internal (junction) temperature. If the junction temperature of the device exceeds the protection threshold, the device will begin cycling between normal operation and an off state. The cycling is not harmful to the part. The thermal cycling occurs at a slow rate, typically 10ms to several seconds, depending upon the power dissipation and the thermal time constants of the package and the amount of copper on the board under the package. Raising the ambient temperature until the device begins thermal shutdown gives a good indication of how much margin there is in the thermal design.

For surface mount devices heat sinking is accomplished by using the heat spreading capabilities of the PC board and its copper traces. Experiments have shown that the heat spreading copper layer does not need to be electrically connected to the leads of the device. The PCB material can be very effective at transmitting heat between the pad area attached to  $V^-$  pins of the device and a ground



## APPLICATIONS INFORMATION

or power plane layer either inside or on the opposite side of the board. Copper board stiffeners and plated through-holes can also be used to spread the heat generated by the device. Table 1 lists the thermal resistance for several different board sizes and copper areas. All measurements were taken in still air on 3/32" FR-4 board with 2oz copper. This data can be used as a rough guideline in estimating thermal resistance. The thermal resistance for each application will be affected by thermal interactions with other components as well as board size and shape.

**Table 1. Fused 16-lead and 8-lead SO Packages**

COPPER AREA (2oz)		TOTAL COPPER AREA	$\theta_{JA}$ (16-LEAD)	$\theta_{JA}$ (8-LEAD)
TOPSIDE	BACKSIDE			
2500mm <sup>2</sup>	2500mm <sup>2</sup>	5000mm <sup>2</sup>	40°C/W	80°C/W
1000mm <sup>2</sup>	2500mm <sup>2</sup>	3500mm <sup>2</sup>	46°C/W	92°C/W
600mm <sup>2</sup>	2500mm <sup>2</sup>	3100mm <sup>2</sup>	48°C/W	96°C/W
180mm <sup>2</sup>	2500mm <sup>2</sup>	2680mm <sup>2</sup>	49°C/W	98°C/W
180mm <sup>2</sup>	1000mm <sup>2</sup>	1180mm <sup>2</sup>	56°C/W	112°C/W
180mm <sup>2</sup>	600mm <sup>2</sup>	780mm <sup>2</sup>	58°C/W	116°C/W
180mm <sup>2</sup>	300mm <sup>2</sup>	480mm <sup>2</sup>	59°C/W	118°C/W
180mm <sup>2</sup>	100mm <sup>2</sup>	280mm <sup>2</sup>	60°C/W	120°C/W
180mm <sup>2</sup>	0mm <sup>2</sup>	180mm <sup>2</sup>	61°C/W	122°C/W

### Calculating Junction Temperature

The junction temperature can be calculated from the equation:

$$T_J = (P_D)(\theta_{JA}) + T_A$$

$T_J$  = Junction Temperature

$T_A$  = Ambient Temperature

$P_D$  = Power Dissipation

$\theta_{JA}$  = Thermal Resistance (Junction-to-Ambient)

As an example, calculate the junction temperature for the circuit in Figure 1 assuming an 85°C ambient temperature.

The device dissipation can be found by measuring the supply currents, calculating the total dissipation and then subtracting the dissipation in the load and feedback network. Both amplifiers are in a gain of -1.

The dissipation for each amplifier is:

$$P_D = (1/2)(86.4\text{mA})(30\text{V}) - (10\text{V})^2 / (200\Omega || 560\Omega) = 0.62\text{W}$$

The total dissipation is 1.24W. When a 2500mm<sup>2</sup> PC board with 2oz copper on top and bottom is used, the

thermal resistance is 40°C/W. The junction temperature  $T_J$  is:

$$T_J = (1.24\text{W})(40^\circ\text{C/W}) + 85^\circ\text{C} = 135^\circ\text{C}$$

The maximum junction temperature for the LT1497 is 150°C, so the heat sinking capability of the board is adequate for the application.

If the copper area on the PC board is reduced to 180mm<sup>2</sup> the thermal resistance increases to 61°C/W and the junction temperature becomes:

$$T_J = (1.24\text{W})(61^\circ\text{C/W}) + 85^\circ\text{C} = 161^\circ\text{C}$$

which is above the maximum junction temperature indicating that the heat sinking capability of the board is inadequate and should be increased.

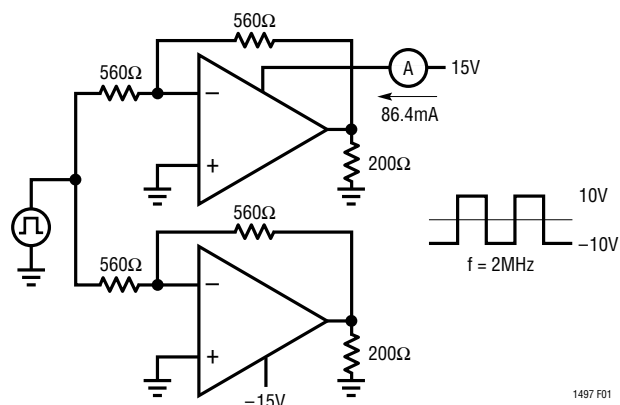

**Figure 1. Thermal Calculation Example**

### Slew Rate

Unlike a traditional op amp, the slew rate of a current feedback amplifier is not independent of the amplifier gain configuration. There are slew rate limitations in both the input stage and the output stage. In the inverting mode and for higher gains in the noninverting mode, the signal amplitude on the input pins is small and the overall slew rate is that of the output stage. The input stage slew rate is related to the quiescent current in the input devices.

Referring to the Simplified Schematic, for noninverting applications the two current sources in the input stage slew the parasitic internal capacitances at the bases of Q3 and Q4. Consider a positive going input at the base of Q1 and Q2. If the input slew rate exceeds the internal slew rate,

## APPLICATIONS INFORMATION

the normally active emitter of Q2 will turn off as the entire current available from the current source is used to slew the base of Q3. The base of Q4 is driven by Q1 without slew limitation. When the differential input voltage exceeds two diode drops (about 1.4V) the extra clamp emitter on Q1 turns on and drives the base of Q3 directly. Once the base of Q3 has been driven within 1.4V of its final value, the clamp emitter of Q1 turns off and the node must finish slewing using the current source.

This effect can be seen in Figure 2 which shows the large signal behavior in a gain of 1 on  $\pm 15V$  supplies. The clamping action enhances the slew rate beyond the input limitation, but always leads to slew overshoot after the clamps turn off. Figure 3 shows that for higher gain

configurations there is much less slew rate enhancement because the input only moves 2V, barely enough to turn on the input clamps. In inverting configurations as shown in Figure 4 the noninverting input does not move so there is no input slew rate limitation. Slew overshoot is due to capacitance on the inverting input and can be reduced with a larger feedback resistor.

The output slew rate is set by the value of the feedback resistors and the internal capacitance. Larger feedback resistors will reduce the slew rate as will lower supply voltages, similar to the way the bandwidth is reduced. The larger feedback resistors will also cut back on slew overshoot.

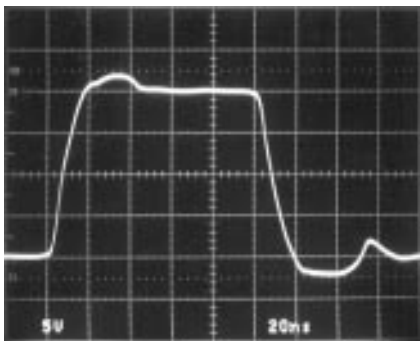

$A_V = 1$   $R_F = 560\Omega$   
 $V_S = \pm 15V$   $R_L = 100\Omega$

1497 F02

Figure 2. Large-Signal Response

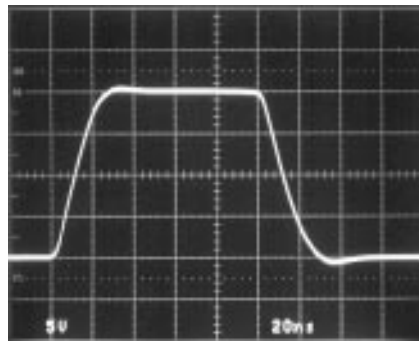

$A_V = 10$   $R_F = 560\Omega$   $R_G = 62\Omega$   
 $V_S = \pm 15V$   $R_L = 100\Omega$

1497 F03

Figure 3. Large-Signal Response

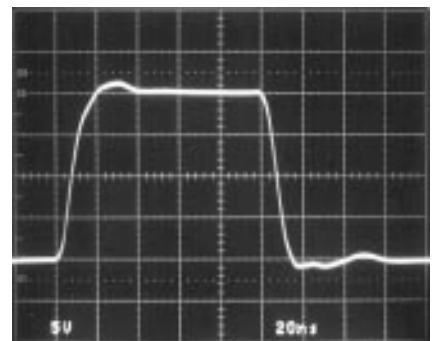

$A_V = -1$   $R_F = R_G = 560\Omega$   
 $V_S = \pm 15V$   $R_L = 100\Omega$

1497 F04

Figure 4. Large-Signal Response

## SIMPLIFIED SCHEMATIC

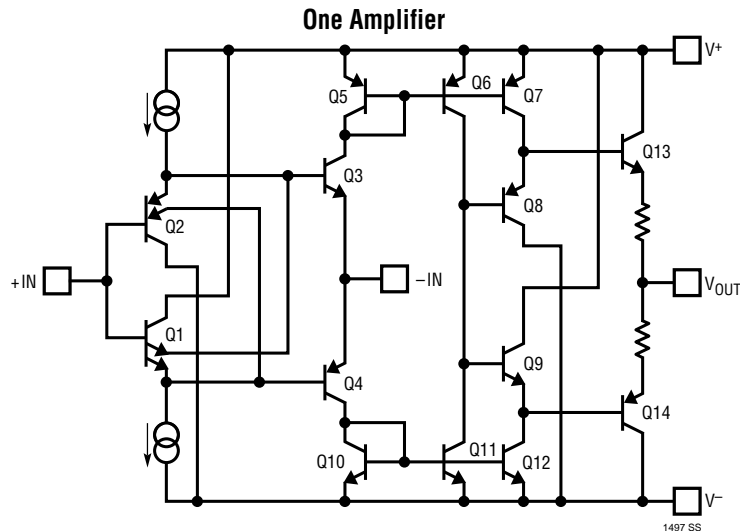

1497 SS

# TYPICAL APPLICATIONS

Differential Input/Differential Output Power Amp ( $A_V = 2$ )

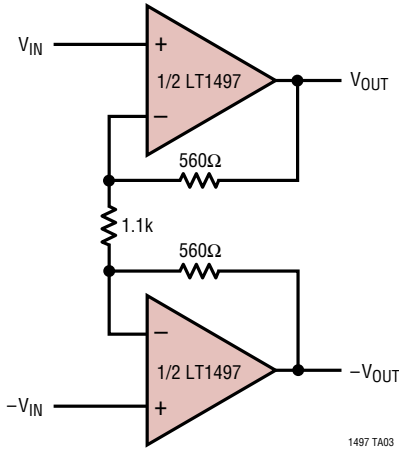

Paralleling Both Amplifiers for Guaranteed 250mA Output Drive

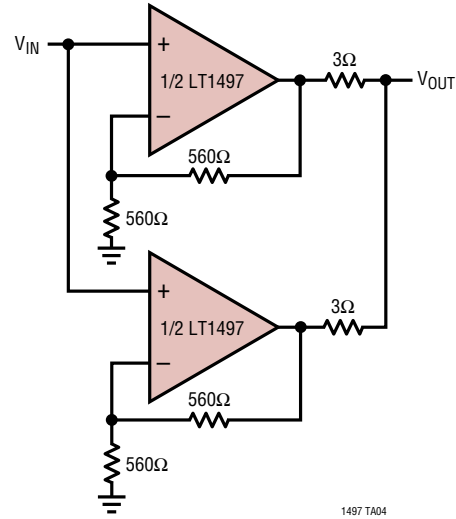

# PACKAGE DESCRIPTION

Dimensions in inches (millimeters) unless otherwise noted.

**S8 Package**  
**8-Lead Plastic Small Outline (Narrow 0.150)**  
 (LTC DWG # 05-08-1610)

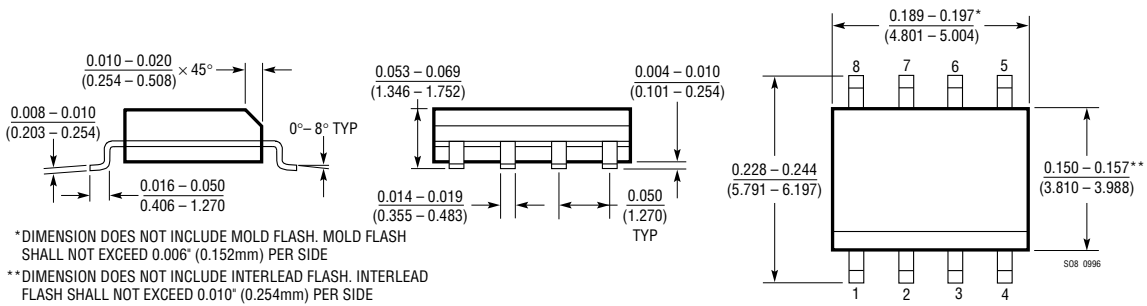

**S Package**  
**16-Lead Plastic Small Outline (Narrow 0.150)**  
 (LTC DWG # 05-08-1610)

