

250MHz, Triple and Single RGB Multiplexer with Amplifiers

FEATURES

- 100MHz Pixel Switching
- -3dB Bandwidth: 250MHz
- Channel Switching Time: 2.5ns
- Expandable to Larger Arrays
- Drives Cables Directly
- High Slew Rate: 1100V/μs
- Low Switching Transient: 50mV
- Shutdown Supply Current: 100μA
- Output Short-Circuit Protected
- Available in Small 16-Pin SSOP Package

APPLICATIONS

- RGB Switching
- Workstation Graphics
- Pixel Switching
- Coaxial Cable Drivers
- High Speed Signal Processing

DESCRIPTION

The LT[®]1675 is a high speed RGB multiplexer designed for pixel switching and fast workstation graphics. Included on chip are three SPDT switches and three current feedback amplifiers. The current feedback amplifiers drive double-terminated 50Ω or 75Ω cables and are

configured for a fixed gain of 2, eliminating six external gain setting resistors. The SPDT switches are designed to be break-before-make to minimize unwanted signals coupling to the input.

The LT1675-1 is a single version with two inputs, a single output and is ideal for a single channel application such as video sync.

The key to the LT1675 fast switching speed is Linear Technology's proprietary high speed bipolar process. This MUX can toggle between sources in excess of 100MHz, has a slew rate over 1000V/μs and has a -3dB bandwidth of 250MHz. Power supply requirements are ±4V to ±6V and power dissipation is only 300mW on ±5V, or 100mW for the LT1675-1. The expandable feature uses the disable pin to reduce the power dissipation to near 0mW in the off parts.

Unlike competitive solutions that are in bulky high pin count packages, the LT1675 is in a 16-lead narrow body SSOP. This small footprint, the size of an SO-8, results in a very clean high performance solution. The LT1675-1 is available in the tiny MSOP and the SO-8.

LT, LTC and LT are registered trademarks of Linear Technology Corporation. All other trademarks are the property of their respective owners.

TYPICAL APPLICATION



Clocking Between 2 DC Levels at 100MHz



LT1675/LT1675-1

ABSOLUTE MAXIMUM RATINGS (Note 1)

Supply Voltage	$\pm 6.3V$	Operating Temperature Range (Note 3) ..	$-40^{\circ}C$ to $85^{\circ}C$
Inputs, ENABLE and SELECT, Current	$\pm 20mA$	Storage Temperature Range	$-65^{\circ}C$ to $150^{\circ}C$
Output Short-Circuit Duration (Note 2)	Continuous	Junction Temperature (Note 4)	$150^{\circ}C$
Specified Temperature Range	$0^{\circ}C$ to $70^{\circ}C$	Lead Temperature (Soldering, 10 sec)	$300^{\circ}C$

PACKAGE/ORDER INFORMATION

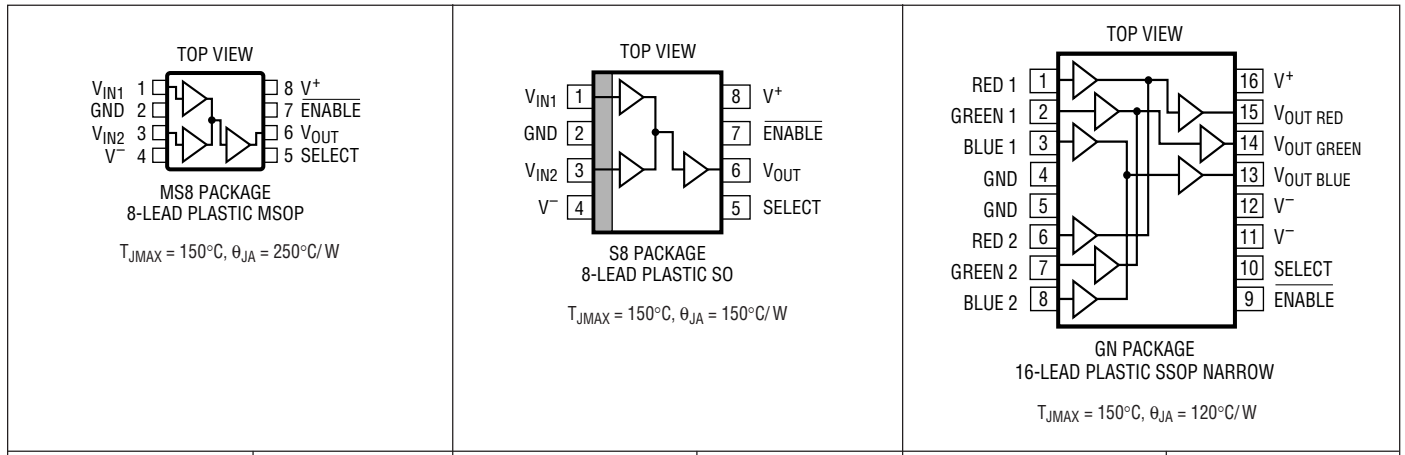

ORDER PART NUMBER	MS8 PART MARKING	ORDER PART NUMBER	S8 PART MARKING	ORDER PART NUMBER	GN PART MARKING
LT1675CMS8-1	LTX	LT1675CS8-1	16751	LT1675CGN	1675

Order Options Tape and Reel: Add #TR
 Lead Free: Add #PBF, Lead Free Tape and Reel: Add #TRPBF, Lead Free Part Marking: <http://www.linear.com/leadfree/>

Consult LTC Marketing for parts specified with wider operating temperature ranges.

ELECTRICAL CHARACTERISTICS The ● denotes the specifications which apply over the specified temperature range, otherwise specifications are at $T_A = 25^\circ\text{C}$. $V_S = \pm 5\text{V}$, $R_L = \infty$, $V_{IN} = 0\text{V}$ LT1675 (Pins 1, 2, 3, 6, 7, 8), LT1675-1 (Pins 1, 3), $\text{ENABLE} = 0\text{V}$, unless otherwise specified.

PARAMETER	CONDITIONS		MIN	TYP	MAX	UNITS	
Output Offset Voltage	Any Input Selected		●	20	50	mV	
Output Offset Matching	Between Outputs R1 to R2, G1 to G2, B1 to B2		●	5	20	mV	
Input Current	Any Input Selected		●	-12	-30	μA	
Input Resistance	$V_{IN} = \pm 1\text{V}$		●	100	700	$\text{k}\Omega$	
PSRR	$V_S = \pm 2.6\text{V}$ to $\pm 6\text{V}$, Measured at Output		●	38	50	dB	
DC Gain Error 0V to 1V	$V_{IN} = 1\text{V}$, $R_L = \infty$		●	3	6	%	
	$V_{IN} = 1\text{V}$, $R_L = 150\Omega$		●	4	8	%	
	$V_{IN} = 1\text{V}$, $R_L = 75\Omega$		●	5	10	%	
DC Gain Error 0V to -1V	$V_{IN} = -1\text{V}$, $R_L = \infty$		●	3	6	%	
	$V_{IN} = -1\text{V}$, $R_L = 150\Omega$		●	4	8	%	
	$V_{IN} = -1\text{V}$, $R_L = 75\Omega$		●	8	20	%	
Output Voltage	$V_{IN} = 2\text{V}$, $R_L = \infty$		●	3.1	3.4	V	
	$V_{IN} = 2\text{V}$, $R_L = 150\Omega$		●	2.7	3.0	V	
	$V_{IN} = 2\text{V}$, $R_L = 75\Omega$		●	2.4	2.8	V	
	$V_{IN} = -2\text{V}$, $R_L = \infty$		●	-3.1	-3.3	V	
	$V_{IN} = -2\text{V}$, $R_L = 150\Omega$		●	-2.6	-3.0	V	
	$V_{IN} = -2\text{V}$, $R_L = 75\Omega$		●	-2.3	-2.6	V	
Disabled Output Impedance	$\overline{\text{ENABLE}}$ Open		●	1.1	1.5	2.0	$\text{k}\Omega$
Maximum Output Current	$V_{IN} = \pm 1\text{V}$, $V_O = 0\text{V}$		●	50	70	mA	
Supply Current	LT1675	$\overline{\text{ENABLE}} = 0\text{V}$	●	25	33	42	mA
		$\overline{\text{ENABLE}} = 4.7\text{V}$	●		1	100	μA
ENABLE Pin Current	LT1675-1	$\overline{\text{ENABLE}} = 0\text{V}$	●	8	11	14	mA
		$\overline{\text{ENABLE}} = 4.7\text{V}$	●		0.3	33	μA
ENABLE Pin Current	LT1675	$\overline{\text{ENABLE}} = 0\text{V}$	●		450	600	μA
	LT1675-1	$\overline{\text{ENABLE}} = 0\text{V}$	●		150	200	μA
SELECT Pin Current	LT1675	SELECT = 0V	●		90	180	μA
	LT1675-1	SELECT = 0V	●		30	60	μA
SELECT Low	SELECT (See Truth Table)		●		0.8	V	
SELECT High	SELECT (See Truth Table)		●	2		V	

LT1675/LT1675-1

AC CHARACTERISTICS

$T_A = 25^\circ\text{C}$. $V_S = \pm 5\text{V}$, $R_L = 150\Omega$, $V_{IN} = 0\text{V}$ LT1675 (Pins 1, 2, 3, 6, 7, 8), LT1675-1 (Pins 1, 3), $\overline{\text{ENABLE}} = 0\text{V}$, unless otherwise specified.

PARAMETER	CONDITIONS	MIN	TYP	MAX	UNITS
Slew Rate	$V_{OUT} = 5V_{P-P}$		1100		V/ μs
Full Power Bandwidth (Note 5)	$V_{OUT} = 6V_{P-P}$		58		MHz
Small-Signal -3dB Bandwidth	Less Than 1dB Peaking		250		MHz
Gain Flatness	Less Than 0.1dB		70		MHz
Gain Matching	R to G to B R1 to R2, G1 to G2, B1 to B2, LT1675-1 V_{IN1} to V_{IN2}		0.10 0.01		dB dB
Channel-to-Channel Select Time	R1 = 0V, R2 = 1V				
Delay Time	Measured from Time SELECT Pin Crosses Logic Threshold		5.0		ns
Switching Time	Time for V_{OUT} to Go from 0V to 1V		2.5		ns
Enable Time			10		ns
Disable Time			100		ns
Input Pin Capacitance			2		pF
SELECT Pin Capacitance	LT1675		2.2		pF
	LT1675-1		1.5		pF
ENABLE Pin Capacitance	LT1675		2.1		pF
	LT1675-1		1.5		pF
Output Pin Capacitance (Disabled)	$\overline{\text{ENABLE}}$ Open		4.4		pF
Small-Signal Rise Time	$V_{IN} = 300\text{mV}_{P-P}$, $R_L = 100\Omega$		1.85		ns
Propagation Delay	$V_{IN} = 300\text{mV}_{P-P}$, $R_L = 100\Omega$		3		ns
Overshoot	$V_{IN} = 300\text{mV}_{P-P}$, $R_L = 100\Omega$		10		%
On-Channel to Off-Channel Crosstalk	Measured at 10MHz		60		dB
Chip Disable Crosstalk	Measured at 10MHz, $\overline{\text{ENABLE}}$ Open		90		dB
Channel Select Output Transient	Measured Between Back Termination and Load		50		mV_{P-P}
Differential Gain (Note 6)			0.07		%
Differential Phase (Note 6)			0.05		DEG

Note 1: Absolute Maximum Ratings are those values beyond which the life of a device may be impaired.

Note 2: May require a heat sink.

Note 3: The LT1675/LT1675-1 are guaranteed to meet specified performance from 0°C to 70°C and are designed, characterized and expected to meet these extended temperature limits, but are not tested at -40°C and 85°C . Guaranteed I grade parts are available; consult factory.

Note 4: T_J is calculated from the ambient temperature T_A and power dissipation P_D according to the following formula:

$$\text{LT1675CGN: } T_J = T_A + (P_D)(120^\circ\text{C/W})$$

$$\text{LT1675CMS8-1: } T_J = T_A + (P_D)(250^\circ\text{C/W})$$

$$\text{LT1675CS8-1: } T_J = T_A + (P_D)(150^\circ\text{C/W})$$

Note 5: Full power bandwidth is calculated from the slew rate measurement:

$$\text{FPBW} = \text{SR}/2\pi V_{PEAK}$$

Note 6: Differential Gain and Phase are measured using a Tektronix TSG120 YC/NTSC signal generator and a Tektronix 1780R Video Measurement Set. The resolution of this equipment is 0.1% and 0.1° . Nine identical MUXs were cascaded giving an effective resolution of 0.011% and 0.011° .

Truth Table

SELECT	$\overline{\text{ENABLE}}$	LT1675			LT1675-1
		RED OUT	GREEN OUT	BLUE OUT	VOUT
1	0	RED 1	GREEN 1	BLUE 1	VIN1
0	0	RED 2	GREEN 2	BLUE 2	VIN2
X	1	OFF	OFF	OFF	OFF

16751fb

TYPICAL PERFORMANCE CHARACTERISTICS

Gain and Phase vs Frequency

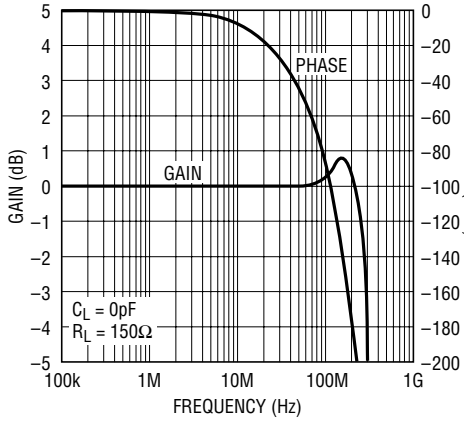

1675 G01

Frequency Response with Capacitive Loads

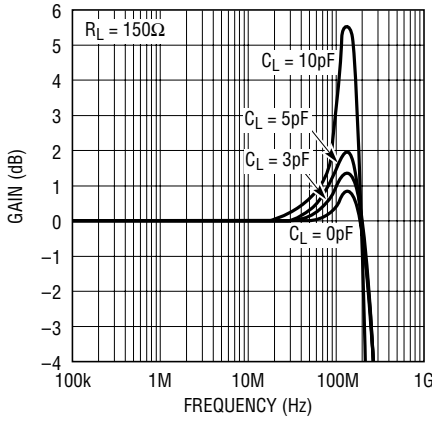

1675 G02

Gain vs Frequency

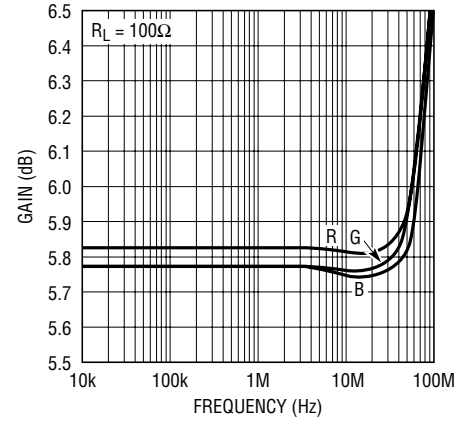

1675 G03

-3dB Bandwidth vs Supply Voltage

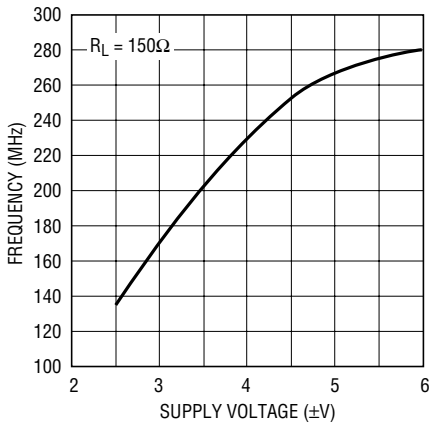

1675 G04

Crosstalk Rejection vs Frequency

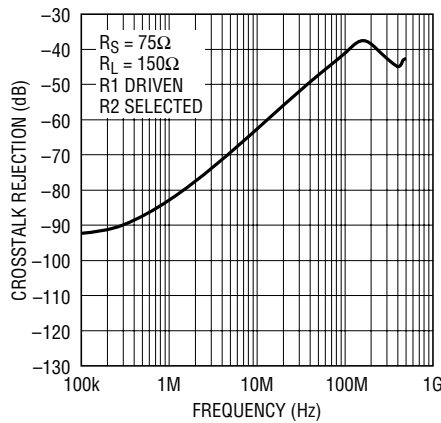

1675 G05

Crosstalk Rejection vs Frequency



1675 G23

Crosstalk Rejection vs Frequency (Disabled)

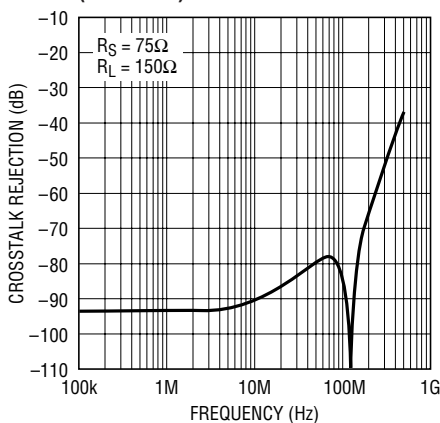

1675 G06

Power Supply Rejection Ratio vs Frequency

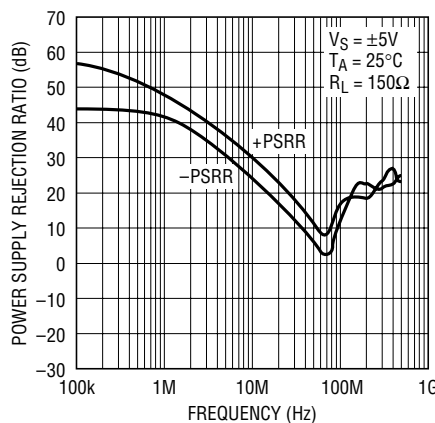

1675 G07

Undistorted Output Swing vs Frequency

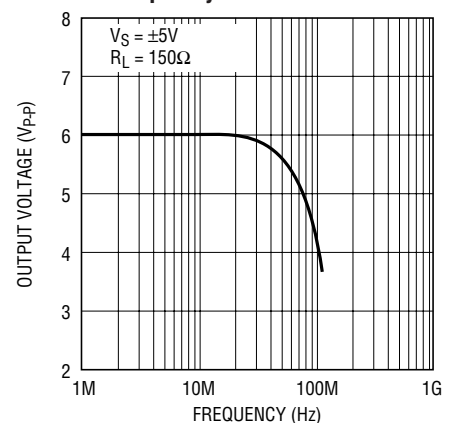

1675 G08

TYPICAL PERFORMANCE CHARACTERISTICS

Output Impedance vs Frequency



1675 G09

2nd and 3rd Harmonic Distortion vs Frequency



LTXXXX 1675 G10

Input Bias Current vs Input Voltage



1675 G12

Output Short-Circuit Current vs Temperature



1675 G13

Positive DC Gain Error vs Temperature



1675 G14

Negative DC Gain Error vs Temperature



1675 G15

Output Voltage vs Input Voltage

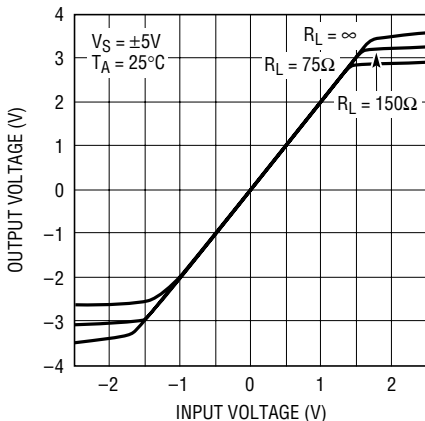

1675 G16

Supply Current vs Supply Voltage

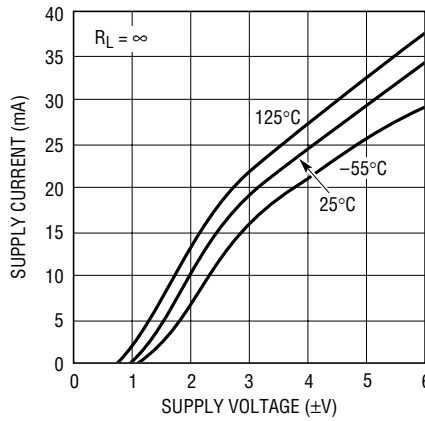

1675 G11

LT1675-1 Supply Current vs Supply Voltage

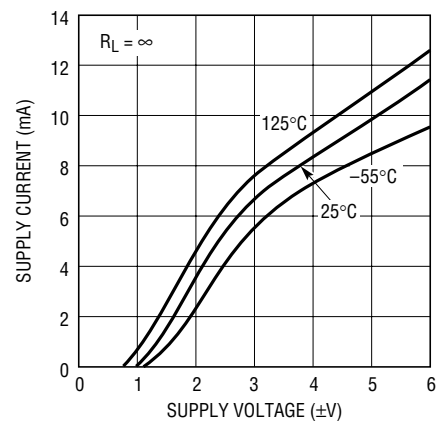

1675 G24

16751fb

TYPICAL PERFORMANCE CHARACTERISTICS

Input Bias Current vs Temperature

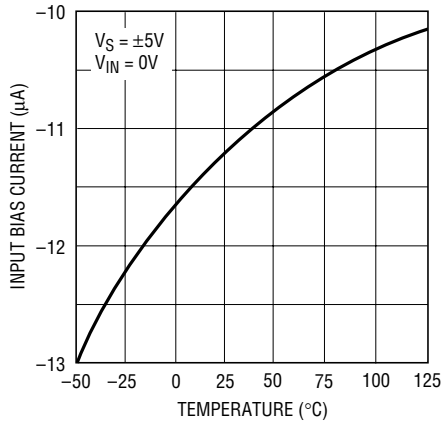

1675 G17

Output Offset Voltage vs Temperature



1675 G18

Toggling RED 2 to RED 1



RED 1 = 0V
RED 2 = UNCORRELATED SINEWAVE
 $R_L = 150\Omega$, 10pF SCOPE PROBE

1675 G19

Slew Rate

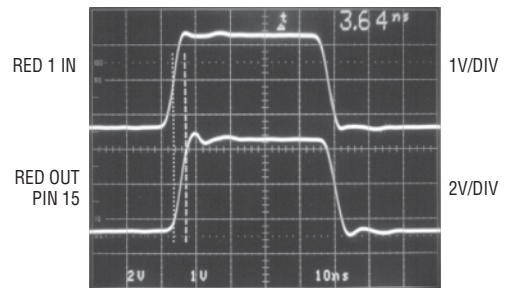

MEASURED AT PIN 15
 $R_L = 150\Omega$, 10pF SCOPE PROBE
SR = 1100V/ μ s

1675 G20

Small-Signal Rise Time

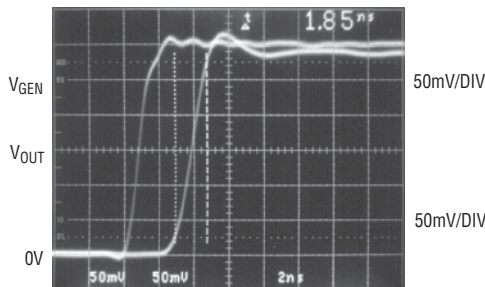

$R_L = 100\Omega$
MEASURED WITH FET PROBES

1675 G21

Enable and Disable

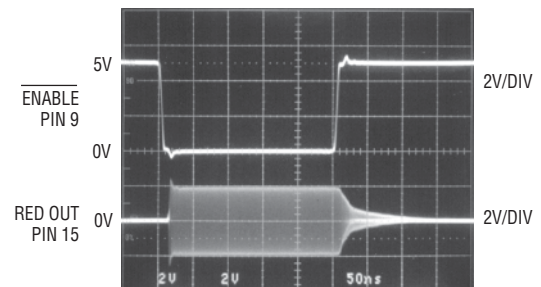

ENABLE AND DISABLE OF UNCORRELATED SINEWAVE
 $R_L = 150\Omega$

1675 G22

PIN FUNCTIONS

LT1675

RED 1 (Pin 1): Red 1 Input. The 1V video input signal to be switched is applied to this pin. If 2V is applied to this pin, $V_{OUT\ RED}$ will clip. The input must be terminated.

GREEN 1 (Pin 2): Green 1 Input. The 1V video input signal to be switched is applied to this pin. If 2V is applied to this pin, $V_{OUT\ GREEN}$ will clip. The input must be terminated.

BLUE 1 (Pin 3): Blue 1 Input. The 1V video input signal to be switched is applied to this pin. If 2V is applied to this pin, $V_{OUT\ BLUE}$ will clip. The input must be terminated.

GND (Pins 4, 5): Signal Ground. Connect to ground plane.

RED 2 (Pin 6): Red 2 Input. The 1V video input signal to be switched is applied to this pin. If 2V is applied to this pin, $V_{OUT\ RED}$ will clip. The input must be terminated.

GREEN 2 (Pin 7): Green 2 Input. The 1V video input signal to be switched is applied to this pin. If 2V is applied to this pin, $V_{OUT\ GREEN}$ will clip. The input must be terminated.

BLUE 2 (Pin 8): Blue 2 Input. The 1V video input signal to be switched is applied to this pin. If 2V is applied to this pin, $V_{OUT\ BLUE}$ will clip. The input must be terminated.

ENABLE (Pin 9): Chip Enable. Ground this pin for normal operation. Take this pin to within 300mV of V^+ , or open to shut down the part. This pin is also used for router applications. When the part is disabled, the supply current is 1 μ A.

LT1675-1

V_{IN1} (Pin 1): The 1V video input signal to be switched is applied to this pin. If 2V is applied to this pin, V_{OUT} will clip. The input must be terminated.

GND (Pin 2): Signal Ground. Connect to ground plane.

V_{IN2} (Pin 3): The 1V video input signal to be switched is applied to this pin. If 2V is applied to this pin, V_{OUT} will clip. The input must be terminated.

V^- (Pin 4): Connect this pin to $-5V$ and bypass with good tantalum capacitor (4.7 μ F). The pin may also require a 0.1 μ F or 0.01 μ F depending on layout.

SELECT (Pin 5): Use this pin to select V_{IN1} or V_{IN2} . Use this pin for fast toggling. HIGH Selects V_{IN1} .

SELECT (Pin 10): Channel Select. Use this pin to select between RGB1 inputs and RGB2 inputs. Use this pin for fast toggling. HIGH Selects RGB1.

V^- (Pins 11, 12): Negative Power Supply. Connect these pins to $-5V$ and bypass with a good tantalum capacitor (4.7 μ F). The pin may also require a 0.1 μ F or 0.01 μ F depending on layout.

$V_{OUT\ BLUE}$ (Pin 13): Blue Output. It is twice BLUE 1 or BLUE 2 depending on which channel is selected by Pin 10. $V_{OUT\ BLUE}$ drives 50 Ω or 75 Ω double-terminated cables. Do not add capacitance to this pin.

$V_{OUT\ GREEN}$ (Pin 14): Green Output. It is twice GREEN 1 or GREEN 2 depending on which channel is selected by Pin 10. $V_{OUT\ GREEN}$ drives 50 Ω or 75 Ω double-terminated cables. Do not add capacitance to this pin.

$V_{OUT\ RED}$ (Pin 15): Red Output. It is twice RED 1 or RED 2 depending on which channel is selected by Pin 10. $V_{OUT\ RED}$ drives 50 Ω or 75 Ω double-terminated cables. Do not add capacitance to this pin.

V^+ (Pin 16): Positive Power Supply. Connect this pin to 5V and bypass with a good tantalum capacitor (4.7 μ F). The pin may also require a 0.1 μ F or 0.01 μ F depending on layout.

V_{OUT} (Pin 6): It is twice V_{IN1} or V_{IN2} depending on which channel is selected by Pin 5. V_{OUT} drives 50 Ω or 75 Ω double-terminated cables. Do not add capacitance to this pin.

ENABLE (Pin 7): Ground this pin for normal operation. Take this pin to within 300mV of V^+ , or open to shut down the part. This pin is also used for router applications. When the part is disabled, the supply current is 0.3 μ A.

V^+ (Pin 8): Connect this pin to 5V and bypass with a good tantalum capacitor (4.7 μ F). The pin may also require a 0.1 μ F or 0.01 μ F depending on layout.

APPLICATIONS INFORMATION

Power Supplies

The LT1675 will function with supply voltages below $\pm 2V$ (4V total), however, to ensure a full $1V_{P-P}$ video signal ($2V_{P-P}$ at the output pins), the power supply voltage should be between $\pm 4V$ to $\pm 6V$. The LT1675 is designed to operate on $\pm 5V$, and at no time should the supplies exceed $\pm 6V$. The power supplies should be bypassed with quality tantalum capacitors. It may be necessary to add a $0.01\mu F$ or $0.1\mu F$ in parallel with the tantalum capacitors if there is excessive ringing on the output waveform. Even though the LT1675 is well behaved, bypass capacitors should be placed as close to the LT1675 as possible.

Smallest Package and PC Board Space

The LT1675 has the internal gain set for $+2V/V$ or 6dB, because it is designed to drive a double-terminated 50Ω or 75Ω cable that has an inherent 6dB loss. There are several advantages to setting the gain internally. This topology eliminates six gain set resistors, reduces the pin count of the package and eliminates stray capacitance on the sensitive feedback node. The LT1675 fits into the small

SSOP package, and these advantages lead to the smallest PC board footprint with enhanced performance. The LT1675-1 eliminates two gain set resistors and is available in the tiny MSOP package and the cost-effective SO-8 package.

Fast Switching

The key to the LT1675 fast switching speed is Linear Technology's proprietary high speed bipolar process. Internal switches can change state in less than 1ns, but the output of the MUX switches in about 2.5ns, as shown in Figure 1. The additional delay is due to the finite bandwidth and the slew rate of the current feedback amplifier that drives the cable.

For minimum ringing, it is important to minimize the load capacitance on the output of the part. This is normally not a problem in a controlled impedance environment, but stray PC board capacitance and scope probe capacitance can degrade the pulse fidelity. Figure 2 shows the response of the output to various capacitive loads measured with a 10pF scope probe.



Figure 1. Toggling at 25MHz



Figure 2. Response to Capacitive Loads

APPLICATIONS INFORMATION

Switching Transients

This MUX includes fast current steering break-before-make SPDT switches that minimize switching glitches. The switching transients of Figure 3 are input-referred (measured between 75Ω back termination and the 75Ω load). The glitch is only 50mV_{p-p} and the duration is just 5ns. This transient is small and fast enough to not be visible on quality graphics terminals. Additionally, the break-before-make SPDT switch is open before the alternate channel is connected. This means there is no input feedthrough during switching. Figure 4 shows the amount of alternate channel that is coupled at the input.

Expanding Inputs

In video routing applications where the ultimate speed is not mandatory, as it is in pixel switching, it is possible to expand the number of MUX inputs by shorting the LT1675 outputs together and switching with the ENABLE pins. The internal gain set resistors have a nominal value of 750Ω and cause a 1500Ω shunt across the 75Ω cable termination. Figure 5 shows schematically the effect of expanding the number of inputs. The effect of this loading is to cause a gain error that can be calculated by the following formula:

$$\text{Gain Error (dB)} = 6\text{dB} + 20\log\left(\frac{\frac{1575\Omega}{n-1} \parallel 75\Omega}{75 + \frac{1575\Omega}{n-1} \parallel 75\Omega}\right) \text{dB}$$

where n is total number of LT1675s. For example, using ten LT1675s (20 Red, 20 Green and 20 Blue) the Gain Error is only -1.7dB per channel.

Figure 6 shows a 4-input RGB router. The response from RED 1 Input to Red Output is shown in Figure 7 for a 25MHz square wave with Chip Select = 0V. In this case the Gain Error is -0.23dB. Toggling with Chip Select between IC #1 and IC #2 is shown in Figure 8. In this case RED 1 Input is connected to 0V and RED 3 Input is connected to an uncorrelated sinewave.

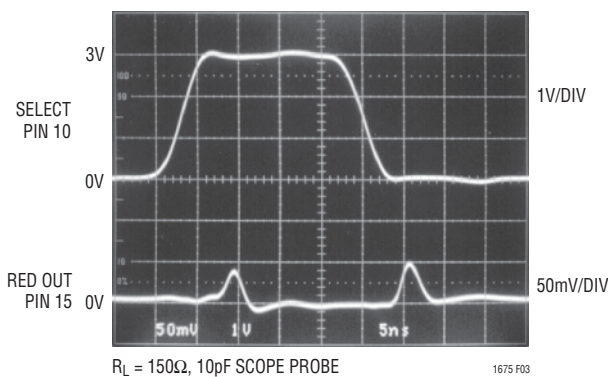

Figure 3. Input-Referred Switching Transient

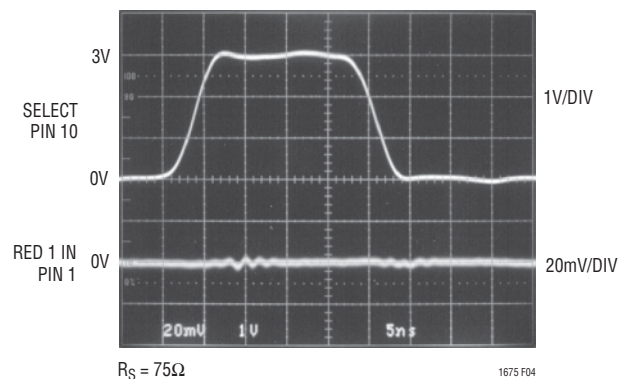

Figure 4. Switching Transient at RED 1 (Pin 1)

APPLICATIONS INFORMATION



Figure 5. Off Channels Load the Cable Termination with 1575Ω Each



Figure 6. Two LT1675s Build a 4-Input RGB Router



Figure 7. 4-Input Router Response

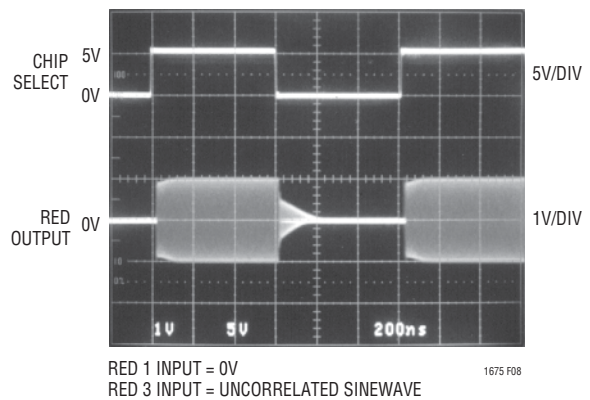
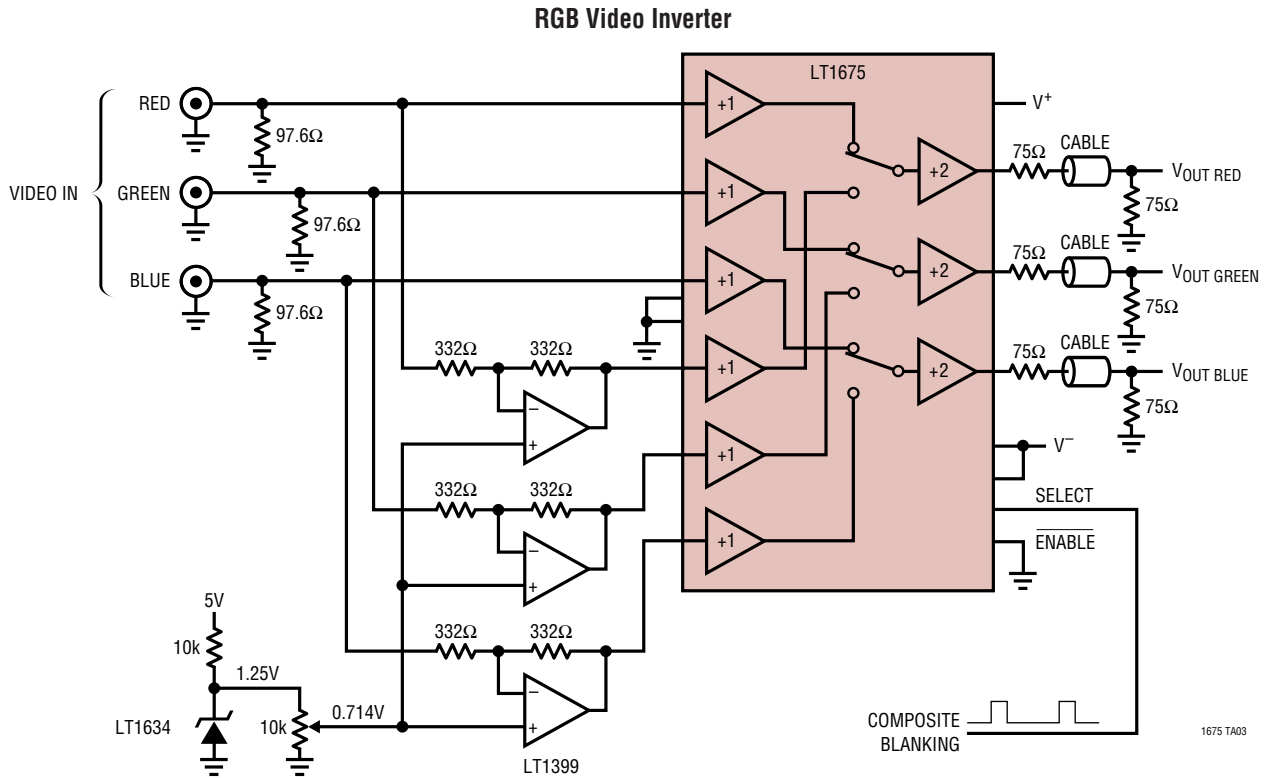

Figure 8. 4-Input Router Toggling

TYPICAL APPLICATIONS



This circuit is useful for viewing photographic negatives on video. A single channel can be used for composite or monochrome video. The inverting amplifier stages are only switched in during active video so the blanking, sync

and color burst (if present) are not disturbed. To prevent video from swinging negative, a voltage offset equal to the peak video signal is added to the inverted signal.

TYPICAL APPLICATIONS

Logo or “Bug” Inserter

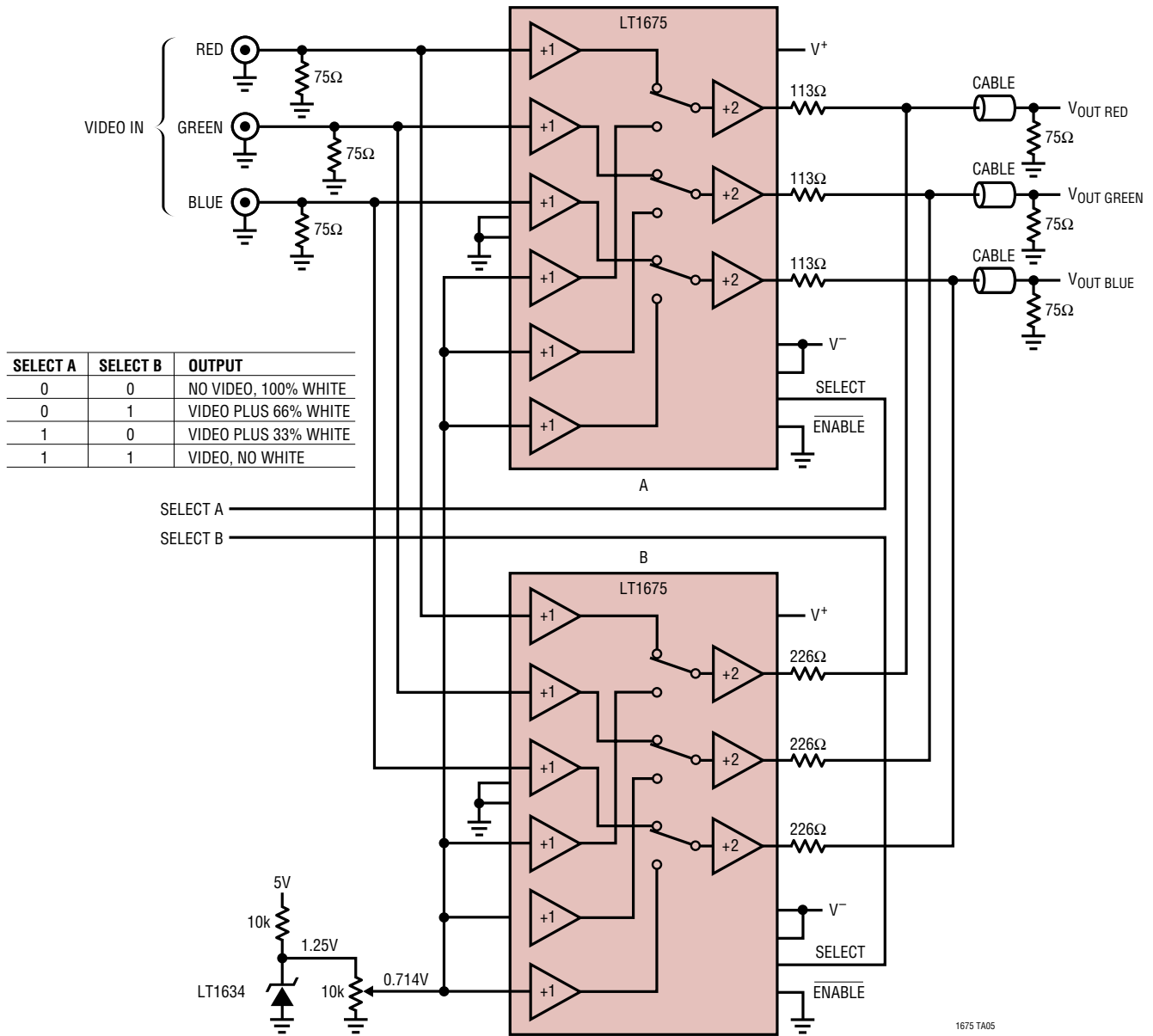

This circuit highlights a section of the picture under control of a synchronous key signal. It can be used for adding the logo (also called a “bug”) you see in the bottom corner of commercial television pictures or any sort of overlay signal, such as a crosshair or a reticule. The key signal has 2 bits of control so there can be four levels of highlighting: unmodified video, video plus 33% white, video plus 66% white and 100% white. The two LT1675s are configured as a 2-bit DAC. The resistors on the outputs

set the relative bit weights. The output of the LT1675 labeled B in the schematic is one half the weight of the A device. To properly match the 75Ω video cable, the output resistors are selected so the parallel combination of the two is 75 ohms. The output will never exceed peak white, which is 0.714V for this NTSC-related RGB video. The reference white signal is adjustable to lower than peak white to make the effect less intrusive, if desired.

1675 TA05

SIMPLIFIED SCHEMATIC (LT1675-1, LT1675 One Channel)

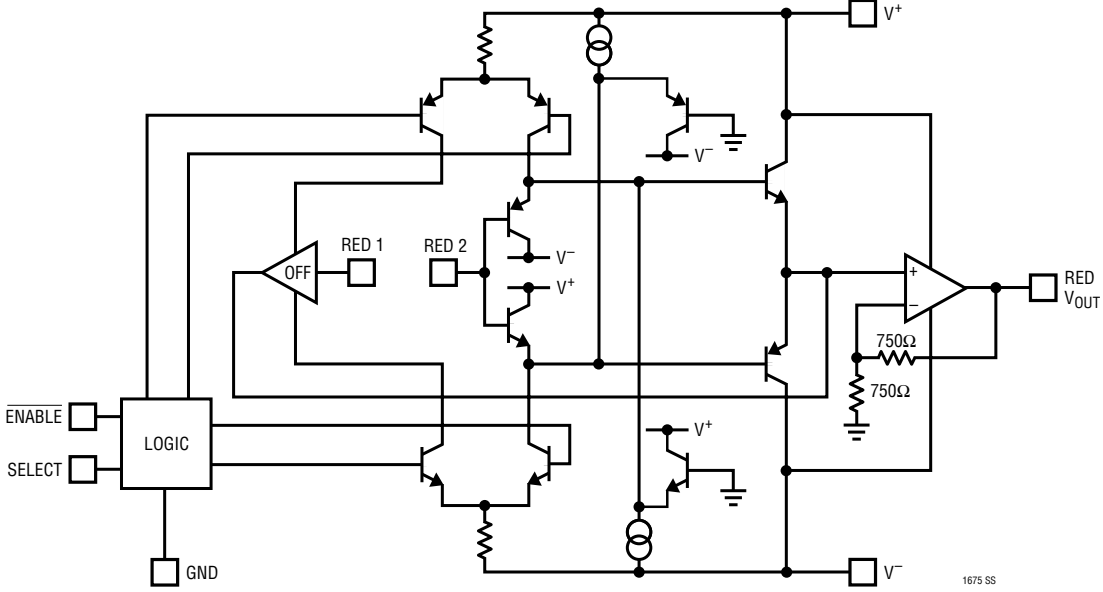

PACKAGE DESCRIPTION

Dimensions in inches (millimeters) unless otherwise noted.

GN Package
16-Lead Plastic SSOP (Narrow 0.150)
 (LTC DWG # 05-08-1641)

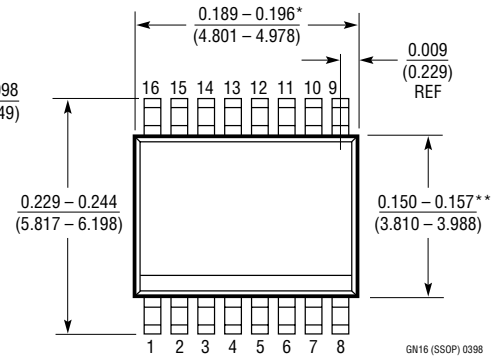

* DIMENSION DOES NOT INCLUDE MOLD FLASH. MOLD FLASH SHALL NOT EXCEED 0.006" (0.152mm) PER SIDE
 ** DIMENSION DOES NOT INCLUDE INTERLEAD FLASH. INTERLEAD FLASH SHALL NOT EXCEED 0.010" (0.254mm) PER SIDE

GN16 (SSOP) 0398

MS8 Package
8-Lead Plastic MSOP
 (LTC DWG # 05-08-1660)

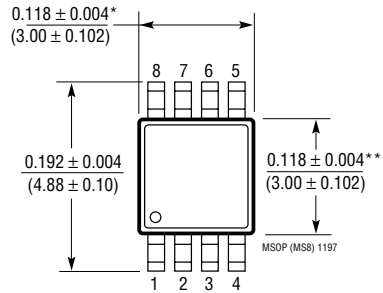
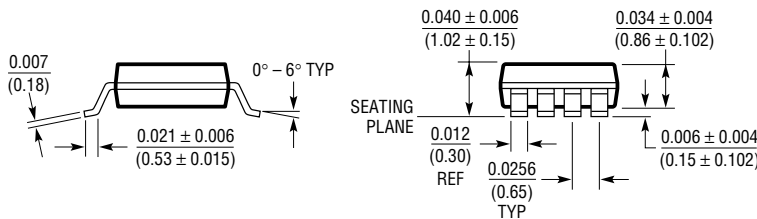

* DIMENSION DOES NOT INCLUDE MOLD FLASH, PROTRUSIONS OR GATE BURRS. MOLD FLASH, PROTRUSIONS OR GATE BURRS SHALL NOT EXCEED 0.006" (0.152mm) PER SIDE
 ** DIMENSION DOES NOT INCLUDE INTERLEAD FLASH OR PROTRUSIONS. INTERLEAD FLASH OR PROTRUSIONS SHALL NOT EXCEED 0.006" (0.152mm) PER SIDE

MSOP (MS8) 1197

S8 Package
8-Lead Plastic Small Outline (Narrow 0.150)
 (LTC DWG # 05-08-1610)

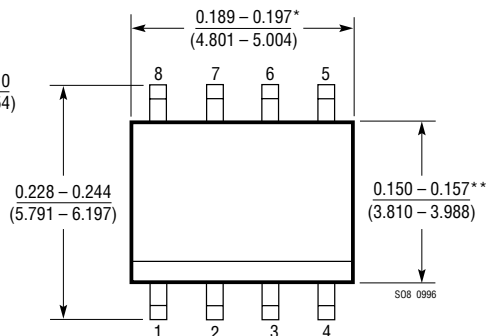
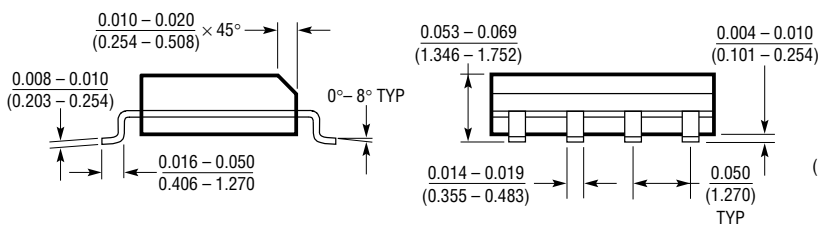

* DIMENSION DOES NOT INCLUDE MOLD FLASH. MOLD FLASH SHALL NOT EXCEED 0.006" (0.152mm) PER SIDE
 ** DIMENSION DOES NOT INCLUDE INTERLEAD FLASH. INTERLEAD FLASH SHALL NOT EXCEED 0.010" (0.254mm) PER SIDE

S08 0996