

## FEATURES

- 3.8nV/√Hz Input Noise Voltage
- 3.7mA Supply Current
- 200MHz Gain Bandwidth
- Low Total Harmonic Distortion: –85dBc at 1MHz
- 70V/μs Slew Rate
- 400μV Maximum Input Offset Voltage
- 300nA Maximum Input Bias Current
- Unity-Gain Stable
- Capacitive Load Stable Up to 100pF
- 23mA Minimum Output Current
- Specified at ±5V and Single 5V
- Low Profile (1mm) SOT-23 (ThinSot™) Package

## APPLICATIONS

- Video and RF Amplification
- ADSL, HDSL II, VDSL Receivers
- Active Filters
- Wideband Amplifiers
- Buffers
- Data Acquisition Systems

LT, LT, LTC, LTM, Linear Technology and the Linear logo are registered trademarks of Linear Technology Corporation. ThinSOT is a trademark of Linear Technology Corporation. All other trademarks are the property of their respective owners.

## DESCRIPTION

The LT®1722/LT1723/LT1724 are single/dual/quad, low noise, low power, high speed operational amplifiers. These products feature lower input offset voltage, lower input bias current and higher DC gain than devices with comparable bandwidth. The 200MHz gain bandwidth ensures high open-loop gain at video frequencies.

The low input noise voltage is achieved with reduced supply current. The total noise is optimized for a source resistance between 0.8k and 12k. Due to the input bias current cancellation technique used, the resistance seen by each input does not need to be balanced.

The output drives a 150Ω load to ±3V with ±5V supplies. On a single 5V supply the output swings from 1.5V to 3.5V with a 500Ω load connected to 2.5V. The amplifier is unity-gain stable ( $C_{LOAD} \leq 100\text{pF}$ ).

The LT1722/LT1723/LT1724 are manufactured on Linear Technology's advanced low voltage complementary bipolar process. The LT1722 is available in the SO-8 and 5-pin SOT-23 packages. The LT1723 is available in the SO-8 and MS8 packages. The LT1724 is available in the 14-lead SO package.

## TYPICAL APPLICATION

Differential Video Line Driver



Line Driver Multiburst Video Signal



# LT1722/LT1723/LT1724

## ABSOLUTE MAXIMUM RATINGS

(Note 1)

Total Supply Voltage ( $V^+$  to  $V^-$ ) ..... 12.6V  
 Input Voltage.....  $\pm V_S$   
 Differential Input Voltage (Note 2) .....  $\pm 0.7V$   
 Input Current (Note 2).....  $\pm 10mA$   
 Output Short-Circuit Duration (Note 3) ..... Indefinite

Operating Temperature Range (Note 4) ...  $-40^\circ C$  to  $85^\circ C$   
 Specified Temperature Range (Note 5) ....  $-40^\circ C$  to  $85^\circ C$   
 Maximum Junction Temperature .....  $150^\circ C$   
 Storage Temperature Range .....  $-65^\circ C$  to  $150^\circ C$   
 Lead Temperature (Soldering, 10 sec).....  $300^\circ C$

## PIN CONFIGURATION



## ORDER INFORMATION

LEAD FREE FINISH	TAPE AND REEL	PART MARKING*	PACKAGE DESCRIPTION	SPECIFIED TEMPERATURE RANGE
LT1722CS8#PBF	LT1722CS8#TRPBF	1722	8-Lead Plastic SO	0°C to 70°C
LT1722IS8#PBF	LT1722IS8#TRPBF	1722I	8-Lead Plastic SO	-40°C to 85°C
LT1722CS5#PBF	LT1722CS5#TRPBF	LTZB	5-Lead Plastic TSOT-23	0°C to 70°C
LT1722IS5#PBF	LT1722IS5#TRPBF	LTZB	5-Lead Plastic TSOT-23	-40°C to 85°C
LT1723CS8#PBF	LT1723CS8#TRPBF	1723	8-Lead Plastic SO	0°C to 70°C
LT1723IS8#PBF	LT1723IS8#TRPBF	1723I	8-Lead Plastic SO	-40°C to 85°C
LT1723CMS8#PBF	LT1723CMS8#TRPBF	LTYC	8-Lead Plastic MSOP	0°C to 70°C
LT1723IMS8#PBF	LT1723IMS8#TRPBF	LTZA	8-Lead Plastic MSOP	-40°C to 85°C
LT1724CS#PBF	LT1724CS#TRPBF	LT1724CS	14-Lead Plastic SO	0°C to 70°C
LT1724IS#PBF	LT1724IS#TRPBF	LT1724IS	14-Lead Plastic SO	-40°C to 85°C

Consult LTC Marketing for parts specified with wider operating temperature ranges. \*The temperature grade is identified by a label on the shipping container. Consult LTC Marketing for information on non-standard lead based finish parts.

For more information on lead free part marking, go to: <http://www.linear.com/leadfree/>

For more information on tape and reel specifications, go to: <http://www.linear.com/tapeandreeel/>

# LT1722/LT1723/LT1724

## ELECTRICAL CHARACTERISTICS $T_A = 25^\circ\text{C}$ , $V_S = \pm 5\text{V}$ , $V_{CM} = 0\text{V}$ , unless otherwise noted.

SYMBOL	PARAMETER	CONDITIONS	MIN	TYP	MAX	UNITS
$V_{OS}$	Input Offset Voltage	(Note 6) LT1722 SOT-23 and LT1723 MS8		100 150	400 650	$\mu\text{V}$ $\mu\text{V}$
$I_{OS}$	Input Offset Current			40	300	nA
$I_B$	Input Bias Current			40	300	nA
$e_n$	Input Noise Voltage	$f = 10\text{kHz}$		3.8		$\text{nV}/\sqrt{\text{Hz}}$
$i_n$	Input Noise Current	$f = 10\text{kHz}$		1.2		$\text{pA}/\sqrt{\text{Hz}}$
$R_{IN}$	Input Resistance	$V_{CM} = \pm 3.5\text{V}$ Differential	5	35 50		$\text{M}\Omega$ $\text{k}\Omega$
$C_{IN}$	Input Capacitance			2		pF
	Input Voltage Range + Input Voltage Range –		3.5	4 –4	–3.5	V V
CMRR	Common Mode Rejection Ratio	$V_{CM} = \pm 3.5\text{V}$	80	100		dB
PSRR	Power Supply Rejection Ratio	$V_S = \pm 2.3\text{V}$ to $\pm 5.5\text{V}$	78	90		dB
$A_{VOL}$	Large-Signal Voltage Gain	$V_{OUT} = \pm 3\text{V}$ , $R_L = 500\Omega$ $V_{OUT} = \pm 3\text{V}$ , $R_L = 150\Omega$	10 7	17 14		V/mV V/mV
$V_{OUT}$	Output Swing	$R_L = 500\Omega$ , $V_{IN} = \pm 10\text{mV}$ $R_L = 150\Omega$ , $V_{IN} = \pm 10\text{mV}$	$\pm 3.2$ $\pm 3.1$	$\pm 3.8$ $\pm 3.4$		V V
$I_{OUT}$	Output Current	$V_{OUT} = \pm 3\text{V}$ , 10mV Overdrive	23	50		mA
$I_{SC}$	Short-Circuit Current	$V_{OUT} = 0\text{V}$ , $V_{IN} = \pm 1\text{V}$	35	90		mA
SR	Slew Rate	$A_V = -1$ , (Note 7)	45	70		V/ $\mu\text{s}$
	Full Power Bandwidth	3V Peak, (Note 8)		3.7		MHz
GBW	Gain Bandwidth	$f = 200\text{kHz}$	115	200		MHz
$t_S$	Settling Time	$A_V = -1$ , 2V, 0.1% $A_V = -1$ , 2V, 0.01%		91 112		ns ns
$t_r$ , $t_f$	Rise Time, Fall Time	$A_V = 1$ , 10% to 90%, $V_{IN} = 0.2\text{V}_{P-P}$ , $R_L = 150\Omega$		6		ns
	Overshoot	$A_V = 1$ , $V_{IN} = 0.2\text{V}_{P-P}$ , $R_L = 150\Omega$ , $R_F = 0\Omega$		15		%
	Propagation Delay	50% $V_{IN}$ to 50% $V_{OUT} = 0.2\text{V}_{P-P}$ , $R_L = 150\Omega$		3		ns
$R_O$	Output Resistance	$A_V = 1$ , $f = 1\text{MHz}$		0.15		$\Omega$
	Channel Separation	$V_{OUT} = \pm 3\text{V}$ , $R_L = 150\Omega$	82	90		dB
$I_S$	Supply Current	Per Amplifier		3.7	4.5	mA

$T_A = 25^\circ\text{C}$ ,  $V_S = 5\text{V}$ ,  $V_{CM} = 2.5\text{V}$ ,  $R_L$  to 2.5V, unless otherwise noted.

$V_{OS}$	Input Offset Voltage	(Note 6) LT1722 SOT-23 and LT1723 MS8		250 350	550 800	$\mu\text{V}$ $\mu\text{V}$
$I_{OS}$	Input Offset Current			20	300	nA
$I_B$	Input Bias Current			20	300	nA
$e_n$	Input Noise Voltage	$f = 10\text{kHz}$		4		$\text{nV}/\sqrt{\text{Hz}}$
$i_n$	Input Noise Current	$f = 10\text{kHz}$		1.1		$\text{pA}/\sqrt{\text{Hz}}$
$R_{IN}$	Input Resistance	$V_{CM} = 1.5\text{V}$ to $3.5\text{V}$ Differential	5	32 55		$\text{M}\Omega$ $\text{k}\Omega$
$C_{IN}$	Input Capacitance			2		pF
	Input Voltage Range + Input Voltage Range –		3.5	4 1	1.5	V V

**ELECTRICAL CHARACTERISTICS**  $T_A = 25^\circ\text{C}$ .  $V_S = 5\text{V}$ ,  $V_{CM} = 2.5\text{V}$ ,  $R_L$  to  $2.5\text{V}$ , unless otherwise noted.

SYMBOL	PARAMETER	CONDITIONS	MIN	TYP	MAX	UNITS
CMRR	Common Mode Rejection Ratio	$V_{CM} = 1.5\text{V}$ to $3.5\text{V}$	80	100		dB
$A_{VOL}$	Large-Signal Voltage Gain	$V_{OUT} = 1.5\text{V}$ to $3.5\text{V}$ , $R_L = 500\Omega$	4	10		V/mV
$V_{OUT}$	Output Swing+ Output Swing-	$R_L = 500\Omega$ , $V_{IN} = \pm 10\text{mV}$ $R_L = 500\Omega$ , $V_{IN} = \pm 10\text{mV}$	3.6	3.8 0.9	1.4	V V
$I_{OUT}$	Output Current	$V_{OUT} = 3.5\text{V}$ or $1.5\text{V}$ , $10\text{mV}$ Overdrive	10	20		mA
$I_{SC}$	Short-Circuit Current	$V_{OUT} = 2.5\text{V}$ , $V_{IN} = \pm 1\text{V}$	22	55		mA
SR	Slew Rate	$A_V = -1$ , (Note 7)	40	70		V/ $\mu\text{s}$
	Full Power Bandwidth	1V Peak, (Note 8)		8.7		MHz
GBW	Gain Bandwidth (Note 10)	$f = 200\text{kHz}$	115	180		MHz
$t_r$ , $t_f$	Rise Time, Fall Time	$A_V = 1$ , 10% to 90%, $V_{IN} = 0.2\text{V}_{P-P}$ , $R_L = 500\Omega$		5		ns
	Overshoot	$A_V = 1$ , $V_{IN} = 0.2\text{V}_{P-P}$ , $R_L = 500\Omega$		16		%
	Propagation Delay	50% $V_{IN}$ to 50% $V_{OUT}$ , $0.1\text{V}$ , $R_L = 500\Omega$		3		ns
$R_O$	Output Resistance	$A_V = 1$ , $f = 1\text{MHz}$		0.19		$\Omega$
	Channel Separation	$V_{OUT} = 1.5\text{V}$ to $3.5\text{V}$ , $R_L = 500\Omega$	82	90		dB
$I_S$	Supply Current	Per Amplifier		3.8	5	mA

The ● denotes the specifications which apply over the temperature range of  $0^\circ\text{C} \leq T_A \leq 70^\circ\text{C}$ .  $V_S = \pm 5\text{V}$ ,  $V_{CM} = 0\text{V}$ , unless otherwise noted. (Note 5)

SYMBOL	PARAMETER	CONDITIONS	MIN	TYP	MAX	UNITS
$V_{OS}$	Input Offset Voltage	(Note 6) LT1722 SOT-23 and LT1723 MS8			700 850	$\mu\text{V}$ $\mu\text{V}$
	Input $V_{OS}$ Drift	(Note 9)		3	7	$\mu\text{V}/^\circ\text{C}$
$I_{OS}$	Input Offset Current				350	nA
$I_B$	Input Bias Current				350	nA
	Input Voltage Range + Input Voltage Range -		3.5		-3.5	V V
CMRR	Common Mode Rejection Ratio	$V_{CM} = \pm 3.5\text{V}$	●	75		dB
PSRR	Power Supply Rejection Ratio	$V_S = \pm 2.3\text{V}$ to $\pm 5.5\text{V}$	●	76		dB
$A_{VOL}$	Large-Signal Voltage Gain	$V_{OUT} = \pm 3\text{V}$ , $R_L = 500\Omega$ $V_{OUT} = \pm 3\text{V}$ , $R_L = 150\Omega$	● ●	9 6		V/mV V/mV
$V_{OUT}$	Output Swing	$R_L = 500\Omega$ , $V_{IN} = \pm 10\text{mV}$ $R_L = 150\Omega$ , $V_{IN} = \pm 10\text{mV}$	● ●	$\pm 3.15$ $\pm 3.05$		V V
$I_{OUT}$	Output Current	$V_{OUT} = \pm 3\text{V}$ , $10\text{mV}$ Overdrive	●	22		mA
$I_{SC}$	Short-Circuit Current	$V_{OUT} = 0\text{V}$ , $V_{IN} = \pm 1\text{V}$	●	30		mA
SR	Slew Rate	$A_V = -1$ , (Note 7)	●	35		V/ $\mu\text{s}$
GBW	Gain Bandwidth	$f = 200\text{kHz}$	●	100		MHz
	Channel Separation	$V_{OUT} = \pm 3\text{V}$ , $R_L = 150\Omega$	●	81		dB
$I_S$	Supply Current	Per Amplifier	●		5.45	mA

# LT1722/LT1723/LT1724

## ELECTRICAL CHARACTERISTICS

The ● denotes the specifications which apply over the temperature range of  $0^{\circ}\text{C} \leq T_A \leq 70^{\circ}\text{C}$ .  $V_S = 5\text{V}$ ,  $V_{CM} = 2.5\text{V}$ ,  $R_L$  to  $2.5\Omega$ , unless otherwise noted. (Note 5)

SYMBOL	PARAMETER	CONDITIONS	MIN	TYP	MAX	UNITS
$V_{OS}$	Input Offset Voltage	(Note 6) LT1722 SOT-23 and LT1723 MS8	●		850 950	$\mu\text{V}$ $\mu\text{V}$
	Input $V_{OS}$ Drift	(Note 9)	●	3	7	$\mu\text{V}/^{\circ}\text{C}$
$I_{OS}$	Input Offset Current		●		350	nA
$I_B$	Input Bias Current		●		350	nA
	Input Voltage Range +		●	3.5		V
	Input Voltage Range -		●		1.5	V
CMRR	Common Mode Rejection Ratio	$V_{CM} = 1.5\text{V}$ to $3.5\text{V}$	●	75		dB
$A_{VOL}$	Large-Signal Voltage Gain	$V_{OUT} = 1.5\text{V}$ to $3.5\text{V}$ , $R_L = 500\Omega$	●	3		V/mV
$V_{OUT}$	Output Swing+	$R_L = 500\Omega$ , $V_{IN} = \pm 10\text{mV}$	●	3.55		V
	Output Swing-	$R_L = 500\Omega$ , $V_{IN} = \pm 10\text{mV}$	●		1.45	V
$I_{OUT}$	Output Current	$V_{OUT} = 3.5\text{V}$ , or $1.5\text{V}$ , $10\text{mV}$ Overdrive	●	9		mA
$I_{SC}$	Short-Circuit Current	$V_{OUT} = 2.5\text{V}$ , $V_{IN} = \pm 1\text{V}$	●	11		mA
SR	Slew Rate	$A_V = -1$ , (Note 7)	●	30		V/ $\mu\text{s}$
GBW	Gain Bandwidth (Note 10)	$f = 200\text{kHz}$	●	100		MHz
	Channel Separation	$V_{OUT} = 1.5\text{V}$ to $3.5\text{V}$ , $R_L = 500\Omega$	●	81		dB
$I_S$	Supply Current		●		5.95	mA

The ● denotes the specifications which apply over the temperature range of  $-40^{\circ}\text{C} \leq T_A \leq 85^{\circ}\text{C}$ .  $V_S = \pm 5\text{V}$ ,  $V_{CM} = 0\text{V}$ , unless otherwise noted. (Note 5)

SYMBOL	PARAMETER	CONDITIONS	MIN	TYP	MAX	UNITS
$V_{OS}$	Input Offset Voltage	(Note 6) LT1722 SOT-23 and LT1723 MS8	●		900 1100	$\mu\text{V}$ $\mu\text{V}$
	Input $V_{OS}$ Drift	(Note 9)	●	3	10	$\mu\text{V}/^{\circ}\text{C}$
$I_{OS}$	Input Offset Current		●		400	nA
$I_B$	Input Bias Current		●		400	nA
	Input Voltage Range +		●	3.5		V
	Input Voltage Range -		●		-3.5	V
CMRR	Common Mode Rejection Ratio	$V_{CM} = \pm 3.5\text{V}$	●	75		dB
PSRR	Power Supply Rejection Ratio	$V_S = \pm 2.0\text{V}$ to $\pm 5.5\text{V}$	●	75		dB
$A_{VOL}$	Large-Signal Voltage Gain	$V_{OUT} = \pm 3\text{V}$ , $R_L = 500\Omega$	●	8		V/mV
		$V_{OUT} = \pm 3\text{V}$ , $R_L = 150\Omega$	●	5		V/mV
$V_{OUT}$	Output Swing	$R_L = 500\Omega$ , $V_{IN} = \pm 10\text{mV}$	●	$\pm 3.1$		V
		$R_L = 150\Omega$ , $V_{IN} = \pm 10\text{mV}$	●	$\pm 3.0$		V
$I_{OUT}$	Output Current	$V_{OUT} = \pm 3\text{V}$ , $10\text{mV}$ Overdrive	●	20		mA
$I_{SC}$	Short-Circuit Current	$V_{OUT} = 0\text{V}$ , $V_{IN} = \pm 1\text{V}$	●	25		mA
SR	Slew Rate	$A_V = -1$ , (Note 7)	●	25		V/ $\mu\text{s}$
GBW	Gain Bandwidth	$f = 200\text{kHz}$	●	90		MHz
	Channel Separation	$V_{OUT} = \pm 3\text{V}$ , $R_L = 150\Omega$	●	80		dB
$I_S$	Supply Current		●		5.95	mA

## ELECTRICAL CHARACTERISTICS

The ● denotes the specifications which apply over the temperature range of  $-40^{\circ}\text{C} \leq T_A \leq 85^{\circ}\text{C}$ .  $V_S = 5\text{V}$ ,  $V_{CM} = 2.5\text{V}$ ,  $R_L$  to 2.5V, unless otherwise noted. (Note 5)

SYMBOL	PARAMETER	CONDITIONS	MIN	TYP	MAX	UNITS
$V_{OS}$	Input Offset Voltage	(Note 6)	●		1000	$\mu\text{V}$
		LT1722 SOT-23 and LT1723 MS8	●		1200	$\mu\text{V}$
	Input $V_{OS}$ Drift	(Note 9)	●	3	10	$\mu\text{V}/^{\circ}\text{C}$
$I_{OS}$	Input Offset Current		●		400	nA
$I_B$	Input Bias Current		●		400	nA
		Input Voltage Range + Input Voltage Range -	● ●	3.5	1.5	V V
CMRR	Common Mode Rejection Ratio	$V_{CM} = 1.5\text{V}$ to 3.5V	●	75		dB
$A_{VOL}$	Large-Signal Voltage Gain	$V_{OUT} = 1.5\text{V}$ to 3.5V, $R_L = 500\Omega$	●	2		V/mV
$V_{OUT}$	Output Swing+ Output Swing-	$R_L = 500\Omega$ , $V_{IN} = \pm 10\text{mV}$	●	3.5		V
		$R_L = 500\Omega$ , $V_{IN} = \pm 10\text{mV}$	●		1.5	V
$I_{OUT}$	Output Current	$V_{OUT} = 3.5\text{V}$ or 1.5V, 30mV Overdrive	●	8		mA
$I_{SC}$	Short-Circuit Current	$V_{OUT} = 2.5\text{V}$ , $V_{IN} = \pm 1\text{V}$	●	10		mA
SR	Slew Rate	$A_V = -1$ , (Note 7)	●	20		V/ $\mu\text{s}$
GBW	Gain Bandwidth (Note 10)	$f = 200\text{kHz}$	●	90		MHz
		Channel Separation	●	80		dB
$I_S$	Supply Current		●		6.45	mA

**Note 1:** Stresses beyond those listed under Absolute Maximum Ratings may cause permanent damage to the device. Exposure to any Absolute Maximum Rating condition for extended periods may affect device reliability and lifetime.

**Note 2:** The inputs are protected by back-to-back diodes. If the differential input voltage exceeds 0.7V, the input current should be limited to less than 10mA.

**Note 3:** A heat sink may be required to keep the junction temperature below the absolute maximum rating when the output is shorted indefinitely.

**Note 4:** The LT1722C/LT1722I, LT1723C/LT1723I, LT1724C/LT1724I are guaranteed functional over the operating temperature range of  $-40^{\circ}\text{C}$  to  $85^{\circ}\text{C}$ .

**Note 5:** The LT1722C/LT1723C/LT1724C are guaranteed to meet specified performance from  $0^{\circ}\text{C}$  to  $70^{\circ}\text{C}$ . The LT1722C/LT1723C/LT1724C are

designed, characterized and expected to meet specified performance from  $-40^{\circ}\text{C}$  to  $85^{\circ}\text{C}$  but are not tested or QA sampled at these temperatures. The LT1722I/LT1723I/LT1724I are guaranteed to meet specified performance from  $-40^{\circ}\text{C}$  to  $85^{\circ}\text{C}$ .

**Note 6:** Input offset voltage is pulse tested and is exclusive of warm-up drift.

**Note 7:** Slew rate is measured between  $\pm 2\text{V}$  on the output with  $\pm 3\text{V}$  input for  $\pm 5\text{V}$  supplies and  $\pm 1\text{V}$  on the output with  $\pm 1.5\text{V}$  input for single 5V supply. (For 5V supply, the voltage levels are 2.5V referred.)

**Note 8:** Full power bandwidth is calculated from the slew rate:  

$$\text{FPBW} = \text{SR}/2\pi V_P$$

**Note 9:** This parameter is not 100% tested.

**Note 10:** This parameter is guaranteed through correlation with slew rate.

## TYPICAL PERFORMANCE CHARACTERISTICS

**Supply Current vs Temperature**

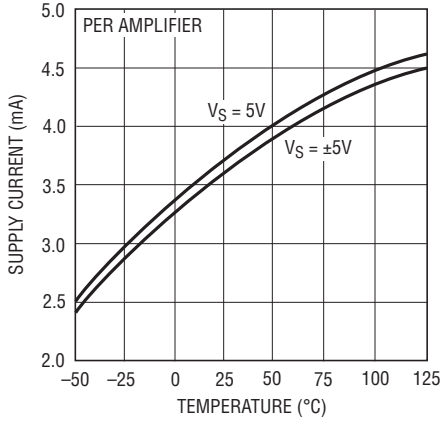

1723 G01

**Input Common Mode Range vs Supply Voltage**

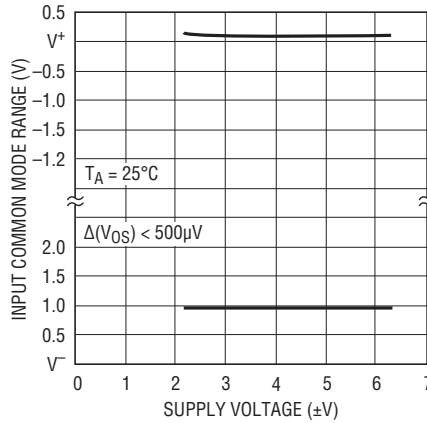

1723 G02

**Input Bias Current vs Common Mode Voltage**

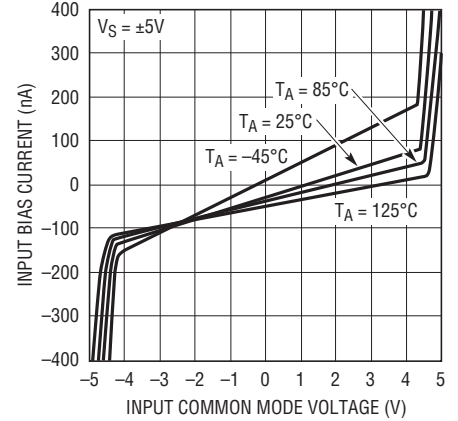

1723 G03

**Input Bias Current vs Temperature**

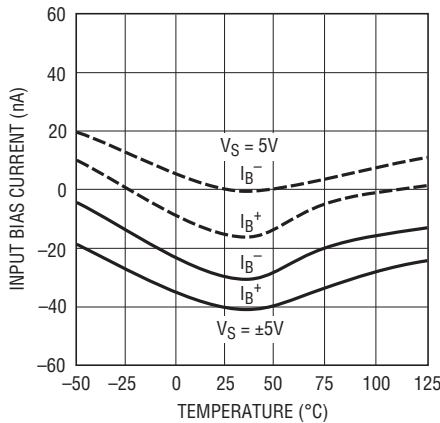

1723 G04

**Input Noise Spectral Density**

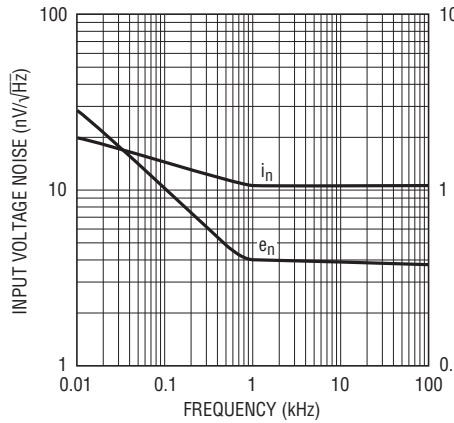

1723 G05

**Open-Loop Gain vs Resistive Load**

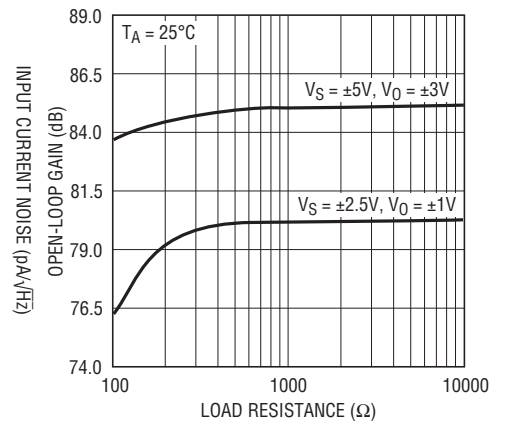

1723 G06

**Total Noise vs Unmatched Source Resistance**

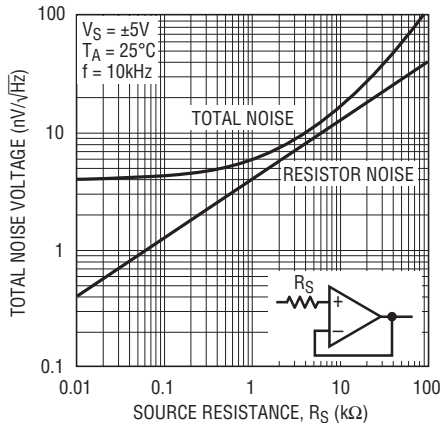

1723 G07

**Warm-Up Drift vs Time**

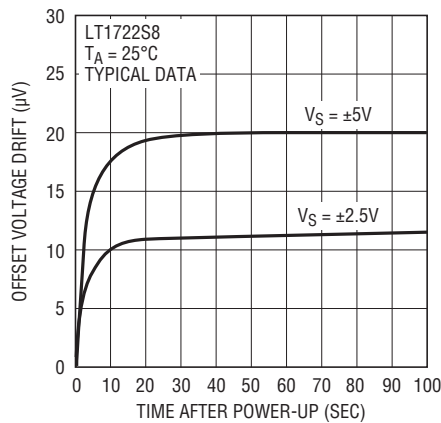

1723 G08

**VOS Shift vs VCM and VS**

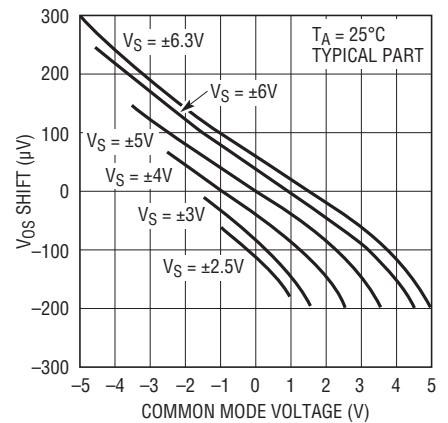

1723 G09



# TYPICAL PERFORMANCE CHARACTERISTICS

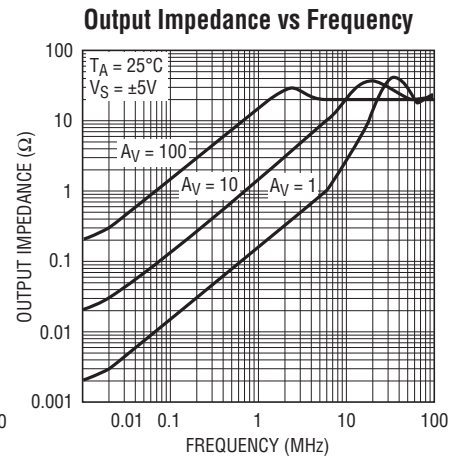
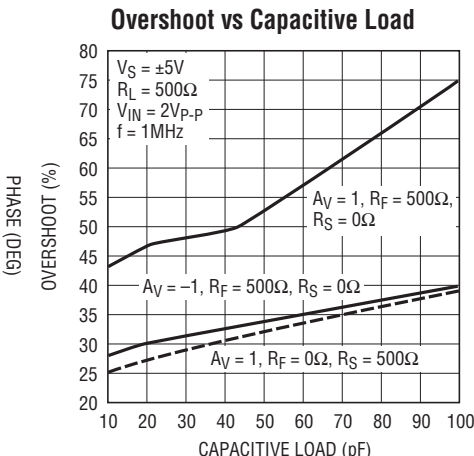
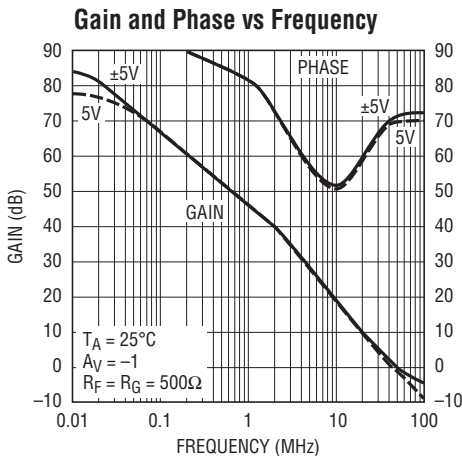
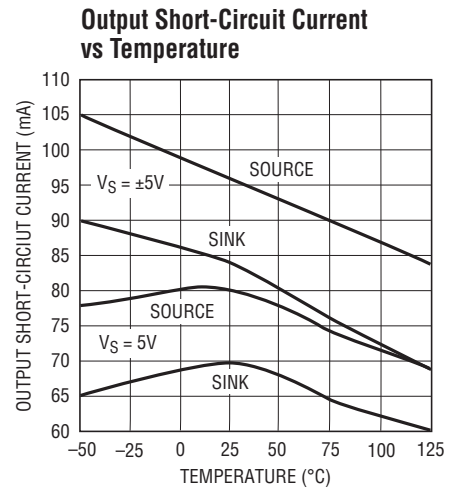
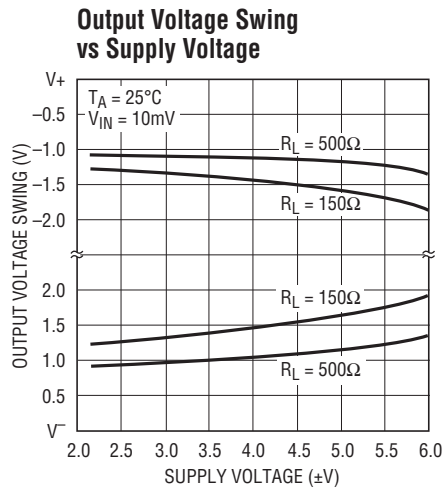
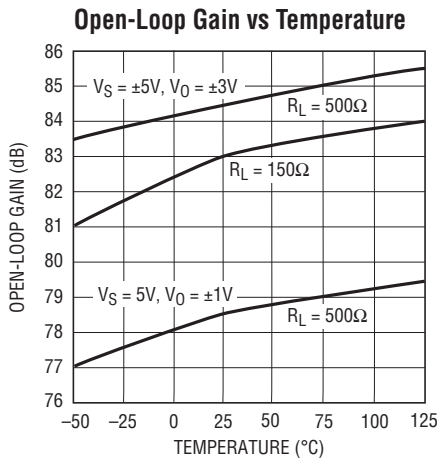
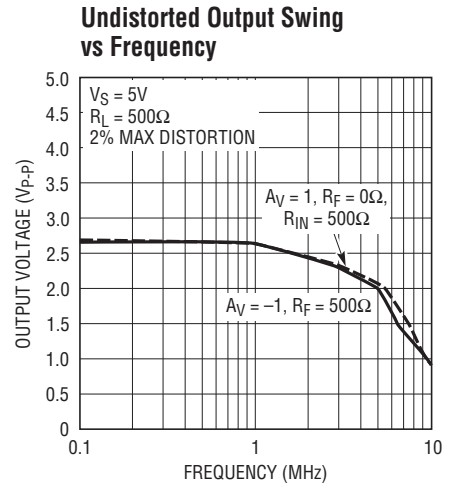
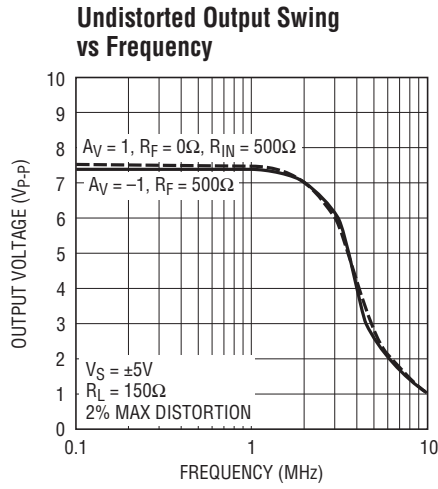
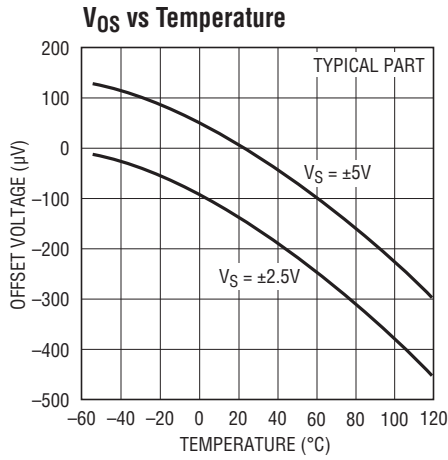

TYPICAL PERFORMANCE CHARACTERISTICS

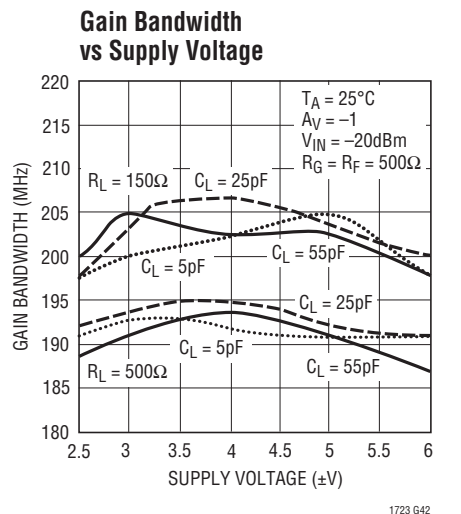
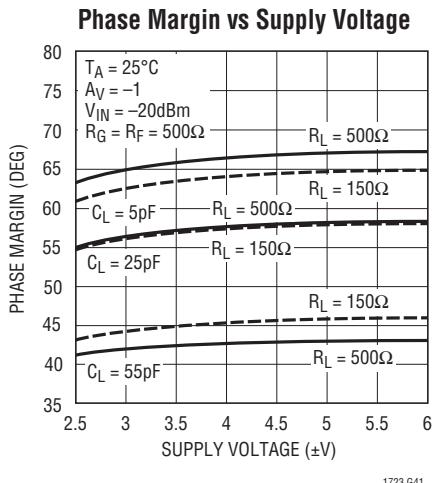
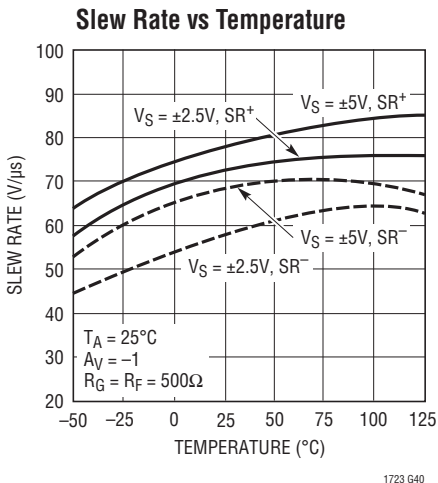
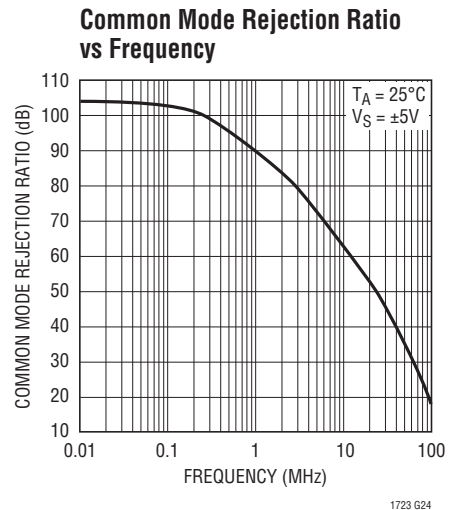
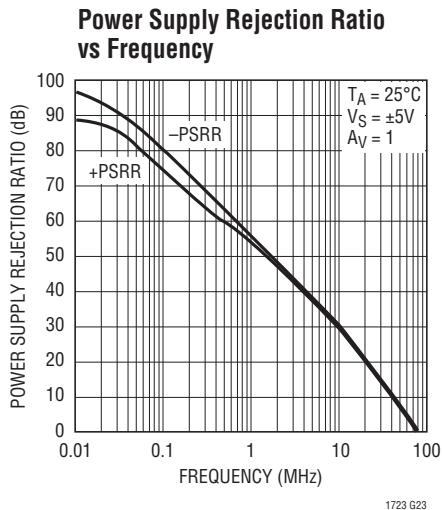
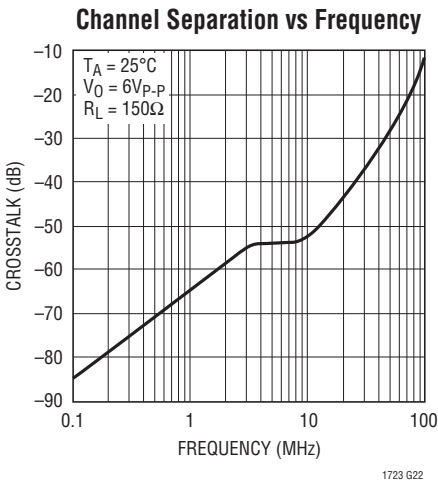
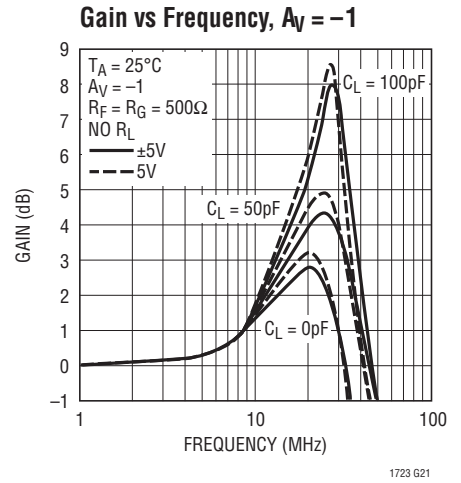
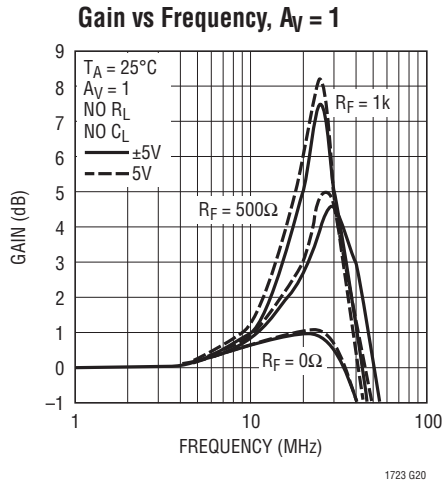
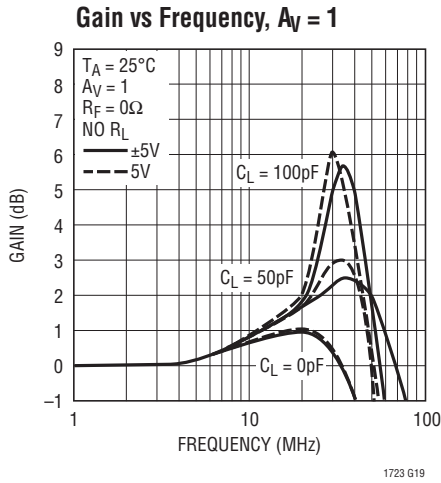

# TYPICAL PERFORMANCE CHARACTERISTICS

**Slew Rate vs Supply Voltage**



1723 G25

**Harmonic Distortion vs Frequency**  
 $A_V = 1, V_0 = 0.2V_{P-P}$

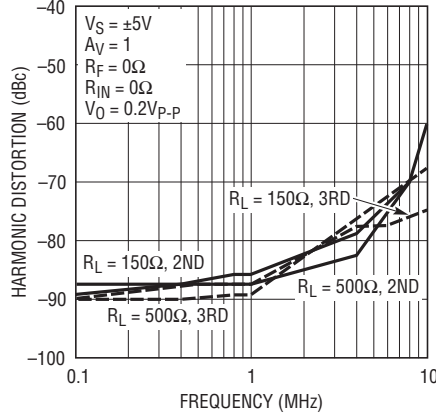

1723 G26

**Harmonic Distortion vs Frequency**  
 $A_V = 1, V_0 = 0.2V_{P-P}$

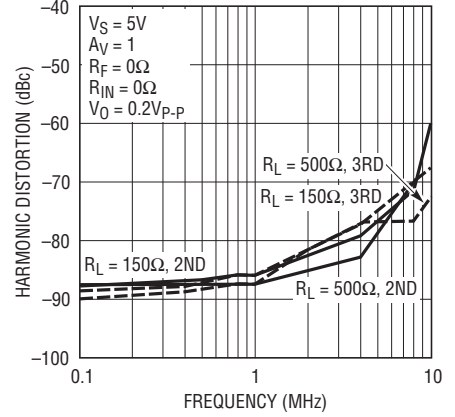

1723 G27

**Harmonic Distortion vs Frequency**  
 $A_V = 2, V_0 = 0.2V_{P-P}$

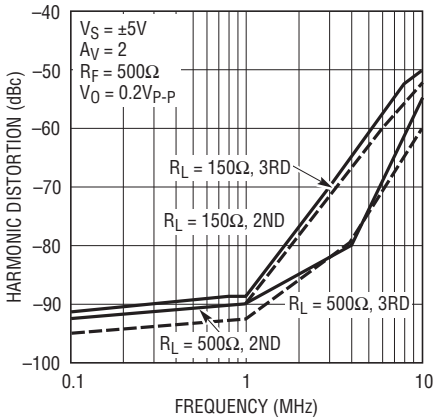

1723 G28

**Harmonic Distortion vs Frequency**  
 $A_V = 2, V_0 = 0.2V_{P-P}$

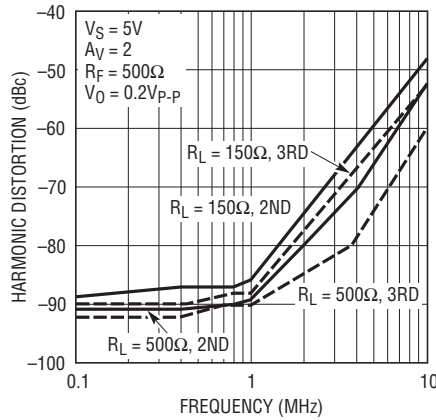

1723 G29

**Harmonic Distortion vs Frequency**  
 $A_V = 1, V_0 = 2V_{P-P}$

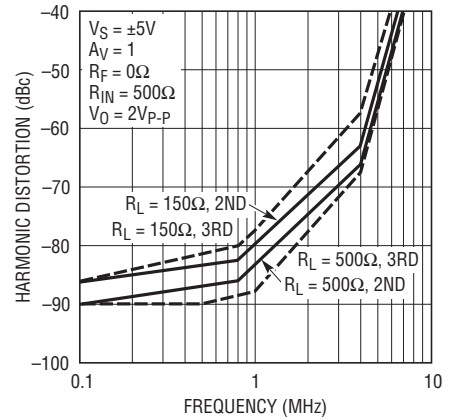

1723 G30

**Harmonic Distortion vs Frequency**  
 $A_V = 1, V_0 = 2V_{P-P}$

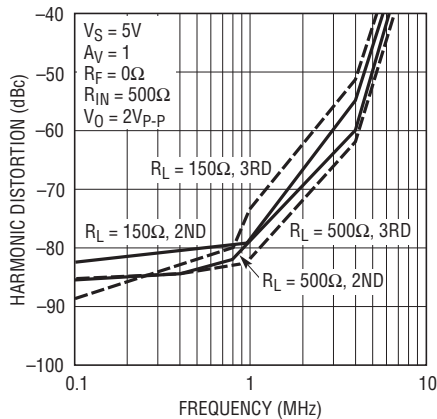

1723 G31

**Harmonic Distortion vs Frequency**  
 $A_V = 2, V_0 = 2V_{P-P}$

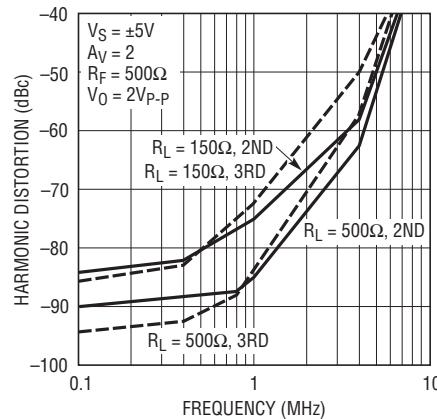

1723 G32

## TYPICAL PERFORMANCE CHARACTERISTICS



**Large-Signal Transient,  $A_V = 1$**

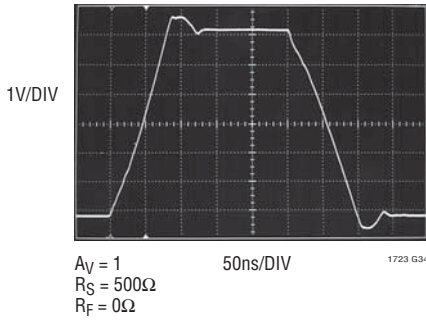

**Small-Signal Transient,  $A_V = 1$**

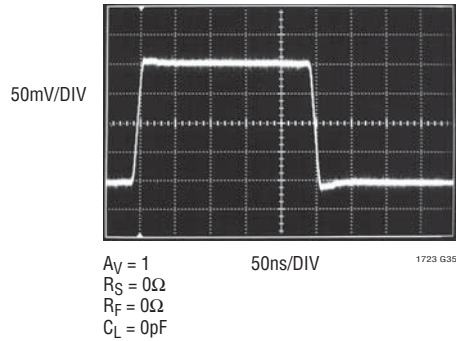

**Small-Signal Transient,  $A_V = 1$**

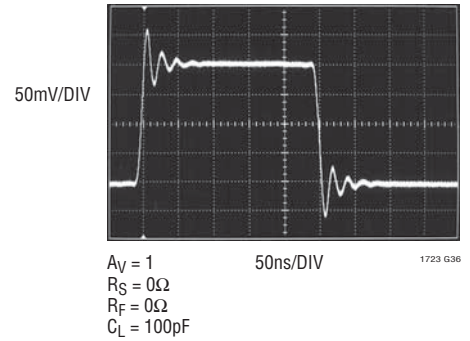

**Large-Signal Transient,  $A_V = -1$**



**Small-Signal Transient,  $A_V = -1$**



**Small-Signal Transient,  $A_V = -1$**

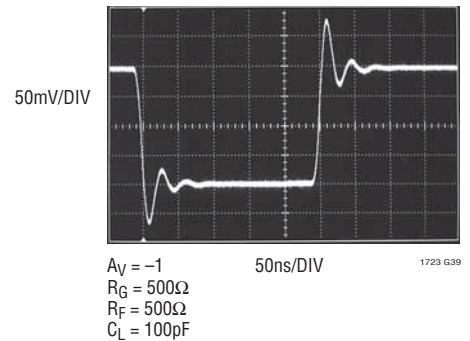

## APPLICATIONS INFORMATION

The LT1722/LT1723/LT1724 may be inserted directly into many operational amplifier applications improving both DC and AC performance, as well as noise and distortion.

### Layout and Passive Components

The LT1722/LT1723/LT1724 amplifiers are more tolerant of less than ideal layouts than other high speed amplifiers. For maximum performance (for example, fast settling time) use a ground plane, short lead lengths and RF quality bypass capacitors (0.01μF to 0.1μF). For high drive current applications, use low ESR supply bypass capacitors (1μF to 10μF tantalum). The output/input parasitic coupling should be minimized when high frequency performance is required.

The parallel combination of the feedback resistor and gain setting resistor on the inverting input combine with the input capacitance to form a pole that can cause peaking or even oscillations. In parallel with the feedback resistor, a capacitor of value:

$$C_F > R_G \cdot C_{IN}/R_F$$

should be used to cancel the input pole and optimize dynamic performance. For unity-gain applications where a feedback resistor is used, such as an I-to-V converter,  $C_F$  should be five times greater than  $C_{IN}$ ; an optimum value for  $C_F$  is 10pF.

### Input Considerations

Each of the LT1722/LT1723/LT1724 inputs is protected with back-to-back diodes across the bases of the NPN input devices. If greater than 0.7V differential input voltages are anticipated, the input current must be limited to less than 10mA with an external series resistor. Each input also has two ESD clamp diodes—one to each supply. If an input is driven beyond the supply, limit the current with an external resistor to less than 10mA. The input stage protection circuit is shown in Figure 1.

The input currents of the LT1722/LT1723/LT1724 are typically in the tens of nA range due to the bias current cancellation technique used at the input. As the input offset current can be greater than either input current,



Figure 1. Input Stage Protection

adding resistance to balance source resistance is not recommended. The value of the source resistor should be below 12k as it actually degrades DC accuracy and also increases noise.

### Total Input Noise

The total input noise of the LT1722/LT1723/LT1724 is optimized for a source resistance between 0.8k and 12k. Within this range, the total input noise is dominated by the noise of the source resistance itself. When the source resistance is below 0.8k, voltage noise of the amplifier dominates. When the source resistance is above 12k, the input noise current is the dominant contributor.

### Capacitive Loading

The LT1722/LT1723/LT1724 drive capacitive loads up to 100pF with unity gain. As the capacitive load increases, both the bandwidth and the phase margin decrease causing peaking in the frequency response and overshoot in the transient response. When there is a need to drive a larger capacitive load, a 25Ω series resistance assures stability with any value of load capacitor. A feedback capacitor also helps to reduce any peaking.

### Power Dissipation

The LT1722/LT1723/LT1724 combine high speed and large output drive in a small package. Maximum junction temperature ( $T_J$ ) is calculated from the ambient temperature ( $T_A$ ), power dissipation per amplifier ( $P_D$ ) and number of amplifiers ( $n$ ) as follows:

$$T_J = T_A + (n \cdot P_D \cdot \theta_{JA})$$

## APPLICATIONS INFORMATION

Power dissipation is composed of two parts. The first is due to the quiescent supply current and the second is due to on-chip dissipation caused by the load current.

Worst-case instantaneous power dissipation for a given resistive load in one amplifier occurs at the maximum supply current and when the output voltage is at half of either supply voltage (or the maximum swing if less than half supply voltage).

Therefore  $P_{D(MAX)}$  in one amplifier is:

$$P_{D(MAX)} = (V^+ - V^-)(I_{S(MAX)}) + (V^+/2)^2/R_L$$

or

$$P_{D(MAX)} = (V^+ - V^-)(I_{S(MAX)}) + (V^+ - V_{O(MAX)})(V_{O(MAX)}/R_L)$$

Example. Worst-case conditions are: both op amps in the LT1723IS8 are at  $T_A = 85^\circ\text{C}$ ,  $V_S = \pm 5\text{V}$ ,  $R_L = 150\Omega$ ,  $V_{OUT} = 2.5\text{V}$ .

$$P_{D(MAX)} = 2 \cdot [(10\text{V})(5.95\text{mA}) + (2.5\text{V})^2/150\Omega] = 203\text{mW}$$

$$T_{J(MAX)} = 85^\circ\text{C} + (203\text{mW})(190^\circ\text{C/W}) = 124^\circ\text{C}$$

which is less than the absolute maximum rating at  $150^\circ\text{C}$ .

## Circuit Operation

The LT1722/LT1723/LT1724 circuit topology is a voltage feedback amplifier. The operation of the circuit can be understood by referring to the Simplified Schematic. The first stage is a folded cascode formed by the transistors Q1 through Q4. A degeneration resistor, R, is used in the input stage. The current mirror Q5, Q6 is bootstrapped by Q7. The capacitor, C, assures the bandwidth and the slew rate performance. The output stage is formed by complementary emitter followers, Q8 through Q11. The diodes D1 and D2 protect against input reversed biasing. The remaining part of the circuit assures optimum voltage and current biases for all stages.

Low noise, reduced current supply, high speed and DC accurate parameters are distinctive features of the LT1722/LT1723/LT1724.

## SIMPLIFIED SCHEMATIC



**PACKAGE DESCRIPTION**

**S5 Package**  
**5-Lead Plastic TSOT-23**  
 (Reference LTC DWG # 05-08-1635)

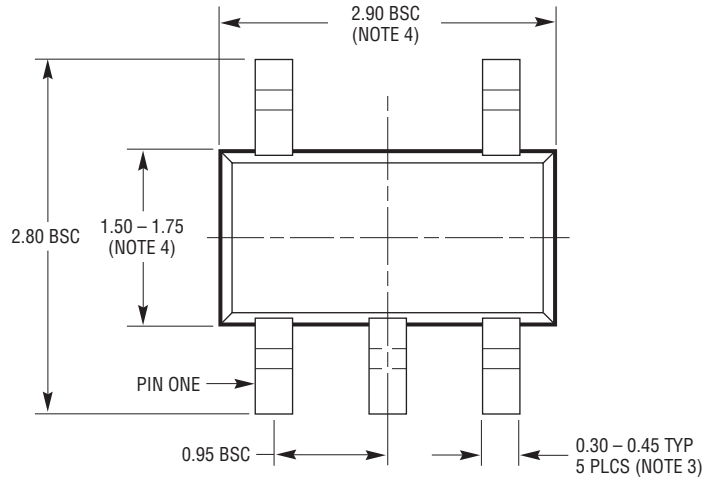

- NOTE:
1. DIMENSIONS ARE IN MILLIMETERS
  2. DRAWING NOT TO SCALE
  3. DIMENSIONS ARE INCLUSIVE OF PLATING
  4. DIMENSIONS ARE EXCLUSIVE OF MOLD FLASH AND METAL BURR
  5. MOLD FLASH SHALL NOT EXCEED 0.254mm
  6. JEDEC PACKAGE REFERENCE IS MO-193

S5 TSOT-23 0302 REV B



## PACKAGE DESCRIPTION

### S8 Package 8-Lead Plastic Small Outline (Narrow .150 Inch) (Reference LTC DWG # 05-08-1610)

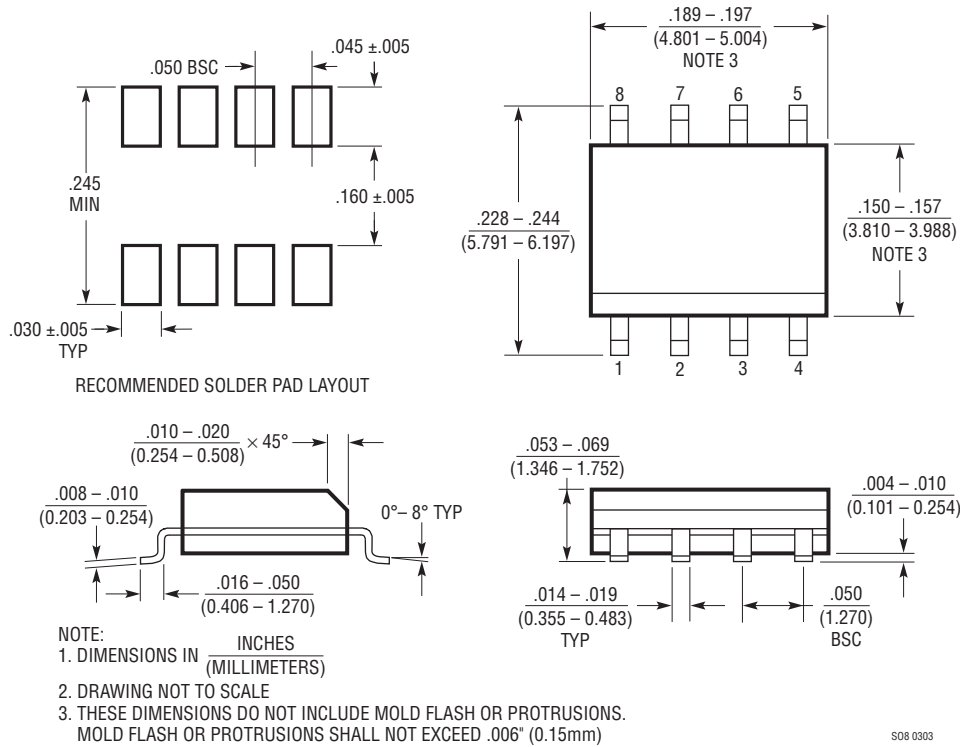

### MS8 Package 8-Lead Plastic MSOP (Reference LTC DWG # 05-08-1660 Rev F)

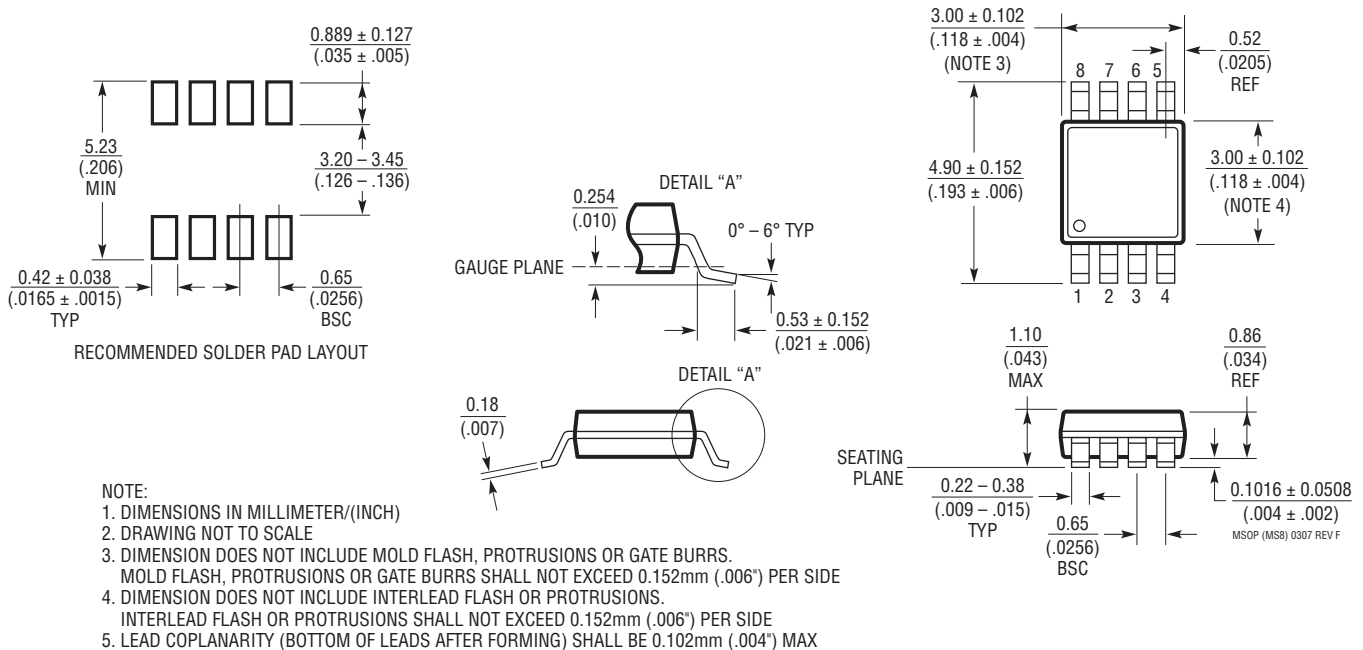



**PACKAGE DESCRIPTION**

**S Package**  
**14-Lead Plastic Small Outline (Narrow .150 Inch)**  
 (Reference LTC DWG # 05-08-1610)

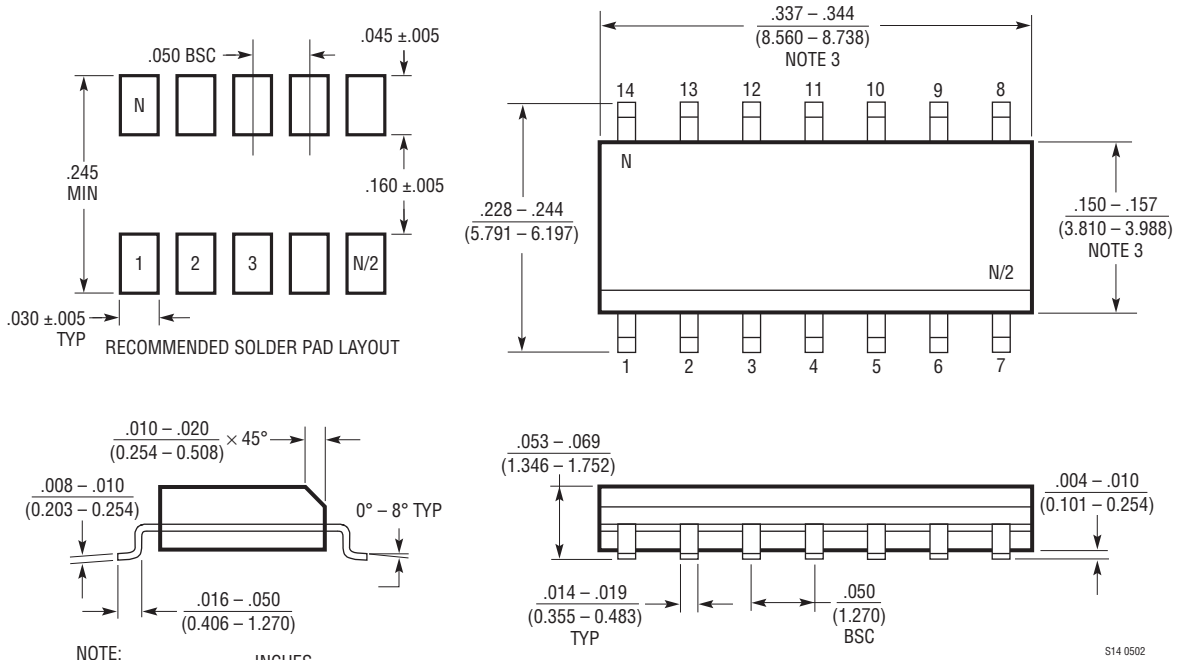

- NOTE:  
 1. DIMENSIONS IN INCHES (MILLIMETERS)  
 2. DRAWING NOT TO SCALE  
 3. THESE DIMENSIONS DO NOT INCLUDE MOLD FLASH OR PROTRUSIONS. MOLD FLASH OR PROTRUSIONS SHALL NOT EXCEED .006" (0.15mm)

S14 0502