

1.5A, Low Noise, Negative Linear Regulator with Precision Current Limit

FEATURES

- **Output Current: 1.5A**
- **Dropout Voltage: 310mV**
- **Precision Current Limit with Foldback**
- **Low Output Noise: 60 μ V_{RMS} (10Hz to 100kHz)**
- **Low Quiescent Current: 1.1mA**
- **Precision Positive or Negative Shutdown Logic**
- **Fast Transient Response**
- **Wide Input Voltage Range: -1.8V to -30V**
- **Adjustable Output Voltage Range: -1.22V to -29.3V**
- **Fixed Output Voltages: -2.5V, -3V, -3.3V, -5V, -12V, -15V**
- **Controlled Quiescent Current in Dropout**
- **<1 μ A Quiescent Current in Shutdown**
- **Stable with 10 μ F Output Capacitor**
- **Stable with Ceramic, Tantalum or Aluminum Capacitors**
- **Thermal Limit with Hysteresis**
- **Reverse Output Protection**
- **5-Lead TO-220 and DD-Pak, Thermally Enhanced 12-Lead MSOP and 8-Lead 3mm \times 3mm \times 0.75mm DFN Packages**

APPLICATIONS

- Post-Regulator for Switching Supplies
- Negative Logic Supplies
- Low Noise Instrumentation
- Industrial Supplies
- Negative Complement to the LT1963A

DESCRIPTION

The LT[®]3015 series are low noise, low dropout, negative linear regulators with fast transient response. The devices supply up to 1.5A of output current at a typical dropout voltage of 310mV. Operating quiescent current is typically 1.1mA and drops to < 1 μ A in shutdown. Quiescent current is also well controlled in dropout. In addition to fast transient response, the LT3015 series exhibit very low output noise, making them ideal for noise sensitive applications.

The LT3015 regulators are stable with a minimum 10 μ F output capacitor. Moreover, the regulator can use small ceramic capacitors without the necessary addition of ESR as is common with other regulators. Internal protection circuitry includes reverse output protection, precision current limit with foldback and thermal limit with hysteresis.

The LT3015 regulators are available in fixed output voltages of -2.5V, -3V, -3.3V, -5V, -12V and -15V and as an adjustable device with a -1.22V reference voltage. Packages include the 5-lead TO-220 and DD-Pak, a thermally enhanced 12-lead MSOP and the low profile (0.75 mm) 8-lead 3mm \times 3mm DFN.

LT, LT, LTC, LTM, Linear Technology and the Linear Logo are registered trademarks and ThinSOT is a trademark of Linear Technology Corporation. All other trademarks are the property of their respective owners.

TYPICAL APPLICATION

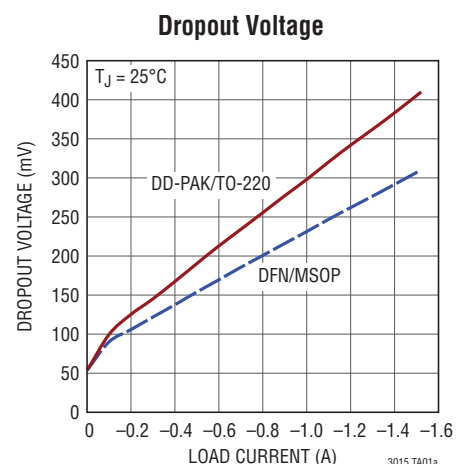
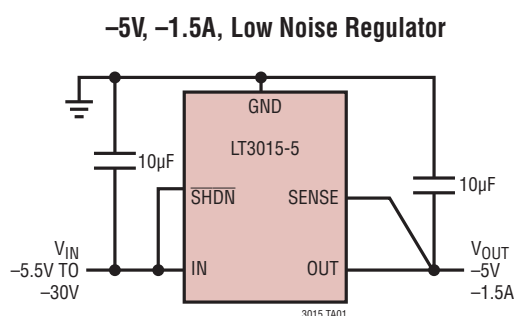

LT3015 Series

ABSOLUTE MAXIMUM RATINGS

(Note 1)

IN Pin Voltage	±33V
OUT Pin Voltage (Note 10)	±33V
OUT to IN Differential Voltage (Note 10)	-0.3V, 33V
SENSE Pin Voltage (with Respect to IN Pin) (Note 10)	-0.3V, 33V
ADJ Pin Voltage (with Respect to IN Pin) (Note 10)	-0.3V, 33V
SHDN Pin Voltage (with Respect to IN Pin) (Note 10)	-0.3V, 55V

SHDN Pin Voltage

(with Respect to GND Pin) -33V, 22V

Output Short-Circuit Duration Indefinite

Operating Junction Temperature Range (Note 9)

E-, I-Grade -40°C to 125°C

MP-Grade -55°C to 125°C

Storage Temperature Range -65°C to 150°C

Lead Temperature (Soldering, 10Sec)

MS12E Package 300°C

Q, T Packages 250°C

PIN CONFIGURATION

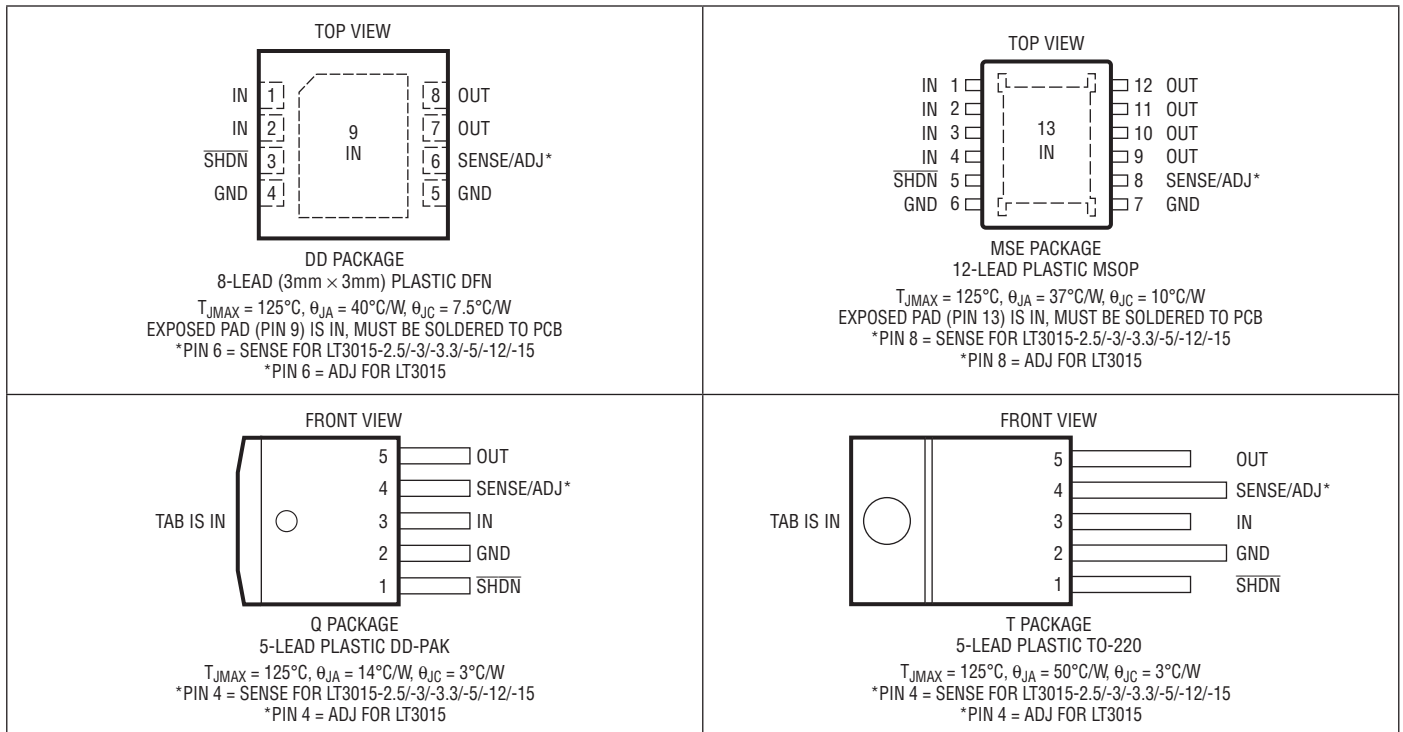

ORDER INFORMATION

LEAD FREE FINISH	TAPE AND REEL	PART MARKING*	PACKAGE DESCRIPTION	TEMPERATURE RANGE
LT3015EDD#PBF	LT3015EDD#TRPBF	LFXS	8-Lead (3mm × 3mm) Plastic DFN	-40°C to 125°C
LT3015IDD#PBF	LT3015IDD#TRPBF	LFXS	8-Lead (3mm × 3mm) Plastic DFN	-40°C to 125°C
LT3015EDD-2.5#PBF	LT3015EDD-2.5#TRPBF	LGDJ	8-Lead (3mm × 3mm) Plastic DFN	-40°C to 125°C
LT3015IDD-2.5#PBF	LT3015IDD-2.5#TRPBF	LGDJ	8-Lead (3mm × 3mm) Plastic DFN	-40°C to 125°C
LT3015EDD-3#PBF	LT3015EDD-3#TRPBF	LGDK	8-Lead (3mm × 3mm) Plastic DFN	-40°C to 125°C
LT3015IDD-3#PBF	LT3015IDD-3#TRPBF	LGDK	8-Lead (3mm × 3mm) Plastic DFN	-40°C to 125°C
LT3015EDD-3.3#PBF	LT3015EDD-3.3#TRPBF	LGDM	8-Lead (3mm × 3mm) Plastic DFN	-40°C to 125°C
LT3015IDD-3.3#PBF	LT3015IDD-3.3#TRPBF	LGDM	8-Lead (3mm × 3mm) Plastic DFN	-40°C to 125°C
LT3015EDD-5#PBF	LT3015EDD-5#TRPBF	LGDN	8-Lead (3mm × 3mm) Plastic DFN	-40°C to 125°C
LT3015IDD-5#PBF	LT3015IDD-5#TRPBF	LGDN	8-Lead (3mm × 3mm) Plastic DFN	-40°C to 125°C
LT3015EDD-12#PBF	LT3015EDD-12#TRPBF	LGDP	8-Lead (3mm × 3mm) Plastic DFN	-40°C to 125°C
LT3015IDD-12#PBF	LT3015IDD-12#TRPBF	LGDP	8-Lead (3mm × 3mm) Plastic DFN	-40°C to 125°C
LT3015EDD-15#PBF	LT3015EDD-15#TRPBF	LGDQ	8-Lead (3mm × 3mm) Plastic DFN	-40°C to 125°C
LT3015IDD-15#PBF	LT3015IDD-15#TRPBF	LGDQ	8-Lead (3mm × 3mm) Plastic DFN	-40°C to 125°C
LT3015EMSE#PBF	LT3015EMSE#TRPBF	3015	12-Lead Plastic MSOP	-40°C to 125°C
LT3015IMSE#PBF	LT3015IMSE#TRPBF	3015	12-Lead Plastic MSOP	-40°C to 125°C
LT3015MPMSE#PBF	LT3015MPMSE#TRPBF	3015	12-Lead Plastic MSOP	-55°C to 125°C
LT3015EMSE-2.5#PBF	LT3015EMSE-2.5#TRPBF	301525	12-Lead Plastic MSOP	-40°C to 125°C
LT3015IMSE-2.5#PBF	LT3015IMSE-2.5#TRPBF	301525	12-Lead Plastic MSOP	-40°C to 125°C
LT3015MPMSE-2.5#PBF	LT3015MPMSE-2.5#TRPBF	301525	12-Lead Plastic MSOP	-55°C to 125°C
LT3015EMSE-3#PBF	LT3015EMSE-3#TRPBF	30153	12-Lead Plastic MSOP	-40°C to 125°C
LT3015IMSE-3#PBF	LT3015IMSE-3#TRPBF	30153	12-Lead Plastic MSOP	-40°C to 125°C
LT3015MPMSE-3#PBF	LT3015MPMSE-3#TRPBF	30153	12-Lead Plastic MSOP	-55°C to 125°C
LT3015EMSE-3.3#PBF	LT3015EMSE-3.3#TRPBF	301533	12-Lead Plastic MSOP	-40°C to 125°C
LT3015IMSE-3.3#PBF	LT3015IMSE-3.3#TRPBF	301533	12-Lead Plastic MSOP	-40°C to 125°C
LT3015MPMSE-3.3#PBF	LT3015MPMSE-3.3#TRPBF	301533	12-Lead Plastic MSOP	-55°C to 125°C
LT3015EMSE-5#PBF	LT3015EMSE-5#TRPBF	30155	12-Lead Plastic MSOP	-40°C to 125°C
LT3015IMSE-5#PBF	LT3015IMSE-5#TRPBF	30155	12-Lead Plastic MSOP	-40°C to 125°C
LT3015MPMSE-5#PBF	LT3015MPMSE-5#TRPBF	30155	12-Lead Plastic MSOP	-55°C to 125°C
LT3015EMSE-12#PBF	LT3015EMSE-12#TRPBF	301512	12-Lead Plastic MSOP	-40°C to 125°C
LT3015IMSE-12#PBF	LT3015IMSE-12#TRPBF	301512	12-Lead Plastic MSOP	-40°C to 125°C
LT3015MPMSE-12#PBF	LT3015MPMSE-12#TRPBF	301512	12-Lead Plastic MSOP	-55°C to 125°C
LT3015EMSE-15#PBF	LT3015EMSE-15#TRPBF	301515	12-Lead Plastic MSOP	-40°C to 125°C
LT3015IMSE-15#PBF	LT3015IMSE-15#TRPBF	301515	12-Lead Plastic MSOP	-40°C to 125°C
LT3015MPMSE-15#PBF	LT3015MPMSE-15#TRPBF	301515	12-Lead Plastic MSOP	-55°C to 125°C

LT3015 Series

ORDER INFORMATION

LEAD FREE FINISH	TAPE AND REEL	PART MARKING*	PACKAGE DESCRIPTION	TEMPERATURE RANGE
LT3015EQ#PBF	LT3015EQ#TRPBF	LT3015Q	5-Lead Plastic DD-Pak	-40°C to 125°C
LT3015IQ#PBF	LT3015IQ#TRPBF	LT3015Q	5-Lead Plastic DD-Pak	-40°C to 125°C
LT3015MPQ#PBF	LT3015MPQ#TRPBF	LT3015Q	5-Lead Plastic DD-Pak	-55°C to 125°C
LT3015EQ-2.5#PBF	LT3015EQ-2.5#TRPBF	LT3015Q-2.5	5-Lead Plastic DD-Pak	-40°C to 125°C
LT3015IQ-2.5#PBF	LT3015IQ-2.5#TRPBF	LT3015Q-2.5	5-Lead Plastic DD-Pak	-40°C to 125°C
LT3015MPQ-2.5#PBF	LT3015MPQ-2.5#TRPBF	LT3015Q-2.5	5-Lead Plastic DD-Pak	-55°C to 125°C
LT3015EQ-3#PBF	LT3015EQ-3#TRPBF	LT3015Q-3	5-Lead Plastic DD-Pak	-40°C to 125°C
LT3015IQ-3#PBF	LT3015IQ-3#TRPBF	LT3015Q-3	5-Lead Plastic DD-Pak	-40°C to 125°C
LT3015MPQ-3#PBF	LT3015MPQ-3#TRPBF	LT3015Q-3	5-Lead Plastic DD-Pak	-55°C to 125°C
LT3015EQ-3.3#PBF	LT3015EQ-3.3#TRPBF	LT3015Q-3.3	5-Lead Plastic DD-Pak	-40°C to 125°C
LT3015IQ-3.3#PBF	LT3015IQ-3.3#TRPBF	LT3015Q-3.3	5-Lead Plastic DD-Pak	-40°C to 125°C
LT3015MPQ-3.3#PBF	LT3015MPQ-3.3#TRPBF	LT3015Q-3.3	5-Lead Plastic DD-Pak	-55°C to 125°C
LT3015EQ-5#PBF	LT3015EQ-5#TRPBF	LT3015Q-5	5-Lead Plastic DD-Pak	-40°C to 125°C
LT3015IQ-5#PBF	LT3015IQ-5#TRPBF	LT3015Q-5	5-Lead Plastic DD-Pak	-40°C to 125°C
LT3015MPQ-5#PBF	LT3015MPQ-5#TRPBF	LT3015Q-5	5-Lead Plastic DD-Pak	-55°C to 125°C
LT3015EQ-12#PBF	LT3015EQ-12#TRPBF	LT3015Q-12	5-Lead Plastic DD-Pak	-40°C to 125°C
LT3015IQ-12#PBF	LT3015IQ-12#TRPBF	LT3015Q-12	5-Lead Plastic DD-Pak	-40°C to 125°C
LT3015MPQ-12#PBF	LT3015MPQ-12#TRPBF	LT3015Q-12	5-Lead Plastic DD-Pak	-55°C to 125°C
LT3015EQ-15#PBF	LT3015EQ-15#TRPBF	LT3015Q-15	5-Lead Plastic DD-Pak	-40°C to 125°C
LT3015IQ-15#PBF	LT3015IQ-15#TRPBF	LT3015Q-15	5-Lead Plastic DD-Pak	-40°C to 125°C
LT3015MPQ-15#PBF	LT3015MPQ-15#TRPBF	LT3015Q-15	5-Lead Plastic DD-Pak	-55°C to 125°C
LT3015ET#PBF	LT3015ET#TRPBF	LT3015T	5-Lead Plastic TO-220	-40°C to 125°C
LT3015IT#PBF	LT3015IT#TRPBF	LT3015T	5-Lead Plastic TO-220	-40°C to 125°C
LT3015ET-2.5#PBF	LT3015ET-2.5#TRPBF	LT3015T-2.5	5-Lead Plastic TO-220	-40°C to 125°C
LT3015IT-2.5#PBF	LT3015IT-2.5#TRPBF	LT3015T-2.5	5-Lead Plastic TO-220	-40°C to 125°C
LT3015ET-3#PBF	LT3015ET-3#TRPBF	LT3015T-3	5-Lead Plastic TO-220	-40°C to 125°C
LT3015IT-3#PBF	LT3015IT-3#TRPBF	LT3015T-3	5-Lead Plastic TO-220	-40°C to 125°C
LT3015ET-3.3#PBF	LT3015ET-3.3#TRPBF	LT3015T-3.3	5-Lead Plastic TO-220	-40°C to 125°C
LT3015IT-3.3#PBF	LT3015IT-3.3#TRPBF	LT3015T-3.3	5-Lead Plastic TO-220	-40°C to 125°C
LT3015ET-5#PBF	LT3015ET-5#TRPBF	LT3015T-5	5-Lead Plastic TO-220	-40°C to 125°C
LT3015IT-5#PBF	LT3015IT-5#TRPBF	LT3015T-5	5-Lead Plastic TO-220	-40°C to 125°C
LT3015ET-12#PBF	LT3015ET-12#TRPBF	LT3015T-12	5-Lead Plastic TO-220	-40°C to 125°C
LT3015IT-12#PBF	LT3015IT-12#TRPBF	LT3015T-12	5-Lead Plastic TO-220	-40°C to 125°C
LT3015ET-15#PBF	LT3015ET-15#TRPBF	LT3015T-15	5-Lead Plastic TO-220	-40°C to 125°C
LT3015IT-15#PBF	LT3015IT-15#TRPBF	LT3015T-15	5-Lead Plastic TO-220	-40°C to 125°C

Consult LTC Marketing for parts specified with wider operating temperature ranges. *The temperature grade is identified by a label on the shipping container. Consult LTC Marketing for information on non-standard lead based finish parts.

For more information on lead free part marking, go to: <http://www.linear.com/leadfree/>

For more information on tape and reel specifications, go to: <http://www.linear.com/tapeandree/>

ELECTRICAL CHARACTERISTICS

The ● denotes the specifications which apply over the full operating temperature range, otherwise specifications are at $T_A = 25^\circ\text{C}$.

PARAMETER	CONDITIONS	MIN	TYP	MAX	UNITS	
Minimum IN Pin Voltage (Notes 2, 12)	$I_{LOAD} = -0.5\text{A}$	●	-1.8		V	
	$I_{LOAD} = -1.5\text{A}$		-1.8	-2.3	V	
Regulated Output Voltage (Note 3)	LT3015-2.5: $V_{IN} = -3.0\text{V}$, $I_{LOAD} = -1\text{mA}$	●	-2.475	-2.5	-2.525	V
	LT3015-2.5: $-30\text{V} < V_{IN} < -3.5\text{V}$, $-1.5\text{A} < I_{LOAD} < -1\text{mA}$	●	-2.45	-2.5	-2.55	V
	LT3015-3: $V_{IN} = -3.5$, $I_{LOAD} = -1\text{mA}$	●	-2.97	-3	-3.03	V
	LT3015-3: $-30\text{V} < V_{IN} < -4\text{V}$, $-1.5\text{A} < I_{LOAD} < -1\text{mA}$	●	-2.94	-3	-3.06	V
	LT3015-3.3: $V_{IN} = -3.8$, $I_{LOAD} = -1\text{mA}$	●	-3.267	-3.3	-3.333	V
	LT3015-3.3: $-30\text{V} < V_{IN} < -4.3\text{V}$, $-1.5\text{A} < I_{LOAD} < -1\text{mA}$	●	-3.234	-3.3	-3.366	V
	LT3015-5: $V_{IN} = -5.5$, $I_{LOAD} = -1\text{mA}$	●	-4.95	-5	-5.05	V
	LT3015-5: $-30\text{V} < V_{IN} < -6\text{V}$, $-1.5\text{A} < I_{LOAD} < -1\text{mA}$	●	-4.9	-5	-5.1	V
	LT3015-12: $V_{IN} = -12.5$, $I_{LOAD} = -1\text{mA}$	●	-11.88	-12	-12.12	V
	LT3015-12: $-30\text{V} < V_{IN} < -13\text{V}$, $-1.5\text{A} < I_{LOAD} < -1\text{mA}$	●	-11.76	-12	-12.24	V
	LT3015-15: $V_{IN} = -15.5$, $I_{LOAD} = -1\text{mA}$	●	-14.85	-15	-15.15	V
LT3015-15: $-30\text{V} < V_{IN} < -16\text{V}$, $-1.5\text{A} < I_{LOAD} < -1\text{mA}$	●	-14.7	-15	-15.3	V	
ADJ Pin Voltage (Notes 2, 3)	LT3015: $V_{IN} = -2.3\text{V}$, $I_{LOAD} = -1\text{mA}$	●	-1.208	-1.22	-1.232	V
	LT3015: $-30\text{V} < V_{IN} < -2.3\text{V}$, $-1.5\text{A} < I_{LOAD} < -1\text{mA}$	●	-1.196	-1.22	-1.244	V
Line Regulation	LT3015-2.5: $\Delta V_{IN} = -3.0\text{V}$ to -30V , $I_{LOAD} = -1\text{mA}$	●		4	12	mV
	LT3015-3: $\Delta V_{IN} = -3.5\text{V}$ to -30V , $I_{LOAD} = -1\text{mA}$	●		4.5	15	mV
	LT3015-3.3: $\Delta V_{IN} = -3.8\text{V}$ to -30V , $I_{LOAD} = -1\text{mA}$	●		5	16	mV
	LT3015-5: $\Delta V_{IN} = -5.5\text{V}$ to -30V , $I_{LOAD} = -1\text{mA}$	●		5.5	20	mV
	LT3015-12: $\Delta V_{IN} = -12.5\text{V}$ to -30V , $I_{LOAD} = -1\text{mA}$	●		9	27	mV
	LT3015-15: $\Delta V_{IN} = -15.5\text{V}$ to -30V , $I_{LOAD} = -1\text{mA}$	●		9	27	mV
	LT3015: $\Delta V_{IN} = -2.3\text{V}$ to -30V , $I_{LOAD} = -1\text{mA}$ (Note 2)	●		2.5	6	mV
Load Regulation	LT3015-2.5: $V_{IN} = -3.5\text{V}$, $\Delta I_{LOAD} = -1\text{mA}$ to -1.5A	●		3	6	mV
	LT3015-2.5: $V_{IN} = -3.5\text{V}$, $\Delta I_{LOAD} = -1\text{mA}$ to -1.5A	●			18	mV
	LT3015-3: $V_{IN} = -4\text{V}$, $\Delta I_{LOAD} = -1\text{mA}$ to -1.5A	●		4	7.5	mV
	LT3015-3: $V_{IN} = -4\text{V}$, $\Delta I_{LOAD} = -1\text{mA}$ to -1.5A	●			23	mV
	LT3015-3.3: $V_{IN} = -4.3\text{V}$, $\Delta I_{LOAD} = -1\text{mA}$ to -1.5A	●		5	10.5	mV
	LT3015-3.3: $V_{IN} = -4.3\text{V}$, $\Delta I_{LOAD} = -1\text{mA}$ to -1.5A	●			25	mV
	LT3015-5: $V_{IN} = -6\text{V}$, $\Delta I_{LOAD} = -1\text{mA}$ to -1.5A	●		5.5	10.5	mV
	LT3015-5: $V_{IN} = -6\text{V}$, $\Delta I_{LOAD} = -1\text{mA}$ to -1.5A	●			26	mV
	LT3015-12: $V_{IN} = -13\text{V}$, $\Delta I_{LOAD} = -1\text{mA}$ to -1.5A	●		13	25	mV
	LT3015-12: $V_{IN} = -13\text{V}$, $\Delta I_{LOAD} = -1\text{mA}$ to -1.5A	●			62	mV
	LT3015-15: $V_{IN} = -16\text{V}$, $\Delta I_{LOAD} = -1\text{mA}$ to -1.5A	●		16	30	mV
	LT3015-15: $V_{IN} = -16\text{V}$, $\Delta I_{LOAD} = -1\text{mA}$ to -1.5A	●			73	mV
	LT3015: $V_{IN} = -2.3\text{V}$, $\Delta I_{LOAD} = -1\text{mA}$ to -1.5A (Note 2)	●		2	3.8	mV
LT3015: $V_{IN} = -2.3\text{V}$, $\Delta I_{LOAD} = -1\text{mA}$ to -1.5A (Note 2)	●			9	mV	
Dropout Voltage $V_{IN} = V_{OUT(\text{NOMINAL})}$ (Notes 4, 5)	$I_{LOAD} = -1\text{mA}$	●		0.055	0.095	V
	$I_{LOAD} = -1\text{mA}$	●			0.16	V
	$I_{LOAD} = -100\text{mA}$	●		0.1	0.16	V
	$I_{LOAD} = -100\text{mA}$	●			0.24	V
	$I_{LOAD} = -500\text{mA}$ (DFN/MSOP)	●		0.17	0.23	V
	$I_{LOAD} = -500\text{mA}$ (DFN/MSOP)	●			0.32	V
	$I_{LOAD} = -500\text{mA}$ (DD-PAK/TO-220)	●		0.2	0.27	V
	$I_{LOAD} = -500\text{mA}$ (DD-PAK/TO-220)	●			0.39	V
	$I_{LOAD} = -1.5\text{A}$ (DFN/MSOP)	●		0.31	0.39	V
	$I_{LOAD} = -1.5\text{A}$ (DFN/MSOP)	●			0.5	V
	$I_{LOAD} = -1.5\text{A}$ (DD-PAK/TO-220)	●		0.41	0.51	V
$I_{LOAD} = -1.5\text{A}$ (DD-PAK/TO-220)	●			0.68	V	
GND Pin Current $V_{IN} = V_{OUT(\text{NOMINAL})}$ (Notes 4, 6)	$I_{LOAD} = 0\text{mA}$	●		1.1	2.4	mA
	$I_{LOAD} = -1\text{mA}$	●		1.15	2.5	mA
	$I_{LOAD} = -100\text{mA}$	●		2.9	7	mA
	$I_{LOAD} = -500\text{mA}$	●		9.5	23	mA
	$I_{LOAD} = -1.5\text{A}$	●		35	70	mA
Output Voltage Noise (Note 2)	LT3015: $C_{OUT} = 10\mu\text{F}$, $I_{LOAD} = -1.5\text{A}$, $\text{BW} = 10\text{Hz}$ to 100kHz , $V_{OUT} = -1.22\text{V}$			60	μV_{RMS}	
SENSE Pin Bias Current (Note 13)	LT3015-2.5/-3/-3.3/-5/-12/-15	●	70	100	130	μA

LT3015 Series

ELECTRICAL CHARACTERISTICS

The ● denotes the specifications which apply over the full operating temperature range, otherwise specifications are at $T_A = 25^\circ\text{C}$.

PARAMETER	CONDITIONS	MIN	TYP	MAX	UNITS
ADJ Pin Bias Current (Notes 2, 7)	LT3015: $V_{IN} = -2.3\text{V}$	-200	30	200	nA
Shutdown Threshold (Note 11)	$V_{OUT} = \text{Off-to-On (Positive)}$	● 1.07	1.21	1.35	V
	$V_{OUT} = \text{Off-to-On (Negative)}$	● -1.34	-1.2	-1.06	V
	$V_{OUT} = \text{On-to-Off (Positive)}$	● 0.5	0.73		V
	$V_{OUT} = \text{On-to-Off (Negative)}$	●	-0.73	-0.5	V
SHDN Pin Current (Note 8)	$V_{SHDN} = 0\text{V}$	● -1	0	1	μA
	$V_{SHDN} = 15\text{V}$	●	17	27	μA
	$V_{SHDN} = -15\text{V}$	●	-2.8	-4.5	μA
Quiescent Current in Shutdown	$V_{IN} = -6\text{V}, V_{SHDN} = 0\text{V}$	●	0.01	6	μA
Ripple Rejection $V_{RIPPLE} = 0.5\text{V}_{P-P}$, $f_{RIPPLE} = 120\text{Hz}$, $I_{LOAD} = -1.5\text{A}$	LT3015-2.5: $V_{IN} = -4\text{V (Avg)}$		52	62	dB
	LT3015-3: $V_{IN} = -4.5\text{V (Avg)}$		52	62	dB
	LT3015-3.3: $V_{IN} = -4.8\text{V (Avg)}$		51	61	dB
	LT3015-5: $V_{IN} = -6.5\text{V (Avg)}$		48	58	dB
	LT3015-12: $V_{IN} = -13.5\text{V (Avg)}$		43	53	dB
	LT3015-15: $V_{IN} = -16.5\text{V (Avg)}$		40	50	dB
	LT3015: $V_{IN} = -2.5\text{V (Avg)}$ (Note 2)		55	65	dB
Current Limit (Note 14)	$V_{IN} = -2.3\text{V}, V_{OUT} = 0\text{V}$	● 1.7	2	2.3	A
	LT3015-2.5/-3/-3.3/-5/-12/-15: $V_{IN} = V_{OUT(NOMINAL)} - 1\text{V}, \Delta V_{OUT} = -5\%$	● 1.7	2	2.3	A
	LT3015: $V_{IN} = -2.3\text{V}, \Delta V_{OUT} = 0.1\text{V}$	● 1.7	2	2.3	A
Input Reverse Leakage Current	LT3015-2.5/-3/-3.3/-5/-12/-15: $V_{IN} = 30\text{V}, V_{OUT}, V_{ADJ}, V_{SHDN} = \text{Open Circuit}$	●	4	5.5	mA
	LT3015: $V_{IN} = 30\text{V}, V_{OUT}, V_{ADJ}, V_{SHDN} = \text{Open Circuit}$	●	1.55	1.7	mA

Note 1: Stresses beyond those listed under Absolute Maximum Ratings may cause permanent damage to the device. Exposure to any Absolute Maximum Rating condition for extended periods may affect device reliability and lifetime.

Note 2: The LT3015 adjustable version is tested and specified for these conditions with the ADJ pin connected to the OUT pin.

Note 3: Maximum junction temperature limits operating conditions. The regulated output voltage specification does not apply for all possible combinations of input voltage and output current, especially due to the current limit foldback which starts to decrease current limit at about $|V_{IN} - V_{OUT}| = 8\text{V}$. If operating at maximum output current, limit the input voltage range. If operating at maximum input voltage, limit the output current range.

Note 4: To satisfy minimum input voltage requirements, the LT3015 is tested and specified for these conditions with an external resistor divider (54.9k top, 49.9k bottom) for an output voltage of -2.56V . The external resistor adds $25\mu\text{A}$ of DC load on the output.

Note 5: Dropout voltage is the minimum input-to-output voltage differential needed to maintain regulation at a specified output current. In dropout, the output voltage is: $V_{IN} + V_{DROPOUT}$.

Note 6: GND pin current is tested with $V_{IN} = V_{OUT(NOMINAL)}$ and a current source load. Therefore, the device is tested while operating in dropout. This is the worst-case GND pin current. GND pin current decreases slightly at higher input voltages.

Note 7: Positive ADJ pin bias current flows into the ADJ pin.

Note 8: Positive SHDN pin current flows into the SHDN pin.

Note 9: The LT3015 is tested and specified under pulsed load conditions such that $T_J \equiv T_A$. The LT3015E is guaranteed to meet performance specifications from 0°C to 125°C junction temperature. Specifications over the -40°C to 125°C operating temperature range are assured by design, characterization, and correlation with statistical process controls. The LT3015I is guaranteed over the full -40°C to 125°C operating junction temperature range. The LT3015MP is 100% tested and guaranteed over the full -55°C to 125°C operating junction temperature range.

Note 10: Parasitic diodes exist internally between the OUT, ADJ, SHDN pins and the IN pin. Do not drive the OUT, ADJ, and SHDN pins more than 0.3V below the IN pin during fault conditions, and these pins must remain at a voltage more positive than IN during normal operation.

Note 11: The SHDN threshold must be met to ensure device operation.

Note 12: For LT3015, the minimum input voltage refers to the lowest input voltage before the parts goes out of regulation. For the fixed voltage versions of LT3015, the minimum input voltage refers to the lowest input voltage before the part can no longer sink 1.5A ; for proper regulation, the dropout voltage requirements must be met.

Note 13: Sense pin current flows out of the pin.

Note 14: The current limit circuit incorporates foldback that decreases current limit for $|V_{IN} - V_{OUT}| \geq 8\text{V}$. Some level of output current is provided at all $V_{IN} - V_{OUT}$ differential voltages. Please consult the Typical Performance Characteristics graph for Current Limit vs $V_{IN} - V_{OUT}$.

TYPICAL PERFORMANCE CHARACTERISTICS $T_A = 25^\circ\text{C}$, unless otherwise noted.

Typical Dropout Voltage (DFN/MSOP)

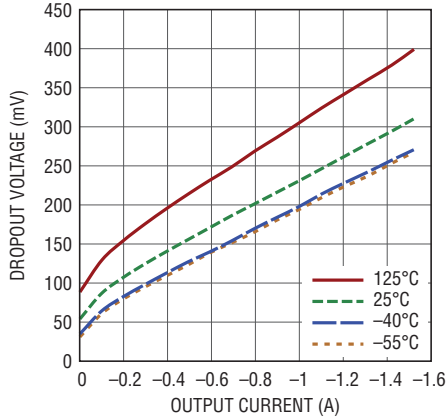

3015 G01

Guaranteed Dropout Voltage (DFN/MSOP)

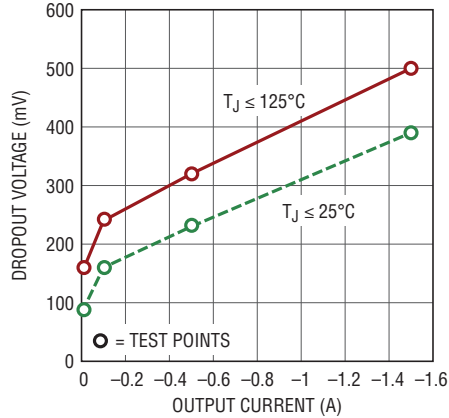

3015 G02

Dropout Voltage (DFN/MSOP)

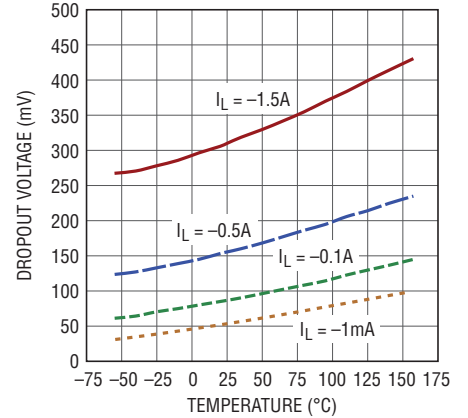

3015 G03

Typical Dropout Voltage (DD-PAK/TO-220)

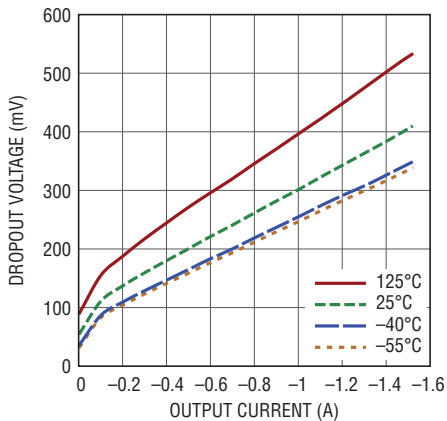

3015 G04

Guaranteed Dropout Voltage (DD-PAK/TO-220)

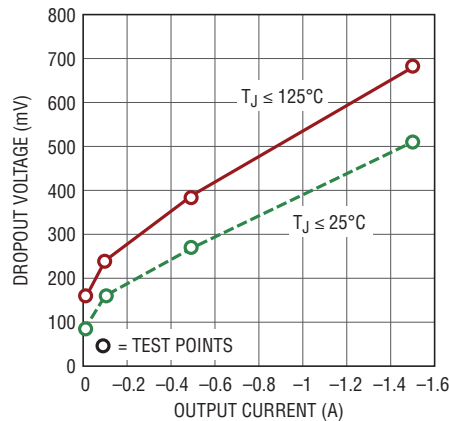

3015 G05

Dropout Voltage (DD-PAK/TO-220)

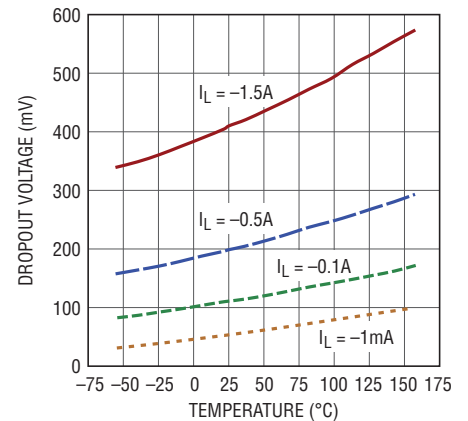

3015 G06

Quiescent Current

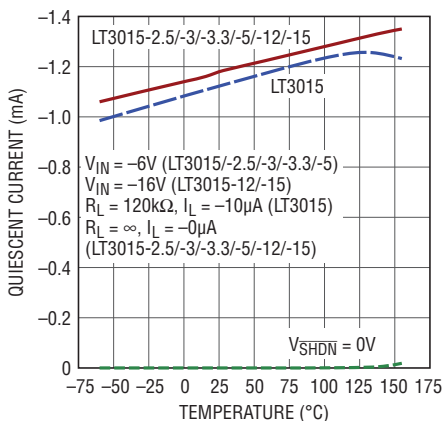

3015 G07

LT3015 ADJ Pin Voltage

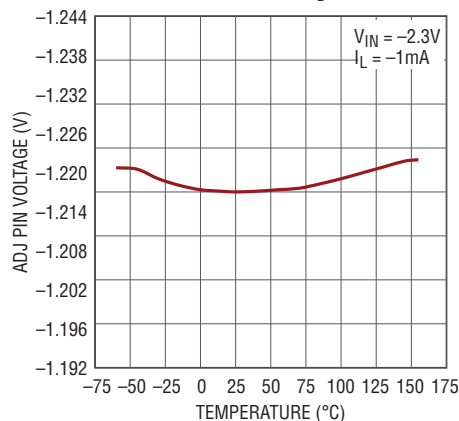

3015 G08

LT3015-2.5 Output Voltage

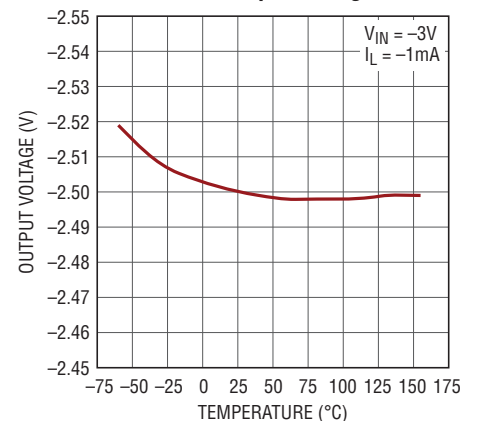

3015 G09

TYPICAL PERFORMANCE CHARACTERISTICS $T_A = 25^\circ\text{C}$, unless otherwise noted.

LT3015-3 Output Voltage

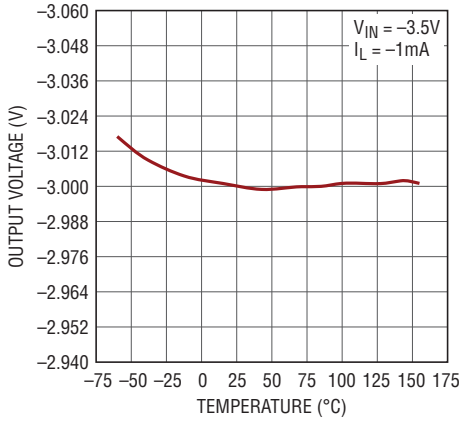

3015 G10

LT3015-3.3 Output Voltage

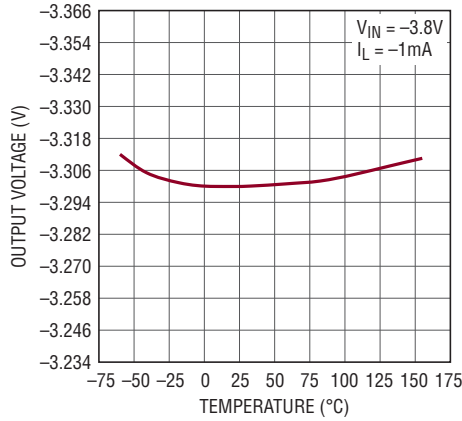

3015 G11

LT3015-5 Output Voltage

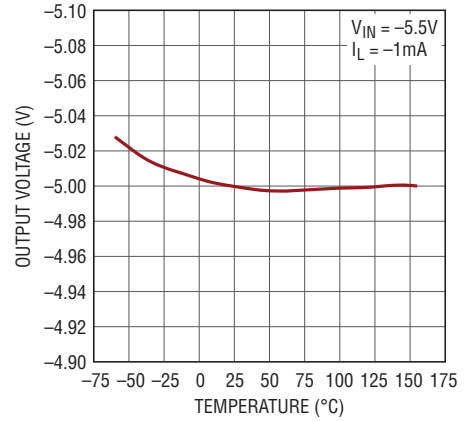

3015 G12

LT3015-12 Output Voltage

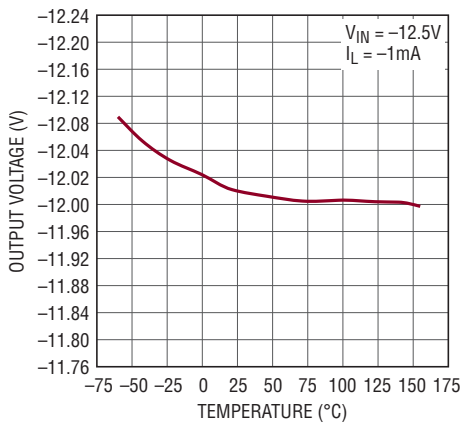

3015 G13

LT3015-15 Output Voltage

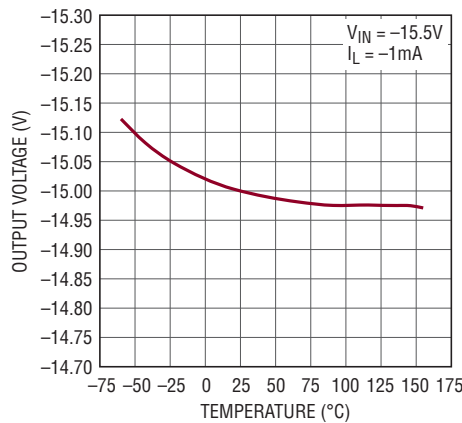

3015 G14

LT3015 Quiescent Current

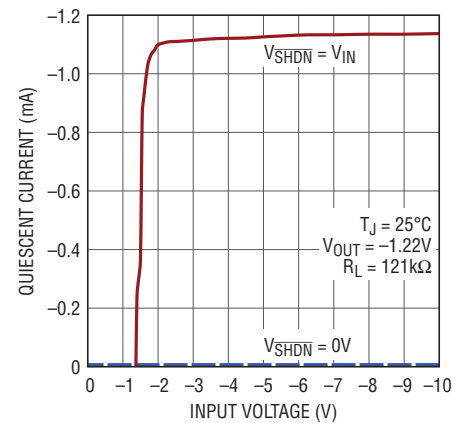

3015 G15

LT3015-2.5 Quiescent Current

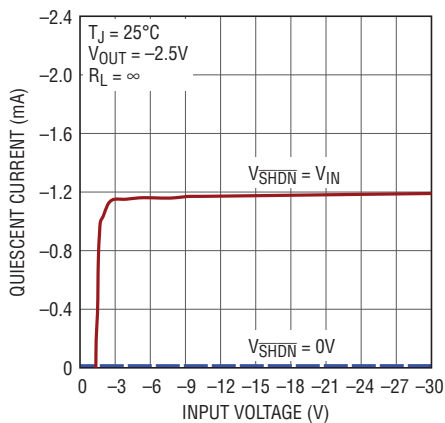

3015 G16

LT3015-3 Quiescent Current

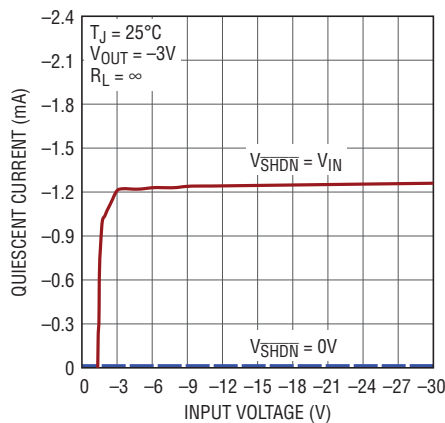

3015 G17

LT3015-3.3 Quiescent Current

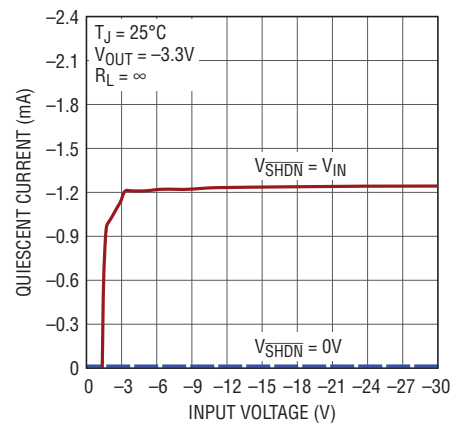

3015 G18

3015fb

TYPICAL PERFORMANCE CHARACTERISTICS $T_A = 25^\circ\text{C}$, unless otherwise noted.

LT3015-5 Quiescent Current

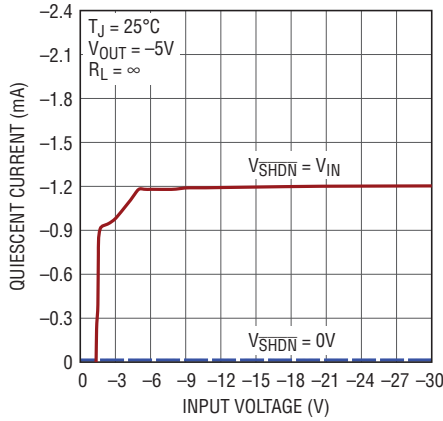

LT3015-12 Quiescent Current

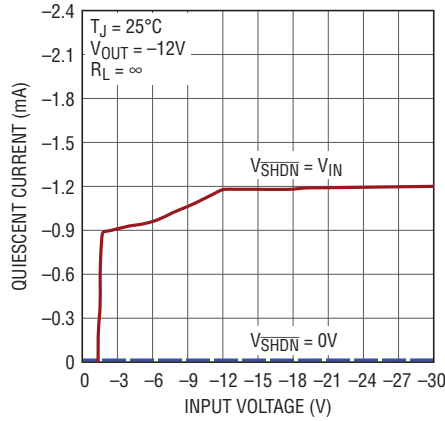

LT3015-15 Quiescent Current

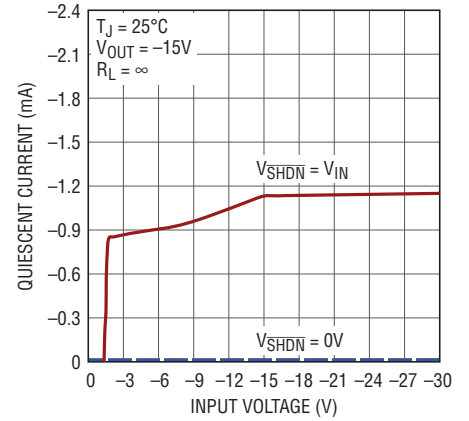

LT3015 GND Pin Current

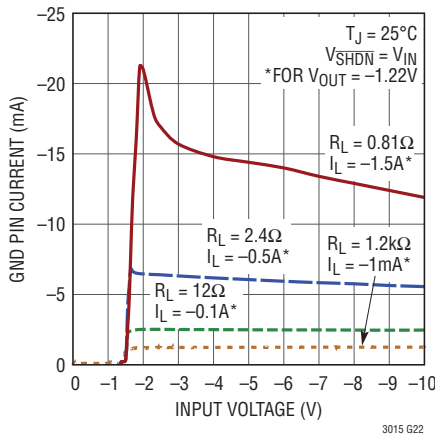

LT3015-2.5 GND Pin Current

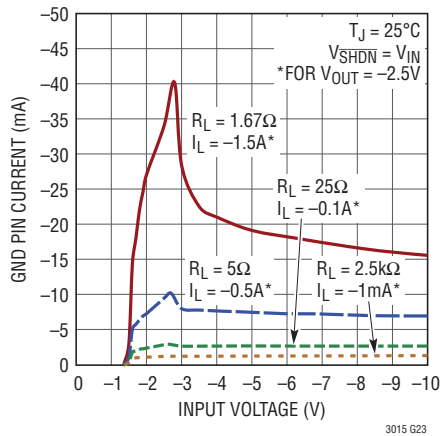

LT3015-3 GND Pin Current

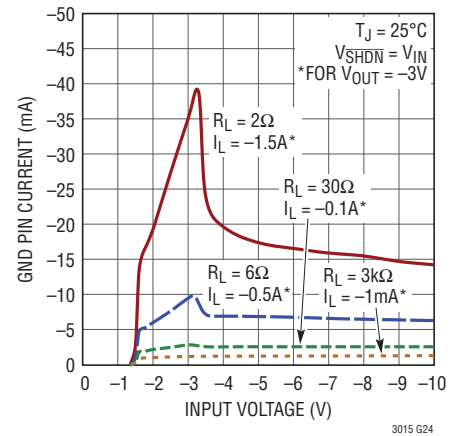

LT3015-3.3 GND Pin Current

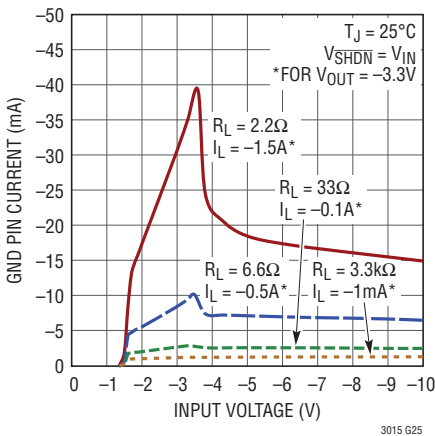

LT3015-5 GND Pin Current

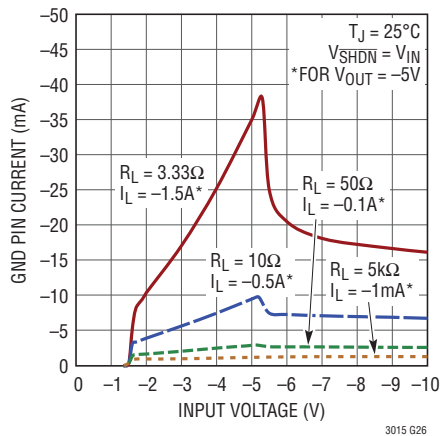

LT3015-12 GND Pin Current

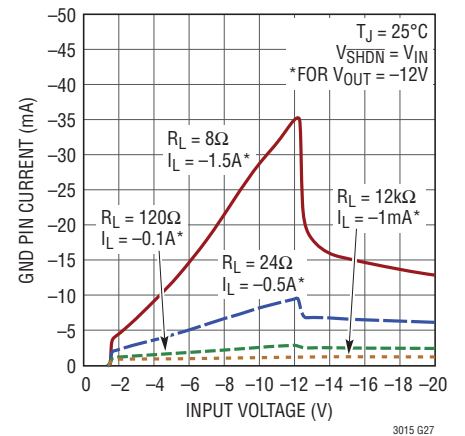

TYPICAL PERFORMANCE CHARACTERISTICS $T_A = 25^\circ\text{C}$, unless otherwise noted.

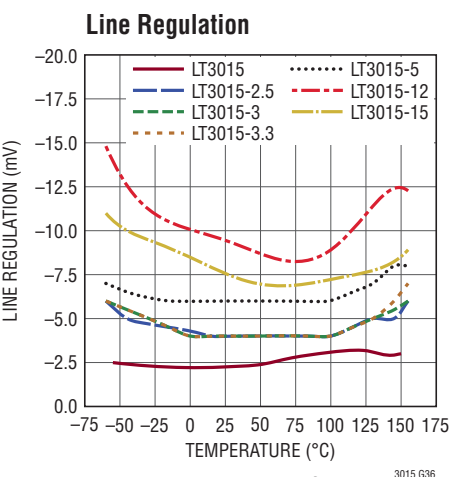
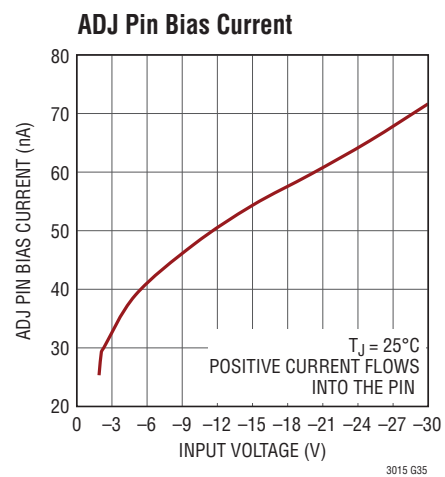
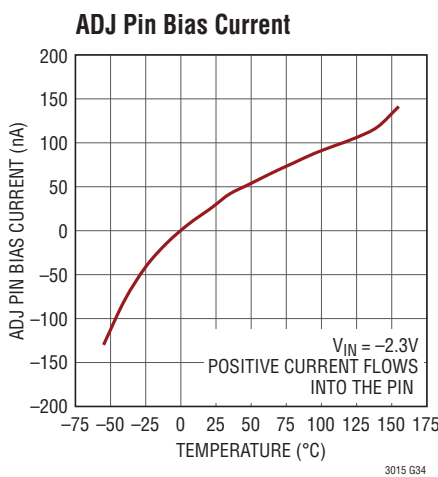
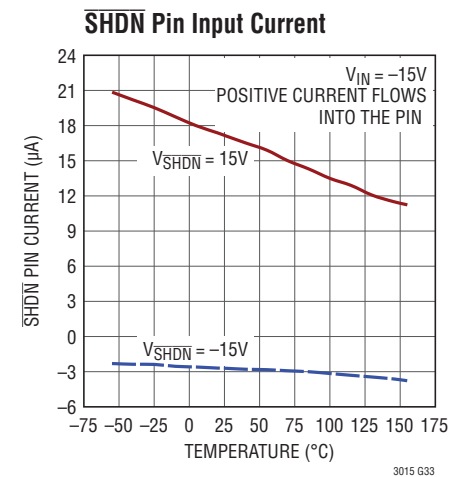
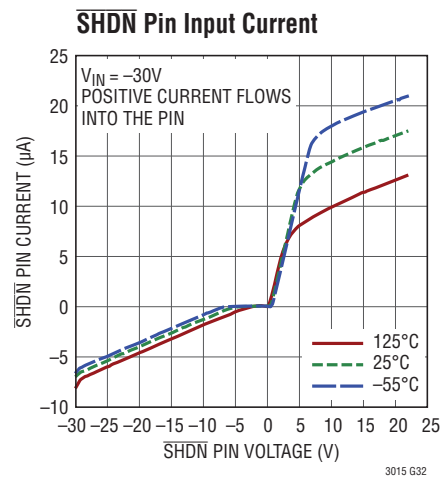
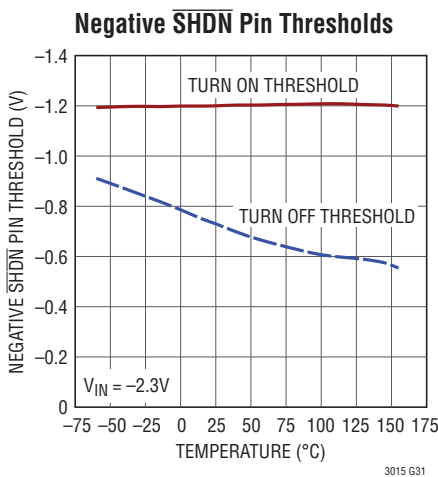
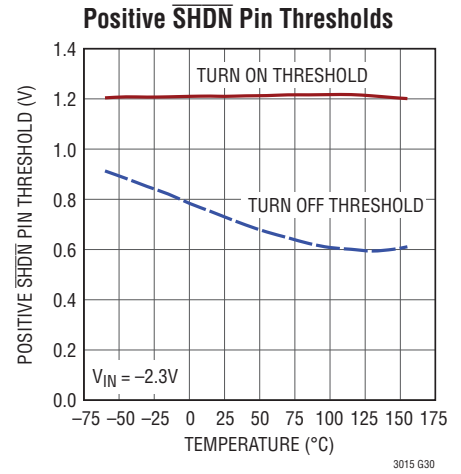
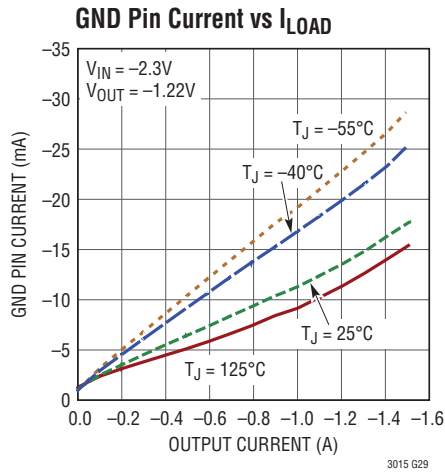
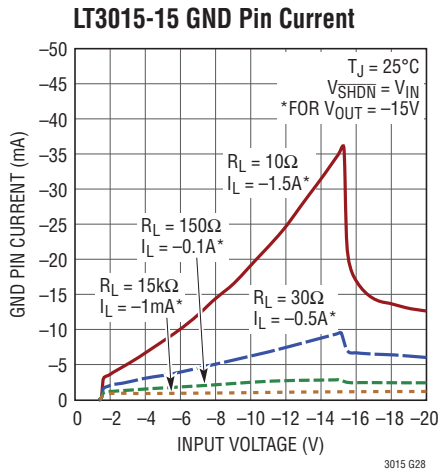

$\Delta V_{IN} = V_{OUT(NOMINAL)} - 0.5\text{V TO } -30\text{V}$
 (LT3015-2.5/-3/-3.3/-5/-12/-15)
 $\Delta V_{IN} = -2.3\text{V TO } -30\text{V}$ (LT3015)
 $I_L = -1\text{mA}$

TYPICAL PERFORMANCE CHARACTERISTICS $T_A = 25^\circ\text{C}$, unless otherwise noted.

Load Regulation

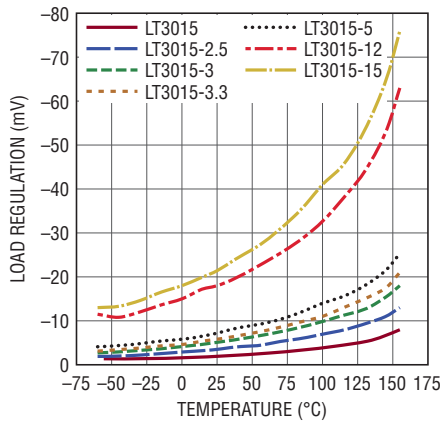

$V_{IN} = V_{OUT(NOMINAL)} - 1\text{V}$
 (LT3015-2.5/-3/-3.3/-5/-12/-15)
 $V_{IN} = -2.3\text{V}$ (LT3015)
 $\Delta I_L = -1\text{mA TO } -1.5\text{A}$

Current Limit vs $V_{IN} - V_{OUT}$

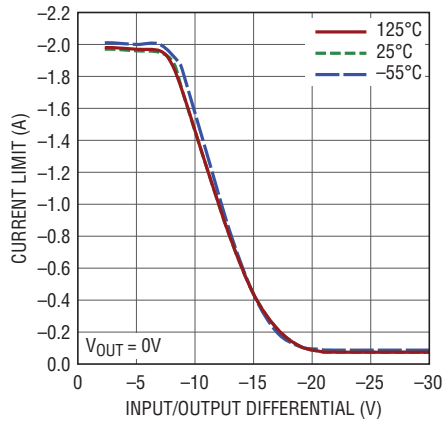

$V_{OUT} = 0\text{V}$

Current Limit vs Temperature

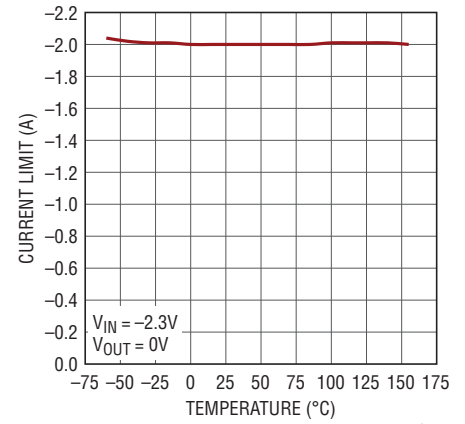

$V_{IN} = -2.3\text{V}$
 $V_{OUT} = 0\text{V}$

LT3015 Input Ripple Rejection

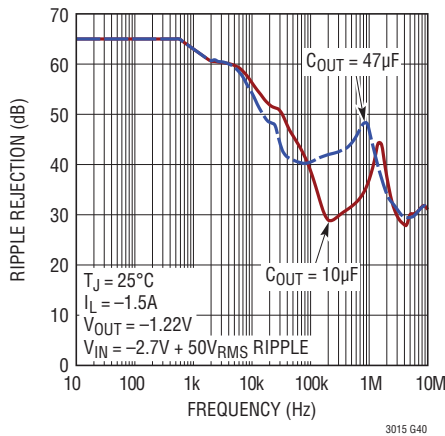

$T_J = 25^\circ\text{C}$
 $I_L = -1.5\text{A}$
 $V_{OUT} = -1.22\text{V}$
 $V_{IN} = -2.7\text{V} + 50\text{V}_{\text{RMS}} \text{ RIPPLE}$

LT3015 Input Ripple Rejection

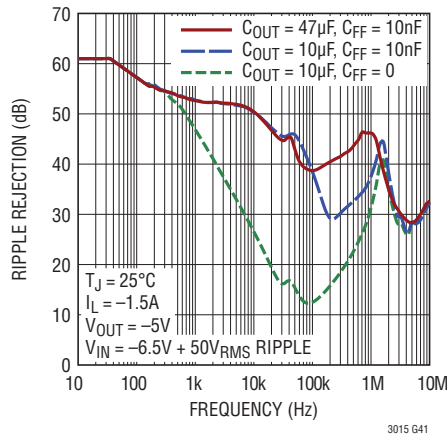

$T_J = 25^\circ\text{C}$
 $I_L = -1.5\text{A}$
 $V_{OUT} = -5\text{V}$
 $V_{IN} = -6.5\text{V} + 50\text{V}_{\text{RMS}} \text{ RIPPLE}$

Ripple Rejection vs Temperature

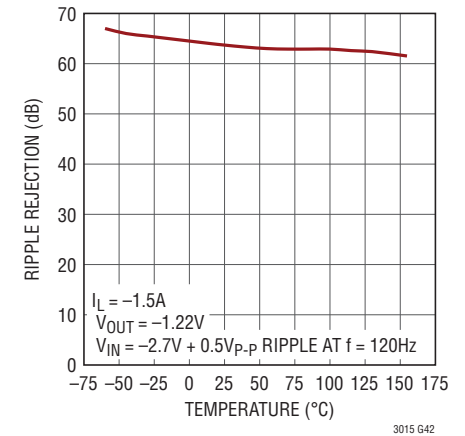

$I_L = -1.5\text{A}$
 $V_{OUT} = -1.22\text{V}$
 $V_{IN} = -2.7\text{V} + 0.5\text{V}_{\text{p-p}} \text{ RIPPLE AT } f = 120\text{Hz}$

Minimum Input Voltage

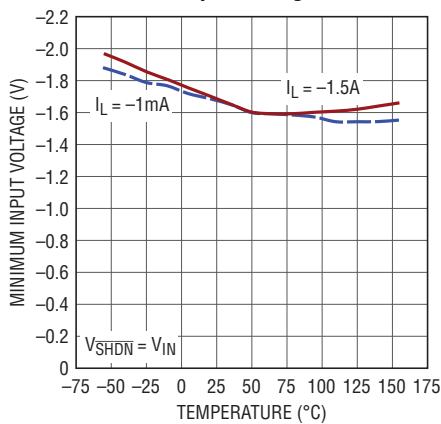

$V_{SHDN} = V_{IN}$

Output Noise Spectral Density

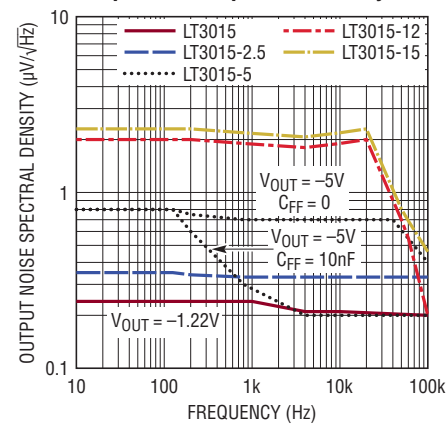

$C_{OUT} = 10\mu\text{F}$
 $I_L = -1.5\text{A}$
 $I_{\text{FB-DIVIDER}} = 100\mu\text{A}$

RMS Output Noise vs Load Current

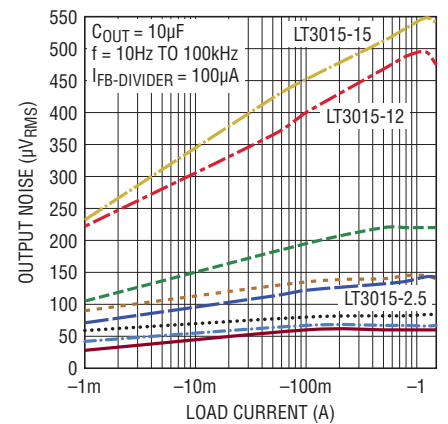

$C_{OUT} = 10\mu\text{F}$
 $f = 10\text{Hz TO } 100\text{kHz}$
 $I_{\text{FB-DIVIDER}} = 100\mu\text{A}$

- NOISE AT $V_{OUT} = -1.22\text{V}$
- NOISE AT $V_{OUT} = -5\text{V}, C_{FF} = 0$
- NOISE AT $V_{OUT} = -5\text{V}, C_{FF} = 100\text{pF}$
- NOISE AT $V_{OUT} = -5\text{V}, C_{FF} = 1\text{nF}$
- NOISE AT $V_{OUT} = -5\text{V}, C_{FF} = 10\text{nF}$

3015fb

TYPICAL PERFORMANCE CHARACTERISTICS $T_A = 25^\circ\text{C}$, unless otherwise noted.

RMS Output Noise vs Feedforward Capacitor (C_{FF})

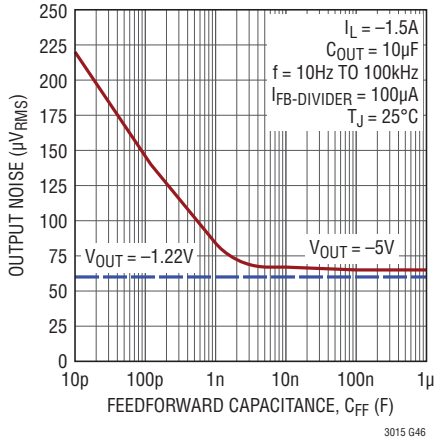

LT3015 10Hz to 100kHz Output Noise

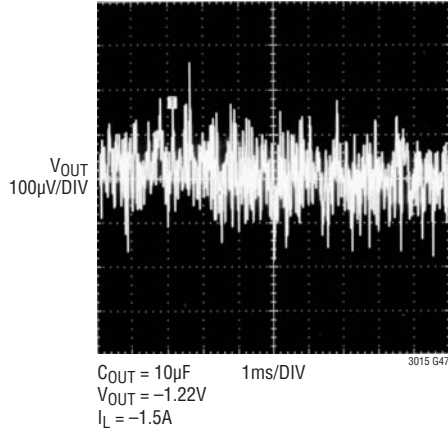

LT3015 10Hz to 100kHz Output Noise, $C_{FF} = 0$

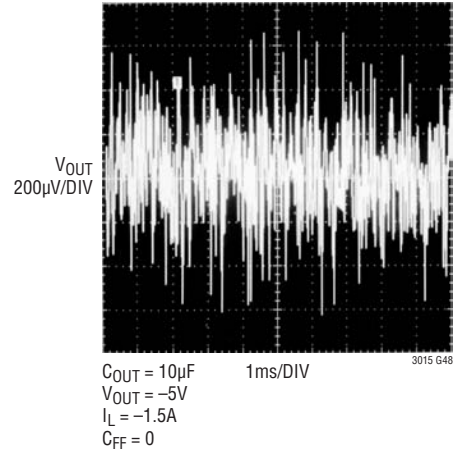

LT3015 10Hz to 100kHz Output Noise, $C_{FF} = 10\text{nF}$

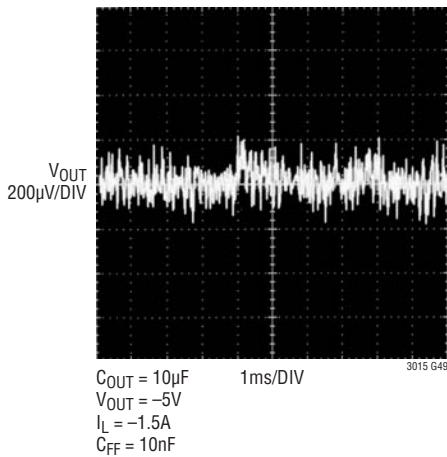

SHDN Transient Response, $I_L = -5\text{mA}$, $C_{FF} = 0$

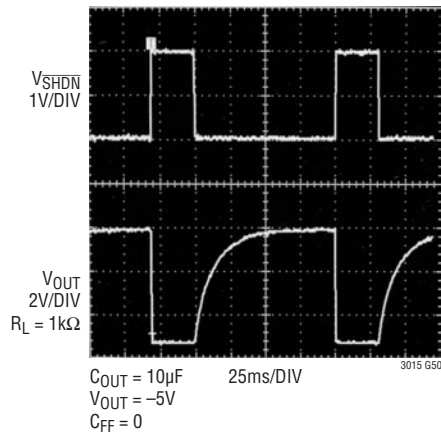

SHDN Transient Response, $I_L = -1.5\text{A}$, $C_{FF} = 0$

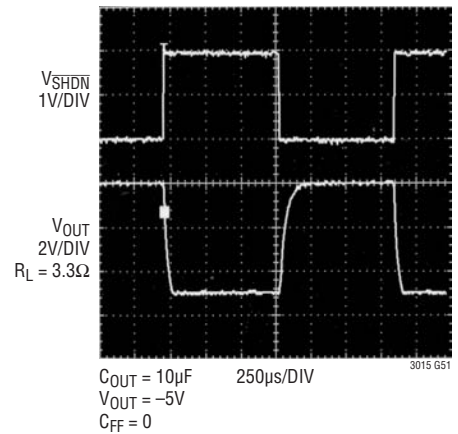

SHDN Transient Response, $I_L = -1.5\text{A}$, $C_{FF} = 10\text{nF}$

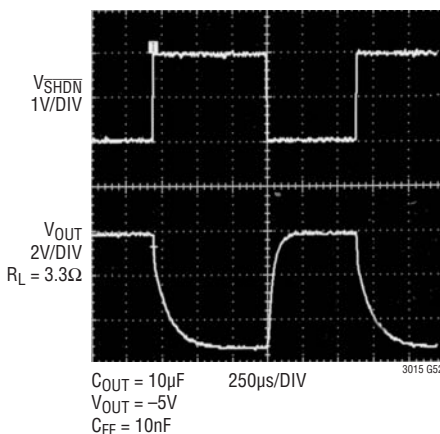

Start-Up Time vs C_{FF}

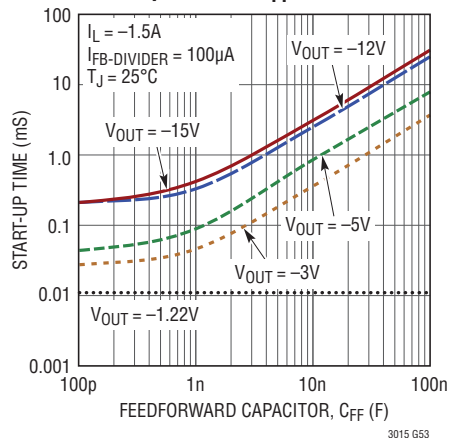

LT3015 Transient Response, $C_{OUT} = 10\mu\text{F}$

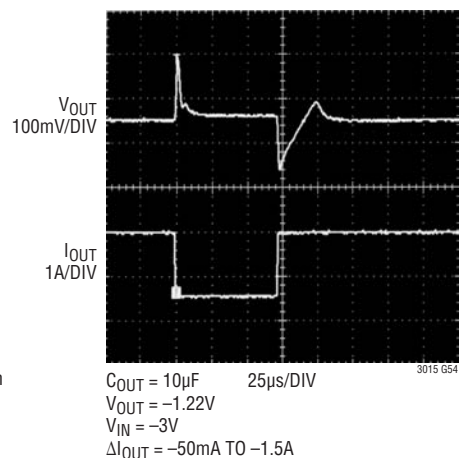

3015fb

TYPICAL PERFORMANCE CHARACTERISTICS $T_A = 25^\circ\text{C}$, unless otherwise noted.

**LT3015 Transient Response,
 $C_{OUT} = 47\mu\text{F}$**

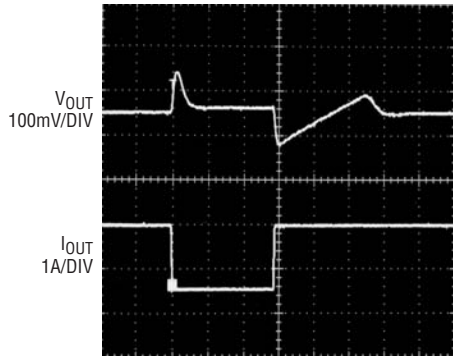

$C_{OUT} = 47\mu\text{F}$ 25 $\mu\text{s}/\text{DIV}$
 $V_{OUT} = -1.22\text{V}$
 $V_{IN} = -3\text{V}$
 $\Delta I_{OUT} = -50\text{mA TO } -1.5\text{A}$

**LT3015 Transient Response,
 $C_{FF} = 0, C_{OUT} = 10\mu\text{F}$**

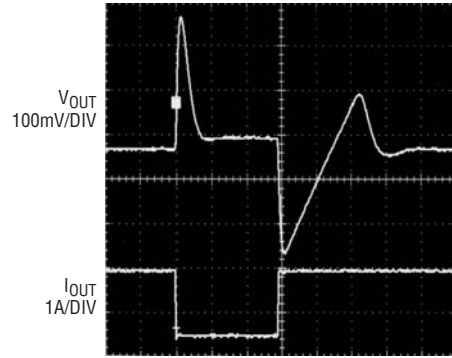

$C_{OUT} = 10\mu\text{F}$ 25 $\mu\text{s}/\text{DIV}$
 $V_{OUT} = -5\text{V}$
 $V_{IN} = -6.5\text{V}$
 $C_{FF} = 0$
 $I_{FB-DIVIDER} = 100\mu\text{A}$
 $\Delta I_{OUT} = -50\text{mA TO } -1.5\text{A}$

**LT3015 Transient Response,
 $C_{FF} = 10\text{nF}, C_{OUT} = 10\mu\text{F}$**

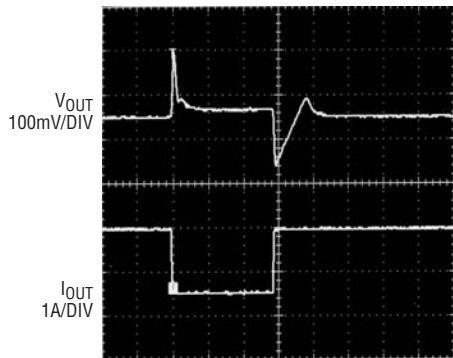

$C_{OUT} = 10\mu\text{F}$ 25 $\mu\text{s}/\text{DIV}$
 $V_{OUT} = -5\text{V}$
 $V_{IN} = -6.5\text{V}$
 $C_{FF} = 10\text{nF}$
 $I_{FB-DIVIDER} = 100\mu\text{A}$
 $\Delta I_{OUT} = -50\text{mA TO } -1.5\text{A}$

**LT3015 Transient Response,
 $C_{FF} = 10\text{nF}, C_{OUT} = 47\mu\text{F}$**

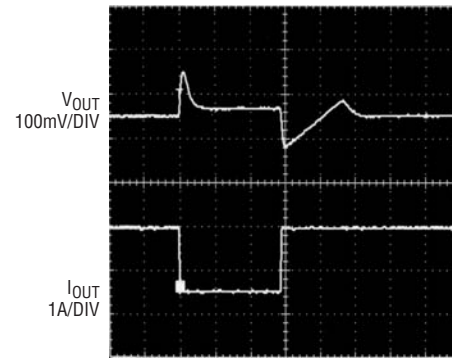

$C_{OUT} = 47\mu\text{F}$ 25 $\mu\text{s}/\text{DIV}$
 $V_{OUT} = -5\text{V}$
 $V_{IN} = -6.5\text{V}$
 $C_{FF} = 10\text{nF}$
 $I_{FB-DIVIDER} = 100\mu\text{A}$
 $\Delta I_{OUT} = -50\text{mA TO } -1.5\text{A}$

PIN FUNCTIONS (DFN/MSOP/Q/T)

IN (Pins 1, 2, Exposed Pad Pin 9 / 1, 2, 3, 4, Exposed Pad Pin 13 / 3, Tab / 3, Tab): Input. These pins supply power to the regulator. The Tab of the DD-Pak, TO-220 and the exposed backside pad of the DFN and MSOP packages is an electrical connection to IN and to the device's substrate. For proper electrical and thermal performance, tie all IN pins together and tie IN to the exposed backside or Tab of the relevant package on the PCB. See the Applications Information Section for thermal considerations and calculating junction temperature. The LT3015 requires a bypass capacitor at IN. In general, a battery's output impedance rises with frequency, so include a bypass capacitor in battery powered applications. An input bypass capacitor in the range of $1\mu\text{F}$ to $10\mu\text{F}$ generally suffices, but applications with large load transients may require higher input capacitance to prevent input supply droop and prevent the regulator from entering dropout.

SHDN (Pin 3 / 5 / 1 / 1): Shutdown. Use the $\overline{\text{SHDN}}$ pin to put the LT3015 into a micropower shutdown state. The $\overline{\text{SHDN}}$ function is bi-directional, allowing use of either positive or negative logic. The $\overline{\text{SHDN}}$ pin threshold voltages are referenced to GND. The output of the LT3015 is OFF if the $\overline{\text{SHDN}}$ pin is pulled typically within $\pm 0.73\text{V}$ of GND. Driving the $\overline{\text{SHDN}}$ pin typically more than $\pm 1.21\text{V}$ turns the LT3015 ON. Drive the $\overline{\text{SHDN}}$ pin with either a logic gate or with open collector/drain logic using a pull-up resistor. The resistor supplies the pull-up current of the open collector/drain gate, typically several microamperes. The typical SHDN pin current is $2.8\mu\text{A}$ out of the pin (for negative logic) or $17\mu\text{A}$ into the pin (for positive logic). If the $\overline{\text{SHDN}}$ function is unused, connect the $\overline{\text{SHDN}}$ pin to V_{IN} to turn the device ON. If the $\overline{\text{SHDN}}$ pin is floated, then the LT3015 is OFF. A parasitic diode exists between $\overline{\text{SHDN}}$ and IN of the LT3015. Therefore, do not drive the $\overline{\text{SHDN}}$ pin more than 0.3V below IN during normal operation or during a fault condition. The $\overline{\text{SHDN}}$ pin can also be used to set a programmable undervoltage lockout (UVLO) threshold for the regulator input supply.

GND (Pins 4, 5 / 6, 7 / 2 / 2): Ground. Tie all GND pin(s) together and tie the bottom of the output voltage setting resistor divider directly to the GND pin(s) for optimum load regulation performance.

ADJ (Pin 6 / 8 / 4 / 4): Adjust. For the adjustable voltage version, this pin is the error amplifier's non-inverting input.

It has a typical bias current of 30nA that flows into the pin. The ADJ pin reference voltage is -1.22V referred to GND, and the output voltage range is -1.22V to -29.5V . A parasitic substrate diode exists between ADJ and IN of the LT3015. Therefore, do not drive ADJ more than 0.3V below IN during normal operation or during a fault condition.

SENSE (Pin 6 / 8 / 4 / 4): Sense. For the fixed voltage versions of the LT3015 (LT3015-2.5/LT3015-3/LT3015-3.3/LT3015-5/LT3015-12/LT3015-15), the SENSE pin connects to the non-inverting input of the error amplifier through an internal resistor divider network. Optimum regulation is obtained when the SENSE pin is connected to the OUT pin of the regulator. In critical applications, small voltage drops are caused by the resistance (R_p) of PCB traces between the regulator and the load. These drops can be eliminated by connecting the SENSE pin to the output at the load as shown in Figure 1 (Kelvin Sense Connection). Note that the voltage drop across the external PCB traces will add to the dropout voltage of the regulator. The SENSE pin bias current is $100\mu\text{A}$ at the nominal output voltage. A parasitic diode exists between SENSE and IN of the LT3015. Therefore, do not drive SENSE more than 0.3V below IN during normal operation or during a fault condition.

OUT (Pins 7, 8 / 9, 10, 11, 12 / 5 / 5): Output. These pins supply power to the load. Tie all OUT pins together for best performance. Use a minimum output capacitor of $10\mu\text{F}$ with an ESR less than $500\text{m}\Omega$ to prevent oscillations. Large load transient applications require larger output capacitors to limit peak voltage transients. See the Applications Information section for more information on output capacitance. A parasitic substrate diode exists between OUT and IN of the LT3015. Therefore, do not drive OUT more than 0.3V below IN during normal operation or during a fault condition.

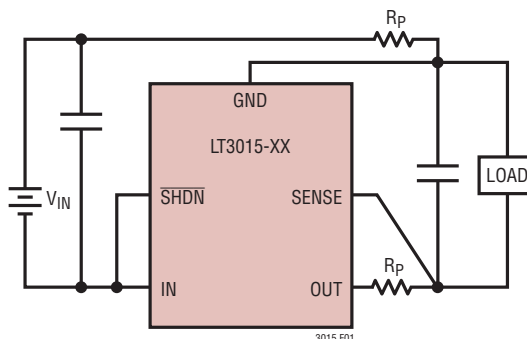
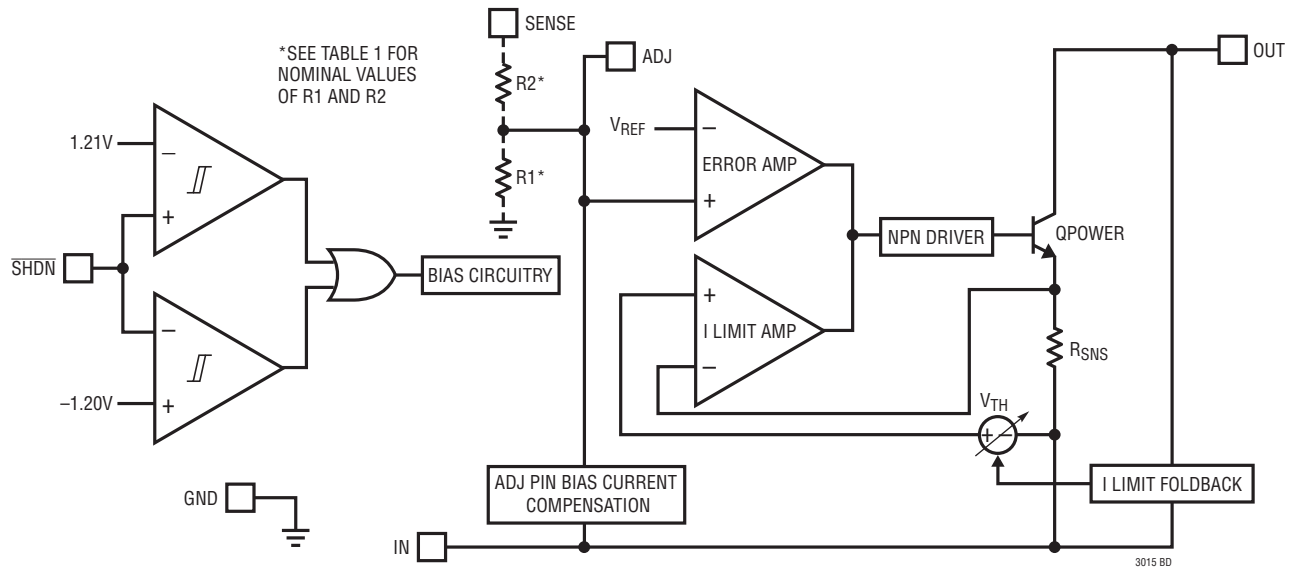

Figure 1. Kelvin Sense Connection

3015fb

BLOCK DIAGRAM



APPLICATIONS INFORMATION

The LT3015 series are 1.5A negative low dropout linear regulators featuring precision current limit and precision bi-directional shutdown. The device supplies up to 1.5A of output load current at a typical dropout voltage of 310mV. Moreover, the low 1.1mA operating quiescent current drops to less than 1µA in shutdown. In addition to low quiescent current, the LT3015 incorporates several protection features that make it ideal for battery powered applications. In dual supply applications where the regulator's load is returned to a positive supply, OUT can be pulled above GND by 30V and still allow the LT3015 to start up and operate.

Adjustable Operation

The LT3015 adjustable version has an output voltage range of -1.22V to -29.3V. Output voltage is set by the ratio of two external resistors as shown in Figure 2. The device regulates the output to maintain the ADJ pin voltage to -1.22V referred to ground. The current in R1 equals -1.22V/R1 and the current in R2 equals the current in R1 plus the ADJ pin bias current. The ADJ pin bias current, 30nA at 25°C, flows into the ADJ pin. Calculate the output voltage using the formula shown in Figure 1. The value of R1 should be less than 50k to minimize errors in the output voltage created by the ADJ pin bias current. Note that in shutdown, the output is off and the divider current

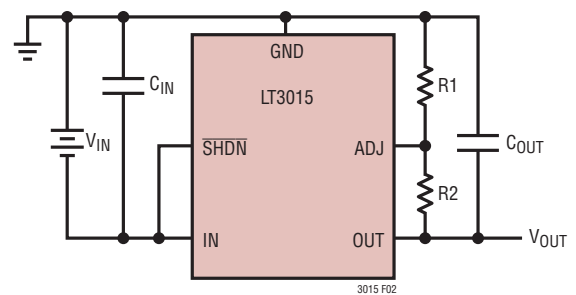

$$V_{OUT} = -1.22V \left(1 + \frac{R2}{R1} \right) + (I_{ADJ})(R2)$$

$$V_{ADJ} = -1.22V \text{ AND } I_{ADJ} = 30nA \text{ AT } 25^\circ C$$

$$\text{OUTPUT RANGE} = -1.22 \text{ TO } -29.5V$$

Figure 2. Adjustable Operation

is zero. Curves of ADJ Pin Voltage vs Temperature, ADJ Pin Bias Current vs Temperature and ADJ Pin Bias Current vs Input Voltage appear in the Typical Performance Characteristics section.

The adjustable device is tested and specified with the ADJ pin tied to the OUT pin for a -1.22V output voltage. Specifications for output voltages greater than -1.22V are proportional to the ratio of the desired V_{OUT} to -1.22V ($V_{OUT}/-1.22V$). For example, load regulation for an output current change of -1mA to -1.5A is typically 2mV at $V_{OUT} = -1.22V$. At $V_{OUT} = -5V$, load regulation equals:

$$(-5V/-1.22V) \cdot (2mV) = 8.2mV$$

APPLICATIONS INFORMATION

Table 1 shows 1% resistor divider values for some common output voltages with a resistor divider current of approximately 100 μ A.

Table 1. Output Voltage Resistor Divider Values

V _{OUT} (V)	R1 (k Ω)	R2 (k Ω)
-2.5	12.1	12.7
-3.0	12.1	17.8
-3.3	12.1	20.5
-5.0	12.1	37.4
-12.0	12.1	107
-15.0	12.4	140

Feedforward Capacitance: Output Voltage Noise, Transient Performance, and PSRR

The LT3015 regulators provide low output voltage noise over the 10Hz to 100kHz bandwidth while operating at full load current. Output voltage noise is approximately 240nV/ $\sqrt{\text{Hz}}$ over this frequency while operating in unity-gain configuration. For higher output voltages (using a resistor divider), the output voltage noise gains up accordingly. To lower the output voltage noise for higher output voltages, include a feedforward capacitor (C_{FF}) from V_{OUT} to V_{ADJ} . A good quality, low leakage, capacitor is recommended. This capacitor bypasses the resistor divider network at high frequencies; and hence, reduces the output noise. With the use of a 10nF feedforward capacitor, the output noise decreases from 220 μ V_{RMS} to 70 μ V_{RMS} when the output voltage is set to -5V by a 100 μ A feedback resistor divider.

Higher values of output voltage noise are often measured if care is not exercised with regard to circuit layout and testing. Crosstalk from nearby traces induces unwanted noise onto the LT3015's output. Moreover, power supply ripple rejection (PSRR) must also be considered, as the LT3015 does not exhibit unlimited PSRR; and thus, a small portion of the input noise propagates to the output.

Using a feedforward capacitor (C_{FF}) from V_{OUT} to V_{ADJ} has the added benefit of improving transient response and PSRR for output voltages greater than -1.22V. With no feedforward capacitor, the response and settling times will increase as the output voltage is raised above -1.22V. Use the equation in Figure 3 to determine the minimum value of C_{FF} to achieve a transient (and noise) performance that is similar

to -1.22V output voltage performance regardless of the chosen output voltage (see Transient Response and Output Noise in the Typical Performance Characteristics section).

It is important to note that the start-up time is affected by the use of a feedforward capacitor. Start-up time is directly proportional to the size of the feedforward capacitor and the output voltage, and is inversely proportional to the feedback resistor divider current. In particular, it slows to 860 μ s with a 10nF feedforward capacitor and a 10 μ F output capacitor for an output voltage set to -5V by a 100 μ A feedback resistor divider current.

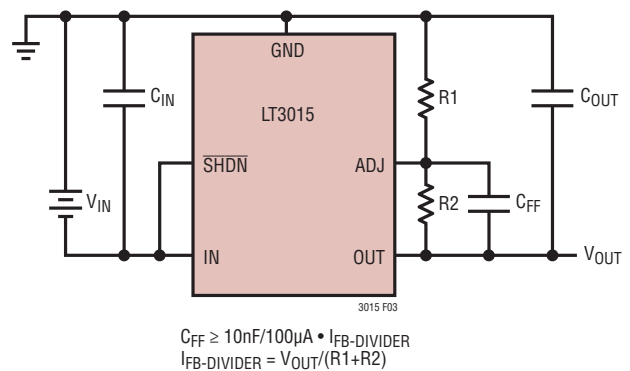

Figure 3. Feedforward Capacitor for Fast Transient Response, Low Noise, and High PSRR

Output Capacitance and Transient Performance

The LT3015 regulators are stable with a wide range of output capacitors. The ESR of the output capacitor affects stability, most notably with small capacitors. Use a minimum output capacitor of 10 μ F with an ESR of 500m Ω or less to prevent oscillations. The LT3015's load transient response is a function of output capacitance. Larger values of output capacitance decrease the peak deviations and provide improved transient response for larger load current changes.

Extra consideration must be given to the use of ceramic capacitors. Ceramic capacitors are manufactured with a variety of dielectrics, each with different behavior across temperature and applied voltage. The most common dielectrics used are specified with EIA temperature characteristic codes of Z5U, Y5V, X5R, and X7R. The Z5U and Y5V dielectrics are good for providing high capacitances in a small package, but they tend to have strong voltage and temperature coefficients as shown in Figures 4 and 5.

3015fb

APPLICATIONS INFORMATION

When used with a 5V regulator, a 16V 10 μ F Y5V capacitor can exhibit an effective value as low as 1 μ F to 2 μ F for the DC bias voltage applied and over the operating temperature range. The X5R and X7R dielectrics result in more stable characteristics and are more suitable for use as the output capacitor. The X7R type has better stability across temperature, while the X5R is less expensive and is available in higher values. Care still must be exercised when using X5R and X7R capacitors; the X5R and X7R codes only specify operating temperature range and maximum capacitance change over temperature. Capacitance change due to DC bias with X5R and X7R capacitors is better than Y5V and Z5U capacitors, but can still be significant enough to drop capacitor values below appropriate levels. Capacitor DC bias characteristics tend to improve as component case size increases, but expected capacitance at operating voltage should be verified in situ for all applications.

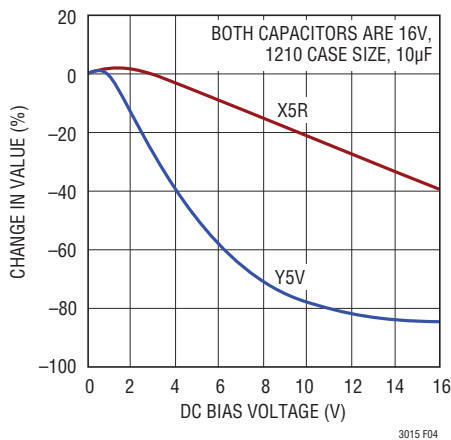

Figure 4. Ceramic Capacitor DC Bias Characteristics

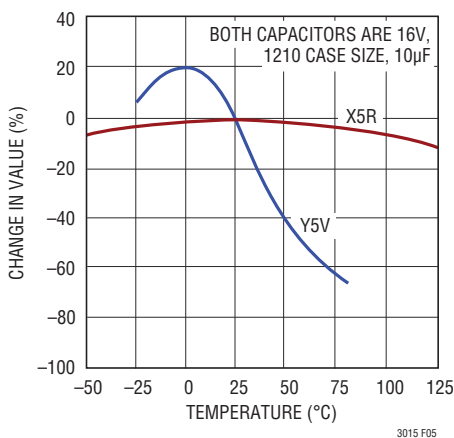

Figure 5. Ceramic Capacitor Temperature Characteristics

Voltage and temperature coefficients are not the only sources of problems. Some ceramic capacitors have a piezoelectric response. A piezoelectric device generates voltage across its terminals due to mechanical stress, similar to the way a piezoelectric microphone works. For a ceramic capacitor, the stress can be induced by vibrations in the system or thermal transients. The resulting voltages produced can cause appreciable amounts of noise. A ceramic capacitor produced the trace in Figure 6 in response to light tapping from a pencil. Similar vibration induced behavior can masquerade as increased output voltage noise.

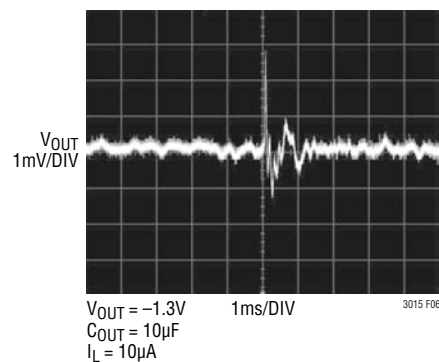

Figure 6. Noise Resulting from Tapping on a Ceramic Capacitor

Overload Recovery

Like many IC power regulators, the LT3015 has safe operating area protection. The safe operating area protection activates at IN-to-OUT differential voltages greater than 8V. The safe area protection decreases current limit as the IN-to-OUT differential voltage increases and keeps the power transistor inside a safe operating region for all values of forward input-to-output voltage up to the LT3015's Absolute Maximum Ratings.

When power is first applied and input voltage rises, the output follows the input and keeps the IN-to-OUT differential voltage small, allowing the regulator to supply large output currents and start-up into high current loads. With a high input voltage, a problem can occur wherein removal of an output short does not allow the output voltage to fully recover. Other LTC negative linear regulators such as the LT1175 and LT1964 also exhibit this phenomenon, so it is not unique to the LT3015.

APPLICATIONS INFORMATION

The problem occurs with a heavy output load when input voltage is high and output voltage is low. Such situations occur easily after the removal of a short-circuit or if the shutdown pin is pulled high after the input voltage has already been turned on. The load line for such a load intersects the output current curve at two points. If this happens, the regulator has two stable output operating points. With this double intersection, the input power supply may need to be cycled down to zero and brought up again to make the output recover.

Shutdown/UVLO

The $\overline{\text{SHDN}}$ pin is used to put the LT3015 into a micropower shutdown state. The LT3015 has an accurate -1.20V threshold (during turn-on) on the $\overline{\text{SHDN}}$ pin. This threshold can be used in conjunction with a resistor divider from the system input supply to define an accurate undervoltage lockout (UVLO) threshold for the regulator. The $\overline{\text{SHDN}}$ pin current (at the threshold) needs to be considered when determining the resistor divider network.

Thermal Considerations

The LT3015's maximum rated junction temperature of 125°C limits its power handling capability. Two components comprise the power dissipated by the device:

1. Output current multiplied by the input-to-output differential voltage: $I_{\text{OUT}} \cdot (V_{\text{IN}} - V_{\text{OUT}})$ and
2. GND pin current multiplied by the input voltage: $I_{\text{GND}} \cdot V_{\text{IN}}$

Determine GND pin current using the GND Pin Current curves in the Typical Performance Characteristics section. Total power dissipation is the sum of the above two components.

The LT3015 regulators incorporate a thermal shutdown circuit designed to protect the device during overload conditions. The typical thermal shutdown temperature is 165°C and the circuit incorporates about 8°C of hysteresis. For continuous normal conditions, do not exceed the maximum junction temperature rating of 125°C . Carefully consider all sources of thermal resistance from junction to ambient, including other heat sources mounted in close proximity to the LT3015.

The undersides of the DFN and MSOP packages have exposed metal from the lead frame to the die attachment. Both packages allow heat to directly transfer from the die junction to the printed circuit board metal to control maximum operating junction temperature. The dual-in-line pin arrangement allows metal to extend beyond the ends of the package on the topside (component side) of the PCB. Connect this metal to IN on the PCB. The multiple IN and OUT pins of the LT3015 also assist in spreading heat to the PCB.

For surface mount devices, heat sinking is accomplished by using the heat spreading capabilities of the PC board and its copper traces. Copper board stiffeners and plated through-holes can also be used to spread the heat generated by power devices.

Tables 2-4 list thermal resistance as a function of copper area in a fixed board size. All measurements were taken in still air on a 4 layer FR-4 board with 1oz solid internal planes and 2oz top/bottom external trace planes with a total board thickness of 1.6mm. The four layers were electrically isolated with no thermal vias present. PCB layers, copper weight, board layout and thermal vias will affect the resultant thermal resistance. For more information on thermal resistance and high thermal conductivity test boards, refer to JEDEC standard JESD51, notably JESD51-12 and JESD51-7. Achieving low thermal resistance necessitates attention to detail and careful PCB layout.

APPLICATIONS INFORMATION

Table 2. Measured Thermal Resistance for DFN Package

COPPER AREA		BOARD AREA	THERMAL RESISTANCE (JUNCTION-TO-AMBIENT)
TOP SIDE*	BACKSIDE		
2500mm ²	2500mm ²	2500mm ²	40°C/W
1000mm ²	2500mm ²	2500mm ²	40°C/W
225mm ²	2500mm ²	2500mm ²	41°C/W
100mm ²	2500mm ²	2500mm ²	42°C/W

*Device is mounted on topside

Table 3. Measured Thermal Resistance for MSOP Package

COPPER AREA		BOARD AREA	THERMAL RESISTANCE (JUNCTION-TO-AMBIENT)
TOP SIDE*	BACKSIDE		
2500mm ²	2500mm ²	2500mm ²	37°C/W
1000mm ²	2500mm ²	2500mm ²	37°C/W
225mm ²	2500mm ²	2500mm ²	38°C/W
100mm ²	2500mm ²	2500mm ²	40°C/W

*Device is mounted on topside

Table 4. Measured Thermal Resistance for DD-Pak Package

COPPER AREA		BOARD AREA	THERMAL RESISTANCE (JUNCTION-TO-AMBIENT)
TOP SIDE*	BACKSIDE		
2500mm ²	2500mm ²	2500mm ²	14°C/W
1000mm ²	2500mm ²	2500mm ²	16°C/W
225mm ²	2500mm ²	2500mm ²	19°C/W

*Device is mounted on topside

T Package, 5-Lead TO-220

Thermal Resistance (Junction-to-Case) = 3°C/W

Calculating Junction Temperature

Example: Given an output voltage of -2.5V, an input voltage range of -3.3V ± 5%, an output current range of 1mA to 500mA, and a maximum ambient temperature of 85°C, what is the maximum junction temperature?

The power dissipated by the LT3015 equals:

$$I_{OUT(MAX)} \cdot (V_{IN(MAX)} - V_{OUT}) + I_{GND} \cdot (V_{IN(MAX)})$$

where:

$$I_{OUT(MAX)} = -500\text{mA}$$

$$V_{IN(MAX)} = -3.465\text{V}$$

$$I_{GND} \text{ at } (I_{OUT} = -500\text{mA}, V_{IN} = -3.465\text{V}) = -6.5\text{mA}$$

Thus:

$$P = -500\text{mA}(-3.465\text{V} + 2.5\text{V}) + -6.5\text{mA} \cdot (-3.465\text{V}) = 0.505\text{W}$$

Using a DFN package, the thermal resistance is in the range of 40°C/W to 42°C/W depending on the copper area. Therefore, the junction temperature rise above ambient approximately equals:

$$0.505\text{W} \cdot 41^\circ\text{C/W} = 20.7^\circ\text{C}$$

The maximum junction temperature equals the maximum ambient temperature plus the maximum junction temperature rise above ambient or:

$$T_{JMAX} = 85^\circ\text{C} + 20.7^\circ\text{C} = 105.7^\circ\text{C}$$

Protection Features

The LT3015 incorporates several protection features that make it ideal for use in battery-powered applications. In addition to the normal protection features associated with monolithic regulators, such as current limiting and thermal limiting, the device protects itself against reverse input voltages and reverse output voltages.

Precision current limit and thermal overload protections are intended to protect the LT3015 against current overload conditions at the output of the device. For normal operation, do not allow the the junction temperature to exceed 125°C.

Pulling the LT3015's output above ground induces no damage to the part. If IN is left open circuit or grounded, OUT can be pulled above GND by 30V. In addition, OUT acts like an open circuit, i.e. no current flows into the pin. If IN is powered by a voltage source, OUT sinks the LT3015's short-circuit current and protects itself by thermal limiting. In this case, grounding the SHDN pin turns off the device and stops OUT from sinking the short-circuit current.

TYPICAL APPLICATIONS

Adjustable Current Sink

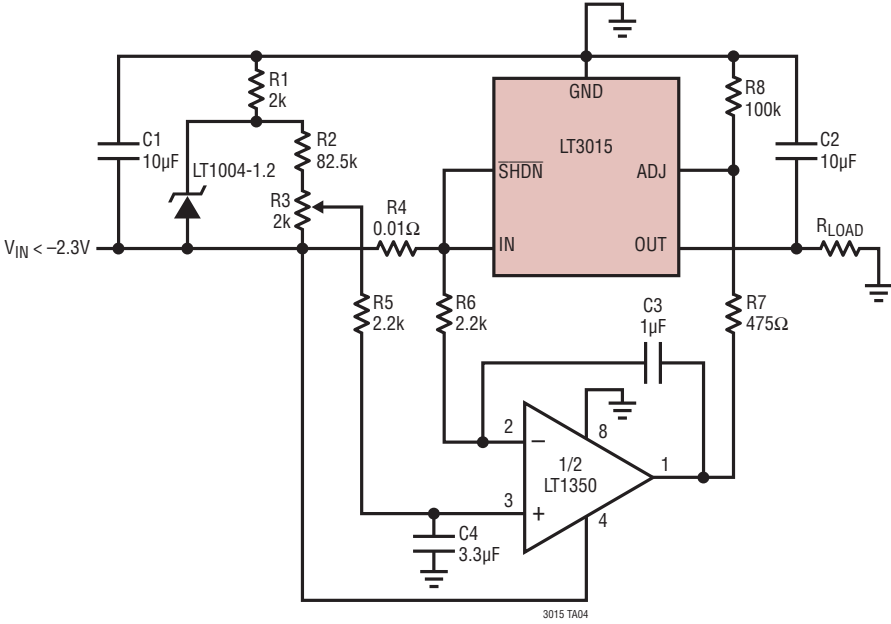

NOTE: ADJUST R3 FOR 0 TO -1.5A CONSTANT CURRENT

PACKAGE DESCRIPTION

Please refer to <http://www.linear.com/designtools/packaging/> for the most recent package drawings.

DD Package
8-Lead Plastic DFN (3mm × 3mm)
 (Reference LTC DWG # 05-08-1698 Rev C)

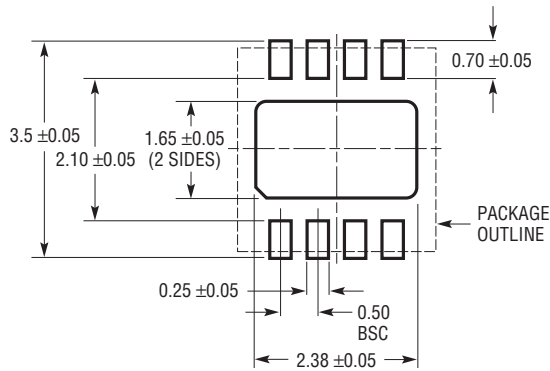

RECOMMENDED SOLDER PAD PITCH AND DIMENSIONS
 APPLY SOLDER MASK TO AREAS THAT ARE NOT SOLDERED

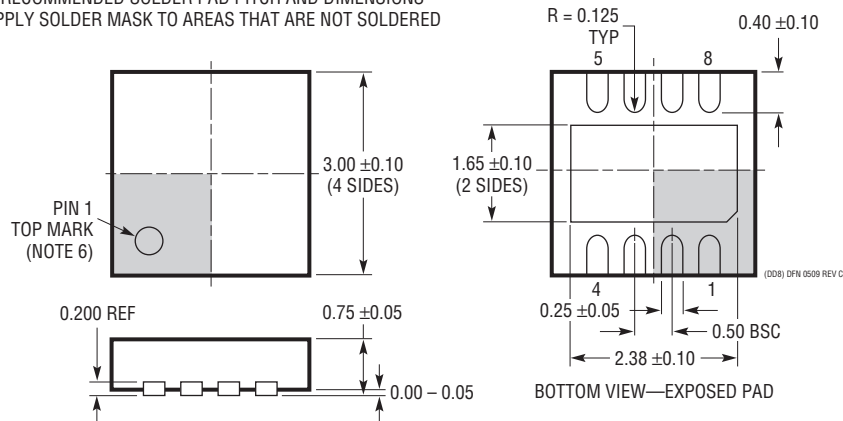

- NOTE:
1. DRAWING TO BE MADE A JEDEC PACKAGE OUTLINE M0-229 VARIATION OF (WEED-1)
 2. DRAWING NOT TO SCALE
 3. ALL DIMENSIONS ARE IN MILLIMETERS
 4. DIMENSIONS OF EXPOSED PAD ON BOTTOM OF PACKAGE DO NOT INCLUDE MOLD FLASH. MOLD FLASH, IF PRESENT, SHALL NOT EXCEED 0.15mm ON ANY SIDE
 5. EXPOSED PAD SHALL BE SOLDER PLATED
 6. SHADED AREA IS ONLY A REFERENCE FOR PIN 1 LOCATION ON TOP AND BOTTOM OF PACKAGE

PACKAGE DESCRIPTION

Please refer to <http://www.linear.com/designtools/packaging/> for the most recent package drawings.

MSE Package 12-Lead Plastic MSOP, Exposed Die Pad (Reference LTC DWG # 05-08-1666 Rev F)

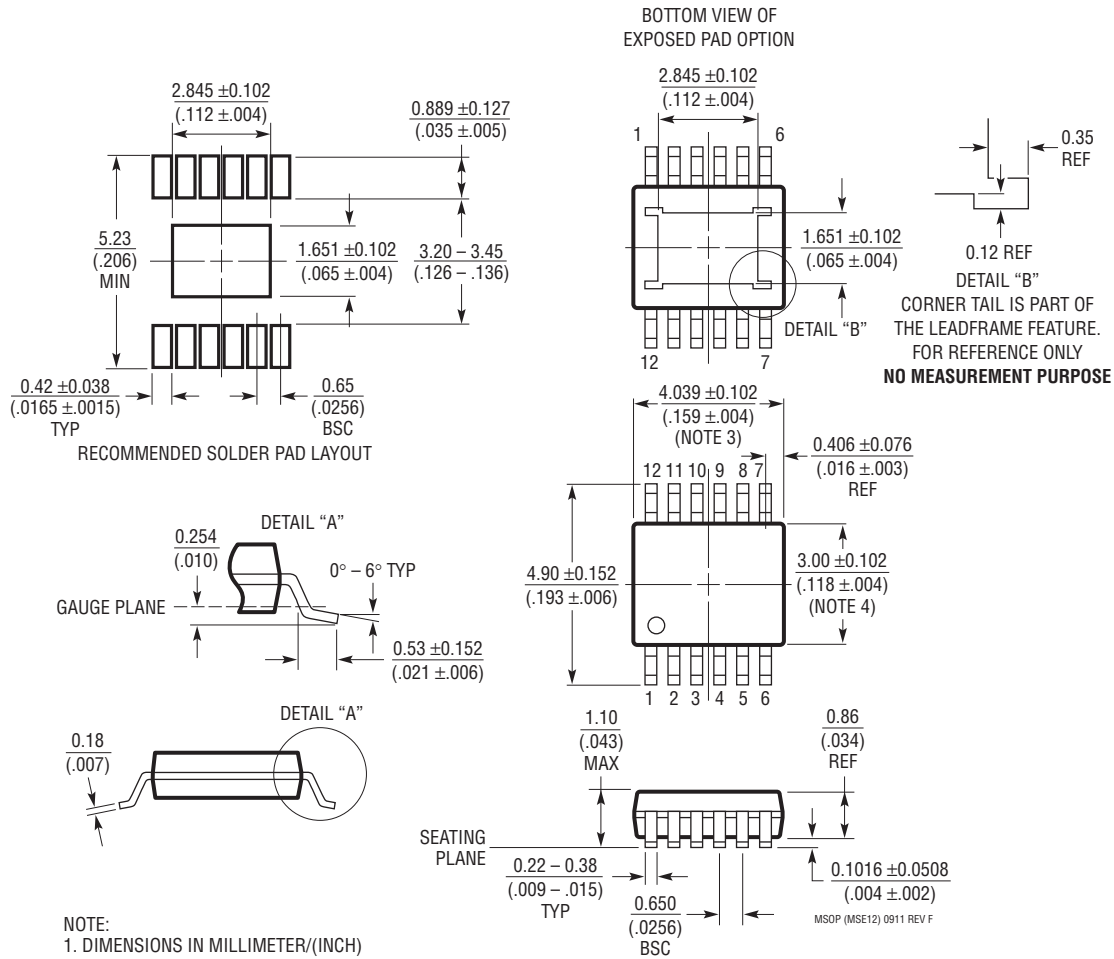

NOTE:

1. DIMENSIONS IN MILLIMETER/(INCH)
2. DRAWING NOT TO SCALE
3. DIMENSION DOES NOT INCLUDE MOLD FLASH, PROTRUSIONS OR GATE BURRS.
MOLD FLASH, PROTRUSIONS OR GATE BURRS SHALL NOT EXCEED 0.152mm (.006") PER SIDE
4. DIMENSION DOES NOT INCLUDE INTERLEAD FLASH OR PROTRUSIONS.
INTERLEAD FLASH OR PROTRUSIONS SHALL NOT EXCEED 0.152mm (.006") PER SIDE
5. LEAD COPLANARITY (BOTTOM OF LEADS AFTER FORMING) SHALL BE 0.102mm (.004") MAX
6. EXPOSED PAD DIMENSION DOES INCLUDE MOLD FLASH. MOLD FLASH ON E-PAD SHALL NOT EXCEED 0.254mm (.010") PER SIDE.

PACKAGE DESCRIPTION

Please refer to <http://www.linear.com/designtools/packaging/> for the most recent package drawings.

Q Package 5-Lead Plastic DD Pak (Reference LTC DWG # 05-08-1461 Rev F)

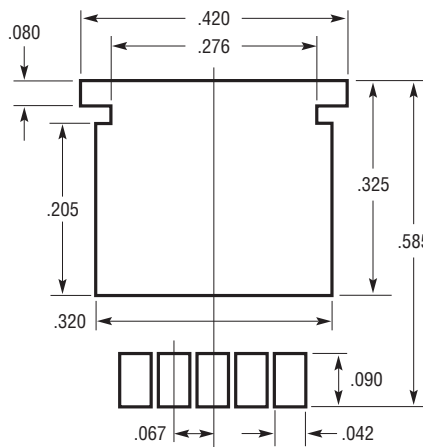
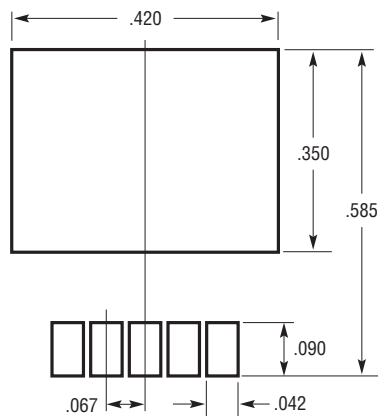
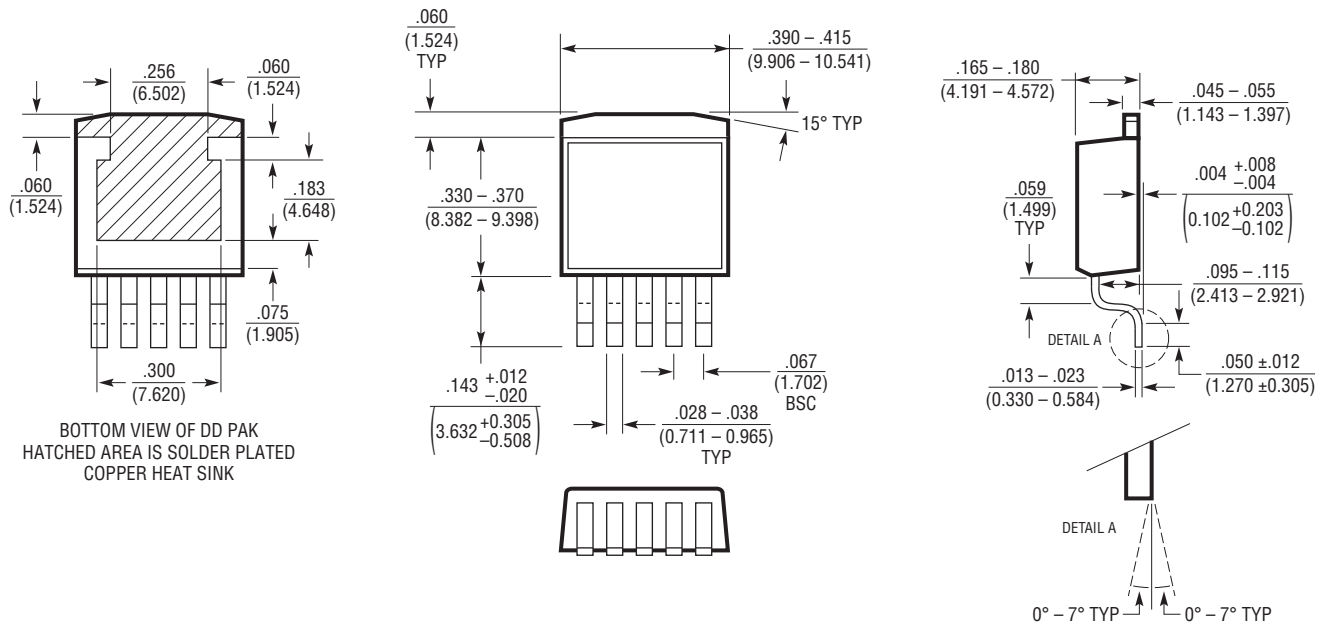

Q(DD5) 0811 REV F

PACKAGE DESCRIPTION

Please refer to <http://www.linear.com/designtools/packaging/> for the most recent package drawings.

T Package 5-Lead Plastic TO-220 (Standard) (Reference LTC DWG # 05-08-1421)

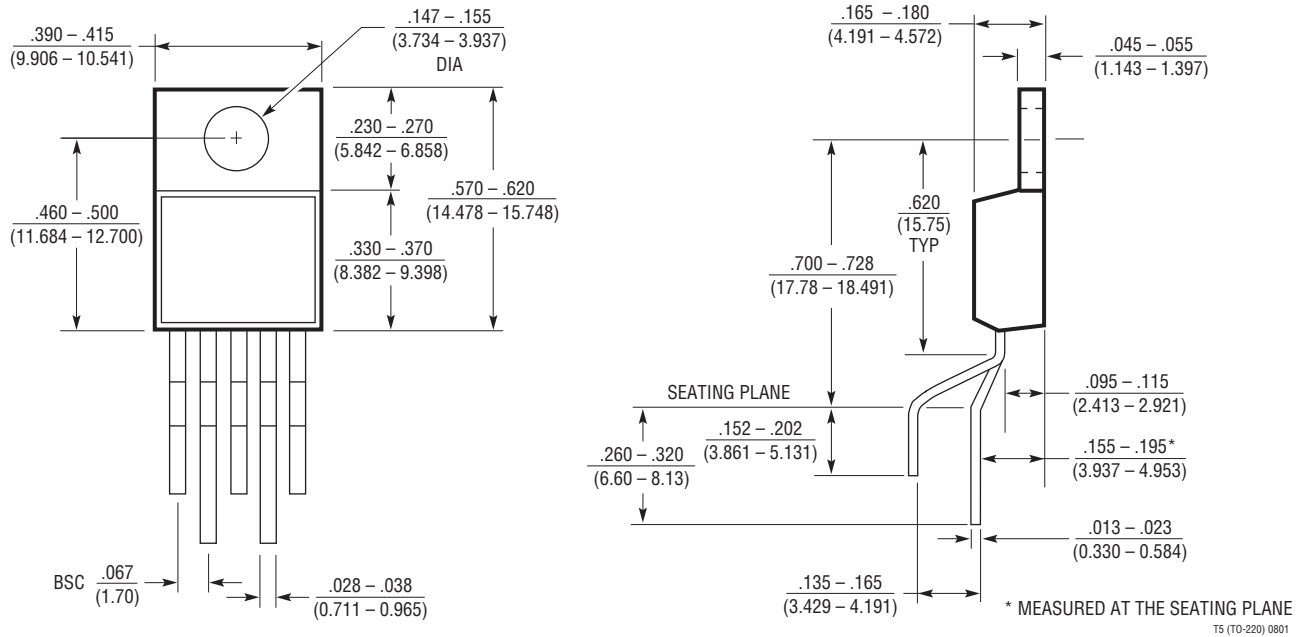

REVISION HISTORY

REV	DATE	DESCRIPTION	PAGE NUMBER
A	12/11	Revised entire data sheet to include fixed output voltages.	1 - 26
B	4/12	Clarified conditions of "RMS Output Noise vs Load Current" graph	11