

## FEATURES

- **Highly Integrated IC in 2mm × 3mm DFN Package Reduces Solution Size**
- **Uses Small Transformers:**  
5.8mm × 5.8mm × 3mm
- **Fast Photoflash Charge Times:**  
4.6s for LT3484-0 (0V to 320V, 100μF, V<sub>IN</sub> = 3.6V)  
5.7s for LT3484-2 (0V to 320V, 100μF, V<sub>IN</sub> = 3.6V)  
5.5s for LT3484-1 (0V to 320V, 50μF, V<sub>IN</sub> = 3.6V)
- **Operates from Two AA Batteries, or Any Supply from 1.8V up to 16V**
- **Controlled Average Input Current**  
500mA (LT3484-0)  
350mA (LT3484-2)  
225mA (LT3484-1)
- No Output Voltage Divider Needed
- No External Schottky Diode Required
- Charges Any Size Photoflash Capacitor
- Available in 6-Lead 2mm × 3mm DFN Package

## APPLICATIONS

- Digital Camera and Cell Phone Flash Charger

## DESCRIPTION

The LT<sup>®</sup>3484 family of photoflash capacitor charger ICs is designed for use in digital camera and mobile phone applications where space is at a premium. The LT3484's patented control technique allows it to use extremely small transformers, and the improved NPN power switch requires no external Schottky diode clamp, reducing solution size. Output voltage detection requires no external circuitry as the transformer turns ratio determines final charge voltage.

The devices feature a V<sub>BAT</sub> pin, which allows the use of 2 alkaline cells to charge the capacitor. The LT3484-0, -2 and -1 have primary current limits of 1.4A, 1A and 0.7A respectively, resulting in tightly controlled average input current of 500mA, 350mA and 225mA respectively. The three versions are otherwise identical.

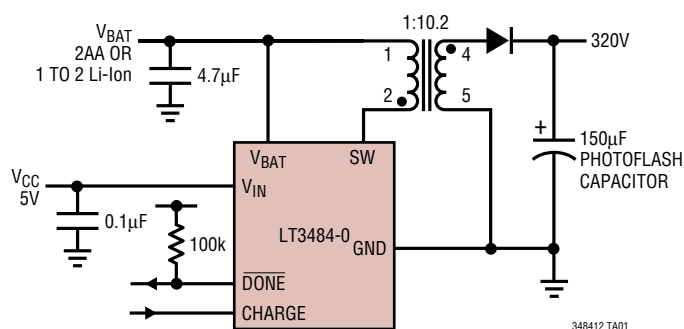
The CHARGE pin gives full control of the part to the user. Driving CHARGE low puts the part in shutdown. The DONE pin indicates when the part has completed charging. The LT3484 series of parts are housed in a tiny low profile 2mm × 3mm DFN package.

LT, LTC and LT are registered trademarks of Linear Technology Corporation. All other trademarks are the property of their respective owners. Protected by U.S. Patents including 6636021.

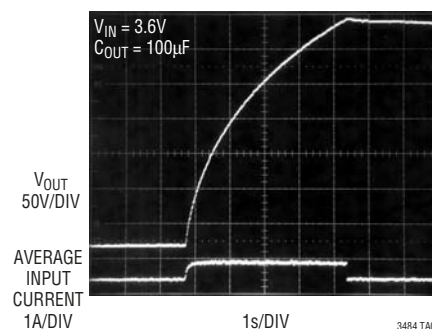
## TYPICAL APPLICATION

### LT3484-0 Photoflash Charger Uses High Efficiency 3mm Tall Transformers

**DANGER HIGH VOLTAGE – OPERATION BY HIGH VOLTAGE TRAINED PERSONNEL ONLY**



### LT3484-0 Charging Waveform



# LT3484-0/LT3484-1/LT3484-2

## ABSOLUTE MAXIMUM RATINGS

(Note 1)

$V_{IN}$ Voltage .....	16V
$V_{BAT}$ Voltage .....	16V
SW Voltage .....	-1V to 50V
SW Pin Negative Current .....	-0.5A
CHARGE Voltage .....	10V
DONE Voltage .....	10V
Current into DONE Pin .....	$\pm 1$ mA
Maximum Junction Temperature .....	125°C
Operating Temperature Range .....	-40°C to 85°C
Storage Temperature Range .....	-65°C to 150°C

## PACKAGE/ORDER INFORMATION

<p>TOP VIEW</p> <p>DCB6 PACKAGE 6-LEAD (2mm × 3mm) PLASTIC DFN <math>T_{JMAX} = 125^{\circ}\text{C}</math> <math>\theta_{JA} = 73.5^{\circ}\text{C/W}</math> EXPOSED PAD (PIN 7) IS GND, MUST BE SOLDERED TO PCB</p>	
ORDER PART NUMBER	DCB6 PART MARKING
LT3484EDCB-0	LBTM
LT3484EDCB-1	LBTN
LT3484EDCB-2	LBTP
<p><b>Order Options</b> Tape and Reel: Add #TR Lead Free: Add #PBF Lead Free Tape and Reel: Add #TRPBF Lead Free Part Marking: <a href="http://www.linear.com/leadfree/">http://www.linear.com/leadfree/</a></p>	

Consult LTC Marketing for parts specified with wider operating temperature ranges.

## ELECTRICAL CHARACTERISTICS

The ● denotes the specifications which apply over the full operating temperature range, otherwise specifications are at  $T_A = 25^{\circ}\text{C}$ .  $V_{IN} = V_{BAT} = V_{CHARGE} = 3\text{V}$ , unless otherwise noted.

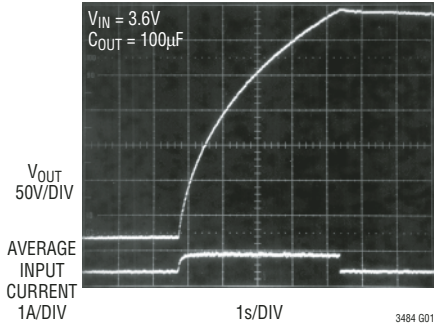
PARAMETER	CONDITIONS	MIN	TYP	MAX	UNITS	
Quiescent Current	Not Switching $V_{CHARGE} = 0\text{V}$		5	8	mA	
			0	1	$\mu\text{A}$	
$V_{CC}$ Voltage Range		● 2.5		16	V	
$V_{BAT}$ Voltage Range		● 1.7		16	V	
Switch Current Limit	LT3484-0		1.1	1.2	1.3	A
	LT3484-2		0.75	0.85	0.95	A
	LT3484-1		0.45	0.55	0.65	A
Switch $V_{CESAT}$	LT3484-0, $I_{SW} = 1\text{A}$		330	430	mV	
	LT3484-2, $I_{SW} = 650\text{mA}$		210	280	mV	
	LT3484-1, $I_{SW} = 400\text{mA}$		150	200	mV	
$V_{OUT}$ Comparator Trip Voltage	Measured as $V_{SW} - V_{IN}$	● 31	31.5	32	V	
$V_{OUT}$ Comparator Overdrive	300ns Pulse Width		200	400	mV	
DCM Comparator Trip Voltage	Measured as $V_{SW} - V_{IN}$	● 10	60	120	mV	
CHARGE Pin Current	$V_{CHARGE} = 3\text{V}$ $V_{CHARGE} = 0\text{V}$		65	100	$\mu\text{A}$	
			0	0.1	$\mu\text{A}$	
Switch Leakage Current	$V_{IN} = V_{SW} = 5\text{V}$ , in Shutdown	●	0.01	1	$\mu\text{A}$	
CHARGE Input Voltage High		● 1			V	
CHARGE Input Voltage Low		●		0.3	V	
DONE Output Signal High	100k $\Omega$ from $V_{IN}$ to $\overline{\text{DONE}}$		3		V	
DONE Output Signal Low	33 $\mu\text{A}$ into $\overline{\text{DONE}}$ Pin		100	200	mV	
DONE Leakage Current	$V_{\overline{\text{DONE}}} = 3\text{V}$ , $\overline{\text{DONE}}$ NPN Off		20	100	nA	

**Note 1:** Absolute Maximum Ratings are those values beyond which the life of a device may be impaired.

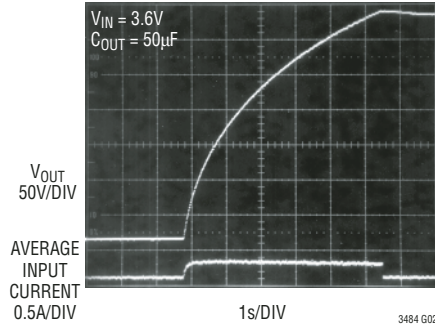
3484012f

**TYPICAL PERFORMANCE CHARACTERISTICS** LT3484-0 curves use the circuit of Figure 6, LT3484-1 curves use the circuit of Figure 7 and LT3484-2 use the circuit of Figure 8,  $T_A = 25^\circ\text{C}$  unless otherwise noted.

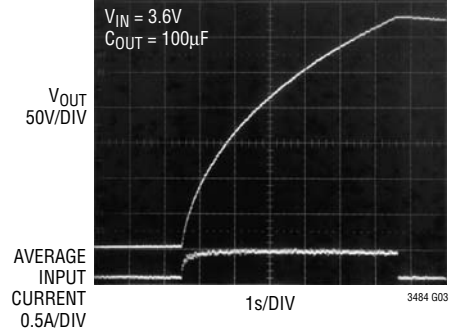
LT3484-0 Charging Waveform



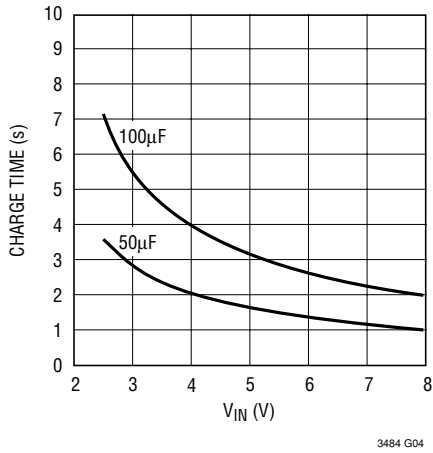
LT3484-1 Charging Waveform



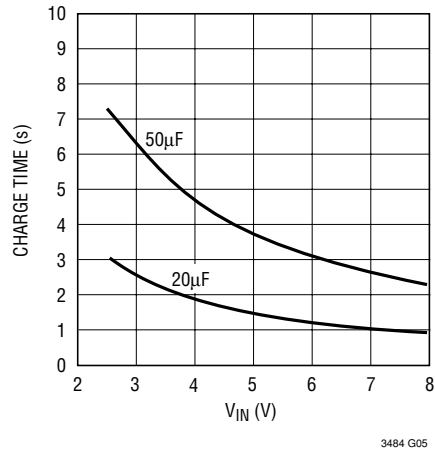
LT3484-2 Charging Waveform



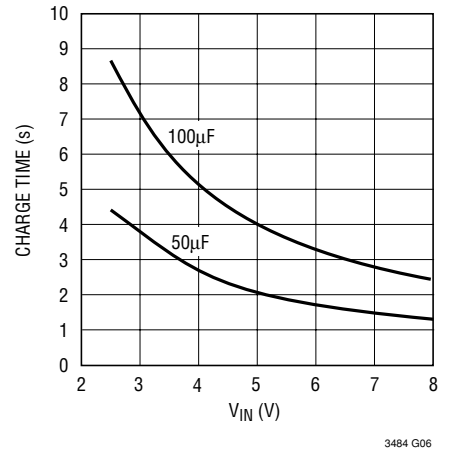
LT3484-0 Charge Time



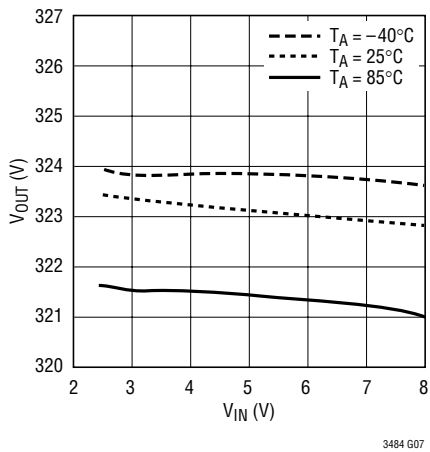
LT3484-1 Charge Time



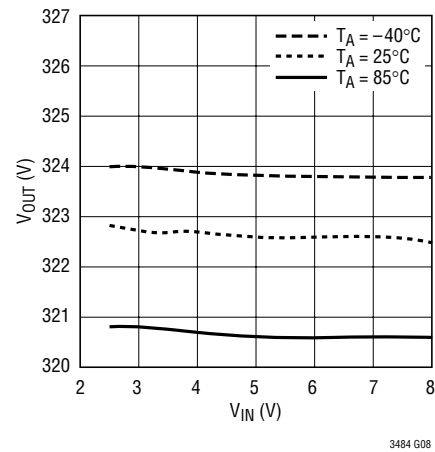
LT3484-2 Charge Time



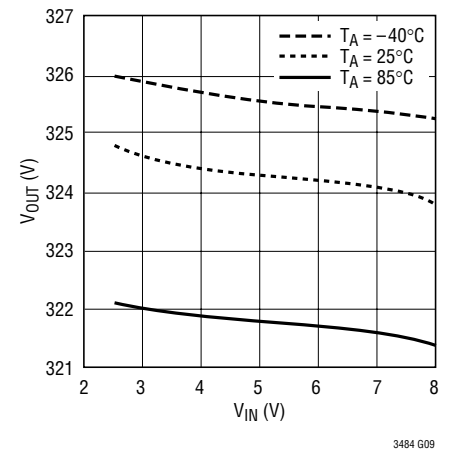
LT3484-0 Output Voltage



LT3484-1 Output Voltage



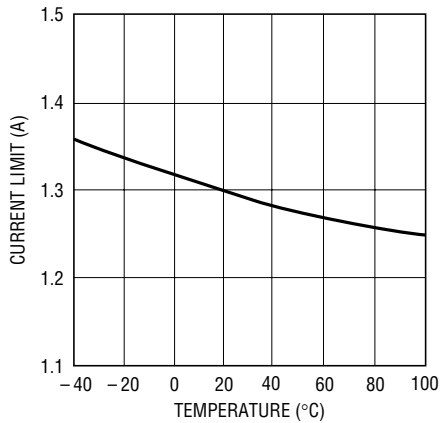
LT3484-2 Output Voltage



# LT3484-0/LT3484-1/LT3484-2

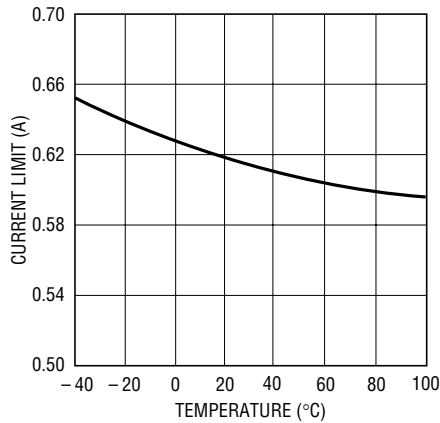
**TYPICAL PERFORMANCE CHARACTERISTICS** LT3484-0 curves use the circuit of Figure 6, LT3484-1 curves use the circuit of Figure 7 and LT3484-2 use the circuit of Figure 8,  $T_A = 25^\circ\text{C}$  unless otherwise noted.

LT3484-0 Switch Current Limit



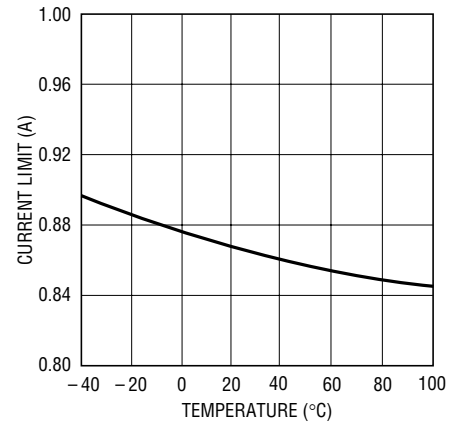
3484 G10

LT3484-1 Switch Current Limit



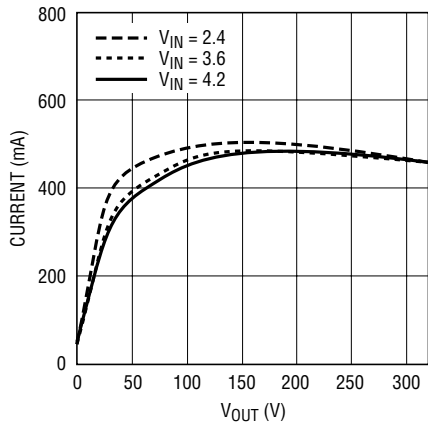
3484 G11

LT3484-2 Switch Current Limit



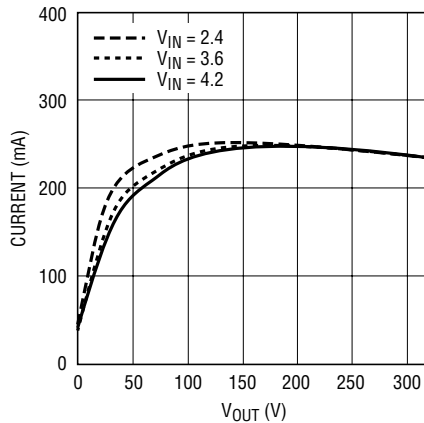
3484 G12

LT3484-0 Input Current



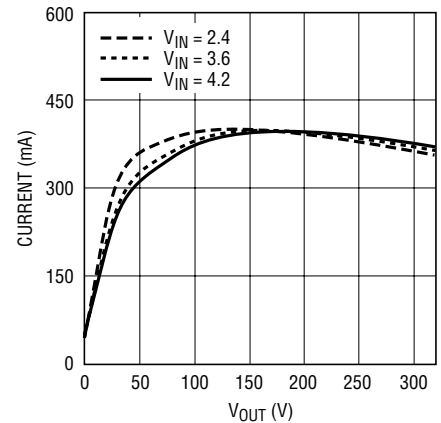
3484 G13

LT3484-1 Input Current



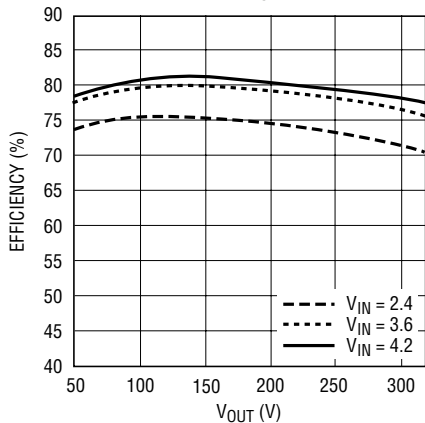
3484 G14

LT3484-2 Input Current



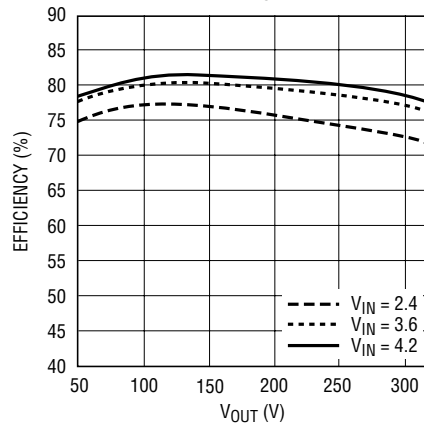
3484 G15

LT3484-0 Efficiency



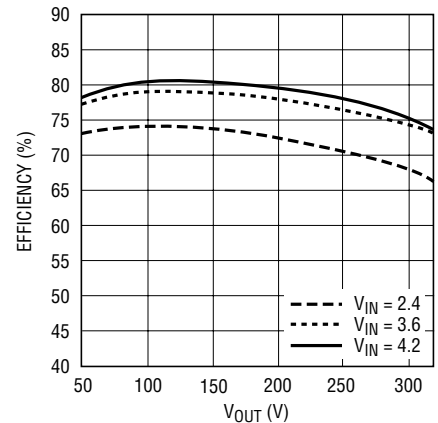
3484 G16

LT3484-1 Efficiency



3484 G17

LT3484-2 Efficiency

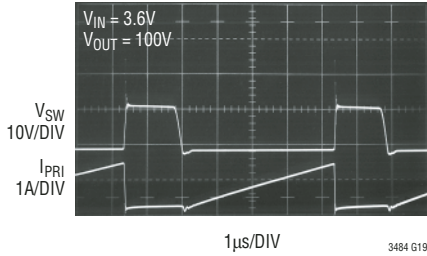


3484 G18

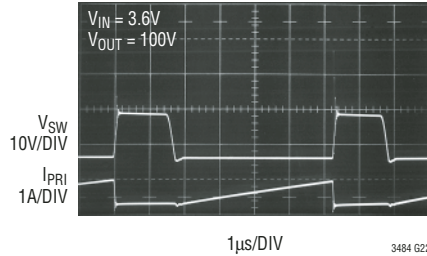
3484012f

**TYPICAL PERFORMANCE CHARACTERISTICS** LT3484-0 curves use the circuit of Figure 6, LT3484-1 curves use the circuit of Figure 7 and LT3484-2 use the circuit of Figure 8,  $T_A = 25^\circ\text{C}$  unless otherwise noted.

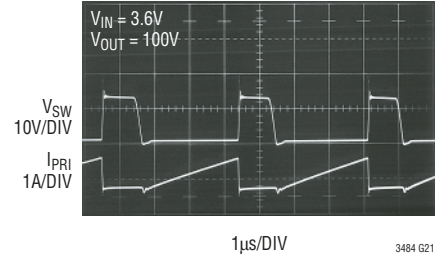
**LT3484-0 Switching Waveform**



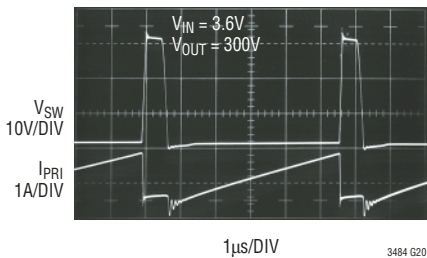
**LT3484-1 Switching Waveform**



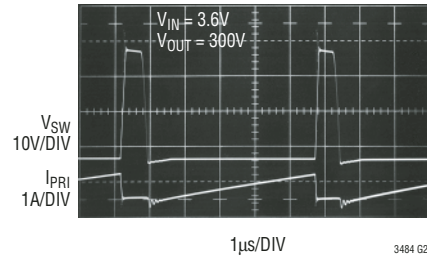
**LT3484-2 Switching Waveform**



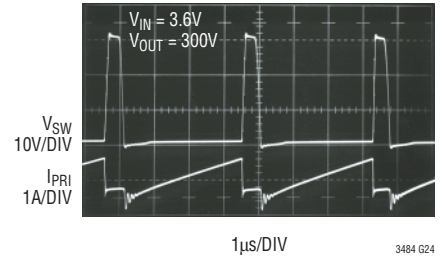
**LT3484-0 Switching Waveform**



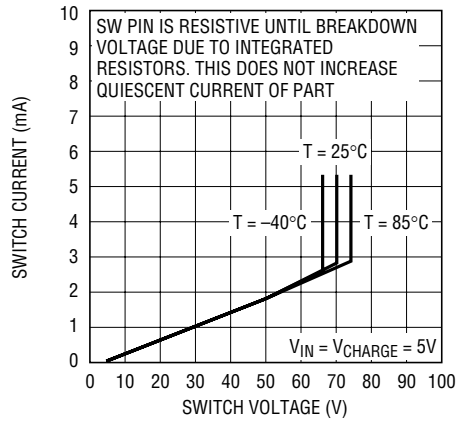
**LT3484-1 Switching Waveform**



**LT3484-2 Switching Waveform**



**LT3484-0/LT3484-1/LT3484-2  
Switch Breakdown Voltage**



## PIN FUNCTIONS

**DONE (Pin 1):** Open NPN Collector Indication Pin. When target output voltage is reached, NPN turns on, pulling Pin 1 low. This pin needs a pull-up resistor or current source.

**CHARGE (Pin 2):** Charge Pin. A low (<0.3V) to high (>1V) transition on this pin puts the part into power delivery mode. Once the target voltage is reached, the part will stop charging the output. Toggle this pin to start charging again. Bringing the pin low (<0.3V) will terminate the power delivery and put the part in shutdown.

**V<sub>IN</sub> (Pin 3):** Input Supply Pin. Must be locally bypassed with a good quality ceramic capacitor. Input supply must be 2.5V or higher.

**SW (Pins 4, 5):** Switch Pins. These are the collector of the internal NPN Power switch. Tie these pins together on the

PC Board. Minimize the metal trace area connected to these pins to minimize EMI. Tie one side of the primary of the transformer to these pins. The target output voltage is set by the turns ratio of the transformer.

Choose Turns Ratio N by the following equation:

$$N = \frac{V_{OUT} + 2}{31.5}$$

where  $V_{OUT}$  is the desired output voltage.

**V<sub>BAT</sub> (Pin 6):** Battery Supply Pin. Must be locally bypassed with a good quality ceramic capacitor. Battery supply must be 1.7V or higher. The other terminal of the transformer primary must be connected to V<sub>BAT</sub>.

**GND (Pin 7):** Ground. Tie directly to local ground plane.

## FUNCTIONAL BLOCK DIAGRAM

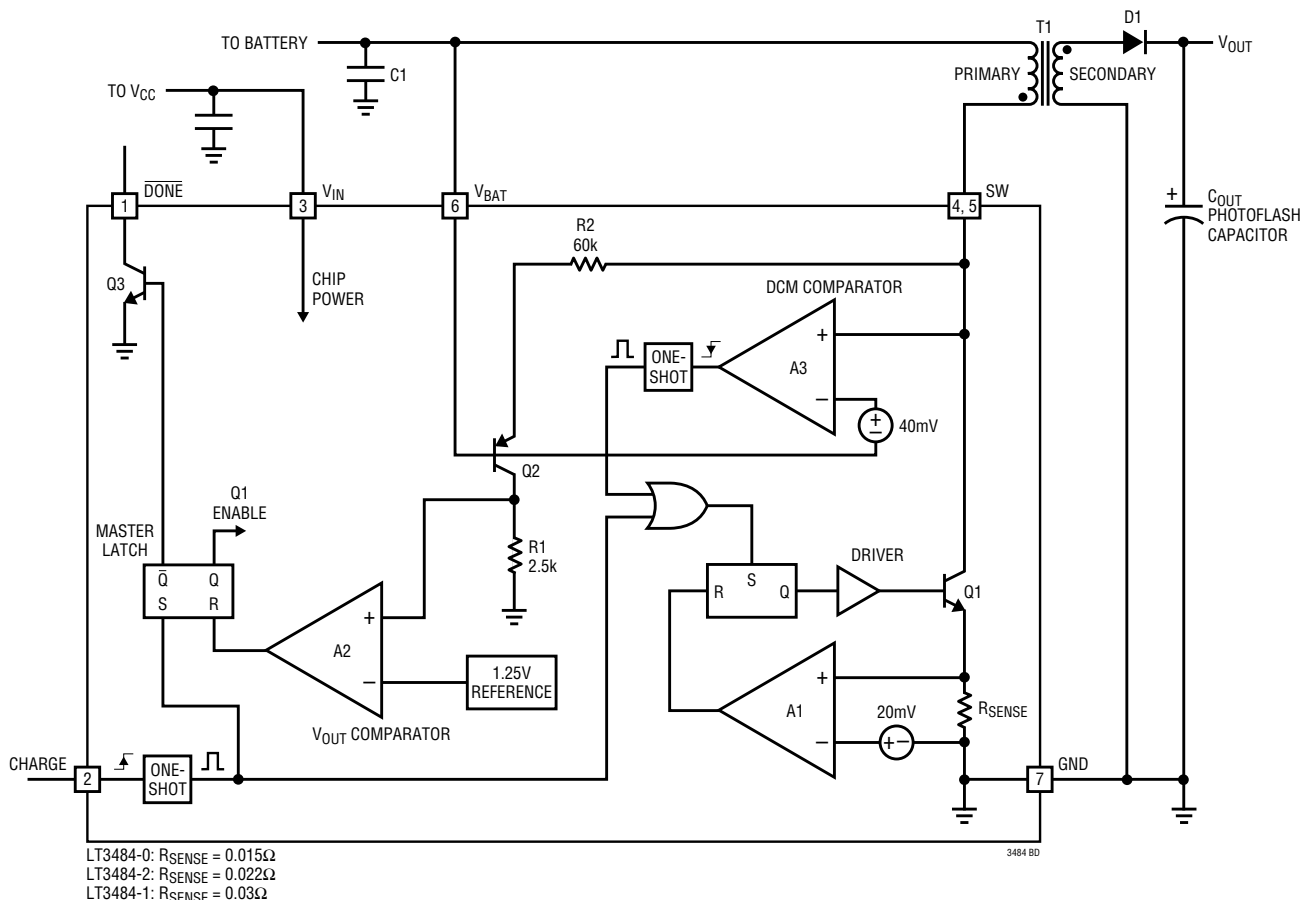


Figure 1

## OPERATION

The LT3484-0/LT3484-1/LT3484-2 are designed to charge photoflash capacitors quickly and efficiently. The operation of the part can be best understood by referring to Figure 1. When the CHARGE pin is first driven high, a one shot sets both SR latches in the correct state. The power NPN device, Q1, turns on and current begins ramping up in the primary of transformer T1. Comparator A1 monitors the switch current and when the peak current reaches 1.4A (LT3484-0), 1A(LT3484-2) or 0.7A (LT3484-1), Q1 is turned off. Since T1 is utilized as a flyback transformer, the flyback pulse on the SW pin will cause the output of A3 to be high. The voltage on the SW pin needs to be at least 40mV higher than  $V_{BAT}$  for this to happen.

During this phase, current is delivered to the photoflash capacitor via the secondary and diode D1. As the secondary current decreases to zero, the SW pin voltage will begin to collapse. When the SW pin voltage drops to 40mV above  $V_{BAT}$  or lower, the output of A3 (DCM Comparator) will go low. This fires a one shot which turns Q1 back on. This cycle will continue to deliver power to the output.

Output voltage detection is accomplished via R2, R1, Q2, and comparator A2 ( $V_{OUT}$  Comparator). Resistors R1 and R2 are sized so that when the SW voltage is 31.5V above  $V_{IN}$ , the output of A2 goes high which resets the master latch. This disables Q1 and halts power delivery. NPN transistor Q3 is turned on pulling the  $\overline{DONE}$  pin low, indicating that the part has finished charging. Power delivery can only be restarted by toggling the CHARGE pin.

The CHARGE pin gives full control of the part to the user. The charging can be halted at any time by bringing the CHARGE pin low. Only when the final output voltage is reached will the  $\overline{DONE}$  pin go low. Figure 2 shows these various modes in action. When CHARGE is first brought high, charging commences. When CHARGE is brought low during charging, the part goes into shutdown and  $V_{OUT}$  no longer rises. When CHARGE is brought high again, charging resumes. When the target  $V_{OUT}$  voltage is reached, the  $\overline{DONE}$  pin goes low and charging stops. Finally the CHARGE pin is brought low again so the part enters shutdown and the  $\overline{DONE}$  pin goes high. Both  $V_{BAT}$  and  $V_{IN}$  have undervoltage lockout (UVLO). When one of these pins goes below its UVLO voltage, the  $\overline{DONE}$  pin goes low. With an insufficient bypass capacitor on  $V_{BAT}$  or  $V_{IN}$ , the ripple on the pin is likely to activate the UVLO and terminate the charge. The application diagrams suggest values adequate for most applications.

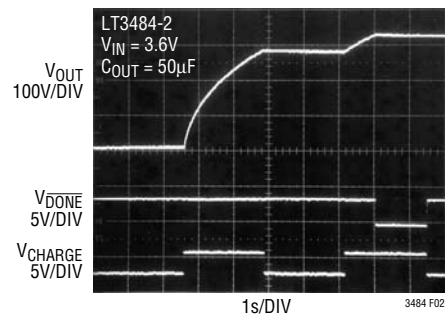


Figure 2. Halting the Charging Cycle with the CHARGE Pin

## APPLICATIONS INFORMATION

### Choosing the Right Device (LT3484-0/LT3484-1/LT3484-2)

The only difference between the three versions of the LT3484 is the peak current level. For the fastest possible charge time, use the LT3484-0. The LT3484-1 has the lowest peak current capability, and is designed for applications that need a more limited drain on the batteries. Due to the lower peak current, the LT3484-1 can use a physically smaller transformer. The LT3484-2 has a current limit in between that of the LT3484-0 and the LT3484-1.

### Transformer Design

The flyback transformer is a key element for any LT3484-0/LT3484-1/LT3484-2 design. It must be designed carefully and checked that it does not cause excessive current or voltage on any pin of the part. The main parameters that need to be designed are shown in Table 1.

The first transformer parameter that needs to be set is the turns ratio N. The LT3484-0/LT3484-1/LT3484-2 accomplish output voltage detection by monitoring the flyback waveform on the SW pin. When the SW voltage reaches 31.5V higher than the  $V_{BAT}$  voltage, the part will halt power delivery. Thus, the choice of N sets the target output

## APPLICATIONS INFORMATION

voltage as it changes the amplitude of the reflected voltage from the output to the SW pin. Choose N according to the following equation:

$$N = \frac{V_{OUT} + 2}{31.5}$$

Where:  $V_{OUT}$  is the desired output voltage. The number 2 in the numerator is used to include the effect of the voltage drop across the output diode(s).

Thus for a 320V output, N should be 322/31.5 or 10.2. For a 300V output, choose N equal to 302/31.5 or 9.6.

The next parameter that needs to be set is the primary inductance,  $L_{PRI}$ . Choose  $L_{PRI}$  according to the following formula:

$$L_{PRI} \geq \frac{V_{OUT} \cdot 200 \cdot 10^{-9}}{N \cdot I_{PK}}$$

Where:  $V_{OUT}$  is the desired output voltage. N is the transformer turns ratio.  $I_{PK}$  is 1.4 (LT3484-0), 0.7 (LT3484-1), and 1.0 (LT3484-2).

$L_{PRI}$  needs to be equal or larger than this value to ensure that the LT3484-0/LT3484-1/LT3484-2 has adequate time to respond to the flyback waveform.

All other parameters need to meet or exceed the recommended limits as shown in Table 1. A particularly important parameter is the leakage inductance,  $L_{LEAK}$ . When the power switch of the LT3484-0/LT3484-1/LT3484-2 turns off, the leakage inductance on the primary of the transformer causes a voltage spike to occur on the SW pin. **The height of this spike must not exceed 40V**, even though the absolute maximum rating of the SW Pin is 50V. The 50V absolute maximum rating is a DC blocking voltage specification, which assumes that the current in the power NPN is zero. Figure 3 shows the SW voltage waveform for the circuit of Figure 6 (LT3484-0). Note that the absolute maximum rating of the SW pin is not exceeded. Make sure to check the SW voltage waveform with  $V_{OUT}$  near the target output voltage, as this is the worst case condition for SW voltage. Figure 4 shows the various limits on the SW voltage during switch turn off.

It is important not to minimize the leakage inductance to a very low level. Although this would result in a very low leakage spike on the SW pin, the parasitic capacitance of the transformer would become large. This will adversely affect the charge time of the photoflash circuit.

Linear Technology has worked with several leading magnetic component manufacturers to produce pre-designed flyback transformers for use with the LT3484-0/LT3484-1/LT3484-2. Table 2 shows the details of several of these transformers.

**Table 1. Recommended Transformer Parameters**

PARAMETER	NAME	TYPICAL RANGE LT3484-0	TYPICAL RANGE LT3484-1	TYPICAL RANGE LT3484-2	UNITS
$L_{PRI}$	Primary Inductance	>5	>10	>7	$\mu$ H
$L_{LEAK}$	Primary Leakage Inductance	100 to 300	200 to 500	200 to 500	nH
N	Secondary: Primary Turns Ratio	1:8 to 1:12	1:8 to 1:12	1:8 to 1:12	
$V_{ISO}$	Secondary to Primary Isolation Voltage	>500	>500	>500	V
$I_{SAT}$	Primary Saturation Current	>1.6	>0.8	>1.0	A
$R_{PRI}$	Primary Winding Resistance	<300	<500	<400	m $\Omega$
$R_{SEC}$	Secondary Winding Resistance	<40	<80	<60	$\Omega$



**APPLICATIONS INFORMATION**

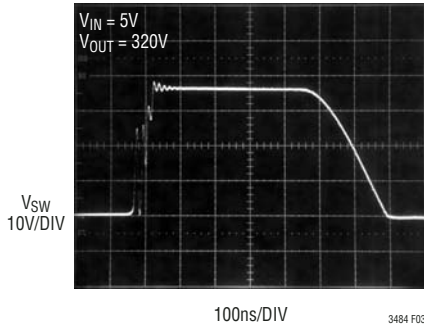


Figure 3. LT3484-0 SW Voltage Waveform

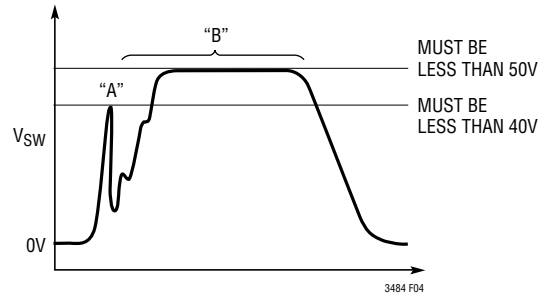


Figure 4. New Transformer Design Check (Not to Scale)

Table 2. Pre-Designed Transformers – Typical Specifications Unless Otherwise Noted

FOR USE WITH	TRANSFORMER NAME	SIZE (W × L × H) mm	LPRI (μH)	LPRI-LEAKAGE (nH)	N	RPRI (mΩ)	RSEC (Ω)	VENDOR
LT3484-0/LT3484-2 LT3484-1	SBL-5.6-1 SBL-5.6S-1	5.6 × 8.5 × 4.0 5.6 × 8.5 × 3.0	10 24	200 Max 400 Max	10.2 10.2	103 305	26 55	Kijima Musen Hong Kong Office 852-2489-8266 (ph) kijimahk@netvigator.com (email)
LT3484-0 LT3484-1 LT3484-2	LDT565630T-001 LDT565630T-002 LDT565630T-003	5.8 × 5.8 × 3.0 5.8 × 5.8 × 3.0 5.8 × 5.8 × 3.0	6 14.5 10.5	200 Max 500 Max 550 Max	10.4 10.2 10.2	100 Max 240 Max 210 Max	10 Max 16.5 Max 14 Max	TDK Chicago Sales Office (847) 803-6100 (ph) www.components.tdk.com
LT3484-0/LT3484-2 LT3484-1	T-15-089 T-15-083	6.4 × 7.7 × 4.0 8.0 × 8.9 × 2.0	12 20	400 Max 500 Max	10.2 10.2	211 Max 675 Max	27 Max 35 Max	Tokyo Coil Engineering Japan Office 0426-56-6262 (ph) www.tokyo-coil.co.jp

**Capacitor Selection**

For the input bypass capacitors, high quality X5R or X7R types should be used. Make sure the voltage capability of the part is adequate.

**Output Diode Selection**

The rectifying diode(s) should be low capacitance type with sufficient reverse voltage and forward current ratings. The peak reverse voltage that the diode(s) will see is approximately:

$$V_{PK-R} = V_{OUT} + (N \cdot V_{IN})$$

The peak current of the diode is simply:

$$I_{PK-SEC} = \frac{1.4}{N} \text{ (LT3484-0)}$$

$$I_{PK-SEC} = \frac{1.0}{N} \text{ (LT3484-2)}$$

$$I_{PK-SEC} = \frac{0.7}{N} \text{ (LT3484-1)}$$

For the circuit of Figure 6 with  $V_{BAT}$  of 5V,  $V_{PK-R}$  is 371V and  $I_{PK-SEC}$  is 137mA. The GSD2004S dual silicon diode is recommended for most LT3484-0/LT3484-1/LT3484-2 applications. Another option is to use the BAV23S dual silicon diodes. Table 3 shows the various diodes and relevant specifications. Use the appropriate number of diodes to achieve the necessary reverse breakdown voltage.

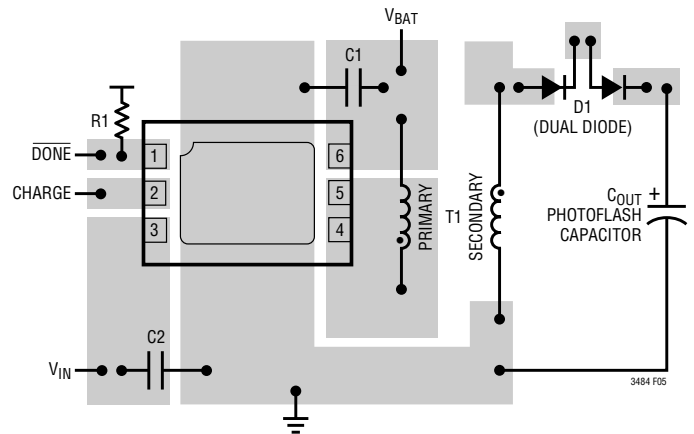
## APPLICATIONS INFORMATION

**Table 3. Recommended Output Diodes**

PART	MAX REVERSE VOLTAGE (V)	MAX FORWARD CONTINUOUS CURRENT (mA)	CAPACITANCE (pF)	VENDOR
GSD2004S (Dual Diode)	2x300	225	5	Vishay (402) 563-6866 www.vishay.com
BAV23S (Dual Diode)	2x250	225	5	Philips Semiconductor (800) 447-1500 www.philips.com
MMBD3004S (Dual Diode)	2x350	225	5	Diodes Inc (816) 251-8800 www.diodes.com

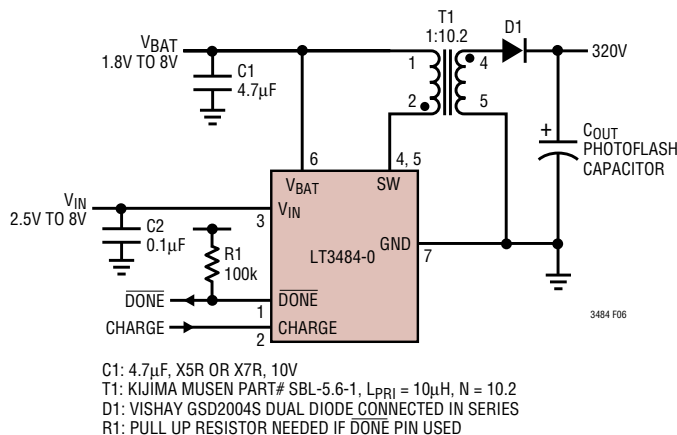
### Board Layout

The high voltage operation of the LT3484-0/LT3484-1/LT3484-2 demands careful attention to board layout. You will not get advertised performance with careless layout. Figure 5 shows the recommended component placement. Keep the area for the high voltage end of the secondary as small as possible. Also note the larger than minimum spacing for all high voltage nodes in order to meet breakdown voltage requirements for the circuit board. *It is imperative to keep the electrical path formed by C1, the primary of T1, and the LT3484-0/LT3484-1/LT3484-2 as short as possible.* If this path is haphazardly made long, it will effectively increase the leakage inductance of T1, which may result in an overvoltage condition on the SW pin.

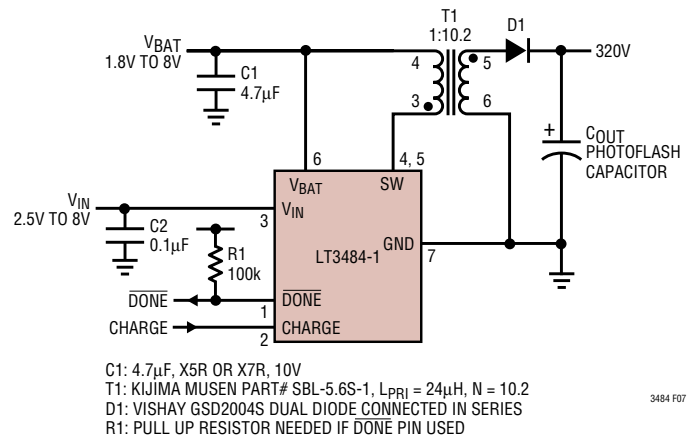


**Figure 5. Suggested Layout: Keep Electrical Path Formed by C1, Transformer Primary and LT3484-0/LT3484-1/LT3484-2 Short**

## TYPICAL APPLICATIONS



**Figure 6. LT3484-0 Photoflash Charger Uses High Efficiency 4mm Tall Transformer**



**Figure 7. LT3484-1 Photoflash Charger Uses High Efficiency 3mm Tall Transformer**

TYPICAL APPLICATIONS

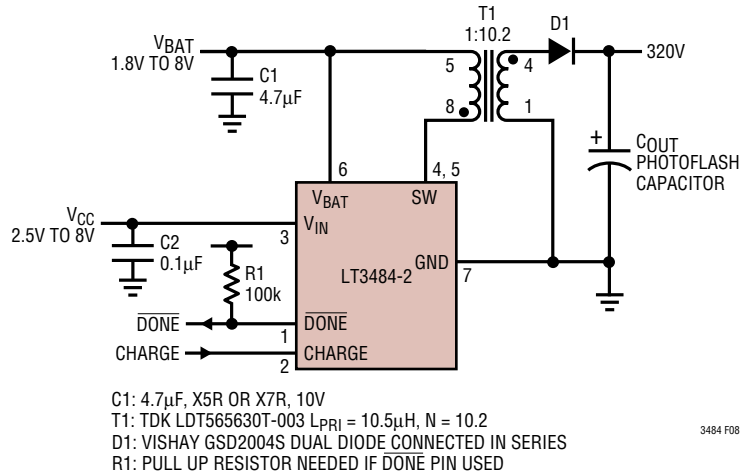
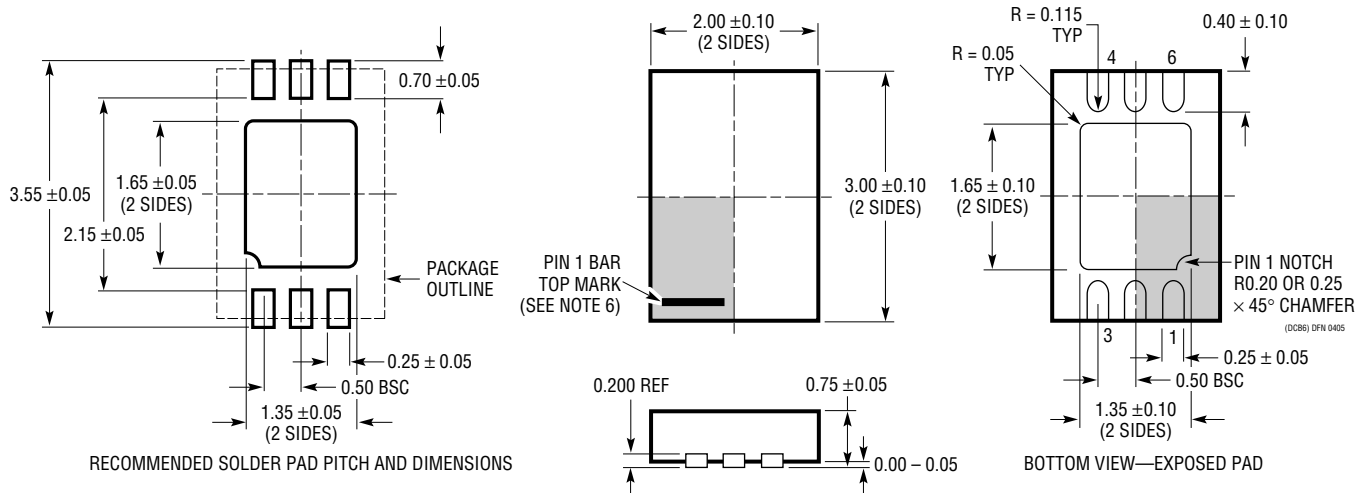


Figure 8. LT3484-2 Photoflash Charger Uses High Efficiency 3mm Tall Transformer

PACKAGE DESCRIPTION

DCB Package  
 6-Lead Plastic DFN (2mm × 3mm)  
 (Reference LTC DWG # 05-08-1715)



- NOTE:
- DRAWING TO BE MADE A JEDEC PACKAGE OUTLINE MO-229 VARIATION OF (TBD)
  - DRAWING NOT TO SCALE
  - ALL DIMENSIONS ARE IN MILLIMETERS
  - DIMENSIONS OF EXPOSED PAD ON BOTTOM OF PACKAGE DO NOT INCLUDE MOLD FLASH. MOLD FLASH, IF PRESENT, SHALL NOT EXCEED 0.15mm ON ANY SIDE
  - EXPOSED PAD SHALL BE SOLDER PLATED
  - SHADED AREA IS ONLY A REFERENCE FOR PIN 1 LOCATION ON THE TOP AND BOTTOM OF PACKAGE