

FEATURES

- Three 100mA Buck Regulators, Each Drives Up to 10 LEDs with Fast NPN Current Sources
- Fast Current Sources for $<1\mu\text{s}$ Pulse Widths (10,000:1 True Color PWM™ Dimming at 100Hz)
- LEDs Disconnected in Shutdown
- Adaptive V_{OUT} for Increased Efficiency
- 6V to 60V Input Voltage Range
- $\pm 2\%$ LED Current Matching
- External Resistor Sets LED Current for Each Channel
- Internal Compensation and Soft-Start
- Programmable Switching Frequency (200kHz to 1MHz)
- Synchronizable to External Clock
- Open LED Detection and Reporting
- Shorted LED Pin Protection and Reporting
- Programmable LED Thermal Derating
- Programmable Temperature Protection
- 5mm \times 8mm Thermally Enhanced QFN Package with a 0.6mm High Voltage Pin Spacing

APPLICATIONS

- LED Billboards and Signboards
- Mono, Multi, Full-Color LED Displays
- Large Screen Display LED Backlighting
- Automotive, Industrial, and Medical Displays

DESCRIPTION

The LT®3597 is a 60V triple step-down LED driver capable of achieving 10,000:1 digital PWM dimming at 100Hz with fast NPN current sources driving up to 10 LEDs in each channel. LED dimming can also be achieved via analog control of the CTRL1-3 pin.

The step-down switching frequency is programmed between 200kHz and 1MHz. The frequency is also synchronizable to an external clock. The LT3597 provides maximum LED brightness while adhering to manufacturers' specifications for thermal derating. The derate temperature is programmed by placing a negative temperature coefficient (NTC) resistor on the master control pin.

The LT3597 adaptively controls V_{OUT} in order to achieve optimal efficiency. Other features include: 2% LED current matching between channels, open LED reporting, shorted LED protection, programmable LED current, and programmable temperature protection.

LT, LT, LTC and LTM are registered trademarks of Linear Technology Corporation. True Color PWM is a trademark of Linear Technology Corporation. All other trademarks are the property of their respective owners.

TYPICAL APPLICATION

Triple Step-Down RGB Single Pixel LED Driver, 100mA Current

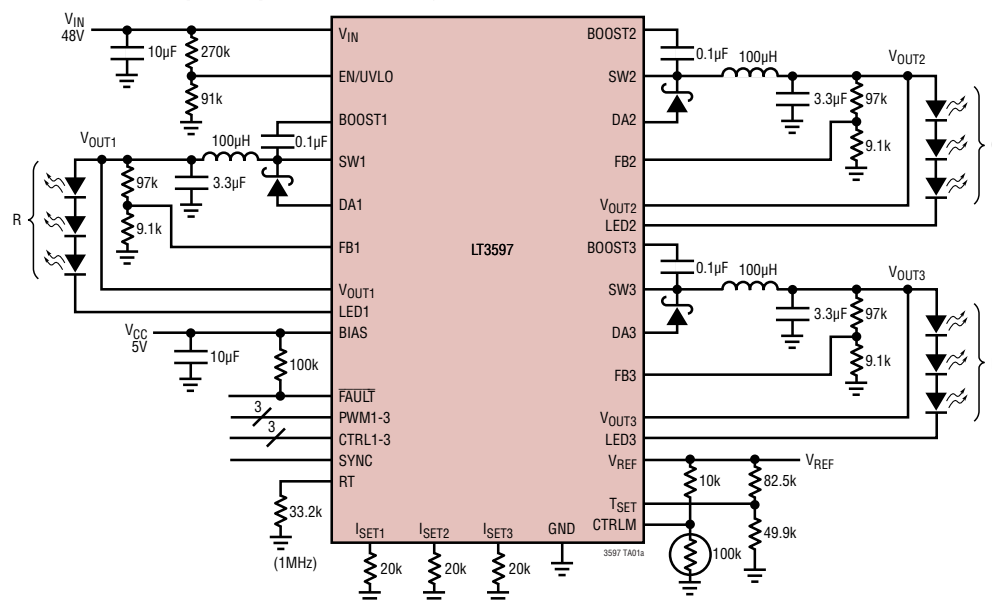

10,000:1 PWM Dimming at 100Hz

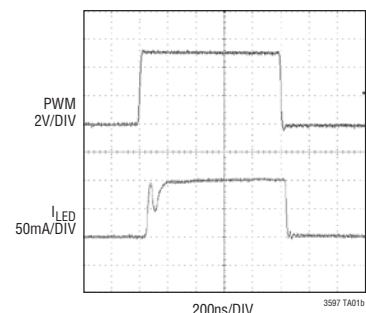

ABSOLUTE MAXIMUM RATINGS

(Note 1)

Input Voltage (V_{IN}), EN/UVLO	60V
BOOST1-3	85V
BOOST Pin Above SW Pin	25V
LED1-3, V_{OUT1-3}	42V
BIAS, \overline{FAULT}	25V
V_{REF} , RT, I_{SET1-3} , T_{SET} , CTRLM	3V
FB1-3, CTRL1-3, PWM1-3, SYNC	6V
Operating Junction Temperature Range (Notes 2, 3)	-40°C to 125°C
Maximum Junction Temperature	125°C
Storage Temperature Range	-65°C to 150°C

PIN CONFIGURATION

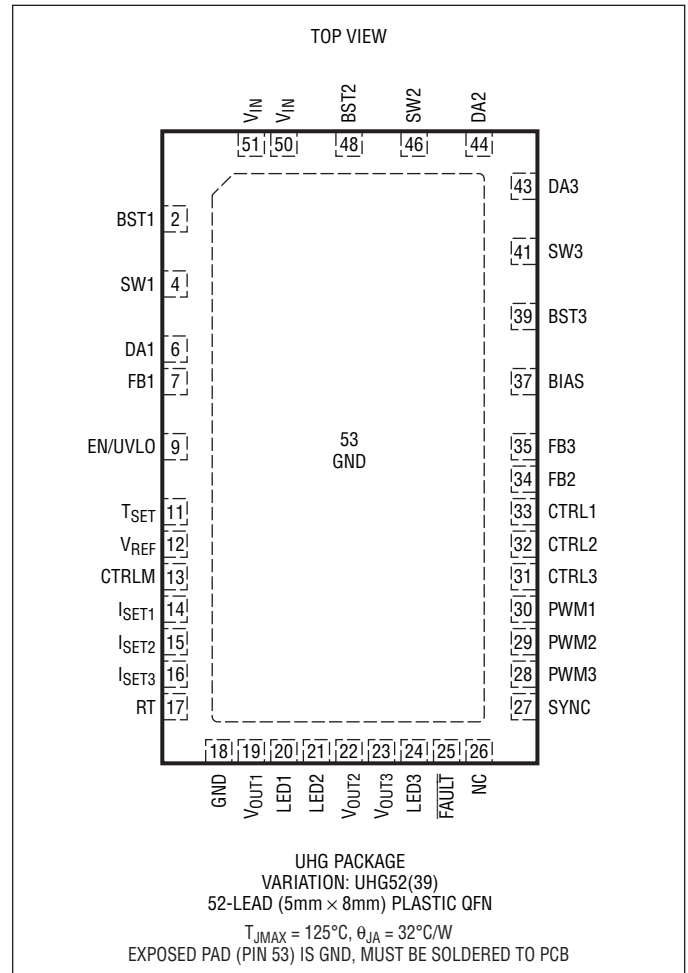

ORDER INFORMATION

LEAD FREE FINISH	TAPE AND REEL	PART MARKING*	PACKAGE DESCRIPTION	TEMPERATURE RANGE
LT3597EUHG#PBF	LT3597EUHG#TRPBF	3597	52-Lead (5mm × 8mm) Plastic QFN	-40°C to 125°C
LT3597IUHG#PBF	LT3597IUHG#TRPBF	3597	52-Lead (5mm × 8mm) Plastic QFN	-40°C to 125°C

Consult LTC Marketing for parts specified with wider operating temperature ranges. *The temperature grade is identified by a label on the shipping container. Consult LTC Marketing for information on non-standard lead based finish parts.

For more information on lead free part marking, go to: <http://www.linear.com/leadfree/>

For more information on tape and reel specifications, go to: <http://www.linear.com/tapeandreeel/>

ELECTRICAL CHARACTERISTICS The ● denotes the specifications which apply over the full operating temperature range, otherwise specifications are at $T_A = 25^\circ\text{C}$. $V_{IN} = 24\text{V}$, $\text{BOOST} = 29\text{V}$, $\text{BIAS} = 5\text{V}$, $\text{EN/UVLO} = 5\text{V}$, $\text{PWM1-3} = 3.3\text{V}$, $\text{CTRL1-3} = \text{CTRLM} = T_{\text{SET}} = 2.0\text{V}$, $V_{\text{OUT1-3}} = 24\text{V}$, $\text{SYNC} = 0\text{V}$, unless otherwise specified. (Note 2)

PARAMETER	CONDITIONS	MIN	TYP	MAX	UNITS
V_{IN} Operating Voltage		● 6		55	V
Quiescent Current from V_{IN}	EN/UVLO = 0.4V BIAS = 5V, Not Switching BIAS = 0V, Not Switching			2 2.1 4	μA mA mA
Minimum BIAS Voltage			3	3.1	V
Quiescent Current from BIAS	EN/UVLO = 0.4V BIAS = 5V, Not Switching BIAS = 0V, Not Switching, Current Out of Pin			2 2 60	μA mA μA
EN Threshold (Falling)		0.4	0.7		V
UVLO Threshold (Falling)		1.47	1.51	1.53	V
EN/UVLO Pin Current (Hysteresis)	EN/UVLO = 1.6V EN/UVLO = 1.4V	4	10 5.1	6	nA μA
FB1-3 Regulation Voltage		1.15	1.22	1.25	V
FB1-3 Pin Bias Current	FB = 6V			200	nA
Maximum Duty Cycle	$R_T = 220\text{k}$ (200kHz) $R_T = 33.2\text{k}$ (1MHz)	90 78	95 85		% %
Switch Saturation Voltage	$I_{\text{SW1-3}} = 100\text{mA}$		265		mV
Switch Current Limit		400	510	700	mA
DA Pin Current to Stop OSC		225	280	350	mA
Switch Leakage	$V_{\text{SW1-3}} = 0\text{V}$			700	nA
BST1-3 Pin Current	$I_{\text{SW1-3}} = 100\text{mA}$		2		mA
Switching Frequency	$R_T = 220\text{k}$ $R_T = 33.2\text{k}$	170 900	200 1000	230 1100	kHz kHz
SYNC Input Low				0.4	V
SYNC Input High		1.6			V
SYNC Frequency Range	$R_T = 220\text{k}$ $R_T = 47\text{k}$	240		1000	kHz kHz
SYNC Pin Bias Current	$V_{\text{SYNC}} = 3.3\text{V}$			200	nA
Soft-Start Time	(Note 4)		2.5		ms
V_{REF} Voltage	$I_{\text{VREF}} = 0\mu\text{A}$	● 1.96	2.0	2.04	V
Maximum V_{REF} Current		200			μA
$I_{\text{SET1-3}}$ Pin Voltage	$R_{\text{ISET1-3}} = 20\text{k}$, $V_{\text{CTRL}} = V_{\text{CTRLM}} = T_{\text{SET}} = 1.5\text{V}$		1.0		V
T_{SET} Voltage for LED Current Derating			540		mV
T_{SET} Pin Leakage Current	$V_{T\text{SET}} = 1.0\text{V}$			200	nA
$I_{\text{LED1-3}}$ LED Current	$R_{\text{ISET1-3}} = 20\text{k}$	● 98 97	100 100	102 103	mA mA

ELECTRICAL CHARACTERISTICS

The ● denotes the specifications which apply over the full operating temperature range, otherwise specifications are at $T_A = 25^\circ\text{C}$. $V_{IN} = 24\text{V}$, $\text{BOOST} = 29\text{V}$, $\text{BIAS} = 5\text{V}$, $\text{EN/UVLO} = 5\text{V}$, $\text{PWM1-3} = 3.3\text{V}$, $\text{CTRL1-3} = \text{CTRLM} = T_{\text{SET}} = 2.0\text{V}$, $V_{\text{OUT1-3}} = 24\text{V}$, $\text{SYNC} = 0\text{V}$, unless otherwise specified. (Note 2)

PARAMETER	CONDITIONS	MIN	TYP	MAX	UNITS
LED String Current Matching	$R_{\text{ISET1-3}} = 20\text{k}$		±0.35 ±0.35	±1.5 ±2	% %
LED Pin Voltage	Adaptive V_{OUT} Loop Enabled		1.1		V
LED1-3 Open Detection Threshold			0.28		V
LED1-3 Short Protection Threshold (from GND)	$\text{PWM1-3} = 3.3\text{V}$	10		15	V
LED1-3 Short Protection Threshold (from $V_{\text{OUT1-3}}$)	$V_{\text{OUT1-3}} = 6\text{V}$	1	1.25	2	V
LED1-3 Pin Leakage Current	$V_{\text{LED1-3}} = 42\text{V}$			200	nA
PWM1-3 Input Low Voltage				0.4	V
PWM1-3 Input High Voltage		1.6			V
PWM1-3 Pin Bias Current				200	nA
CTRL1-3 Voltage for Full LED Current		1.2			V
CTRL1-3 Pin Bias Current	$\text{CTRL1-3} = 6\text{V}$			200	nA
CTRLM Voltage for Full LED Current		1.2			V
CTRLM Pin Bias Current	$\text{CTRLM} = 3\text{V}$			200	nA
$\overline{\text{FAULT}}$ Output Voltage Low	$I_{\text{FAULT}} = 200\mu\text{A}$		0.11		V
$\overline{\text{FAULT}}$ Pin Input leakage Current	$\overline{\text{FAULT}} = 25\text{V}$			200	nA

Note 1: Stresses beyond those listed under Absolute Maximum Ratings may cause permanent damage to the device. Exposure to any Absolute Maximum Rating condition for extended periods may affect device reliability and lifetime.

Note 2: The LT3597E is guaranteed to meet performance specifications from 0°C to 125°C junction temperature. Specifications over the -40°C to 125°C operating junction temperature range are assured by design, characterization and correlation with statistical process controls. The LT3597I specifications are guaranteed over the full -40°C to 125°C operating junction temperature range.

Note 3: For Maximum Operating Ambient Temperature, see Thermal Considerations in the Applications Information section.

Note 4: Guaranteed by design.

TYPICAL PERFORMANCE CHARACTERISTICS $T_A = 25^\circ\text{C}$, unless otherwise noted.

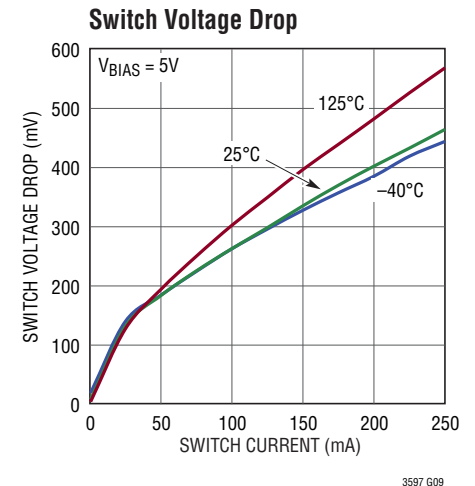
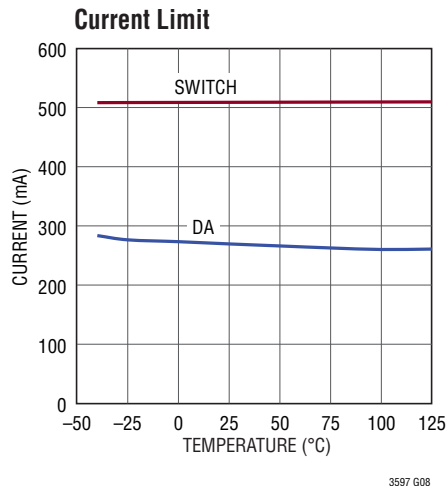
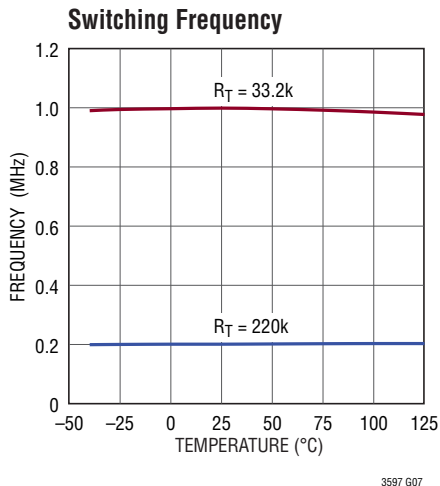
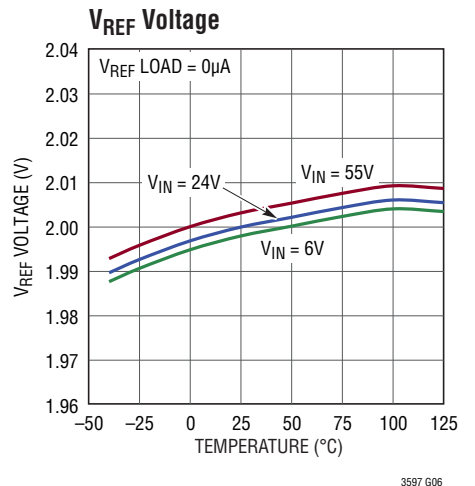
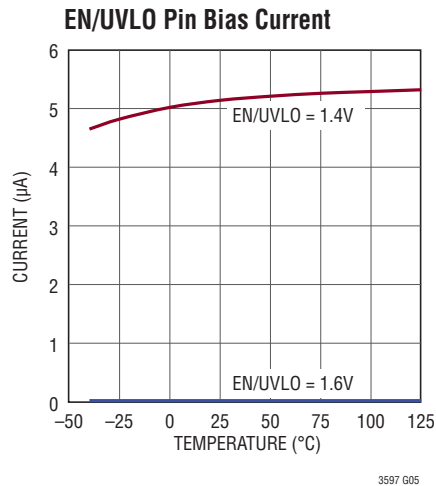
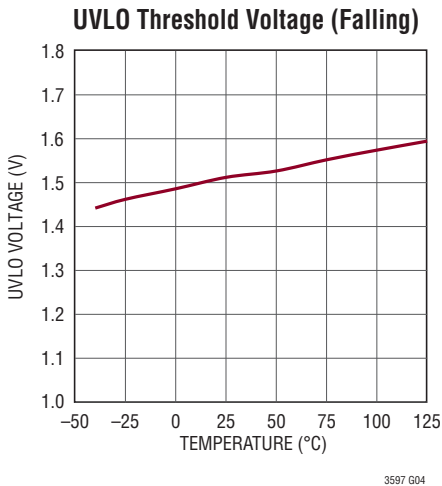
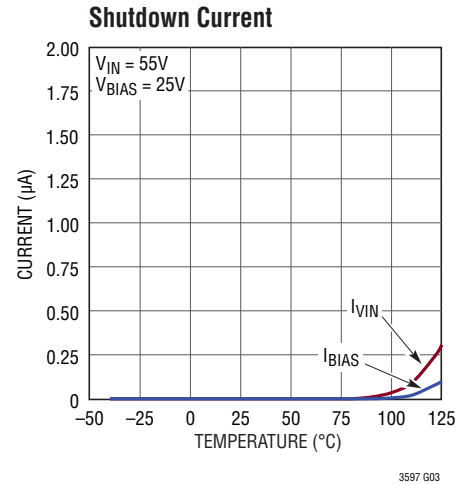
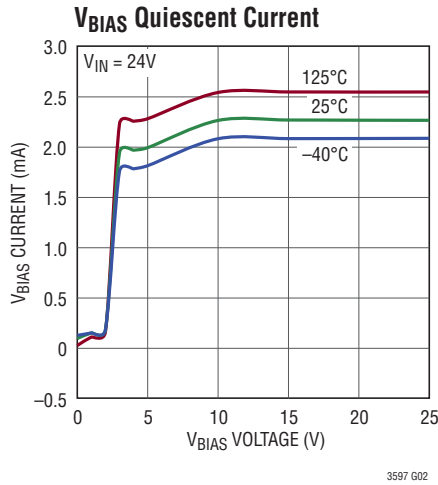
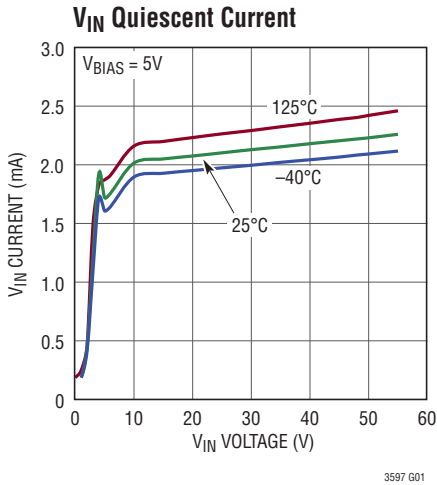

TYPICAL PERFORMANCE CHARACTERISTICS $T_A = 25^\circ\text{C}$, unless otherwise noted.

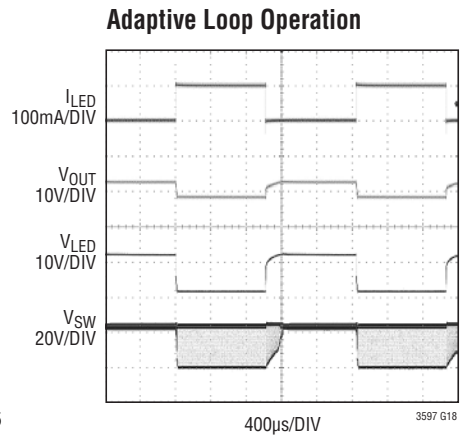
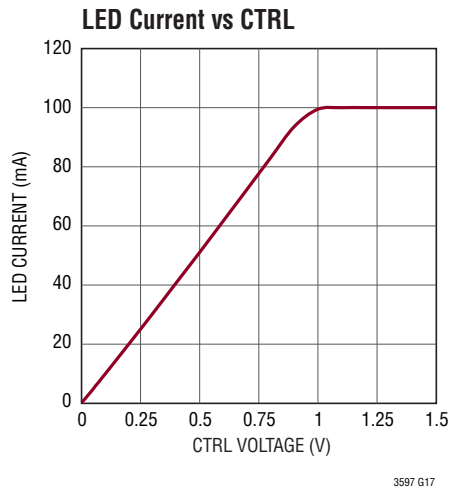
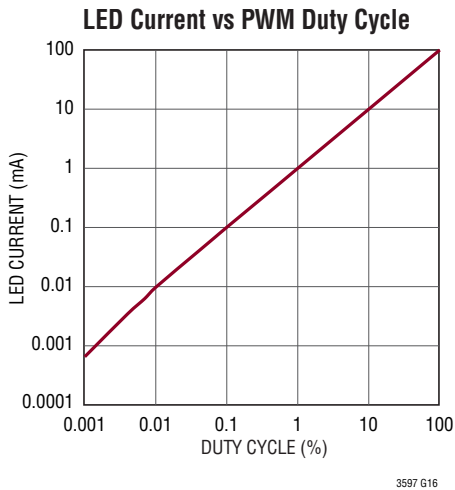
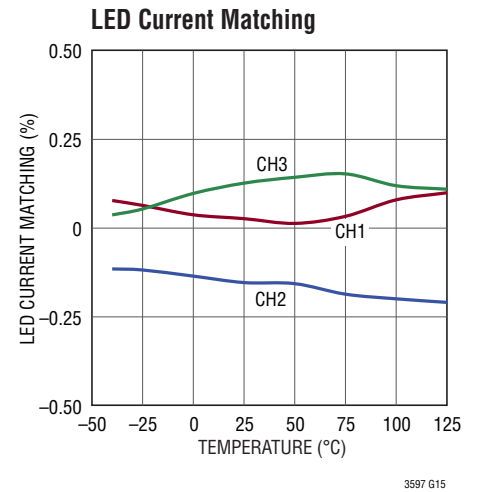
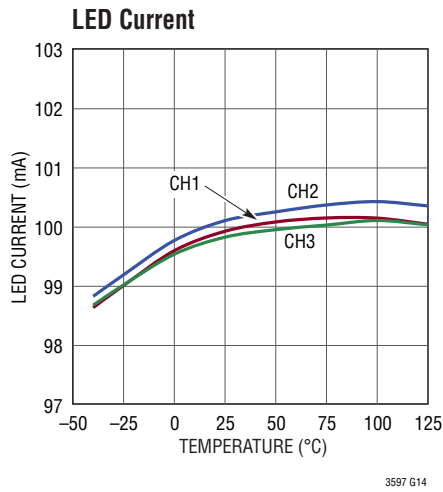
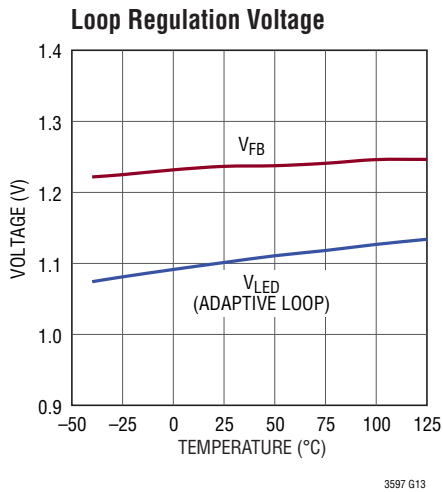
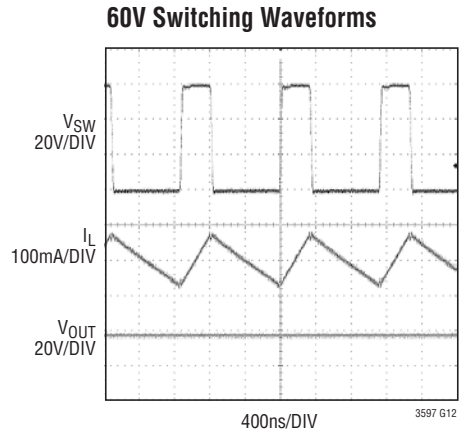
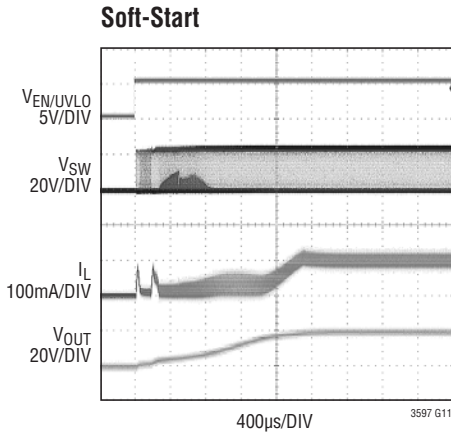
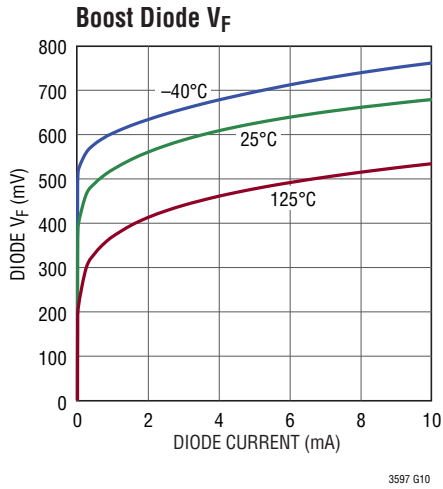

TYPICAL PERFORMANCE CHARACTERISTICS $T_A = 25^\circ\text{C}$, unless otherwise noted.

20,000:1 PWM Dimming (100Hz)

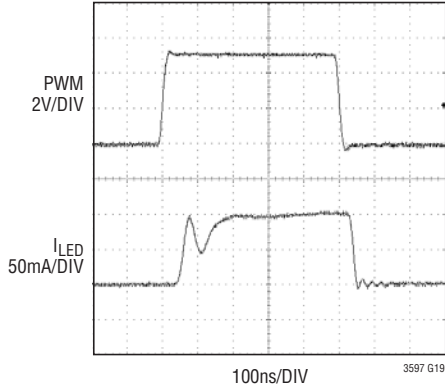

1,000:1 PWM Dimming (100Hz)

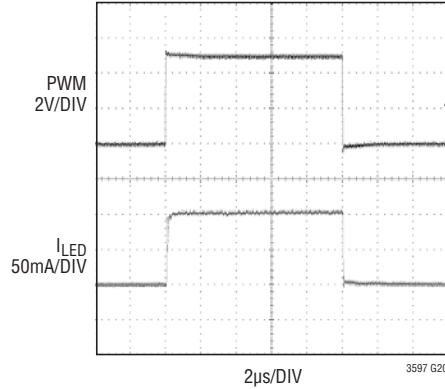

Open LED Fault

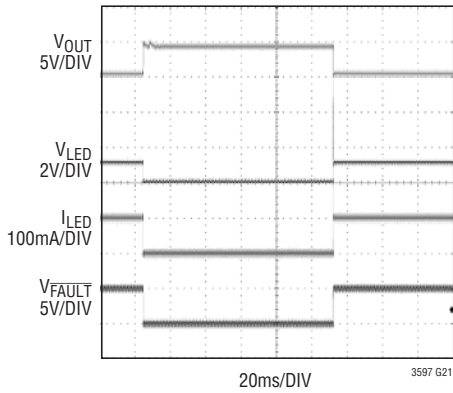

Shorted LEDs Fault

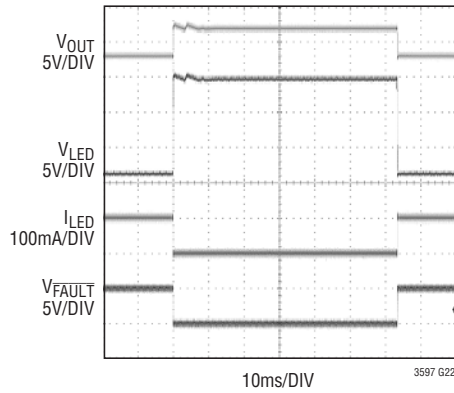

FAULT Pin Voltage Low

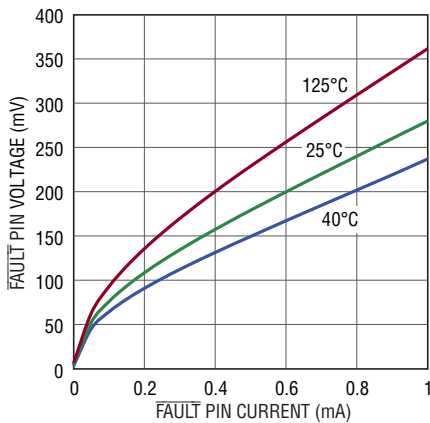

T_{SET} Voltage for Temperature Derating

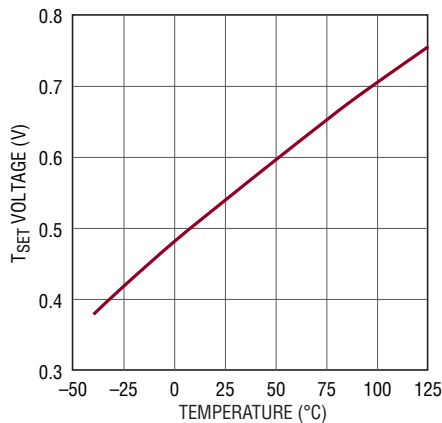

T_{SET} LED Current Derating

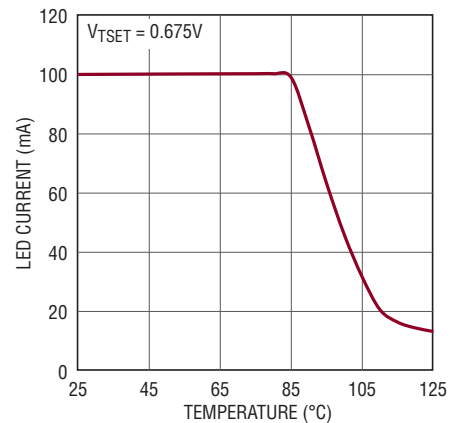

PIN FUNCTIONS

BOOST1, BOOST2, BOOST3 (Pins 2, 48, 39): Boost Capacitor Pin. This pin is used to provide a voltage that is higher than the input voltage when the switch is on to supply current to the switch driver.

SW1, SW2, SW3 (Pins 4, 46, 41): Switch Pin. Connect the inductor, catch diode and boost capacitor to this pin.

DA1, DA2, DA3 (Pins 6, 44, 43): Catch Diode Anode. This pin is used to provide frequency foldback in extreme situations.

FB1, FB2, FB3 (Pins 7, 34, 35): Feedback Pin. This pin is regulated to the internal bandgap voltage. The maximum Buck output voltage can be set by connecting this pin to a resistor divider from VOUT1-3.

EN/UVLO (Pin 9): Enable and Undervoltage Lockout Pin. Accurate 1.51V threshold. UVLO threshold can be programmed by using a resistor divider from V_{IN} . If function is not required, pin can be tied to the VIN pin.

TSET (Pin 11): Thermal Regulation Pin. Programs the LT3597 junction temperature at which LED current begins to derate.

VREF (Pin 12): 2.0V Reference Output Pin. This pin can source up to 200 μ A and can be used to program TSET and CTRLM.

CTRLM (Pin 13): Master Control Pin. LED current derating vs temperature is achievable for all channels if the voltage on CTRLM has a negative temperature coefficient using an external NTC resistor in a voltage divider from VREF.

ISET1, ISET2, ISET3 (Pins 14, 15, 16): LED Current Programming Pin. A resistor to ground programs full-scale LED current.

RT (Pin 17): Switching Frequency Programming Pin. A resistor to ground programs the switching frequency between 200kHz and 1MHz.

GND (Pin 18, Exposed Pad Pin 53): Ground Pin. This is the ground for both the IC and the switching converters. Exposed pad must be soldered to PCB ground.

VOUT1, VOUT2, VOUT3 (Pins 19, 22, 23): Buck Output. This is the buck regulator output voltage sense into the IC.

LED1, LED2, LED3 (Pins 20, 21, 24): Constant Current Sink Pin. These are 3 LED driver outputs, each containing an open collector, constant current sink. All outputs are matched within $\pm 2\%$ and are individually programmed up to 100mA using an external resistor at the ISET1-3 pin. Outputs are rated to allow a maximum VOUT1-3 of 42V. Connect the cathode of the LED string to LED1-3. Connect the anode of the LED string to VOUT1-3.

FAULT (Pin 25): Fault Detection Pin. Open collector pin used to report open LED faults. $\overline{\text{FAULT}}$ must be externally pulled to a positive supply through a resistor.

NC (Pin 26): No Connection Pin. Tie to ground.

SYNC (Pin 27): External Clock Synchronization Pin. When an external clock drives this pin, the Buck regulators are synchronized to that frequency. Frequency programmed by the RT pin resistor must be at least 20% less than the SYNC pin clock frequency.

PWM1, PWM2, PWM3 (Pins 30, 29, 28): PWM Dimming Control Pin. When driven to a logic high, the LED1-3 current sink is enabled. If PWM dimming is not desired, connect the pin to VREF. Channels can be individually disabled by tying PWM1-3 to ground.

CTRL1, CTRL2, CTRL3 (Pins 33, 32, 31): Analog Dimming Control Pin. This pin is used to dim the LED current in an analog fashion. If the pin is tied to a voltage lower than 1.0V, it will linearly reduce the LED current. If feature is unused, connect the pin to VREF.

BIAS (Pin 37): Supply Pin. This pin is the supply for an internal voltage regulator to internal analog and digital circuitry. BIAS must be locally bypassed with a 2.2 μ F capacitor.

VIN (Pins 50, 51): Input Supply Pin. V_{IN} must be locally bypassed with a 10 μ F capacitor to ground. Pins 50 and 51 are internally fused.

BLOCK DIAGRAM

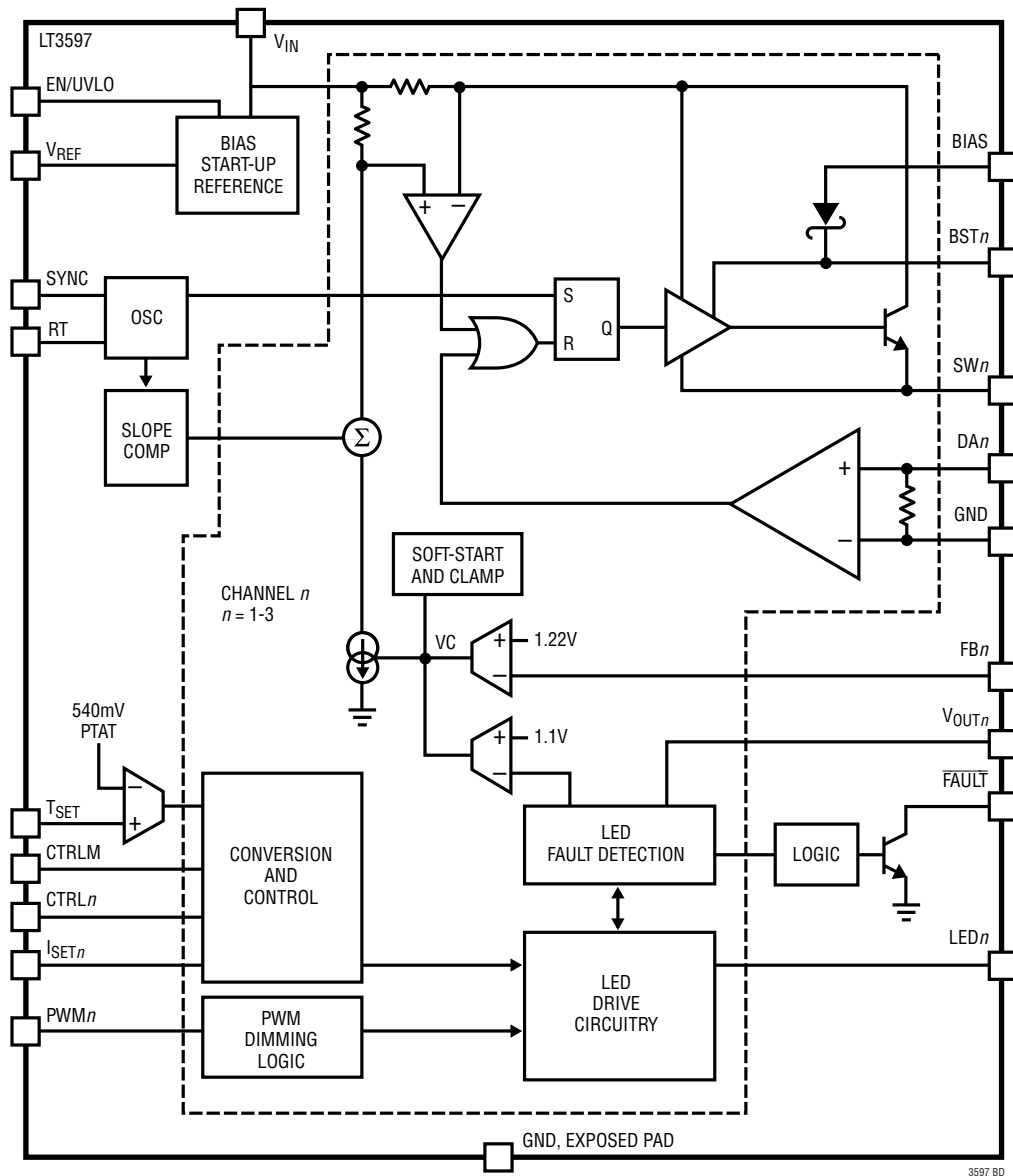

Figure 1. Block Diagram

OPERATION

The LT3597 uses a constant frequency, internally compensated peak current mode control scheme. Operation is best understood by referring to the Block Diagram in Figure 1.

Enable and undervoltage lockout (UVLO) are both controlled by a single pin. If the pin falls below 1.51V, an accurate comparator turns off the LED drivers and buck regulators. If the pin continues to fall to less than 0.4V, the part enters shutdown and consumes less than 2 μ A.

The LT3597 contains three constant current sink LED drivers. Each of the three LED strings is powered from a dedicated adaptive buck converter in order to achieve maximum efficiency. The frequency of the buck regulators is programmed from 200kHz to 1MHz using an external resistor. The frequency can also be synchronized to an external clock using the SYNC pin.

Internal buck compensation and soft-start requires few external components and permits simple board layout. A high-side switch current limit protects the internal switch during its on time, while a low side current limit prevents the switch from turning on in the case of excessive off phase current.

Step-Down Adaptive Control

Adaptive control of the output voltages achieves superior system efficiency. When a given channel's PWM pin is low, the respective buck regulator output will go to a programmable high output voltage. In this case the buck will enter into a pulse-skipping mode since there is no load connected. This guarantees that the buck output voltage is high enough to immediately supply the LED current once the string is reactivated. As soon as PWM goes high, the output voltage of the buck will drop until there

is 1V across the LED current sink. This scheme ensures the best efficiency for each LED channel. Since each LED string is independently driven from a separate buck channel, efficiency is optimized for all three strings even if the number of LEDs is mismatched between the channels.

Another benefit of this regulation method is that the LT3597 starts up with 10,000:1 dimming even if the PWM1-3 pulse width is 1 μ s. Since V_{OUT} starts up even if PWM1-3 is low, the part achieves high dimming ratios with narrow pulse widths within a couple of PWM1-3 clock cycles.

LED Current

Each LED string current can be individually programmed up to a maximum of 100mA with a 2% matching accuracy between the strings. An external resistor on the I_{SET1-3} pin programs the max current for that string. The CTRL1-3 pin can be used for analog dimming. Digital PWM can be programmed using the PWM1-3 pin. A dimming ratio of 10,000:1 can be achieved at a frequency of 100Hz.

Fault Protection and Reporting

The LT3597 protects against both open LED and shorted LED conditions. If the LED1-3 pin voltage exceeds 12V while the LED string is sinking current, or if the LED1-3 pin voltage is within 1.25V of V_{OUT1-3} pin voltage, the channel is disabled until the fault is removed. If the LED string opens, the LT3597 will limit the output to the voltage set by the FB resistor divider.

The LT3597 reports a fault on the \overline{FAULT} pin if any of the LED strings is open or shorted. LED faults are only reported if the respective string PWM signal is high. A fault is also reported if the internal die temperature reaches the T_{SET} programmed derating limit.

APPLICATIONS INFORMATION

Inductor Selection

Inductor values between 100µH and 470µH are recommended for most applications. It is important to choose an inductor that can handle the peak current without saturating. The inductor DCR (copper wire resistance) must also be low in order to minimize I^2R power losses. Table 1 lists several recommended inductors.

Table 1. Recommended Inductors

PART	L (µH)	DCR (Ω)	CURRENT RATING (A)	VENDOR
LPS6225	100	0.61	0.52	Coilcraft www.coilcraft.com
MSS1038	100	0.3	1.46	
MSS1038	220	0.76	0.99	
MSS1038	470	1.24	0.70	
CDRH105R	100	0.253	1.35	Sumida www.sumida.com
CDRW105R	220	0.50	0.94	
CDRH105R	470	1.29	0.60	
CDR6D28MN	100	0.9	0.75	
DS1262C2	100	0.17	1.5	Toko www.toko.com
DS1262C2	220	0.35	1.0	
DS1262C2	470	1.243	0.7	
SLF10145T	100	0.26	1.0	TDK www.tdk.com
SLF10145T	220	0.47	0.7	
DR73	100	0.527	0.79	Coiltronics www.cooperet.com
DR73	220	1.05	0.53	

Capacitor Selection

Low ESR (equivalent series resistance) capacitors should be used at the outputs to minimize output ripple voltage. Use only X5R or X7R dielectrics, as these materials retain their capacitance over wider voltage and temperature ranges than other dielectrics. Table 2 lists some suggested manufacturers. Consult the manufacturers for detailed information on their entire selection of ceramic surface mount parts.

Table 2. Recommended Ceramic Capacitor Manufacturers

Taiyo Yuden	www.t-yuden.com
AVX	www.avxcorp.com
Murata	www.murata.com
Kemet	www.kemet.com
TDK	www.tdk.com

Typically 10µF capacitors are sufficient for the V_{IN} and BIAS pins. The output capacitor for the buck regulators depends on the number of LEDs and switching frequency. Refer to Table 3 for the proper output capacitor selection.

Table 3. Recommended Output Capacitor Values ($V_{LED} = 3.5V$)

SWITCHING FREQUENCY (kHz)	# LEDs	C_{OUT} (µF)
1000	1-3	3.3
	>3	2.2
500	1-3	4.7
	>3	3.3
200	1-3	15
	>3	6.8

Diode Selection

Schottky diodes, with their low forward voltage drop and fast switching speed, must be used for all LT3597 applications. Do not use P-N junction diodes. The diode's average current rating must exceed the application's average current. The diode's maximum reverse voltage must exceed the application's input voltage. Table 4 lists some recommended Schottky diodes.

Table 4. Recommended Diodes

PART	MAX CURRENT (A)	MAX REVERSE VOLTAGE (V)	MANUFACTURER
DFLS160	1	60	Diodes, Inc. www.diodes.com
B160	1	60	
CMMSH1-60	1	60	Central www.centralsemi.com
ESIPB	1	100	Vishay www.vishay.com

APPLICATIONS INFORMATION

Undervoltage Lockout (UVLO)

The EN/UVLO can be used to program the input UVLO threshold by connecting it to a resistor divider from the V_{IN} pin as shown in Figure 2.

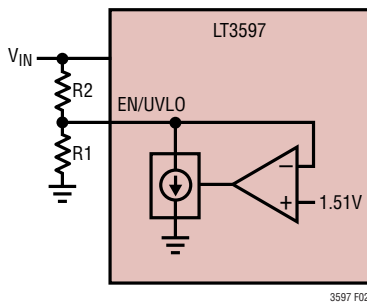

Figure 2. EN/UVLO Control

Select R1 and R2 according to the following equation:

$$V_{IN(UVLO)} = 1.51V \cdot \left(1 + \frac{R2}{R1} \right)$$

In UVLO an internal 5.1µA pull-down current source is connected to the pin for programmable UVLO hysteresis. The hysteresis can be set according to the following equation:

$$V_{UVLO(HYST)} = 5.1\mu A \cdot R2$$

Care must be taken if too much hysteresis is programmed, the pin voltage might drop too far and cause the current source to saturate.

Once the EN/UVLO pin falls below 0.4V, the part enters into shutdown.

Programming Maximum LED Current

Maximum LED current can be programmed by placing a resistor ($R_{ISET1-3}$) between the ISET1-3 pin and ground. $R_{ISET1-3}$ values between 20k and 100k can be chosen to set the maximum LED current between 100mA and 20mA respectively.

The LED current is programmed according to the following equation:

$$I_{LED1-3} = 2 \cdot \frac{1V}{R_{ISET1-3}} \text{ (mA)}$$

See Table 5 and Figure 3 for resistor values and corresponding programmed LED current.

Table 5. LED Current Programming

$R_{ISET1-3}$ VALUE (kΩ)	LED CURRENT (mA)
20	100
25	80
33.3	60
50	40
100	20

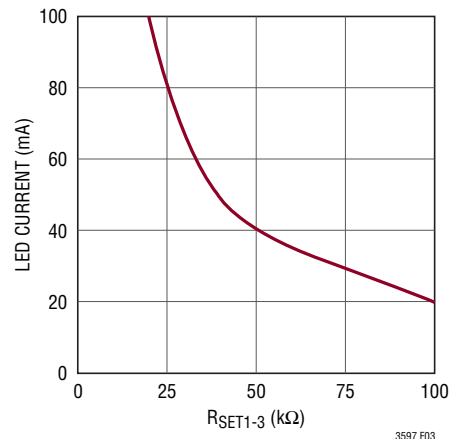

Figure 3. $R_{ISET1-3}$ Value for LED Current

APPLICATIONS INFORMATION

LED Current Dimming

Two different types of dimming control are available with the LT3597. The LED current can be dimmed using the CTRL1-3 pin or the PWM1-3 pin.

For some applications, a variable DC voltage that adjusts the LED current is the preferred method for brightness control. In that case, the CTRL1-3 pin can be modulated to set the LED dimming (see Figure 4). As the CTRL1-3 pin voltage rises from 0V to 1.0V, the LED current increases from 0mA to the maximum programmed LED current in a linear fashion. As the CTRL1-3 pin continues to increase past 1.0V, the maximum programmed LED current is maintained. If this type of dimming control is not desired, the CTRL1-3 pin can be tied to V_{REF} .

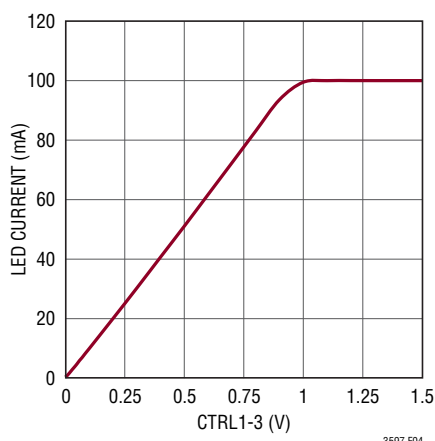

Figure 4. LED Current vs CTRL1-3 Voltage

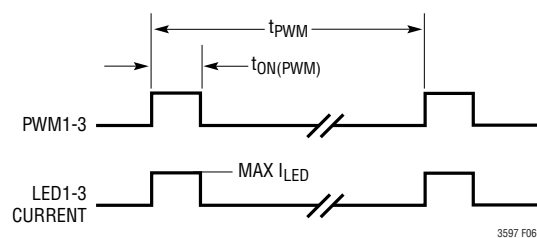

Figure 5. LED Current Using PWM Dimming

For True Color PWM dimming, the LT3597 provides up to 10,000:1 PWM dimming range at 100Hz. This is achieved by allowing the duty cycle of the PWM1-3 pin to be reduced from 100% to 0.01% for a PWM frequency of 100Hz (see Figure 5), hence a minimum on-time of 1 μ s and a maximum period of 100ms. PWM duty cycle dimming allows for constant LED color to be maintained over the entire dimming range.

Using the T_{SET} Pin for Thermal Protection

The LT3597 contains a special programmable thermal regulation loop that limits the internal junction temperature. This thermal regulation feature provides important protection at high ambient temperatures, and allows a given application to be optimized for typical, not worst-case, ambient temperatures with the assurance that the LT3597 will automatically protect itself and the LED strings under worst-case conditions.

As the ambient temperature increases, so does the internal junction temperature of the part. Once the programmed maximum junction temperature is reached, the LT3597 linearly reduces the LED current, as needed, to maintain this junction temperature. This can only be achieved when the ambient temperature stays below the maximum programmed junction temperature. If the ambient temperature continues to rise above the programmed maximum junction temperature, the LED current will reduce to less than 20% of the full current.

A resistor divider from the V_{REF} pin programs the maximum part junction temperature as shown in Figure 6.

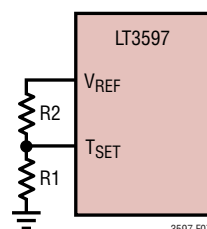

Figure 6. Programming the T_{SET} Pin

APPLICATIONS INFORMATION

Table 6 shows commonly used values for R1 and R2. Choose the ratio of R1 and R2 for the desired junction temperature limit as described in Figure 7.

Table 6. T_{SET} Programmed Junction Temperature

T _J (°C)	R1 (kΩ)	R2 (kΩ)
85	49.9	97.6
100	49.9	90.9
115	49.9	84.5

The T_{SET} pin must be tied to V_{REF} if the temperature protection feature is not desired.

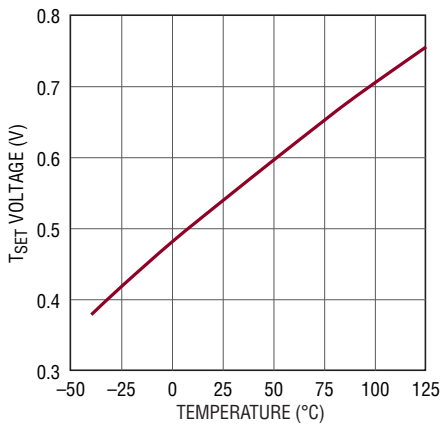

Figure 7. T_{SET} Voltage for Temperature Derating

LED Current Derating Using the CTRLM Pin

Another feature of the LT3597 is its ability to program a derating curve for maximum LED current versus temperature. LED data sheets provide curves of maximum allowable LED current versus temperature to warn against exceeding this current limit and damaging the LED. The LT3597 allows the output LEDs to be programmed for maximum allowable current while still protecting the LEDs from excessive currents at high temperature. This is achieved by programming a voltage at the CTRLM pin with a negative temperature coefficient using a resistor divider with temperature dependent resistance (Figure 8). As ambient temperature increases, the CTRLM voltage will fall below the internal 1V voltage reference, causing LED currents to be controlled by the CTRLM pin voltage. The LED current curve breakpoint and slope versus temperature are defined by the choice of resistor ratios and use of temperature-dependent resistance in the divider for the CTRLM pin.

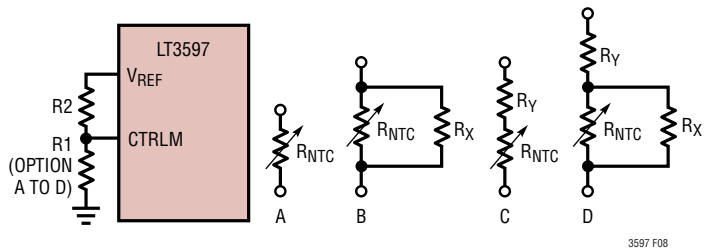

Figure 8. Programming the CTRLM Pin

3597 F08

APPLICATIONS INFORMATION

Table 7 shows a list of manufacturers/distributors of NTC resistors. There are several other manufacturers available and the chosen supplier should be contacted for more detailed information. If an NTC resistor is used to indicate LED temperature, it is effective only if the resistor is placed as closely as possible to the LED strings. LED derating curves shown by manufacturers are listed for ambient temperature. The NTC resistor should have the same ambient temperature as the LEDs. Since the temperature dependency of an NTC resistor can be non-linear over a wide range of temperatures, it is important to obtain a resistor's exact value over temperature from the manufacturer. Hand calculations of the CTRLM voltage can then be performed at each given temperature, resulting in the CTRLM versus temperature plotted curve. Iterations of resistor value calculations may be necessary to achieve the desired break point and slope of the LED current derating curve. From the CTRLM voltage, the LED current can be found using the curve shown in Figure 9.

Table 7. NTC Resistor Manufacturers/Distributors

Murata	www.murata.com
TDK Corporation	www.tdk.com
Digi-Key	www.digikey.com

If calculating the CTRLM voltage at various temperatures gives a downward slope that is too strong, use alternative resistor networks (B, C, D in Figure 8). They use temperature independent resistance to reduce the effects of the NTC resistor over temperature.

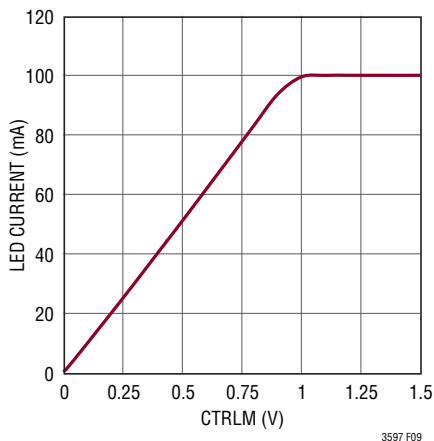

Figure 9. LED Current vs CTRLM Voltage

Murata Electronics provides a selection of NTC resistors with complete data over a wide range of temperatures. In addition, a software tool is available which allows the user to select from different resistor networks and NTC resistor values, and then simulate the exact output voltage curve (CTRLM behavior) over temperature. Referred to as the “Murata Chip NTC Thermistor Output Voltage Simulator,” users can log onto www.murata.com and download the software followed by instructions for creating an output voltage V_{OUT} (CTRLM) from a specified V_{CC} supply (V_{REF}).

The CTRLM pin must be tied to V_{REF} if the temperature derating function is not desired.

Programming Switching Frequency

The switching frequency of the LT3597 can be programmed between 200kHz and 1MHz by an external resistor connected between the RT pin and ground. Do not leave this pin open. See Table 8 and Figure 10 for resistor values and corresponding frequencies.

Table 8. R_T Resistor Selection

SWITCHING FREQUENCY (MHz)	R_T VALUE (k Ω)
1.0	33.2
0.5	80
0.2	220

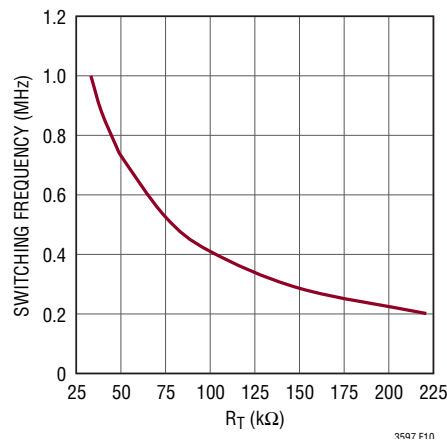

Figure 10. Programming Switching Frequency

APPLICATIONS INFORMATION

Selecting the optimum switching frequency depends on several factors. Inductor size is reduced with higher frequency, but efficiency drops slightly due to higher switching losses. Some applications require very low duty cycles to drive a small number of LEDs from a high supply. Low switching frequency allows a greater range of operational duty cycle and hence a lower number of LEDs can be driven. In each case, the switching frequency can be tailored to provide the optimum solution. When programming the switching frequency, the total power losses within the IC should be considered.

Switching Frequency Synchronization

The nominal operating frequency of the LT3597 is programmed using a resistor from the RT pin to ground over a 200kHz to 1MHz range. In addition, the internal oscillator can be synchronized to an external clock applied to the SYNC pin. The synchronizing clock signal input to the LT3597 must have a frequency between 240kHz and 1MHz, a duty cycle between 20% and 80%, a low state below 0.4V and a high state above 1.6V. Synchronization signals outside of these parameters will cause erratic switching behavior. For proper operation, an R_T resistor is chosen to program a switching frequency 20% slower than the SYNC pulse frequency. Synchronization occurs at a fixed delay after the rising edge of SYNC.

The SYNC pin must be grounded if the clock synchronization feature is not used. When the SYNC pin is grounded, the internal oscillator controls the switching frequency of the converter.

Operating Frequency Trade-offs

Selection of the operating frequency is a trade-off between efficiency, component size, output voltage and maximum input voltage. The advantage of high frequency operation is smaller component sizes and values. The disadvantages are lower efficiency and lower input voltage range for a desired output voltage. The highest acceptable switching frequency ($f_{SW(MAX)}$) for a given application can be calculated as follows:

$$f_{SW(MAX)} = \frac{V_D + V_{OUT}}{t_{ON(MIN)}(V_D + V_{IN} - V_{SW})}$$

where V_{IN} is the typical input voltage, V_{OUT} is the output voltage, V_D is the catch diode drop (0.5V) and V_{SW} is the internal switch drop (0.5V at max load). This equation shows that slower switching is necessary to accommodate high V_{IN}/V_{OUT} ratios. The reason the input voltage range depends on the switching frequency is due to the finite minimum switch on and off times. The switch minimum on and off times are 200ns.

Adaptive Loop Control

The LT3597 uses an adaptive control mechanism to set the buck output voltage. This control scheme ensures maximum efficiency while not compromising minimum PWM pulse widths. When PWM1-3 is low, the output of the respective buck rises to a maximum value set by an external resistor divider to the respective FB pin. Once PWM1-3 goes high, the output voltage is adaptively reduced until the voltage across the LED current sink is 1V. Figure 11 shows how the maximum output voltage can be set by an external resistor divider.

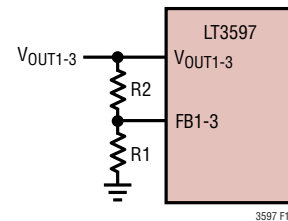

Figure 11. Programming Maximum V_{OUT1-3}

The maximum output voltage must be set to exceed the maximum LED drop plus 1V by a margin greater than 10%. However, this margin must not exceed a voltage of 10V. This ensures proper adaptive loop control. The equations below are used to estimate the resistor divider ratio. The sum of the resistors should be less than 100k to avoid noise coupling to the FB pin.

$$V_{OUT(MAX)} = 1.1(V_{LED(MAX)} + 1.1V) = 1.2V \cdot \left(1 + \frac{R2}{R1}\right)$$

$$V_{OUT(MAX)} = V_{LED(MAX)} + 1.1V + V_{MARGIN}$$

$$V_{MARGIN} \leq 10V$$

APPLICATIONS INFORMATION

Minimum Input Voltage

The minimum input voltage required to generate an output voltage is limited by the maximum duty cycle and the output voltage (V_{OUT}) set by the FB resistor divider. The duty cycle is:

$$DC = \frac{V_D + V_{OUT}}{V_{IN} - V_{CESAT} + V_D}$$

where V_D is the Schottky forward drop and V_{CESAT} is the saturation voltage of the internal switch. The minimum input voltage is:

$$V_{IN(MIN)} = \left(\frac{V_D + V_{OUT(MAX)}}{DC_{MAX}} \right) + V_{CESAT} - V_D$$

where $V_{OUT(MAX)}$ is calculated from the equation in the Adaptive Loop Control section, and DC_{MAX} is the minimum rating of the maximum duty cycle.

Fault Flag

The \overline{FAULT} pin is an open-collector output and needs an external resistor tied to a supply. If the LED1-3 pin voltage exceeds 12V or if the LED1-3 pin voltage is within 1.25V of V_{OUT1-3} pins while PWM1-3 is high, the \overline{FAULT} pin will be pulled low. The \overline{FAULT} pin will also be pulled low if the internal junction temperature exceeds the T_{SET} programmed temperature limit.

There is an approximate 3 μ s delay for \overline{FAULT} flag generation when the PWM1-3 signal is enabled to avoid generating a spurious flag signal. The maximum current the \overline{FAULT} can sink is typically 200 μ A.

Thermal Considerations

The LT3597 provides three channels for LED strings with internal NPN devices serving as constant current sources. When LED strings are regulated, the lowest LED pin voltage is typically 1V. More power dissipation occurs in the

LT3597 at higher programmed LED currents. For 100mA of LED current with a 100% PWM dimming ratio, at least 300mW is dissipated within the IC due to current sources. Thermal calculations must include the power dissipation in the current sources in addition to conventional switch DC loss, switch transient loss and input quiescent loss.

In addition, the die temperature of the LT3597 must be lower than the maximum rating of 125°C. This is generally not a concern unless the ambient temperature is above 100°C. Care should be taken in the board layout to ensure good heat sinking of the LT3597. The maximum load current should be derated as the ambient temperature approaches 125°C. The die temperature rise above ambient is calculated by multiplying the LT3597 power dissipation by the thermal resistance from junction to ambient. Power dissipation within the LT3597 is estimated by calculating the total power loss from an efficiency measurement and subtracting the losses of the catch diode and the inductor. Thermal resistance depends on the layout of the circuit board, but 32°C/W is typical for the 5mm \times 8mm QFN package.

Board Layout

As with all switching regulators, careful attention must be paid to the PCB board layout and component placement. To prevent electromagnetic interference (EMI) problems, proper layout of high frequency switching paths is essential. Minimize the length and area of all traces connected to the switching node pin (SW). Always use a ground plane under the switching regulator to minimize inter-plane coupling. Good grounding is essential in LED fault detection.

Proper grounding is also essential for the external resistors and resistor dividers that set critical operation parameters. Both the LT3597 exposed pad and pin 18 are ground. Resistors connected between ground and the CTRL1-3, CTRLM, FB1-3, T_{SET} , I_{SET1-3} , RT and EN/UVLO pins are best tied to pin 18 and not the ground plane.

TYPICAL APPLICATIONS

48V 1MHz Triple Step-Down 100mA RGB LED Driver

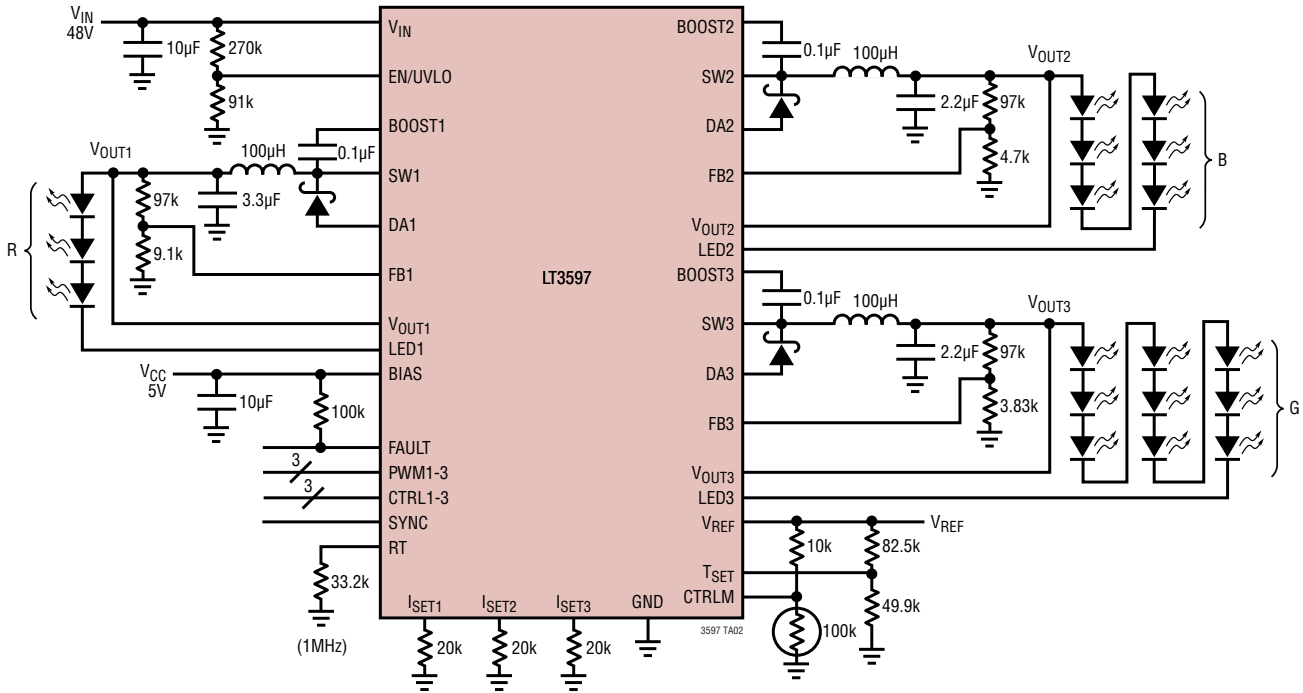

Efficiency

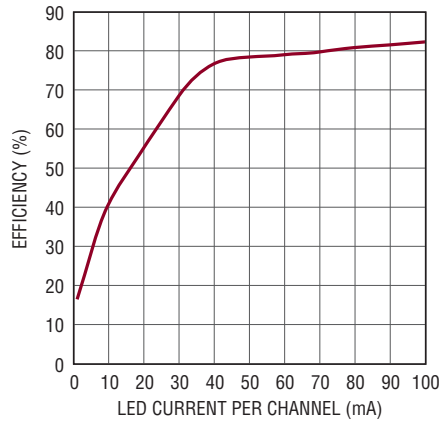

3597 TA02b

TYPICAL APPLICATIONS

48V 1MHz Triple Step-Down 10W 100mA White LED Driver (3.6V LEDs)

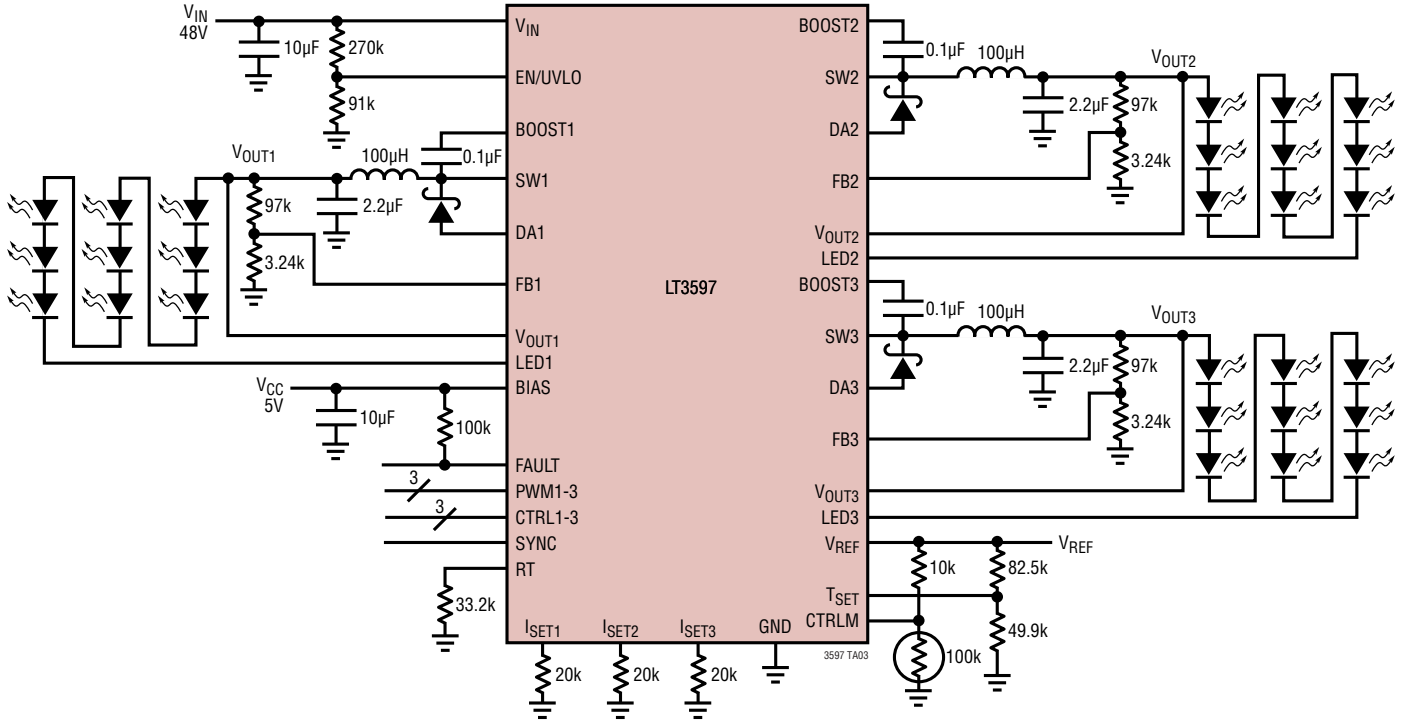

Efficiency

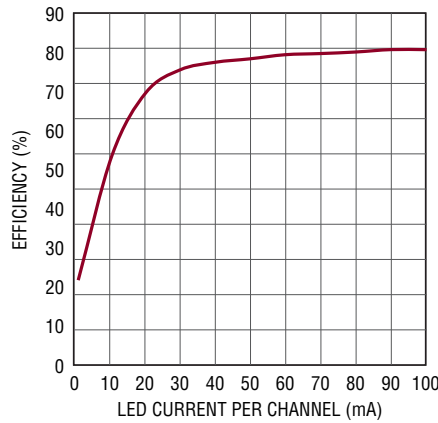

3597 TA03b

TYPICAL APPLICATIONS

24V 200kHz Triple Step-Down 100mA RGB LED Driver

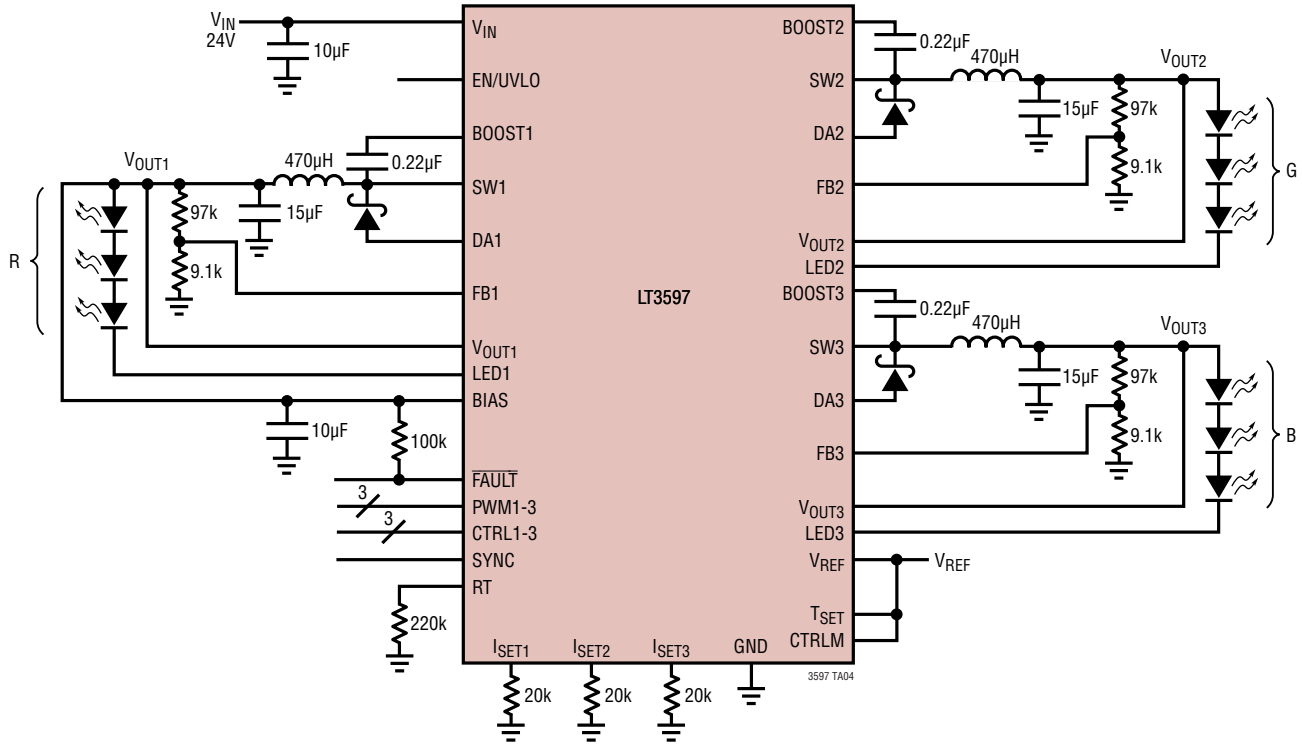

Efficiency

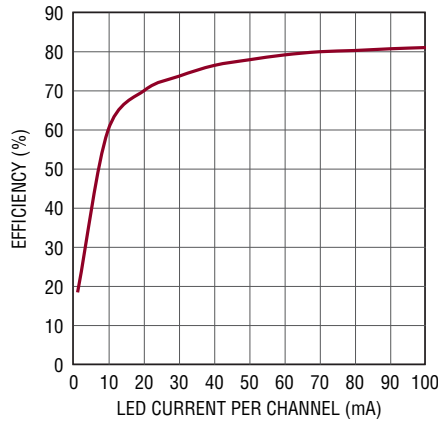

3597 TA04b

TYPICAL APPLICATIONS

48V 1MHz Triple Step-Down 20mA RGB LED Driver

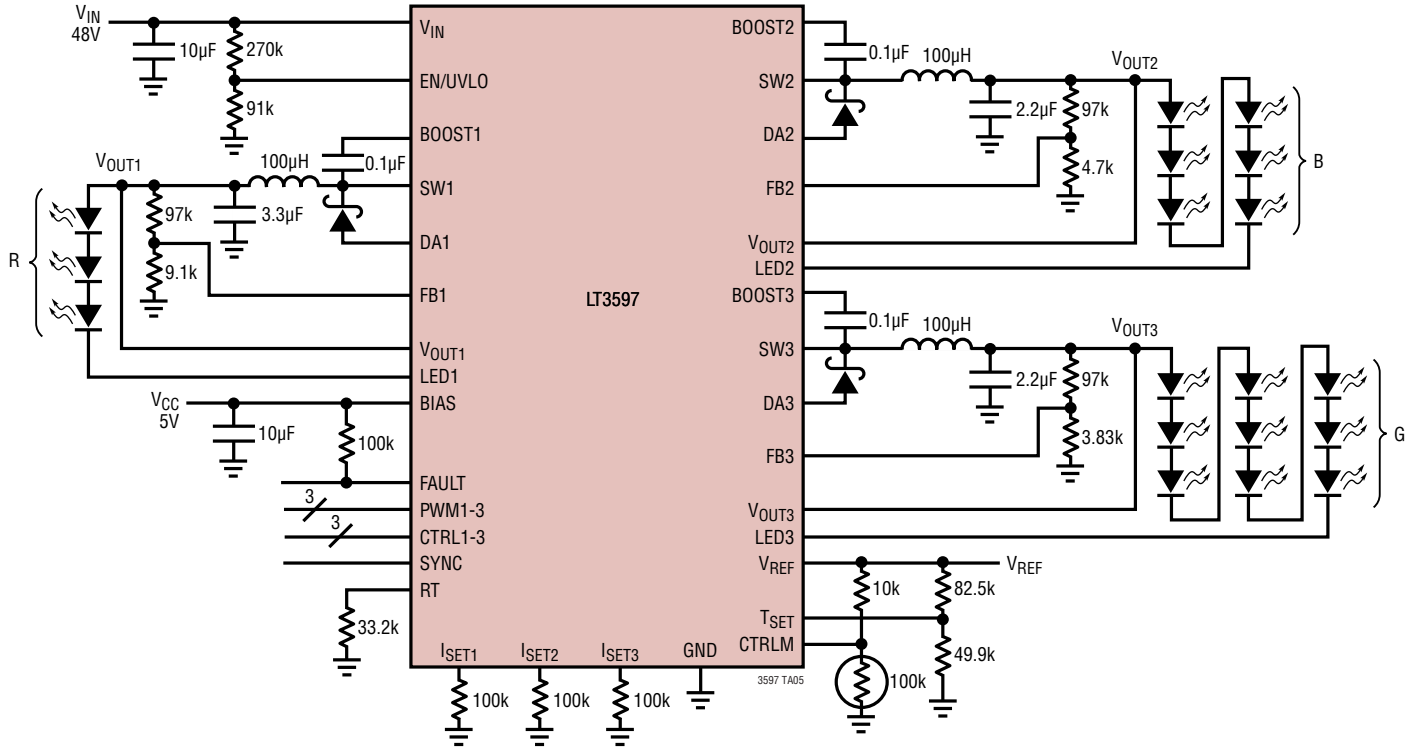

PACKAGE DESCRIPTION

UHG Package
Variation: UHG52 (39)
52-Lead Plastic QFN (5mm × 8mm)
 (Reference LTC DWG # 05-08-1846 Rev B)

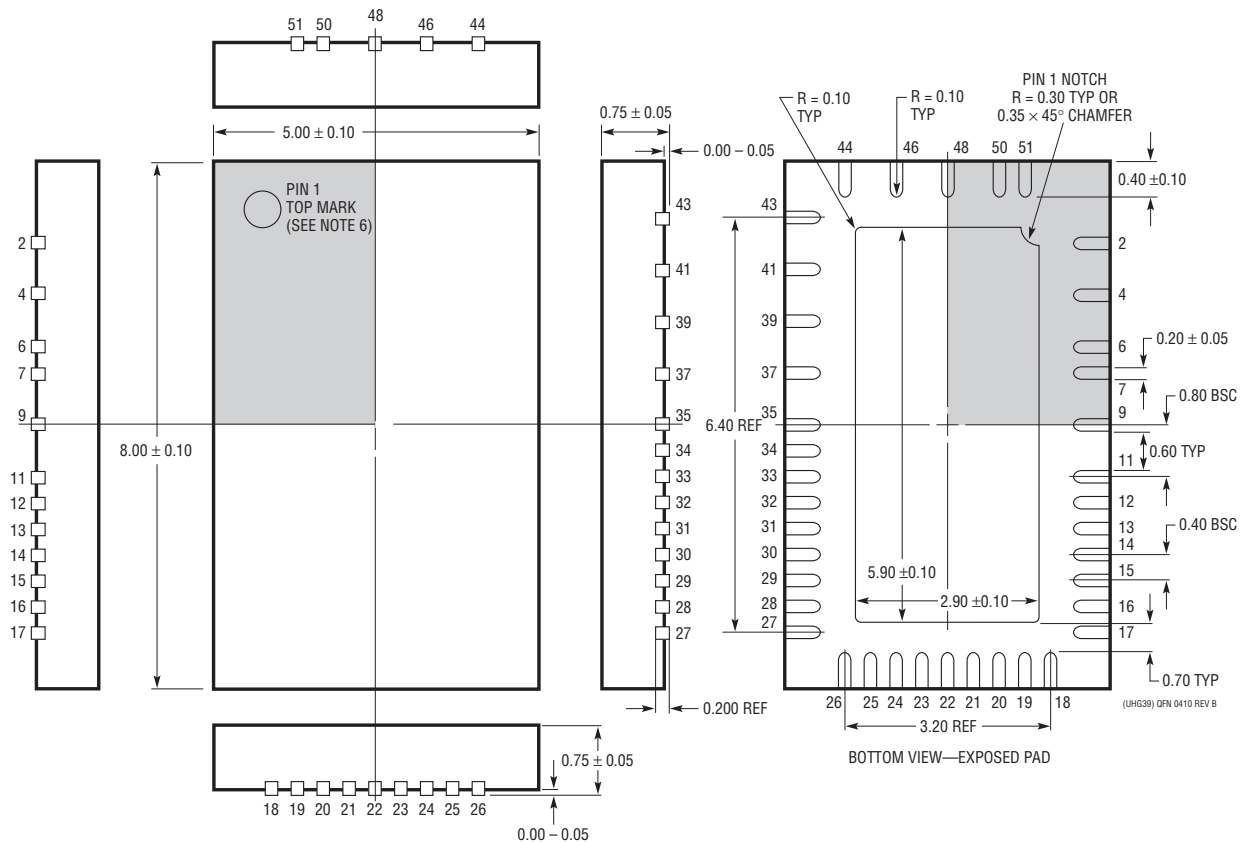
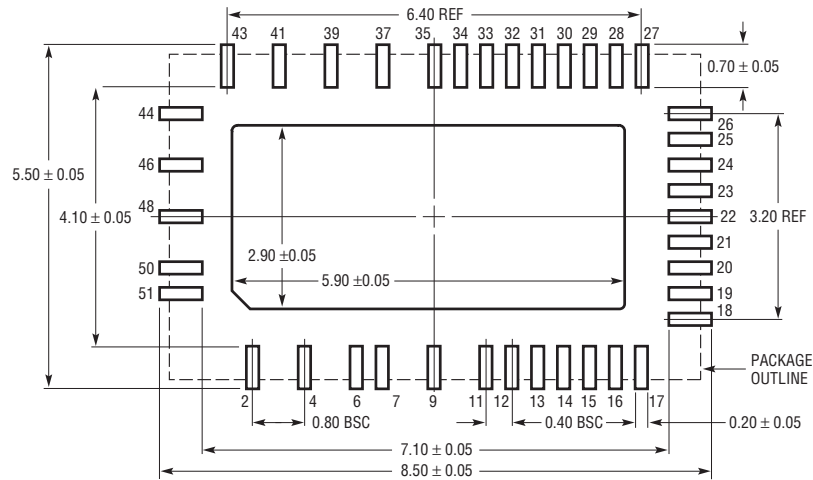

- NOTE:
1. DRAWING IS NOT A JEDEC PACKAGE OUTLINE
 2. DRAWING NOT TO SCALE
 3. ALL DIMENSIONS ARE IN MILLIMETERS
 4. DIMENSIONS OF EXPOSED PAD ON BOTTOM OF PACKAGE DO NOT INCLUDE MOLD FLASH. MOLD FLASH, IF PRESENT, SHALL NOT EXCEED 0.20mm ON ANY SIDE
 5. EXPOSED PAD SHALL BE SOLDER PLATED
 6. SHADED AREA IS ONLY A REFERENCE FOR PIN 1 LOCATION ON THE TOP AND BOTTOM OF PACKAGE

REVISION HISTORY

REV	DATE	DESCRIPTION	PAGE NUMBER
A	7/11	Revised Maximum limit for LED1-3 Pin Leakage Current in the Electrical Characteristics section. Made text edits in 'LED Current Derating Using the CTRLM Pin' and 'Fault Flag' sections in the Applications Information section.	4 15, 17