

## FEATURES

- Up to 45V of LEDs × 50mA, 16-Channel LED Driver
- Wide Input Range : 6V to 40V (4.5V to 13V,  $V_{IN}$  Connected to  $INTV_{CC}$ )
- $\pm 2.8\%$  LED Current Matching at 20mA (Typ  $\pm 0.7\%$ )
- Up to 3000:1 True Color PWM™ Dimming Range
- Single Resistor Sets LED Current (10mA to 50mA)
- LED Current Regulated Even for  $PV_{IN} > V_{OUT}$
- Output Adapts to LED  $V_F$  for Optimum Efficiency
- Fault Flag + Protection for Open LED Strings
- Protection for LED Pin to  $V_{OUT}$  Short
- Parallel Channels for Higher LED Current
- Programmable LED Current Derating vs Temperature
- Accurate Undervoltage Lockout Threshold with Programmable Hysteresis
- Programmable Frequency (100kHz to 1MHz)
- Synchronizable to an External Clock

## APPLICATIONS

- Automotive, Notebook and TV Monitor Backlighting

LT, LT, LTC and LTM, Linear Technology and the Linear logo are registered trademarks of Linear Technology Corporation. True Color PWM is a trademark of Linear Technology Corporation. All other trademarks are the property of their respective owners. Protected by U.S. Patents, including 7199560, 7321203.

## DESCRIPTION

The LT<sup>®</sup>3754 is a 16-channel LED driver with a step-up DC/DC controller capable of driving up to 45V of LEDs. Each channel contains an accurate current sink with  $\pm 2.8\%$  current matching. Channels follow a master programmable current to allow between 10mA to 50mA of LED current per string. Channels can be paralleled for higher LED current. Output voltage adapts to variations in LED  $V_F$  for optimum efficiency and open LED faults do not affect the operation of connected LED strings.

The LT3754 allows a PWM dimming range up to 3000:1 and an analog dimming range up to 25:1. Operating frequency can be programmed from 100kHz up to 1MHz using a single resistor or synchronized to an external clock.

Additional features include: programmable maximum  $V_{OUT}$  for open LED protection, a fault flag for open LED, programmable LED current derating vs temperature, micropower shutdown and internal soft-start. The LT3754 is available in a thermally enhanced 5mm × 5mm 32-pin QFN package.

## TYPICAL APPLICATION

92% Efficient, 36W Backlight LED Driver

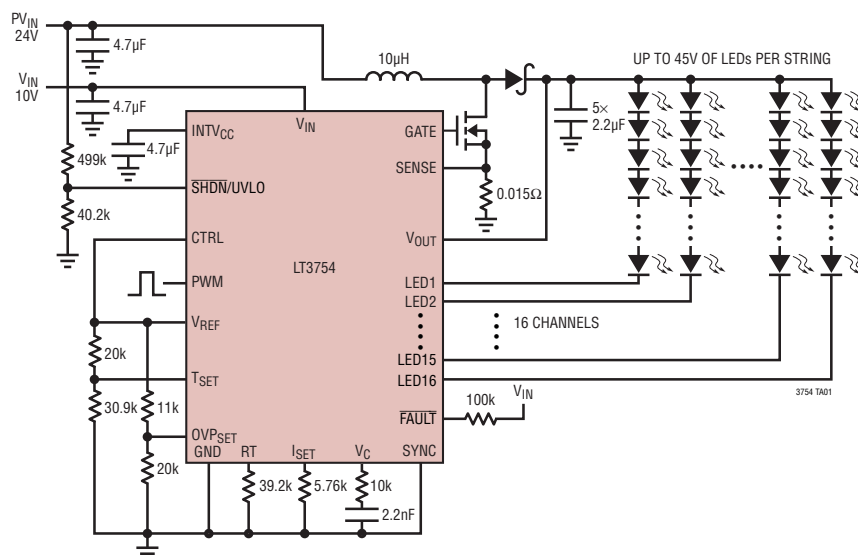

Worst-Case Channels LED Current Matching  
 (Normalized to 16-Channel Average)

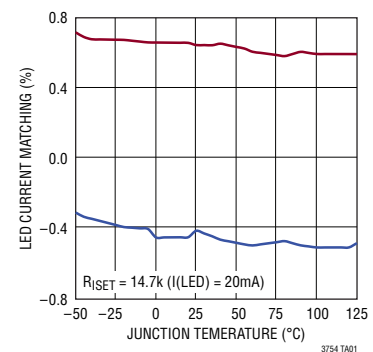

# LT3754

## ABSOLUTE MAXIMUM RATINGS

(Note 1)

$V_{OUT}$ , LED1-16 .....	60V
$V_{IN}$ , SHDN/UVLO, $\overline{FAULT}$ .....	40V
$INTV_{CC}$ .....	13V
$INTV_{CC}$ above $V_{IN}$ .....	+0.3V
PWM, CTRL, SYNC .....	6V
$V_C$ .....	3V
$V_{REF}$ , RT, $I_{SET}$ , $T_{SET}$ , $OVP_{SET}$ .....	2V
SENSE .....	0.4V
Operating Junction Temperature Range (Notes 2,3) .....	-40°C to 125°C
Storage Temperature Range .....	-65°C to 150°C

## PIN CONFIGURATION

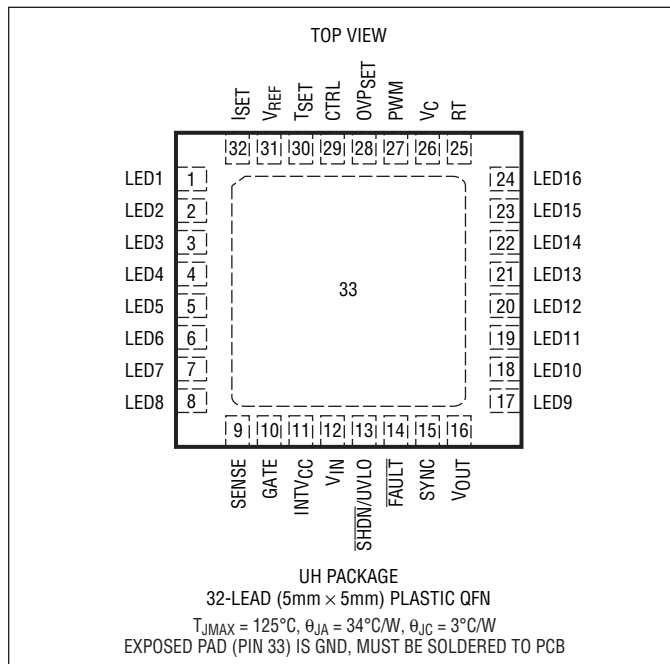

## ORDER INFORMATION

LEAD FREE FINISH	TAPE AND REEL	PART MARKING*	PACKAGE DESCRIPTION	TEMPERATURE RANGE
LT3754EUH#PBF	LT3754EUH#TRPBF	3754	32-Lead (5mm × 5mm) Plastic QFN	-40°C to 125°C
LT3754IUH#PBF	LT3754IUH#TRPBF	3754	32-Lead (5mm × 5mm) Plastic QFN	-40°C to 125°C

Consult LTC Marketing for parts specified with wider operating temperature ranges. \*The temperature grade is identified by a label on the shipping container. Consult LTC Marketing for information on non-standard lead based finish parts.

For more information on lead free part marking, go to: <http://www.linear.com/leadfree/>

For more information on tape and reel specifications, go to: <http://www.linear.com/tapeandreeel/>

**ELECTRICAL CHARACTERISTICS** The ● denotes the specifications which apply over the full operating temperature range, otherwise specifications are at  $T_A = 25^\circ\text{C}$ .  $V_{IN} = V_{OUT} = 6\text{V}$ ,  $R_{ISET} = 14.7\text{k}$  unless otherwise noted.

PARAMETER	CONDITIONS	MIN	TYP	MAX	UNITS	
<b>INPUT BIAS, REFERENCE</b>						
Minimum Operational $V_{IN}$ (To Allow GATE Switching)	$V_C = 1.5\text{V}$ $V_{IN} = \text{INTV}_{CC}$ (Shorted) $V_{IN} \neq \text{INTV}_{CC}$	● ●	4.2 5.5	4.5 6.0	V V	
Operational $V_{IN}$	$V_{IN} = \text{INTV}_{CC}$ (Shorted) $V_{IN} \neq \text{INTV}_{CC}$	4.5 6		13 40	V V	
$V_{IN}$ Quiescent Current	$\text{LED}_x = 1.2\text{V}$ $\text{CTRL} = 0.1\text{V}$ , $\text{PWM} = 0\text{V}$ $\text{CTRL} = 0.1\text{V}$ , $\text{PWM} = 1.5\text{V}$ , (Not Switching)		4.2 9.5	5.7 12	mA mA	
$V_{IN}$ Shutdown Current ( $V_{IN} \neq \text{INTV}_{CC}$ ) (Not Shorted)	$\text{SHDN}/\text{UVLO} = 0\text{V}$ , $V_{IN} = 6\text{V}$ $\text{SHDN}/\text{UVLO} = 0\text{V}$ , $V_{IN} = 40\text{V}$		0.1	2 10	$\mu\text{A}$ $\mu\text{A}$	
$V_{IN}$ Shutdown Current ( $V_{IN} = \text{INTV}_{CC}$ (Shorted))	$\text{SHDN}/\text{UVLO} = 0\text{V}$ , $V_{IN} = \text{INTV}_{CC} = 4.5\text{V}$ $\text{SHDN}/\text{UVLO} = 0\text{V}$ , $V_{IN} = \text{INTV}_{CC} = 13\text{V}$		10 20	20 40	$\mu\text{A}$ $\mu\text{A}$	
$\text{SHDN}/\text{UVLO}$ Threshold (Micropower) (Falling) ( $V_{SD}$ )	$I_{VIN} < 20\mu\text{A}$	●	0.3	0.7	V	
$\text{SHDN}/\text{UVLO}$ Threshold (UVLO) (Falling) (Stop Switching) ( $V_{UV}$ )		●	1.414	1.476	1.538	V
$\text{SHDN}/\text{UVLO}$ Pin Current	$\text{SHDN}/\text{UVLO} = V_{UV} - 50\text{mV}$ $\text{SHDN}/\text{UVLO} = V_{UV} + 50\text{mV}$	●	1.6	2.4 0	$\mu\text{A}$ $\mu\text{A}$	
$V_{REF}$ Voltage	$I_{VREF} = 0\mu\text{A}$	●	1.450	1.485	1.524	V
$V_{REF}$ Line Regulation	$I_{VREF} = 0\mu\text{A}$ , $6\text{V} < V_{IN} < 40\text{V}$			0.01	0.05	%/V
$V_{REF}$ Load Regulation	$0 < I_{VREF} < 150\mu\text{A}$ (Max)			2		mV
<b>OSCILLATOR</b>						
Frequency: $f_{OSC}$ (100kHz)	$R_T = 523\text{k}$	●	92	101	112	kHz
Frequency: $f_{OSC}$ (1MHz)	$R_T = 39.2\text{k}$	●	0.90	1	1.10	MHz
$f_{OSC}$ (1MHz) Line Regulation	$R_T = 39.2\text{k}$ , $6\text{V} < V_{IN} < 40\text{V}$			0.1	0.2	%/V
$R_T$ Pin Voltage	$R_T = 39.2\text{k}$			1.6		V
Minimum Off-Time	(Note 5)			170	250	nS
Minimum On-Time	(Note 5)			190	250	nS
SYNC Input High Threshold					2.2	V
SYNC Input Low Threshold			0.6			V
SYNC Input Current	$\text{SYNC} = 0\text{V}$ $\text{SYNC} = 5\text{V}$			0 25		$\mu\text{A}$ $\mu\text{A}$
SYNC Frequency Range	$R_T = 523\text{k}$ $R_T = 39.2\text{k}$		0.12 1.2		1.5 1.5	MHz MHz
<b>LINEAR REGULATOR (INTV<sub>CC</sub>)</b>						
INTV <sub>CC</sub> Regulation Voltage	$V_{IN} = 12\text{V}$		6.65	7	7.35	V
Dropout ( $V_{IN} - \text{INTV}_{CC}$ )	$I_{\text{INTV}_{CC}} = 10\text{mA}$			250		mV
INTV <sub>CC</sub> UVLO (+)	(Start Switching)			3.8		V
INTV <sub>CC</sub> UVLO (-)	(Stop Switching)			3.4		V
INTV <sub>CC</sub> Current Limit		●	44	57		mA
<b>OVP/LED ERROR AMPLIFIERS</b>						
Transconductance (OVP)	$\Delta I_{VC} = \pm 2.5\mu\text{A}$			4		$\mu\text{mhos}$
Voltage Gain (OVP)				5		V/V
Transconductance (LED)	$\Delta I_{VC} = \pm 2.5\mu\text{A}$			33		$\mu\text{mhos}$

## ELECTRICAL CHARACTERISTICS

The ● denotes the specifications which apply over the full operating temperature range, otherwise specifications are at  $T_A = 25^\circ\text{C}$ .  $V_{IN} = V_{OUT} = 6\text{V}$ ,  $R_{ISET} = 14.7\text{k}$  unless otherwise noted.

PARAMETER	CONDITIONS	MIN	TYP	MAX	UNITS	
Voltage Gain (LED)			45		V/V	
$V_C$ Source Current (Out of Pin)	$V_C = 1.5\text{V}$ , $V_{LEDx} = 0.8\text{V}$ , $OVP_{SET} = 1.5\text{V}$		10		$\mu\text{A}$	
$V_C$ Sink Current (OVP)	$V_C = 1.5\text{V}$ , $V_{LEDx} = 0.8\text{V}$ , $OVP_{SET} = 0\text{V}$		15		$\mu\text{A}$	
$V_C$ Sink Current (LED)	$V_C = 1.5\text{V}$ , $V_{LEDx} = 1.2\text{V}$ , $OVP_{SET} = 1.5\text{V}$		9		$\mu\text{A}$	
$V_C$ Output High (clamp) ( $V_{COH}$ )			2.3		V	
$V_C$ Output Low (clamp) ( $V_{COL}$ )			0.8		V	
$V_C$ Switching Threshold ( $V_{CSW}$ )			1.1		V	
<b>SENSE AMP</b>						
SENSE Input Current (Out of Pin)	SENSE = 0V		65		$\mu\text{A}$	
SENSE Current Limit Threshold		● 46	52	60	mV	
Current Mode Gain	$\Delta V(V_C)/\Delta V(\text{SENSE})$		6		V/V	
SENSE Over Current Limit Threshold		● 90	100	110	mV	
<b>LED CURRENT / CONTROL</b>						
$I_{SET}$ Pin Voltage	CTRL = 1.5V		1.00		V	
LEDx Current (20mA) ( $R_{ISET} = 14.7\text{k}$ )	$V_{LEDx} = 1\text{V}$ , CTRL = 1.5V		19.29	20.2	21.11	mA
LEDx Current Matching (20mA) ( $R_{ISET} = 14.7\text{k}$ )	$V_{LEDx} = 1\text{V}$ , CTRL = 1.5V	●	$\pm 0.7$	$\pm 2.8$	%	
LEDx Current (50mA) ( $R_{ISET} = 5.76\text{k}$ )	$V_{LEDx} = 1\text{V}$ , CTRL = 1.5V		47.85	50.1	52.35	mA
LED Pin Regulation Voltage			1.1		V	
$T_{SET}$ Threshold			630		mV	
<b>ANALOG DIMMING</b>						
CTRL Input Current (Out of Pin)	CTRL = 1V CTRL = 0.04V		40 50	200 200	nA nA	
LEDx Current (Dimming 25:1)	$V_{LEDx} = 1\text{V}$ , CTRL = 0.04V		0.8		mA	
<b>PWM DIMMING</b>						
PWM Input Low Threshold		0.7	1		V	
PWM Input High Threshold			1.1	1.4	V	
PWM Input Current	PWM = 1.5V PWM = 6V		6 24		$\mu\text{A}$ $\mu\text{A}$	
$V_{OUT}$ Pin Current in PWM Mode ( $V_{OUT} = 60\text{V}$ )	PWM = 1.5V PWM = 0V		370 20		$\mu\text{A}$ $\mu\text{A}$	
LEDx Leakage Current (PWM = 0V)	$V_{LEDx} = 1\text{V}$ , $V_{OUT} = 12\text{V}$ $V_{LEDx} = 50\text{V}$ , $V_{OUT} = 60\text{V}$		0.1 0.1	1 2	$\mu\text{A}$ $\mu\text{A}$	
<b>FAULT DIAGNOSTICS</b>						
FAULT Output Sink Current	LED1 = Open, $V_{FAULT} = 0.3\text{V}$	0.3	0.6		mA	
LEDx Short Threshold ( $V_{SH}$ ) ( $V_{OUT} - V_{LEDx}$ )	$V_{OUT} = 12\text{V}$ $V_{OUT} = 60\text{V}$		6 6		V V	
LED Open Detection Threshold	$V_{OUT} = 12\text{V}$		0.5		V	

**ELECTRICAL CHARACTERISTICS** The ● denotes the specifications which apply over the full operating temperature range, otherwise specifications are at  $T_A = 25^\circ\text{C}$ .  $V_{IN} = V_{OUT} = 6\text{V}$ ,  $R_{ISET} = 14.7\text{k}$  unless otherwise noted.

PARAMETER	CONDITIONS	MIN	TYP	MAX	UNITS
<b>GATE DRIVER</b>					
GATE Driver Output Rise Time	$V_{IN} = 7\text{V}$ , $C_L = 3300\text{pF}$ (Note 4)		30		nS
GATE Driver Output Fall Time	$V_{IN} = 7\text{V}$ , $C_L = 3300\text{pF}$ (Note 4)		30		nS
GATE Output Low	$I_{GATE} = 0\mu\text{A}$			0.1	V
GATE Output High	$INTV_{CC} = V_{IN} = 7\text{V}$ $I_{GATE} = 0\mu\text{A}$		6.95		V
<b>OUTPUT VOLTAGE</b>					
$V_{OUT}$ Over Voltage Protection (OVP) Regulation Voltage	$OVP_{SET} = 0.22\text{V}$ $OVP_{SET} = 1\text{V}$		12.5 57		V V
$OVP_{SET}$ Input Current (Out of Pin)	$OVP_{SET} = 0.22\text{V}$ , $V_{OUT} = 12\text{V}$		40	200	nA

**Note 1:** Stresses beyond those listed under Absolute Maximum Ratings may cause permanent damage to the device. Exposure to any Absolute Maximum Rating condition for extended periods may affect device reliability and lifetime.

**Note 2:** The LT3754E is guaranteed to meet performance specifications from  $0^\circ\text{C}$  to  $125^\circ\text{C}$  junction temperature. Specifications over the  $-40^\circ\text{C}$  to  $125^\circ\text{C}$  operating junction temperature range are assured by design, characterization and correlation with statistical process controls. The

LT3754I is guaranteed to meet performance specifications from  $-40^\circ\text{C}$  to  $125^\circ\text{C}$  junction temperature.

**Note 3:** For Maximum Operating Ambient Temperature, see *Thermal Calculations* in the Applications Information section.

**Note 4:** GATE rise and fall times are measured between 10% and 90% of  $INTV_{CC}$  voltage.

**Note 5:** See Duty Cycle Considerations in the Applications Information.

**TYPICAL PERFORMANCE CHARACTERISTICS**  $T_A = 25^\circ\text{C}$ , unless otherwise noted.

**Worst-Case Channels LED Current Matching (Normalized to 16-channel Average)**

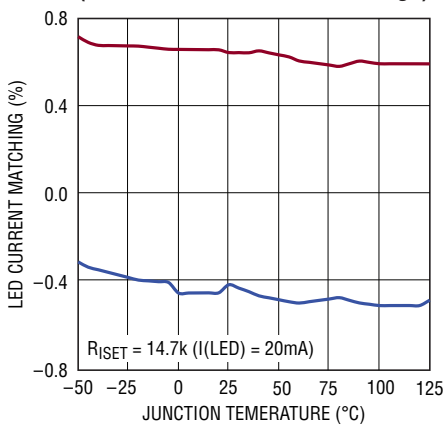

**LED Current vs Junction Temperature**

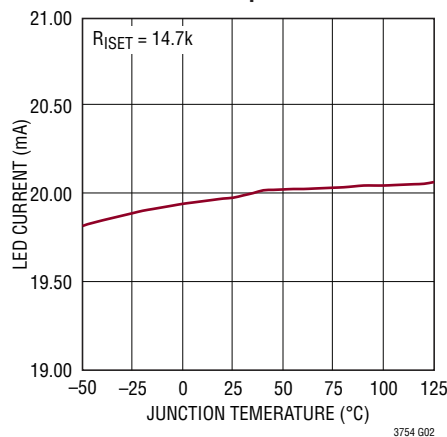

**LED Current vs CTRL Pin Voltage**

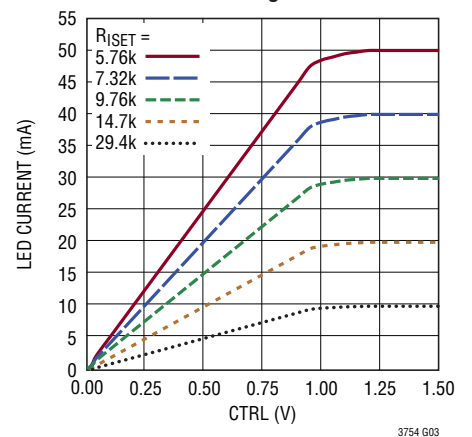

## TYPICAL PERFORMANCE CHARACTERISTICS $T_A = 25^\circ\text{C}$ , unless otherwise noted.

**LED Current Waveforms  
3000:1 PWM Dimming (100Hz)**

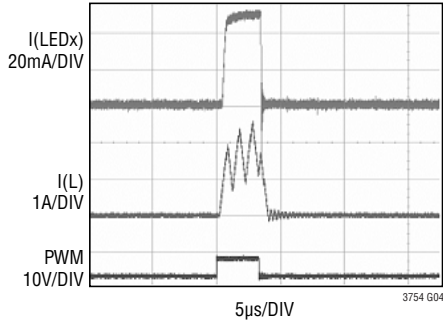

**$V_{REF}$  vs Junction Temperature**

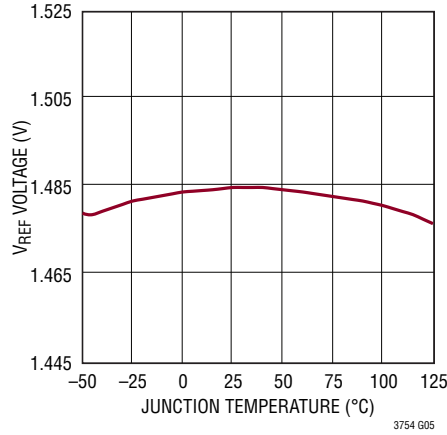

**$\overline{SHDN/UVLO}$  Threshold vs Junction Temperature**

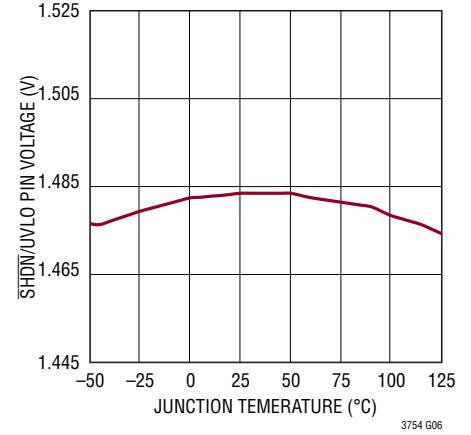

**$\overline{SHDN/UVLO}$  Pin (Hysteresis)  
Current vs Junction Temperature**

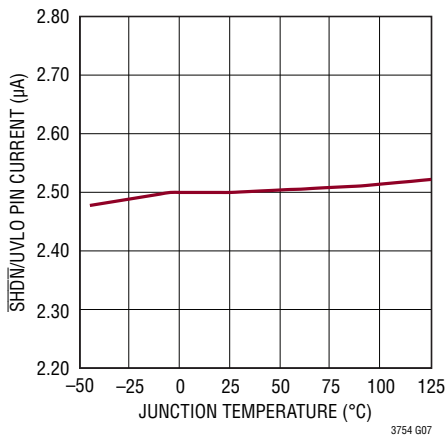

**$V_{IN}$  Shutdown Current vs Junction Temperature**

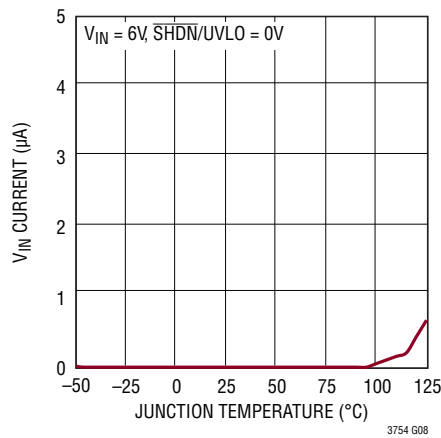

**$V_{IN}$  Quiescent Current vs  $V_{IN}$**

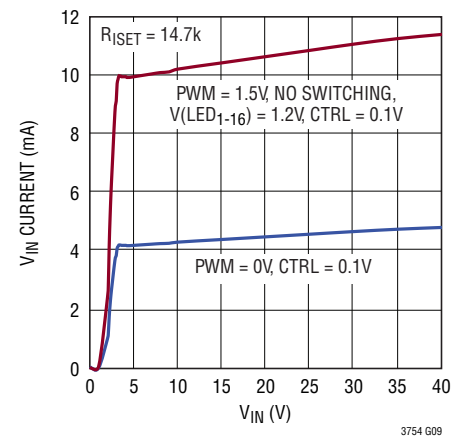

**$V_{IN}$  Quiescent Current vs Junction Temperature**

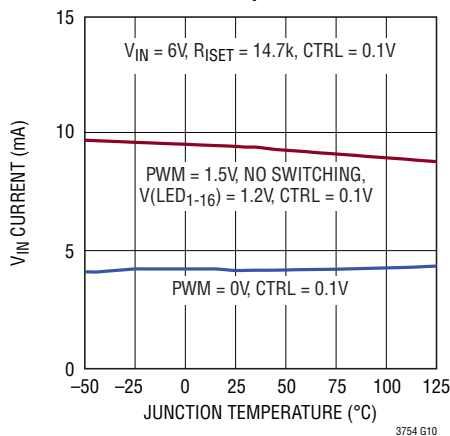

**Switching Frequency vs Junction Temperature**

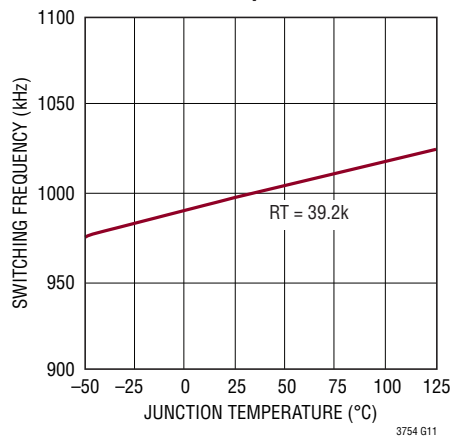

**$V_C$  High Clamp, Active and Low Clamp Levels vs Junction Temperature**

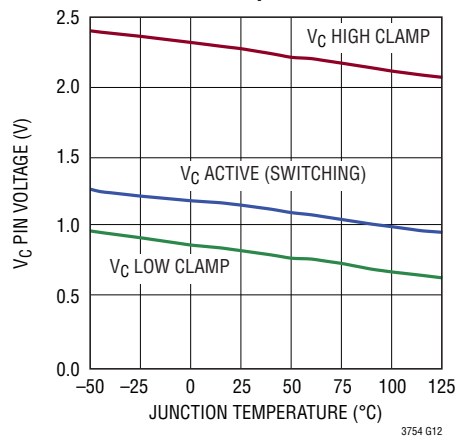

**TYPICAL PERFORMANCE CHARACTERISTICS**  $T_A = 25^\circ\text{C}$ , unless otherwise noted.

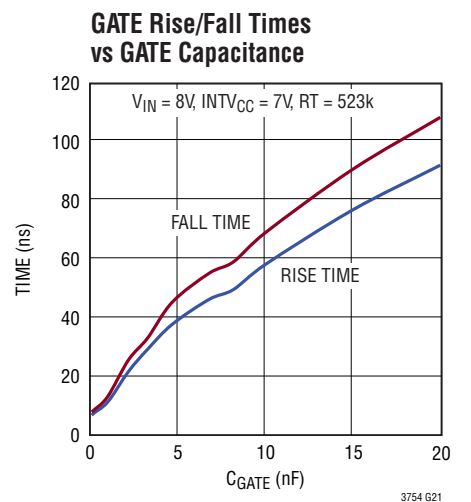
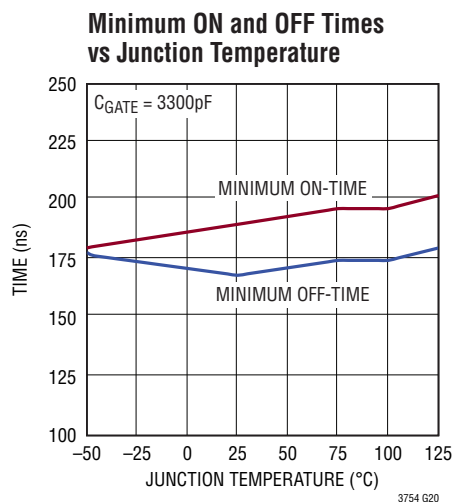
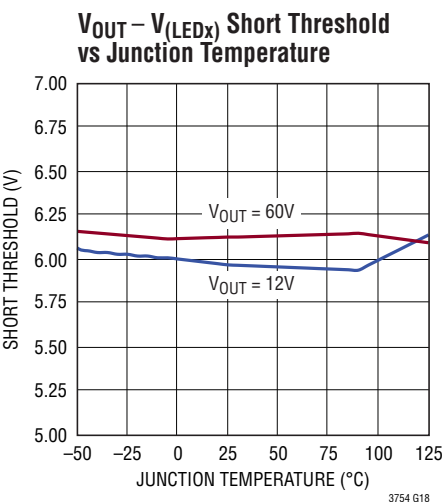
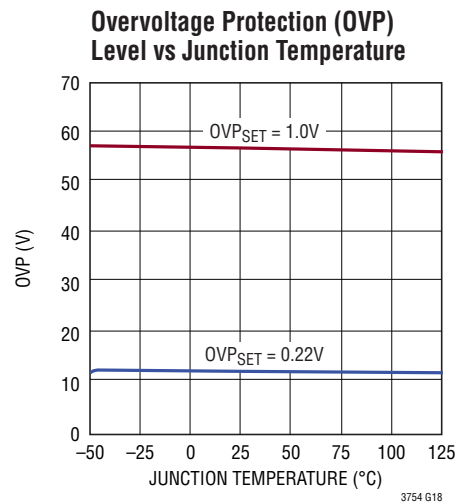
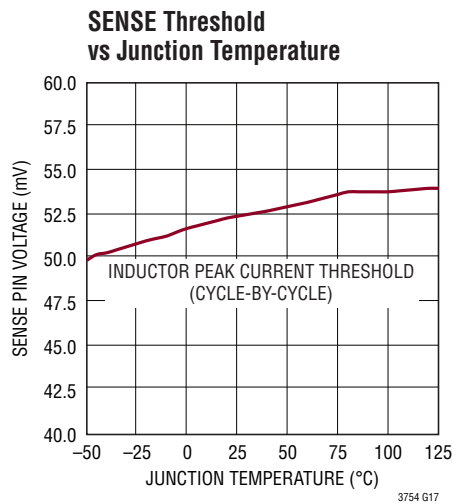
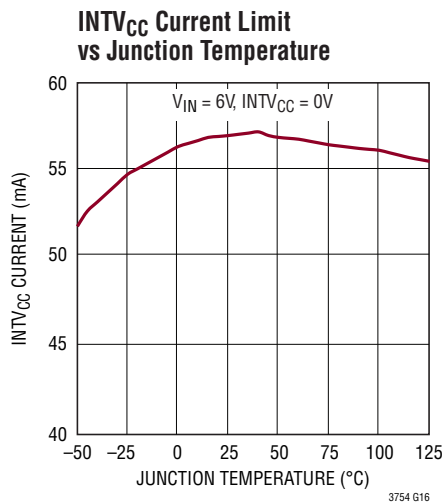
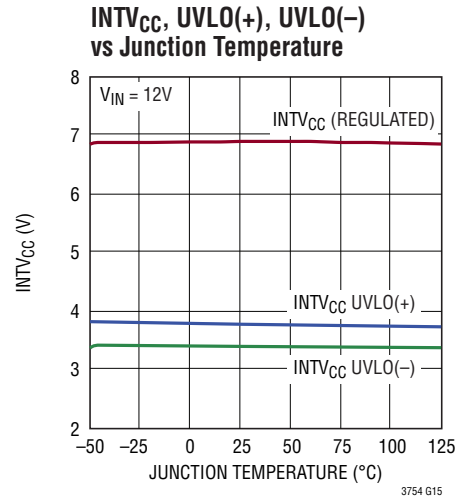
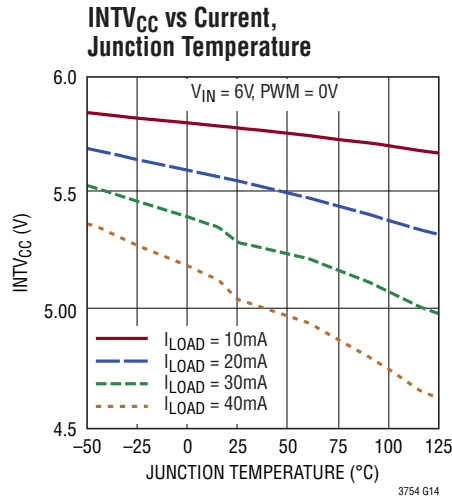
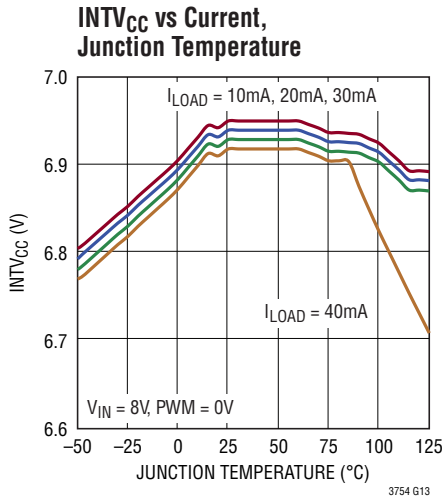

## PIN FUNCTIONS

**LED<sub>x</sub> (Pin 1-8,17-24):** 16 LED Driver Outputs. Each output contains an open collector constant current sink. LED currents are programmable from 10mA to 50mA using a single resistor at the I<sub>SET</sub> pin. Connect the cathode of each LED string to an LED pin. Connect the anode of each LED string to V<sub>OUT</sub>. Channels can be paralleled for greater LED current or individually disabled (connect LED to V<sub>OUT</sub>).

**SENSE (Pin 9):** The Current Sense Input for the Control Loop. Connect this pin to the sense resistor in the source of the external power MOSFET.

**GATE (Pin 10):** Drives the gate of an N-channel MOSFET from 0V to INTV<sub>CC</sub>.

**INTV<sub>CC</sub> (Pin 11):** A 7V LDO supply generated from V<sub>IN</sub> and used to power the GATE driver and some control circuitry. Must be bypassed with a 4.7μF capacitor to GND.

**V<sub>IN</sub> (Pin 12):** Input Supply Pin. Must be locally bypassed with a 1μF capacitor to ground.

**SHDN/UVLO (Pin 13):** The SHDN/UVLO pin has an accurate 1.476V threshold and can be used to program an under voltage lockout (UVLO) threshold for system input supply using a resistor divider from supply to ground. A 2.4μA pin current hysteresis allows programming of UVLO hysteresis. SHDN/UVLO above 1.476V turns the part on and removes a 2.4μA sink current from the pin. SHDN/UVLO < 0.7V reduces V<sub>IN</sub> current < 20μA. If the shutdown function is not required, it should be forced above 1.476V or connected directly to V<sub>IN</sub>.

**FAULT (Pin 14):** Active low if any or all LED strings have an open fault. If fault(s) removed, FAULT flag returns high. Fault status is only updated during PWM high state and latched during PWM low.

**SYNC (Pin 15):** Allows synchronization of boost converter switching frequency to an external clock. RT resistor should be programmed for f<sub>OSC</sub> 20% below SYNC frequency. If unused, connect to GND.

**V<sub>OUT</sub> (Pin 16):** Boosted Output Voltage of the Converter. Connect a capacitor from this pin to ground. Connect the anode of each LED (string) to V<sub>OUT</sub>.

**RT (Pin 25):** A resistor to ground programs switching frequency f<sub>OSC</sub> between 0.1MHz and 1MHz.

**V<sub>C</sub> (Pin 26):** Output of Both Transconductance Error Amplifiers for the Converter Regulation Loop. The most commonly used gm error amplifier (LED) regulates V<sub>OUT</sub> to ensure no LED pin falls below 1.1V. The other gm error amplifier (OVP) is activated if all LEDs fail open and a regulated maximum V<sub>OUT</sub> is required. Connect a resistor and capacitor in series from the V<sub>C</sub> pin to ground.

**PWM (Pin 27):** Input Pin for PWM Dimming Control. Above 1.4V allows converter switching and below 0.7V disables switching. The PWM signal can be driven from 0V to 6V. If unused, connect to V<sub>REF</sub>.

**OVP<sub>SET</sub> (Pin 28):** Programs maximum allowed V<sub>OUT</sub> regulation level if all LEDs are open circuit.

**CTRL (Pin 29):** CTRL pin voltage below 1V controls maximum LED current. CTRL voltage can be set by a resistor divider from V<sub>IN</sub>, V<sub>REF</sub> or an external voltage source. LED current derating versus temperature is achievable if the voltage programmed at the CTRL pin has a negative temperature coefficient using an external resistor divider from V<sub>REF</sub> pin with temperature dependent resistance.

**T<sub>SET</sub> (Pin 30):** Programs LT3754 junction temperature breakpoint past which LED current will begin to derate.

**V<sub>REF</sub> (Pin 31):** 1.485V Reference Output Pin. This pin can supply up to 150μA. Can be used to program CTRL, T<sub>SET</sub> and OVP<sub>SET</sub> pin voltages using resistor dividers to ground.

**I<sub>SET</sub> (Pin 32):** Resistor to Ground Programs LED pin current. See Table 6 in the Applications Information Section.

**Exposed Pad (Pin 33):** GND. The ground for the IC and the converter. The package has an exposed pad (Pin 33) underneath the IC which is the best path for heat out of the package. Pin 33 should be soldered to a continuous copper ground plane under the device to reduce die temperature and increase the power capability of the LT3754.





## OPERATION

to define the turn on/off voltages for  $V_{IN}$ .  $\overline{SHDN}/UVLO$  pin current switches from  $2.4\mu A$  to  $0\mu A$  when  $\overline{SHDN}/UVLO$  pin voltage exceeds  $1.476V$ .

The LT3754 constant switching frequency is programmable from  $100kHz$  up to  $1MHz$  using a single resistor at the RT pin to ground. A SYNC pin is also provided to allow an external clock to define the converter switching frequency. The GATE output provides a  $\pm 0.8A$  peak gate drive for an external N-channel power MOSFET to generate a boosted output voltage  $V_{OUT}$  using a single inductor, Schottky diode and output capacitor. With LED strings connected from  $V_{OUT}$  to every LED pin, the lowest voltage on each LED pin is monitored and compared to an internal  $1.1V$  reference.  $V_{OUT}$  is regulated to ensure the lowest LED pin voltage of any connected LED string is maintained at  $1.1V$ . If any of the LED strings are open, the LT3754 regulation loop will ignore the open LED pin. If all of the LED strings are open  $V_{OUT}$  charges up until a user programmable OVP (overvoltage protection) level is reached. This programmable OVP level allows the user to protect against LED damage when the LED strings are opened and then reconnected.

Since the LT3754 boost controller uses a current mode topology, the  $V_C$  pin voltage determines the peak current in the inductor of the converter and hence the duty cycle of the GATE switching waveform. The basic loop uses a pulse from an internal oscillator to set an RS flip-flop and turn on the external power MOSFET. Current increases in the MOSFET and inductor until the  $V_C$  commanded peak switch current is exceeded and the MOSFET is then turned off. Inductor current is sensed during the GATE on period by a sense resistor  $R_S$  in the source of the external N-channel power MOSFET. As with all current mode converters, slope compensation is added to the control path to ensure stability for duty cycles above 50%. Any over current fault condition in the MOSFET turns off the

MOSFET and triggers soft-start internally. In this fault mode the LT3754 only allows MOSFET turn-on approximately every 2ms. This hiccup mode significantly reduces the power rating required for the MOSFET.

LED current programming and dimming can be achieved using the  $I_{SET}$ , CTRL and PWM pins. A single resistor at the  $I_{SET}$  pin programs LED current. Analog dimming of LED brightness is achieved using the CTRL pin below  $1V$ . PWM dimming of LED brightness is achieved by controlling the duty cycle of the PWM pin.

For robust operation the LT3754 monitors system conditions and performs soft-start for start-up after any of the following faults:  $V_{IN}$ ,  $\overline{SHDN}$  or  $INTV_{CC}$  voltages too low or MOSFET current too high. The LT3754, when entering these faults, discharges an internal soft-start node and prevents switching at the GATE pin. When exiting these faults the LT3754 ramps up an internal soft-start node to control  $V_C$  pin voltage rise and hence control MOSFET peak switch current rise. In addition the soft-start period gradually ramps up switching frequency from approximately 33% to 100% of full scale.

The LT3754 monitors each LED pin voltage. If the LED string has an open fault ( $V(LED_x) < 0.5V$ ) the  $\overline{FAULT}$  flag is pulled low.

For LED protection, the LT3754 CTRL pin allows an LED current derating curve to be programmed versus the ambient temperature of the LED strings. An NTC resistor placed close to the LEDs decreases CTRL pin voltage and hence decreases LED current as LED ambient temperature increases.

The LT3754 also allows its own junction temperature to be monitored and regulated by derating LED currents when a junction temperature programmed by the  $T_{SET}$  pin is exceeded.

## APPLICATIONS INFORMATION

### INTV<sub>CC</sub> Regulator Bypassing and Operation

The INTV<sub>CC</sub> pin is the output of an internal linear regulator driven from V<sub>IN</sub> and is the supply for the LT3754 gate driver. The INTV<sub>CC</sub> pin should be bypassed with a 10V rated 4.7μF low ESR, X7R or X5R ceramic capacitor to ensure stability and to provide enough charge for the gate driver. For high enough V<sub>IN</sub> levels the INTV<sub>CC</sub> pin provides a regulated 7V supply. Make sure INTV<sub>CC</sub> voltage does not exceed the V<sub>GS</sub> rating of the external MOSFET driven by the GATE pin. For low V<sub>IN</sub> levels the INTV<sub>CC</sub> level will depend on V<sub>IN</sub> and the voltage drop of the regulator. The INTV<sub>CC</sub> regulator has an undervoltage lockout which prevents gate driver switching until INTV<sub>CC</sub> reaches 3.8V and maintains switching until INTV<sub>CC</sub> falls below 3.4V. This feature prevents excessive power dissipation in the external MOSFET by ensuring a minimum gate drive level to keep R<sub>DS(ON)</sub> low. The INTV<sub>CC</sub> regulator has a current limit of 44mA to limit power dissipation inside the I.C. This current limit should be considered when choosing the N-channel power MOSFET and the switching frequency. The average current load on the INTV<sub>CC</sub> pin due to the LT3754 gate driver can be calculated as:

$$I_{INTVCC} = Q_g \cdot f_{OSC}$$

where Q<sub>g</sub> is the gate charge (at V<sub>GS</sub> = INTV<sub>CC</sub>) specified for the MOSFET and f<sub>OSC</sub> is the switching frequency of the LT3754 boost converter. It is possible to drive the INTV<sub>CC</sub> pin from a variety of external sources in order to remove power dissipation from the LT3754 and/or to remove the INTV<sub>CC</sub> current limitation of 44mA. An external supply for INTV<sub>CC</sub> should never exceed the V<sub>IN</sub> pin voltage or the maximum INTV<sub>CC</sub> pin rating of 13V. If INTV<sub>CC</sub> is shorted to the V<sub>IN</sub> pin, V<sub>IN</sub> operational range is 4.5V to 13V.

### Inductor

A list of inductor manufacturers is given in Table 1. However, there are many other manufacturers and inductors that can be used. Consult each manufacturer for more detailed information and their entire range of parts. Ferrite cores should be used to obtain the best efficiency. Choose an inductor that can handle the necessary peak current without saturating. Also ensure that the inductor has a low DCR (copper-wire resistance) to minimize I<sup>2</sup>R power losses. Values between 2.2μH and 33μH will suffice for most applications. The typical inductor value required for a given application (assuming 50% inductor ripple current for example) can be calculated as:

$$L = \frac{\left(1 - \frac{1}{\frac{V_{OUT}}{V_{IN}}}\right) \cdot \frac{1}{f_{OSC}} \cdot V_{IN}}{0.5 \cdot \frac{V_{OUT}}{V_{IN}} \cdot I_{LEDx} \cdot 16}$$

where:

$$V_{OUT} = (N \cdot V_F) + 1V$$

(N = number of LEDs per string),

V<sub>F</sub> = LED forward voltage drop,

I<sub>LEDx</sub> = LED current per string

Example: For a 12W LED driver application requiring 16 strings of 10 LEDs each driven with 20mA, and choosing V<sub>IN</sub> = 12V, V<sub>OUT</sub> = (3.75V • 10) + 1V = 38.5V, I<sub>LEDx</sub> = 20mA and f<sub>OSC</sub> = 1MHz the value for L is calculated as

$$L = \frac{\left(1 - \frac{1}{3.2}\right) \cdot \frac{1}{10^6} \cdot 12V}{0.5 \cdot 3.2 \cdot 20mA \cdot 16} = 16.5\mu H$$

## APPLICATIONS INFORMATION

**Table 1. Inductor Manufacturers**

MANUFACTURER	PHONE NUMBER	WEB
Sumida	408-321-9660	www.sumida.com
Würth Elektronik	605-886-4385	www.we-online.com
Vishay	402-563-6866	www.vishay.com
Coilcraft	847-639-6400	www.coilcraft.com
Coiltronics	561-998-4100	www.cooperet.com

### Input Capacitor

The input capacitor of the LT3754 boost converter will supply the transient input current of the power inductor. Values between 2.2µF and 10µF will work well for the LT3754. Use only X5R or X7R ceramic capacitors to minimize variation over voltage and temperature. If inductor input voltage is required to operate near the minimum allowed operational  $V_{IN}$  for the I.C., a larger capacitor value may be required. This is to prevent excessive input voltage ripple causing dips below the minimum operating input voltage.

### Output Capacitor

Low ESR ceramic capacitors should be used at the LT3754 converter output to minimize output ripple voltage. Use only X5R or X7R dielectrics as these materials retain their capacitance over wider voltage and temperature ranges than other dielectrics. The output capacitance requirements for several LED driver application circuits are shown in the Applications Information section for various  $I_{LED}$ ,  $V_{IN}$ ,  $V_{OUT}$ , L and  $f_{OSC}$  values. Some suggested capacitor manufacturers are listed in Table 2.

**Table 2. Ceramic Capacitor Manufacturers**

MANUFACTURER	PHONE NUMBER	WEB
TDK	516-535-2600	www.tdk.com
Kemet	408-986-0424	www.kemet.com
Murata	814-237-1431	www.murata.com
Taiyo Yuden	408-573-4150	t-yuden.com
AVX	843-448-9411	www.avxcorp.com

### Schottky Rectifier

The external diode for the LT3754 boost converter must be a Schottky diode, with low forward voltage drop and fast switching speed. Table 3 lists several Schottky manufacturers. The diodes average current rating must exceed the application's average output current. The diode's maximum reverse voltage must exceed the maximum output voltage of the application. For PWM dimming applications be aware of the reverse leakage of the Schottky diode. Lower leakage current will drain the output capacitor less during PWM low periods, allowing for higher PWM dimming ratios. The companies below offer Schottky diodes with high voltage and current ratings.

**Table 3. Schottky Rectifier Manufacturers**

MANUFACTURER	PHONE NUMBER	WEB
Diodes, Inc.	805-446-4800	www.microsemi.com
On Semiconductor	888-743-7826	www.onsemi.com
Zetex	631-360-2222	www.zetex.com
Vishay Siliconix	402-563-6866	www.vishay.com

### Power MOSFET Selection

Several MOSFET vendors are listed in Table 4. Consult the factory applications department for other recommended MOSFETs. The power MOSFET selected should have a  $V_{DS}$  rating which exceeds the maximum Overvoltage Protection (OVP) level programmed for the application. (See "Programming OVP level" in the Applications Information section). The MOSFET should also have a low enough total gate charge  $Q_g$  (at 7V  $V_{GS}$ ) and a low enough switching frequency ( $f_{OSC}$ ) to not exceed the  $INTV_{CC}$  regulator current limit, where loading on  $INTV_{CC}$  pin due to gate switching should obey,

$$I_{GATE} = Q_g \cdot f_{OSC} \leq 44mA$$

## APPLICATIONS INFORMATION

In addition, the current drive required for GATE switching should also be kept low in the case of high  $V_{IN}$  voltages (see “Thermal Considerations” in the Applications Information section). The  $R_{DS(ON)}$  of the MOSFET will determine d.c. power losses but will usually be less significant compared to switching losses. Be aware of the power dissipation within the MOSFET by calculating d.c. and switching losses and deciding if the thermal resistance of the MOSFET package causes the junction temperature to exceed maximum ratings.

**Table 4. MOSFET Manufacturers**

MANUFACTURER	PHONE NUMBER	WEB
Vishay Siliconix	402-563-6866	www.vishay.com
International Rectifier	310-252-7105	www.irf.com
Fairchild	972-910-8000	www.fairchildsemi.com

### Power MOSFET: Current Sense Resistor

The LT3754 current mode boost converter controls peak current in the inductor by controlling peak MOSFET current in each switching cycle. The LT3754 monitors current in the external N-channel power MOSFET by sensing the voltage across a sense resistor (RS) connected between the source of the FET and the power ground in the application. The length of these tracks should be minimized and a Kelvin sense should be taken from the top of RS to the sense pin. A 52mV sense pin threshold combined with the value of RS sets the maximum cycle-by-cycle peak MOSFET current. The low 52mV threshold improves efficiency and determines the value for RS given by:

$$RS \leq \frac{52mV \cdot 0.7}{I_{L(PEAK)}}$$

where

$$I_{L(PEAK)} = \left( \left( \frac{1}{1-D} \right) \cdot 16 \cdot I_{LEDx} \right) \cdot \left( 1 + \frac{0.5}{2} \right)$$

$$D = \text{MOSFET duty cycle} = \left( 1 - \frac{V_{IN(MIN)}}{V_{OUT(MAX)}} \right)$$

$$V_{OUT(MAX)} = (N \cdot V_{F(MAX)}) + 1V$$

N = number of LEDs in each string,

$V_{F(MAX)}$  = maximum LED forward voltage drop,

$V_{IN(MIN)}$  = minimum input voltage to the inductor,

and the 0.5 term represents an inductor peak-to-peak ripple current of 50% of average inductor current.

The scale factor of • 0.7 ensures the boost converter can meet the peak inductor requirements of the loop by accounting for the combined errors of the 52mV sense threshold,  $I_{LEDx}$ , RS and circuit efficiency.

Example: For a 12W LED driver application requiring 16 strings of 10 LEDs each driven with 20mA, and choosing  $V_{IN(MIN)} = 8V$ ,  $V_{OUT(MAX)} = (4V \cdot 10) + 1V = 41V$  and  $I_{LEDx} = 20mA$ , the value for RS is chosen as:

$$RS \leq \frac{52mV \cdot 0.7}{I_{L(PEAK)}} \leq \frac{52mV \cdot 0.7}{\left( \frac{41}{8} \cdot 16 \cdot 0.02 \right) \cdot (1 + 0.25)}$$

$$\leq \frac{52mV \cdot 0.7}{2.05} \leq 17.7 \text{ m}\Omega$$

## APPLICATIONS INFORMATION

The power rating of RS should be selected to exceed the I<sup>2</sup>R losses in the resistor. The peak inductor current should be recalculated for the chosen RS value to ensure the chosen inductor will not saturate.

### Power MOSFET: Overcurrent and Hiccup Mode

For severe external faults which may cause the external MOSFET to reach currents greater than the peak current defined by RS and the 52mV sense pin threshold described above, the LT3754 has an overcurrent comparator which triggers soft start and turns off the MOSFET driver for currents exceeding,

$$I_{D(OVERCURRENT)} = \frac{100\text{mV}}{RS}$$

In this fault mode the LT3754 only allows MOSFET turn on for approximately 100ns every 2ms. This hiccup mode significantly reduces the power rating required for the MOSFET.

### Soft-Start

To limit inductor inrush current and output voltage during start-up or recovery from a fault condition, the LT3754 provides a soft-start function. The LT3754 when entering these faults will discharge an internal soft-start node and prevent switching at the GATE pin for any of the following faults: V<sub>IN</sub>, SHDN/UVLO or INTV<sub>CC</sub> voltages too low or MOSFET current too high (see the timing diagram in Figure 2). When exiting these faults the LT3754 ramps up an internal soft-start node at approximately 0.5V/ms to control V<sub>C</sub> pin voltage rise and hence control MOSFET switch current rise. In addition the soft start period gradually ramps up switching frequency from approximately 33% to 100% of full scale.

The conditions required to exit all faults and allow a soft-start ramp of the V<sub>C</sub> pin are listed in Figure 2. An added feature of the LT3754 is that it waits for the first PWM pin active high (minimum 200ns pulse width) before it allows the soft-start of V<sub>C</sub> pin to begin. This feature ensures that

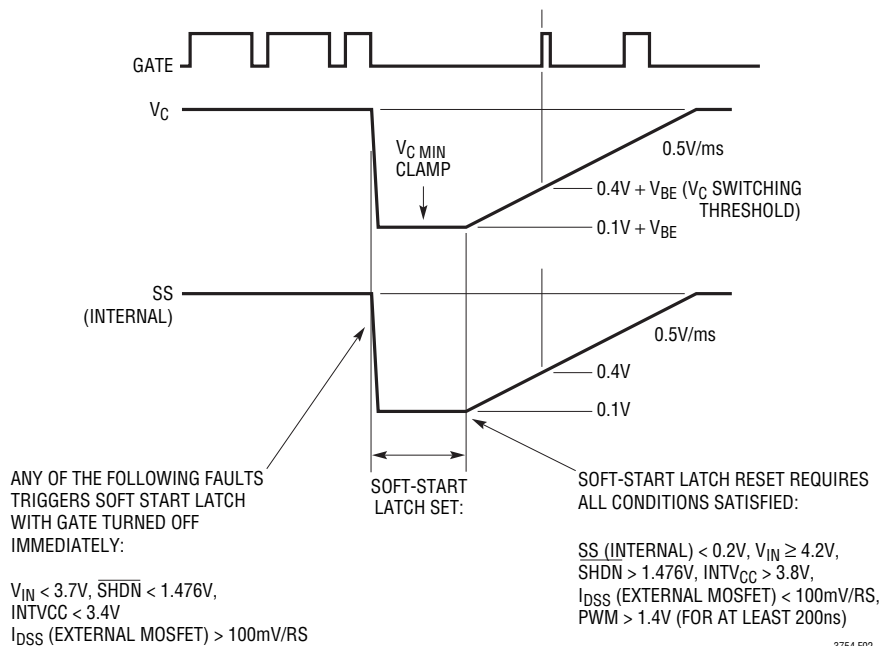

Figure 2. LT3754 Fault Detection and Soft Start Timing for V<sub>C</sub> Pin and Internal SS Node



## APPLICATIONS INFORMATION

during start-up of the LT3754 the soft-start ramp has not timed out before PWM is asserted high. Without this ‘wait for PWM high’ feature, systems which apply PWM after  $V_{IN}$  and  $\overline{SHDN}/UVLO$  are valid, can potentially turn on without soft-start and experience high inductor currents during wake up of the converter’s output voltage. It is important to note that when PWM subsequently goes low, the soft-start ramp is not held at its present voltage but continues to ramp upwards. If the soft-start ramp voltage was held every time PWM goes low, this would cause very slow start-up of LED displays for applications using very high PWM Dimming ratios.

### Shutdown and Programming Undervoltage Lockout

The LT3754 has an accurate 1.476V shutdown threshold at the  $\overline{SHDN}/UVLO$  pin. This threshold can be used in conjunction with a resistor divider from the system input supply to define an accurate undervoltage lockout (UVLO) threshold for the system (Figure 3). An internal hysteresis current at the  $\overline{SHDN}/UVLO$  pin allows programming of hysteresis voltage for this UVLO threshold. Just before part turn on, an internal 2.4 $\mu$ A flows from the  $\overline{SHDN}/UVLO$

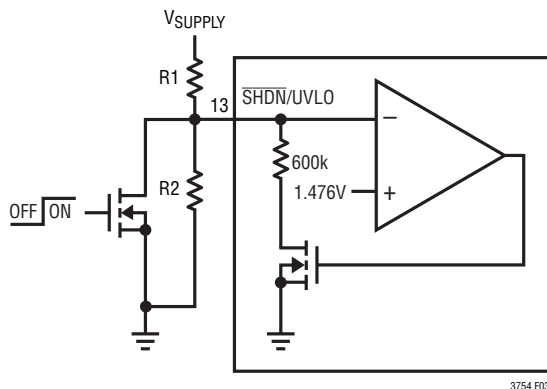

Figure 3. Programming Undervoltage Lockout (UVLO) with Hysteresis

pin. After part turn on, 0 $\mu$ A flows from the  $\overline{SHDN}/UVLO$  pin. Calculation of the turn on/off thresholds for a system input supply using the LT3754  $\overline{SHDN}/UVLO$  pin can be made as follows :

$$V_{\text{SUPPLY OFF}} = 1.476 \left( 1 + \frac{R1}{R2} \right)$$

$$V_{\text{SUPPLY ON}} = V_{\text{SUPPLY OFF}} + (2.4\mu\text{A} \cdot R1)$$

An open drain transistor can be added to the resistor divider network at the  $\overline{SHDN}/UVLO$  pin to independently control the turn off of the LT3754.

### Programming Switching Frequency

The switching frequency of the LT3754 boost converter can be programmed between 100kHz and 1MHz using a single resistor ( $R_T$ ) connected from the  $R_T$  pin to ground (Figure 4). Connect the  $R_T$  resistor as close as possible to the  $R_T$  pin to minimize noise pick up and stray capacitance (see ‘Circuit Layout Considerations’ in the Applications Information section). Table 5 shows the typical  $R_T$  values required for a range of frequencies.

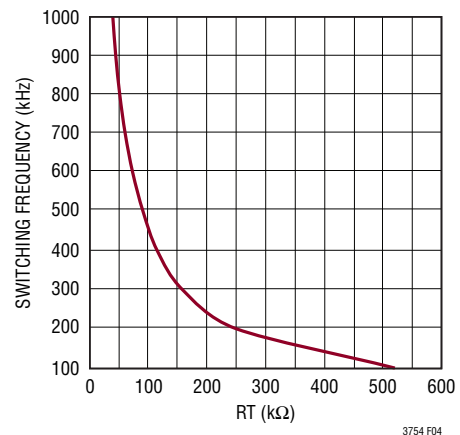

Figure 4. Switching Frequency vs  $R_T$

## APPLICATIONS INFORMATION

Selecting the optimum frequency depends on several factors. Higher frequency allows reduction of inductor size but efficiency drops due to higher switching losses. Lower frequency allows higher operational duty cycles to drive a larger number of LEDs per string from a low input supply but require larger magnetics. In each application the switching frequency can be tailored to provide the optimum solution.

**Table 5. Switching Frequency vs RT (1% Resistors)**

SWITCHING FREQUENCY (kHz)	RT (kΩ)
100	523
200	249
300	158
400	115
500	90.9
600	73.2
700	60.4
800	51.1
900	44.2
1000	39.2

### Duty Cycle Considerations

When designing the LT3754 LED driver for a given application, the duty cycle requirements should be considered and compared to the minimum/maximum achievable duty cycles for the LT3754 GATE pin. If required, the LT3754 switching frequency can be programmed to a lower value to meet the duty cycle requirements. In general, the minimum/maximum GATE duty cycles required for a particular application are given by:

$$\text{MIN Duty Cycle} = \text{GATE Minimum On-Time} \cdot \text{Switching Frequency } f_{\text{OSC}}$$

$$\text{MAX Duty Cycle} = 1 - (\text{GATE Minimum Off-Time} \cdot \text{Switching Frequency } f_{\text{OSC}})$$

The typical values for LT3754 GATE pin minimum on- and off-times versus temperature are shown in the Typical Performance Characteristics. The range of GATE pin minimum on-time and off-times are given in the electrical specifications.

**Table 6. LED Current vs R<sub>ISET</sub> (1% Resistors)**

LED CURRENT PER CHANNEL (mA)	R <sub>ISET</sub> (kΩ)
10	29.4
20	14.7
30	9.76
40	7.32
50	5.76

An extra 50ns should be added to these tested timings to account for errors in the rise/fall times of the GATE and DRAIN of the external MOSFET and the d.c. resistance of the external MOSFET and inductor.

### Synchronizing to an external clock

The SYNC pin allows the LT3754 oscillator to be synchronized to an external clock. The SYNC pin can be driven from a logic level output, requiring less than 0.6V for a logic level low and greater than 2.2V for a logic level high. SYNC pin high or low periods should exist for at least 100ns. If unused, the SYNC pin should be tied to ground. To avoid loss of slope compensation during synchronization, the free running oscillator frequency ( $f_{\text{OSC}}$ ) of the LT3754 should be programmed to 80% of the external clock frequency.

### Programming LED Current

The current source to ground at each LED pin is programmed using a single resistor R<sub>ISET</sub> connected from the I<sub>SET</sub> pin to ground according to the following equation:

$$I(\text{LED}_X) \approx \frac{295}{R_{\text{ISET}}} (\text{A}) (\text{CTRL} > 1.1\text{V})$$

See Table 6 for resistor values and corresponding programmed LED.



## APPLICATIONS INFORMATION

### Analog Dimming

The LT3754 allows for LED dimming (brightness reduction) by analog dimming or by PWM dimming. Analog dimming uses the CTRL pin voltage below 1V to reduce LED brightness by reducing LED current. For CTRL pin voltage below 1V, the current in each LED pin is given by:

$$I(\text{LED}_X) \approx \text{CTRL} \cdot \frac{295}{R_{\text{ISET}}} \quad (0.04 < \text{CTRL} < 1\text{V})$$

For CTRL pin voltages below 40mV (greater than 25:1 dimming) the LED current will approach zero current. The CTRL pin voltage can be derived from a resistor divider from V<sub>REF</sub> pin to ground or generated from an external source. If analog dimming is not required, the pin can be directly connected to the V<sub>REF</sub> pin. The only drawback of analog dimming is that reducing LED current to reduce the brightness of the LED also changes the perceived color of the LED.

### PWM Dimming

Many applications require an accurate control of the brightness of the LED(s). In addition, being able to maintain a constant color over the entire dimming range can be just as critical. For constant color LED dimming the LT3754 provides a PWM pin and special internal circuitry to achieve up to a 3000:1 wide PWM dimming range. This is achieved by operating the LED at its programmed current and then controlling the on-time of that LED current. The duty cycle of the PWM pin controls the on-time of each LED pin current source (Figure 5). For maximum PWM dimming ratios (low PWM duty cycles) it is important to be able to turn LED currents on/off as quickly as possible. For PWM low, the LT3754 turns off the boost converter, turns off all LED channel currents and disconnects the V<sub>C</sub> pin and internal V<sub>OUT</sub> resistor divider connected to the OVP error amplifier. This allows the part to quickly return to the last state of operation when the PWM pin is returned high.

Some general guidelines for LED current dimming using the PWM pin (see Figure 5):

1. PWM Dimming Ratio (PDR) = 1/(PWM Duty Cycle) =  $1/T_{\text{ON(PWM)}} \cdot f_{\text{PWM}}$

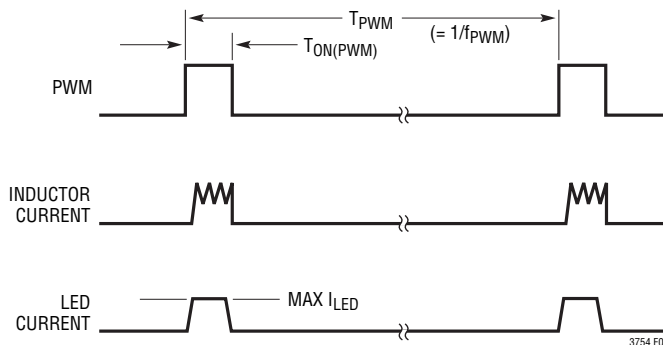

Figure 5. PWM Dimming Waveforms

2. Lower PWM frequency ( $f_{\text{PWM}}$ ) allows higher PWM dimming ratios (typically choose 100Hz to maximize PDR and to avoid visible flicker which can occur for display systems with refresh rates at frequencies below 80Hz)
3. Higher  $f_{\text{OSC}}$  value improves PDR (allows lower  $T_{\text{ON(PWM)}}$ ) but will reduce efficiency and increase internal heating. In general, minimum operational  $T_{\text{ON(PWM)}} = 3 \cdot (1/f_{\text{OSC}})$
4. Lower inductor value improves PDR
5. Higher output capacitor value improves PDR
6. Choose the Schottky diode for the LT3754 boost converter for minimum reverse leakage current.
7. Start-Up  
 LT3754 V<sub>OUT</sub> start-up requires SHDN/UVLO and PWM pins to be asserted from off to on and the PWM on-time to be above a minimum value. The lowest PWM on-time allowed for fault detection is  $\approx 3.2\mu\text{s}$ . The lowest PWM on-time allowed for reaching V<sub>OUT</sub> regulation is typically 3.2 $\mu\text{s}$  but might be greater depending on external circuit parameters. Once LED current is in regulation, PWM on-time can be further reduced depending on external component selection.
8. V<sub>OUT</sub> Collapse  
 If during normal operation V<sub>OUT</sub> collapses due to a fault or because PWM on-time is too low, a restart is required (see 'Start-Up' in item 7).

## APPLICATIONS INFORMATION

### Programming LED Current Derating (Breakpoint and Slope) versus LED Ambient Temperature (CTRL Pin)

LED data sheets provide curves of maximum allowed LED current versus ambient temperature to warn against damaging of the LED (Figure 6). The LT3754 LED driver improves the utilization and reliability of the LED(s) by allowing the programming of an LED current derating curve versus the ambient temperature of the LED(s). Without the ability to back off LED currents as temperature increases, many LED drivers are limited to driving the LED(s) at 50% or less of their maximum rated currents. This limitation requires more LEDs to obtain the intended brightness for the application. The LT3754 allows the LED(s) to be programmed for maximum allowable current while still protecting the LED(s) from excessive currents at high temperature. The temperature breakpoint and the slope of LED current versus ambient temperature can be programmed using a simple resistor network shown in Figure 7.

This is achieved by programming a voltage at the CTRL pin with a negative temperature coefficient using a resistor divider with temperature dependent resistance (Figures 7 and 8). A variety of resistor networks and NTC resistors

with different temperature coefficients can be used to achieve the desired CTRL pin voltage behavior versus temperature. The current derating curve in Figure 6 uses the resistor network shown in option C of Figure 7.

Table 7 shows a list of NTC resistor manufacturers/distributors. There are several other manufacturers available and the chosen supplier should be contacted for more detailed information. To use an NTC resistor to monitor the ambient temperature of the LED(s) it should be placed as close as possible to the LED(s). Since the temperature dependency of an NTC resistor can be non-linear over a wide range of temperatures it is important to obtain a resistor's exact values over temperature from the manufacturer. Hand calculations of CTRL voltage can then be performed at each given temperature and the resulting CTRL voltage plotted versus temperature.

**Table 7. NTC Resistor Manufacturers**

MANUFACTURER	WEB
Murata Electronics North America	<a href="http://www.murata.com">www.murata.com</a>
TDK Corporation	<a href="http://www.tdk.com">www.tdk.com</a>
Digi-key	<a href="http://www.digikey.com">www.digikey.com</a>

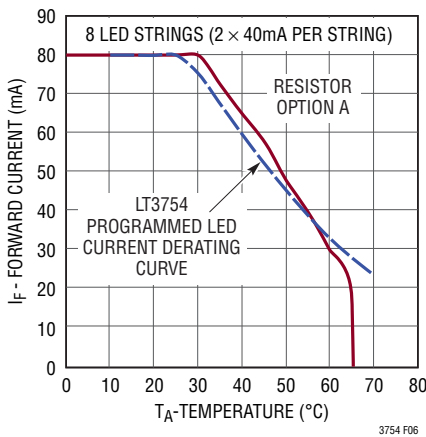

**Figure 6. LED Current Derating vs LED Ambient Temperature**

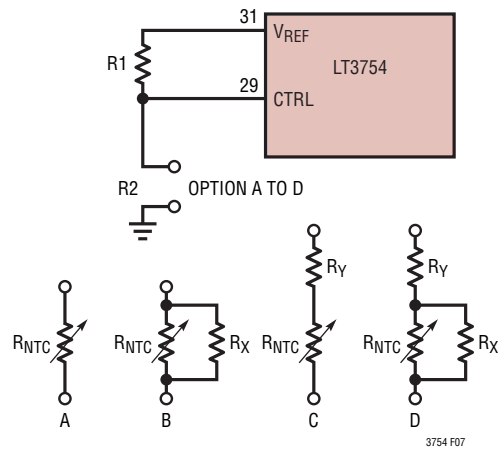

**Figure 7. Programming LED Current Derating Curve vs Ambient Temperature ( $R_{NTC}$  Located on LED PCB)**

## APPLICATIONS INFORMATION

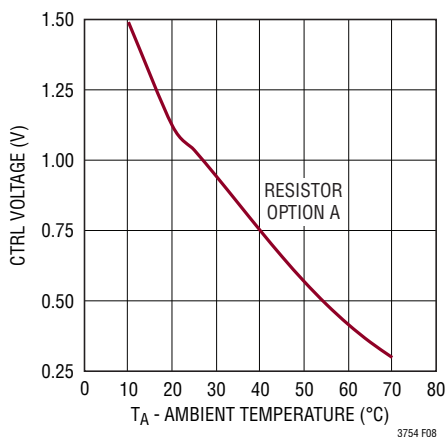

Figure 8. Programmed CTRL Voltage vs Temperature

If calculation of CTRL voltage at various temperatures gives a downward slope that is too strong, alternative resistor networks can be chosen (B,C,D in Figure 7) which use temperature independent resistance to reduce the effects of the NTC resistor over temperature. Murata Electronics provides a selection of NTC resistors with complete data over a wide range of temperatures. In addition, a software tool is available which allows the user to select from different resistor networks and NTC resistor values and then simulate the exact output voltage curve (CTRL pin behavior) over temperature. Referred to on the website as the 'Murata Chip NTC Thermistor Output Voltage Simulator', users can log onto [www.murata.com/designlib](http://www.murata.com/designlib) and download the software followed by instructions for creating an output voltage 'V<sub>OUT</sub>' (LT3754 CTRL pin voltage) from a specified V<sub>CC</sub> supply (LT3754 V<sub>REF</sub> pin voltage). At any time during selection of circuit parameters the user can access data on the chosen NTC resistor by clicking on the link to the Murata catalog. For a detailed example of hand calculations using an NTC type resistor divider to program CTRL pin voltage, read the LT3478 LED driver data sheet section *Programming LED Current Derating vs Temperature* under Applications Information.

### Using the T<sub>SET</sub> Pin for Thermal Protection

The LT3754 contains a special programmable thermal regulation loop that limits the internal junction temperature of the part. Since the LT3754 topology consists of a single boost controller with sixteen linear current sources, any LED string voltage mismatch will cause additional power to be dissipated in the package. This topology provides excellent current matching between LED strings and allows a single power stage to drive a large number of LEDs, but at the price of additional power dissipation inside the part (which means a higher junction temperature). Being able to limit the maximum junction temperature allows the benefits of this topology to be fully realized. This thermal regulation feature provides important protection at high ambient temperatures, and allows a given application to be optimized for typical, not worst-case, ambient temperatures with the assurance that the LT3754 will automatically protect itself and the LED strings under worst-case conditions.

The operation of the thermal loop is simple. As the ambient temperature increases, so does the internal junction temperature of the part. Once the programmed maximum junction temperature is reached, the LT3754 begins to linearly reduce the LED current, as needed, to try and maintain this temperature. This can only be achieved when the ambient temperature stays below the desired maximum junction temperature. If the ambient temperature continues to rise past the programmed maximum junction temperature, the LEDs current will be reduced to approximately 5% of the full LED current.

While this feature is intended to directly protect the LT3754, it can also be used to derate the LED current at high temperatures. Since there is a direct relationship between the LED temperature and LT3754 junction temperature, the TSET function also provides some LED current derating at high temperatures.

## APPLICATIONS INFORMATION

Two external resistors program the maximum IC junction temperature using a resistor divider from the  $V_{REF}$  pin, as shown in Figure 9. Choose the ratio of R1 and R2 for the desired junction temperature. Figure 10 shows the relationship of  $T_{SET}$  voltage to junction temperature, and Table 8 shows commonly used values for R1 and R2.

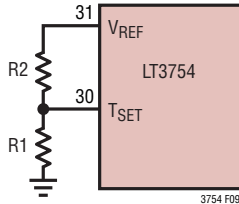

Figure 9. Programming the  $T_{SET}$  Pin

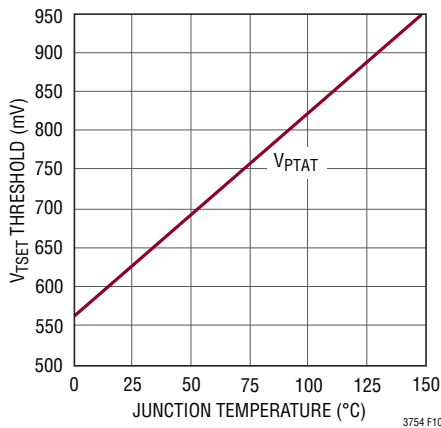

Figure 10. Programing the  $T_{SET}$  Pin Threshold

Table 7. Resistor Values to Program Maximum IC Junction Temperature ( $V_{REF}$  (Typical) = 1.485V)

$T_J$ (°C)	R1 (k)	R2 (k)	$T_{SET}$ (V)
100	24.9	20	0.824
115	28.0	20	0.866
130	30.9	20	0.902

### Programming Overvoltage Protection (OVP) level

The LT3754 LED driver provides optimum protection to the LEDs and the external MOSFET by providing a programmable maximum regulated output voltage limit using the  $OVP_{SET}$  pin. The Overvoltage Protection (OVP) level is programmed as:

$$OVP(\text{MAXIMUM REGULATED } V_{OUT}) = 57 \cdot OVP_{SET}$$

If every LED string fails open or the multiple string LED display becomes disconnected the LT3754 LED driver loop regulates to the programmed OVP level. The OVP level should be programmed to a level high enough to regulate the LED strings but low enough to prevent damage to the power switch and to minimize the voltage across the LED pins upon reconnection of the LED strings. Recommended OVP level is given by:

$$OVP(\text{RECOMMENDED}) = 1.2 \cdot ((N \cdot V_F) + 1V)$$

where:

$N$  = number of LEDs in each string,

$V_F$  = maximum LED forward voltage drop

and the scaling factor of 1.2 accounts for variation in the generation of OVP from  $OVP_{SET}$  pin voltage and start-up logic requirements.

Example: For a converter operating with 10 LEDs per string at a maximum forward voltage of 4V per LED, the OVP level should be programmed to:

$$OVP(\text{RECOMMENDED}) = 1.2 \cdot ((10 \cdot 4) + 1V) = 49.2V$$

$$\text{For } OVP = 49.2V, OVP_{SET} = \frac{49.2}{57} = 0.863V$$

The  $OVP_{SET}$  pin voltage can be generated using a resistor divider from the REF pin.

## APPLICATIONS INFORMATION

### LED Open Circuit and PWM Dimming Ratios

The LT3754 monitors each LED pin voltage to determine if the LED string has an open fault (LED pin voltage < 0.5V). If an open LED fault occurs, the FAULT flag is pulled low. To avoid false detection of faults during the initial converter start-up when  $V_{OUT}$  is low, the LT3754 ignores low LED pin voltages until  $V_{OUT}$  reaches 90% of its maximum allowed OVP level. Once this condition is met, the LT3754 monitors all LED pins for open LED faults. To avoid false detection of faults during PWM dimming edges (where LED pins can possibly ring and trip fault detection levels) the LT3754 only monitors/updates fault conditions during PWM high (and only after a blank duration of 2 $\mu$ s following each PWM rising edge).

### LED Short Circuit

A short circuit fault between the positive terminal of an LED string ( $V_{OUT}$ ) and the negative terminal of the LED string (LEDx pin) causes the channel to be disabled in order to protect the internal current source. A resistive short is allowed as long as  $(V_{OUT} - V_{LEDx}) < 6V$ . During the short, however, cable inductance can cause the LED pin voltage to overshoot past  $V_{OUT}$  voltage. To avoid LED pin voltage exceeding its absolute maximum rated voltage, a diode may be required to clamp the LED pin. The anode of a 1N4148WS diode should be connected to the LED pin and the cathode of the diode connected to the  $V_{OUT}$  pin. Keep the traces as short as possible. A Schottky diode should not be used due to high reverse bias leakage currents.

### Loop Compensation

Be sure to check the stability of the loop with the LEDs connected (LED regulation loop) and disconnected (Overvoltage Protection (OVP) regulation loop). Various application circuits are shown in the data sheet which cover a range of  $V_{IN}$ ,  $V_{OUT}$ ,  $f_{OSC}$ , output power and inductor current ripple values. For application requirements which deviate from the circuits shown in the data sheet be sure to check the stability of the final application over the full

$V_{IN}$  range, LED current range (if analog dimming) and temperature range. Be aware that if the  $V_C$  pin components represent the dominant pole for the converter loop and they have been adjusted to achieve stability, the  $V_C$  pin might move more slowly during load transient conditions such as an all-LEDs-open fault. A slower moving  $V_C$  pin will add to  $V_{OUT}$  overshoot during an all-LEDs-open fault. An alternative compensation approach is to place the dominant pole of the converter loop at the output. This requires an increased output capacitor value but will allow a much reduced  $V_C$  capacitor. The combination will allow  $V_C$  to move more quickly and  $V_{OUT}$  to move more slowly resulting in less overshoot during an all-LEDs-open fault.

### Thermal Considerations

The internal power dissipation of the LT3754 comes from 3 main sources:  $V_{IN}$  quiescent current ( $I_Q$  total),  $V_{IN}$  current for GATE switching ( $I_{GATE}$ ) and the LT3754 LED current sources. Since the maximum operational  $V_{IN}$  voltage is 40V, care should be taken when selecting the switching frequency and type of external power MOSFET since the current required from  $V_{IN}$  for GATE switching is given by,

$$I_{GATE} = f_{OSC} \cdot Q_g$$

where  $Q_g$  is the gate charge (at  $V_{GS} = INTV_{CC}$ ) specified for the MOSFET and  $f_{OSC}$  is the programmed switching frequency for the LT3754. A low  $Q_g$  MOSFET should always be used when operating the LT3754 from high  $V_{IN}$  voltages. The internal junction temperature of the LT3754 can be estimated as:

$$T_J = T_A + [V_{IN} \cdot (I_{QTOTAL} + (f_{OSC} \cdot Q_g)) + (16 \cdot I(LED_x) \cdot 1.1V)] \cdot \theta_{JA}$$

where,  $T_A$  is the ambient temperature for the LT3754  $I_{QTOTAL}$  represents the  $V_{IN}$  quiescent current for the LT3754 (not switching, PWM = 1.5V and CTRL = 0.1V) - illustrated in the Typical Characteristics Graphs - plus the base currents of active channels (typically  $16 \cdot I(LED)/75$ ).  $\theta_{JA}$  is the thermal resistance of the package (34°C/W for the 5mm × 5mm QFN package).



## APPLICATIONS INFORMATION

Example : For a 12W LED driver application requiring 16 strings of 10 LEDs each driven with 20mA,  $V_{IN} = 24V$ ,  $f_{OSC} = 1MHz$ ,  $Q_g$  (at 7V  $V_{GS}$ ) = 15nC,  $I(LED_X) = 20mA$ , and an 85°C ambient temperature for the LT3754 IC, the LT3754 junction temperature can be approximated as:

$$\begin{aligned} T_J &= 85^\circ C + [24 \cdot (9.5mA + (16 \cdot 20mA/75) + (1MHz \cdot 15nC)) + (16 \cdot 20mA \cdot 1.1V)] \cdot 34 \\ &= 85^\circ C + [(24 \cdot 28.8mA) + (320mA \cdot 1.1V)] \cdot 34 \\ &= 85^\circ C + (0.691W + 0.35W) \cdot 34 \\ &= 85^\circ C + 35^\circ C \\ T_J &= 120^\circ C \end{aligned}$$

The exposed pad on the bottom of the package must be soldered to the ground plane. The ground plane should be connected to an internal copper ground plane with vias placed directly under the package to spread out the heat generated by the LT3754.

### Circuit Layout Considerations

As with all switching regulators, careful attention must be given to PCB layout and component placement to achieve optimal thermal, electrical and noise performance. The exposed pad of the LT3754 is the only ground connection for the IC. The exposed pad should be soldered to a

continuous copper ground plane underneath the device to reduce die temperature and maximize the power capability of the IC. An analog ground is down bonded to the exposed pad near the RT and  $V_C$  pins.  $I_{SET}$ ,  $R_T$  and  $V_C$  components should be connected to an area of ground copper near these pins. The  $OVP_{SET}$  track should be kept away from fast moving signals and not loaded with an external capacitor. GATE pin turn off currents escape through a downbond to the exposed pad near the GATE pin. This area of copper should be the power ground (PGND) connection for the inductor input capacitor,  $INTV_{CC}$  capacitor and output capacitor. A separate bypass capacitor for the  $V_{IN}$  pin of the IC may be required close the  $V_{IN}$  pin and connected to the copper area associated with analog ground. To minimize MOSFET peak current sensing errors the sense resistor (RS) should have Kelvin connections to the SENSE pin and the power ground copper area near the pin. The MOSFET drain rise and fall times are designed to be as short as possible for maximum efficiency. To reduce the effects of both radiated and conducted noise, the area of the copper trace for the MOSFET drain should be kept as small as possible. Use a ground plane under the switching regulator to minimize interplane coupling. The Schottky diode and output capacitor should be placed as close as possible to the drain node to minimize this high switching frequency path.

TYPICAL APPLICATIONS

92% Efficient, 36W LED Driver, 1MHz Boost, 16 Strings, 50mA per String

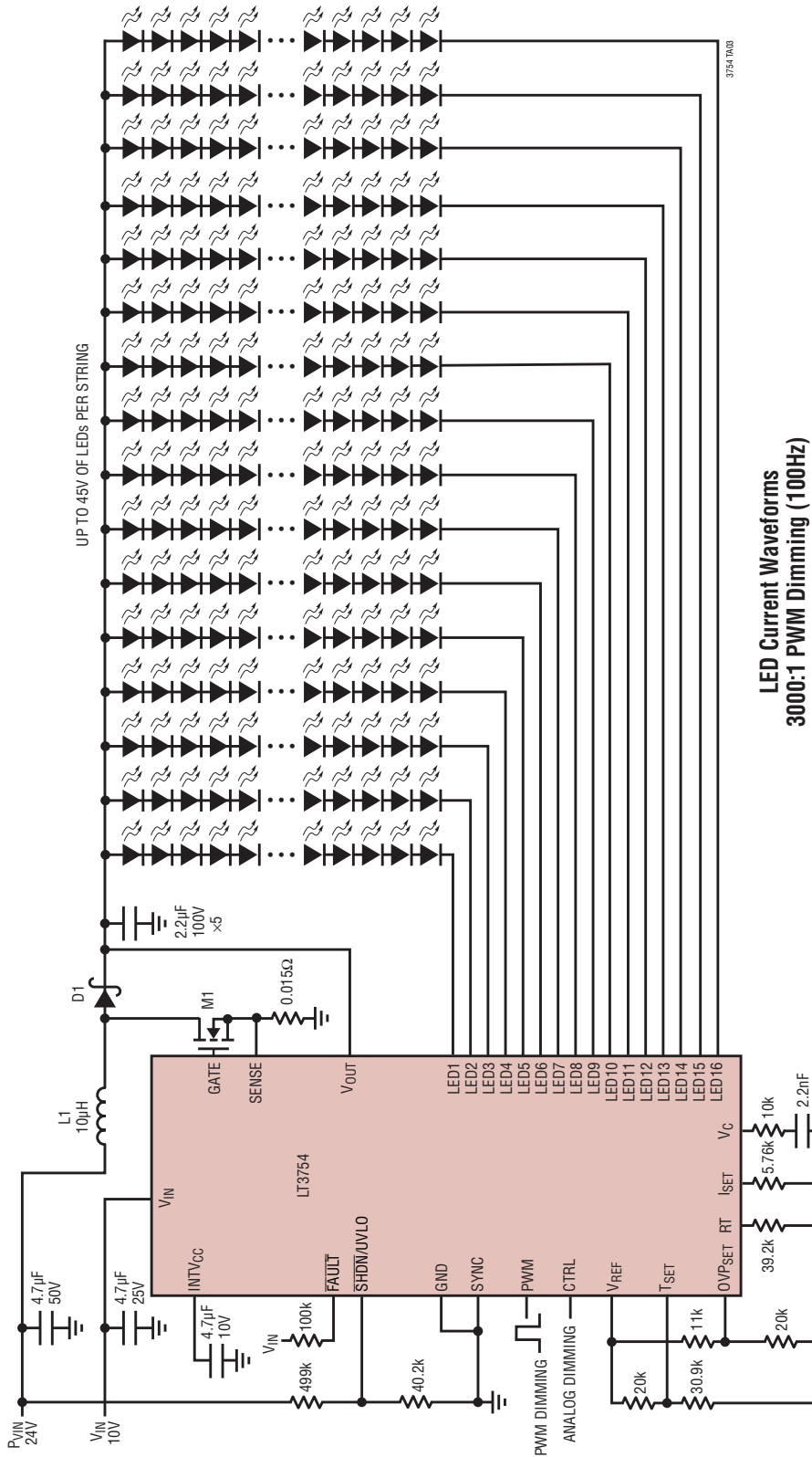

LED Current Waveforms  
3000:1 PWM Dimming (100Hz)

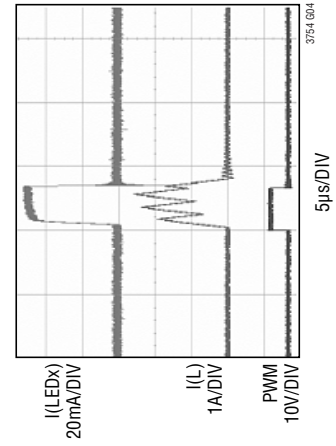

- L1: SUMIDA CDRH038
- M1: VISHAY SILICONIX SI7850DP
- D1: DIODES, INC. PDS360

TYPICAL APPLICATIONS

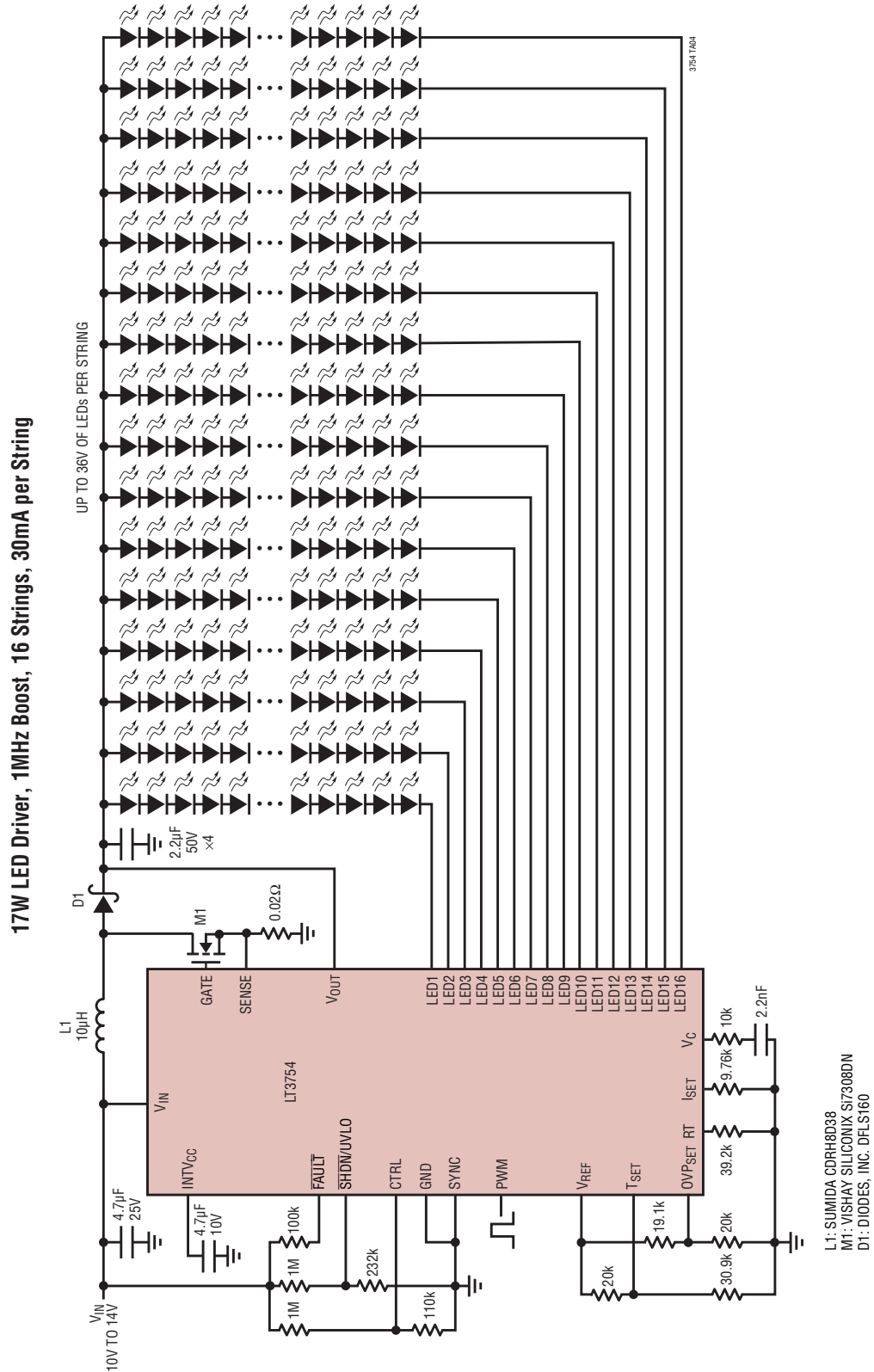



# TYPICAL APPLICATIONS

31W LED Driver, 400kHz Boost, 3 Strings, 250mA per String

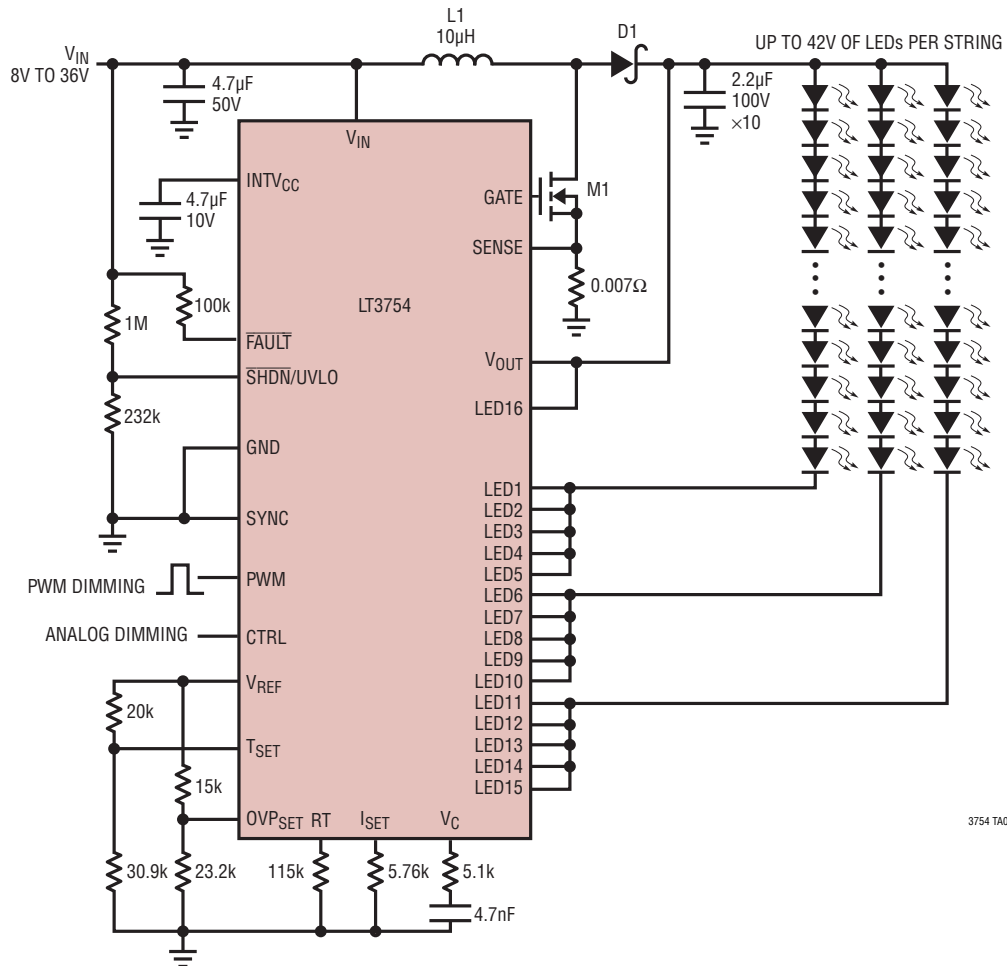

L1: COOPER BUSSMANN HC9-100-R  
 M1: VISHAY SILICONIX Si7850DP  
 D1: DIODES, INC. PDS560

3754 TA06

## TYPICAL APPLICATIONS

14W LED Driver, 700kHz Boost, 4 Strings, 80mA per String

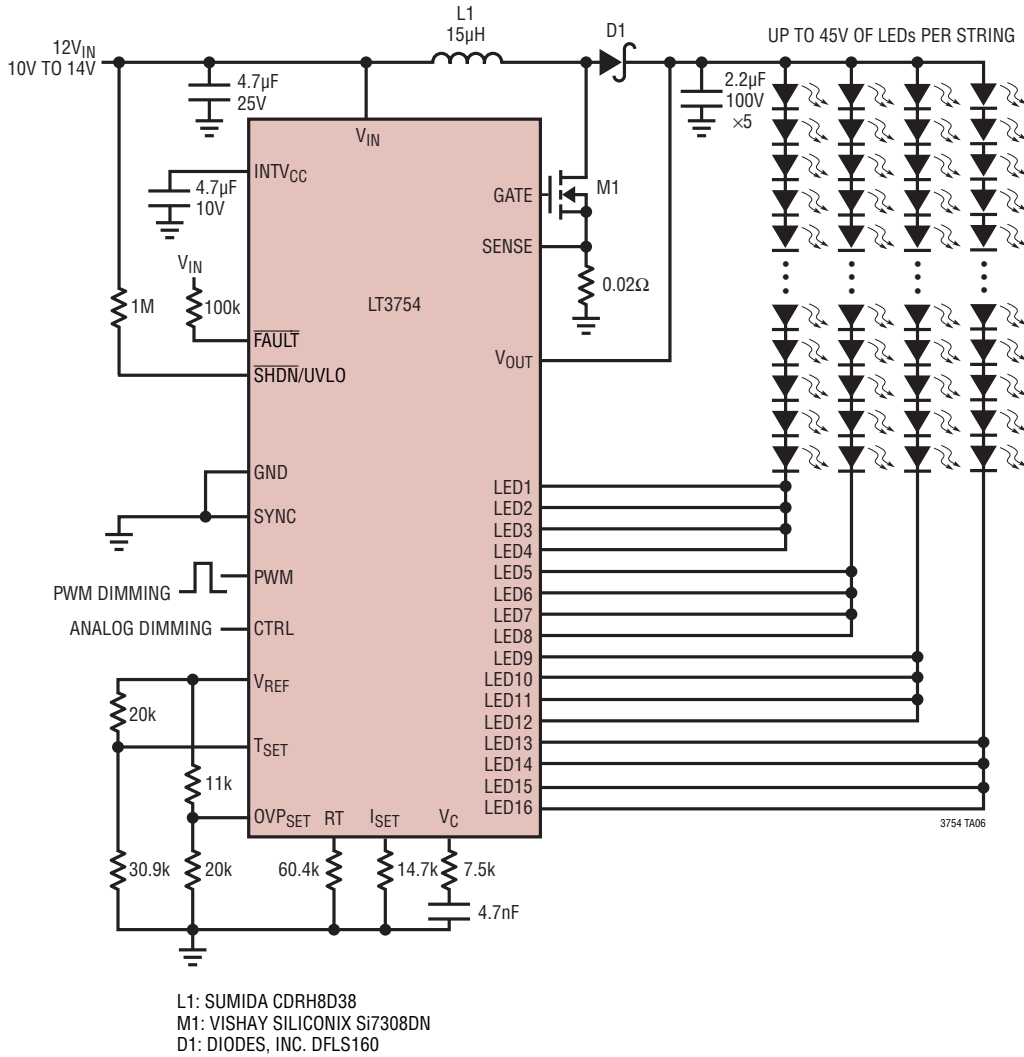

3754 TA06

TYPICAL APPLICATIONS

13W LED Driver, 1MHz SEPIC, 16 Strings, 50mA per String (Survives  $V_{OUT}$  Short to GND)

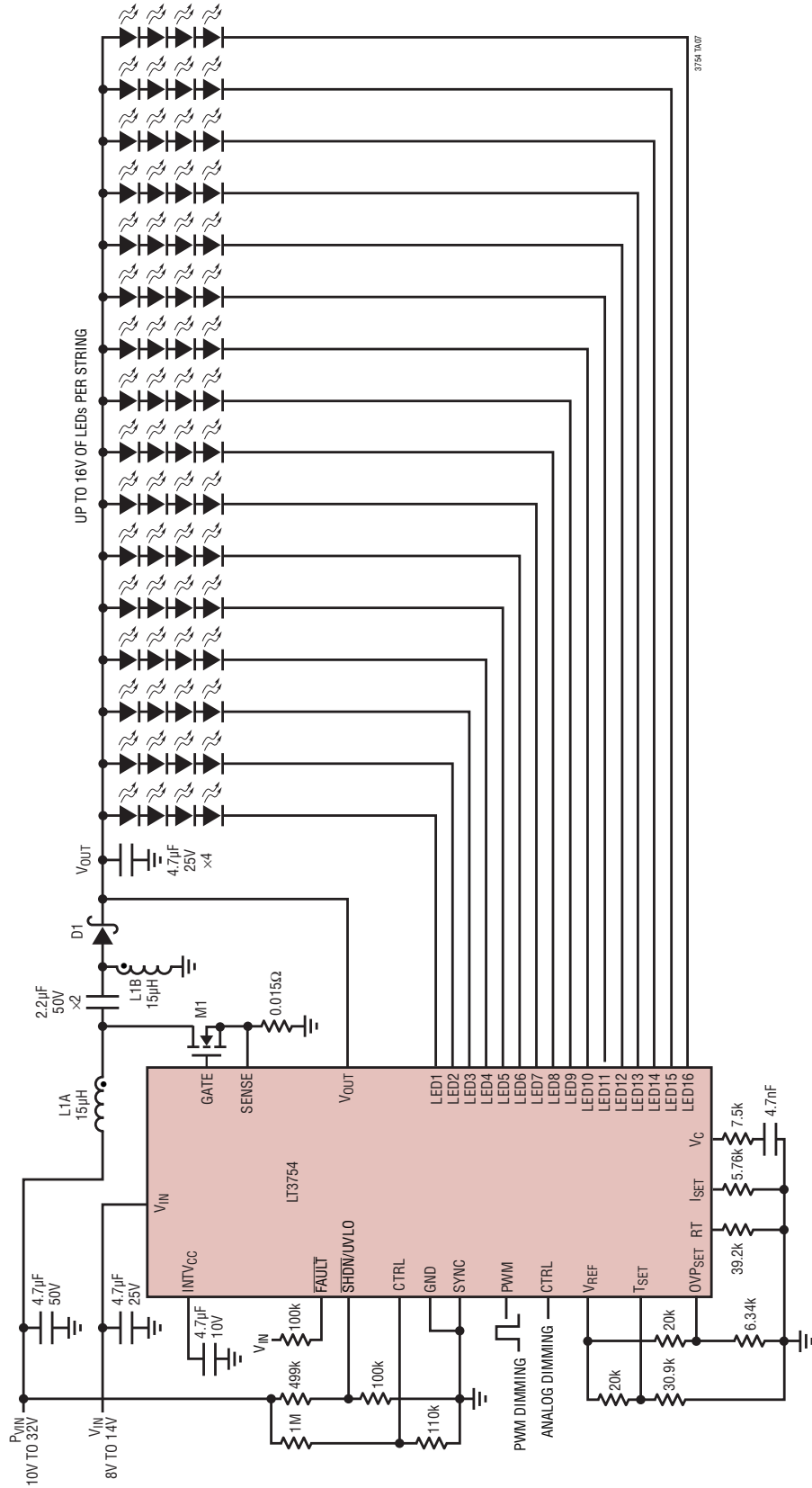

L1A: L1B: 15µH COUPLED INDUCTOR DRQ125  
 M1: VISHAY SILICONIX SI7850DP  
 D1: DIODES, INC. PDS560

3754 TA07

# PACKAGE DESCRIPTION

Please refer to <http://www.linear.com/designtools/packaging/> for the most recent package drawings.

**UH Package**  
**32-Lead Plastic QFN (5mm × 5mm)**  
 (Reference LTC DWG # 05-08-1693 Rev D)

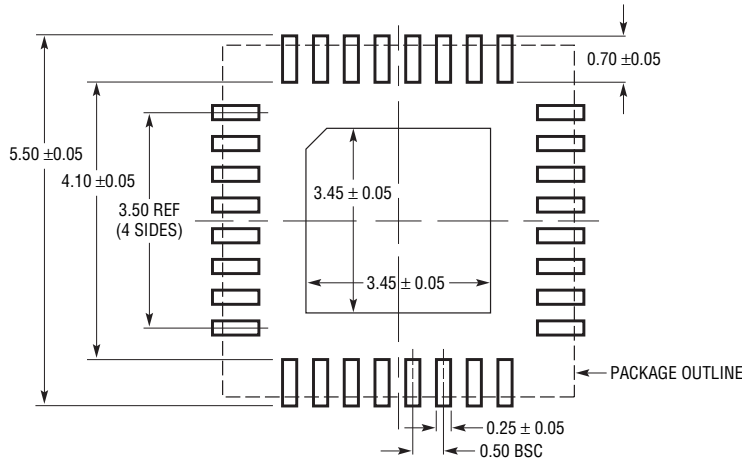

RECOMMENDED SOLDER PAD LAYOUT  
 APPLY SOLDER MASK TO AREAS THAT ARE NOT SOLDERED

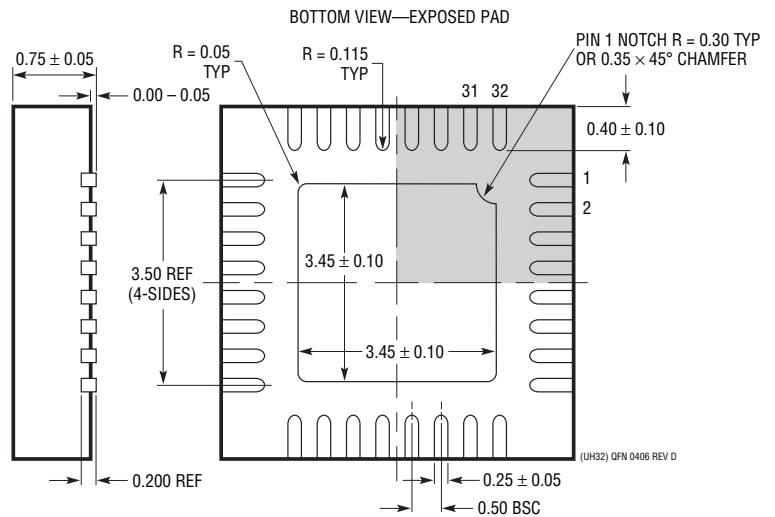
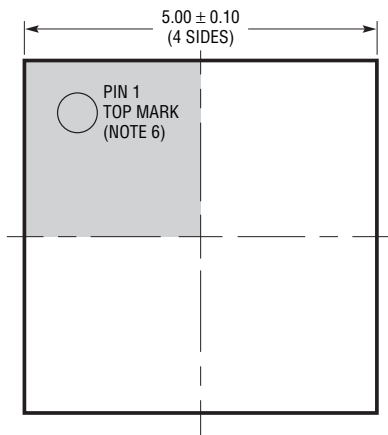

- NOTE:
1. DRAWING PROPOSED TO BE A JEDEC PACKAGE OUTLINE  
 M0-220 VARIATION WHHD-(X) (TO BE APPROVED)
  2. DRAWING NOT TO SCALE
  3. ALL DIMENSIONS ARE IN MILLIMETERS
  4. DIMENSIONS OF EXPOSED PAD ON BOTTOM OF PACKAGE DO NOT INCLUDE  
 MOLD FLASH. MOLD FLASH, IF PRESENT, SHALL NOT EXCEED 0.20mm ON ANY SIDE
  5. EXPOSED PAD SHALL BE SOLDER PLATED
  6. SHADED AREA IS ONLY A REFERENCE FOR PIN 1 LOCATION  
 ON THE TOP AND BOTTOM OF PACKAGE

## REVISION HISTORY

REV	DATE	DESCRIPTION	PAGE NUMBER
A	07/10	Updated $V_{REF}$ pin labelling	1, 2, 18, 23, 24, 25, 26
		Corrected electrical spec limit ( $V_{IN(MAX)} = INTV_{CC}$ abs max)	3
		Updated Electrical Characteristics conditions	3, 4, 5
		Updated Typical Performance Characteristics (label)	7
		Updated Pin Functions	8
		Updated Operations text	10
		Updated equation	13
		Corrected text errors	14, 15, 20
		Updated PWM Dimming Guidelines (added items 7, 8)	17
		Updated Figure 6	18
		Updated LED Short Circuit text	21
		Updated Typical Applications (output capacitor formatting)	23, 24, 25
		Added new Typical Application (SEPIC)	27
		Updated Related Parts	30
B	01/11	Revised $\overline{FAULT}$ pin description in Pin Functions section	8
C	10/11	Updated Features section.	1
		Updated "Programming LED Current Derating (Breakpoint and Slope) versus LED Ambient Temperature (CTRL Pin)" section.	18