

FEATURES

- 60 μ V Maximum Offset Voltage
- 300pA Maximum Input Bias Current
- 135 μ A Supply Current per Amplifier
- Rail-to-Rail Output Swing
- 120dB Minimum Voltage Gain, $V_S = \pm 15\text{V}$
- 0.8 $\mu\text{V}/^\circ\text{C}$ Maximum V_{OS} Drift
- 14nV/ $\sqrt{\text{Hz}}$ Input Noise Voltage
- 2.7V to $\pm 18\text{V}$ Supply Voltage Operation
- Operating Temperature Range: -40°C to 85°C
- Space Saving 3mm \times 3mm DFN Package

APPLICATIONS

- Thermocouple Amplifiers
- Precision Photo Diode Amplifiers
- Instrumentation Amplifiers
- Battery-Powered Precision Systems
- Low Voltage Precision Systems

DESCRIPTION

The LT[®]6011/LT6012 op amps combine low noise and high precision input performance with low power consumption and rail-to-rail output swing.

Input offset voltage is trimmed to less than 60 μV . The low drift and excellent long-term stability guarantee a high accuracy over temperature and time. The 300pA maximum input bias current and 120dB minimum voltage gain further maintain this precision over operating conditions.

The LT6011/LT6012 work on any power supply voltage from 2.7V to 36V and draw only 135 μA of supply current on a 5V supply. The output swings to within 40mV of either supply rail, making the amplifier a good choice for low voltage single supply applications.

The LT6011/LT6012 are specified at 5V and $\pm 15\text{V}$ supplies and from -40°C to 85°C . The LT6011 (dual) is available in SO-8, MS8 and space saving 3mm \times 3mm DFN packages. The LT6012 (quad) is available in SO-14 and 16-pin SSOP packages.

LT, LT, LTC, LTM, Linear Technology and the Linear logo are registered trademarks and SoftSpan is a trademark of Linear Technology Corporation. All other trademarks are the property of their respective owners.

TYPICAL APPLICATION

Low Power Programmable Output Range 16-Bit SoftSpan™ DAC

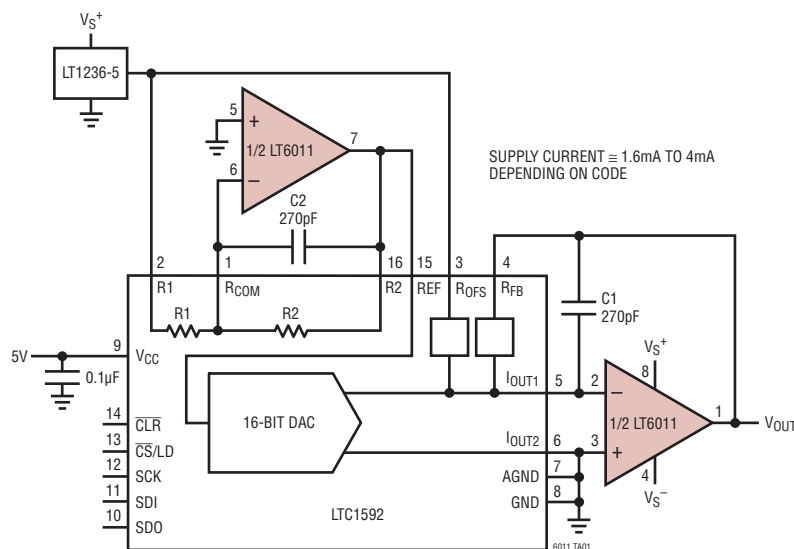

20V Output Step Response

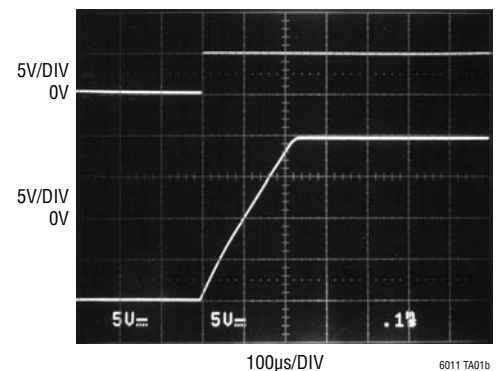

ABSOLUTE MAXIMUM RATINGS (Note 1)

Total Supply Voltage (V^+ to V^-)	40V	Operating Temperature Range (Note 4)....	-40°C to 85°C
Differential Input Voltage (Note 2)	10V	Specified Temperature Range (Note 5)	-40°C to 85°C
Input Voltage.....	V^+ to V^-	Maximum Junction Temperature	150°C
Input Current (Note 2).....	$\pm 10\text{mA}$	Storage Temperature Range	-65°C to 150°C
Output Short-Circuit Duration (Note 3)	Indefinite	Lead Temperature (Soldering, 10 sec).....	300°C

PACKAGE/ORDER INFORMATION

<p style="text-align: center;">TOP VIEW</p> <p style="text-align: center;">DD PACKAGE 8-LEAD (3mm x 3mm) PLASTIC DFN</p> <p style="text-align: center;">$T_{JMAX} = 150^{\circ}\text{C}$, $\theta_{JA} = 43^{\circ}\text{C/W}$ UNDERSIDE METAL CONNECTED TO V^- (PCB CONNECTION OPTIONAL)</p>	<p style="text-align: center;">TOP VIEW</p> <p style="text-align: center;">S8 PACKAGE 8-LEAD PLASTIC SO</p> <p style="text-align: center;">$T_{JMAX} = 150^{\circ}\text{C}$, $\theta_{JA} = 190^{\circ}\text{C/W}$</p>	<p style="text-align: center;">TOP VIEW</p> <p style="text-align: center;">MS8 PACKAGE 8-LEAD PLASTIC MSOP</p> <p style="text-align: center;">$T_{JMAX} = 150^{\circ}\text{C}$, $\theta_{JA} = 220^{\circ}\text{C/W}$</p>
<p style="text-align: center;">TOP VIEW</p> <p style="text-align: center;">S PACKAGE 14-LEAD PLASTIC SO</p> <p style="text-align: center;">$T_{JMAX} = 150^{\circ}\text{C}$, $\theta_{JA} = 110^{\circ}\text{C/W}$</p>	<p style="text-align: center;">TOP VIEW</p> <p style="text-align: center;">GN PACKAGE 16-LEAD PLASTIC SSOP</p> <p style="text-align: center;">$T_{JMAX} = 150^{\circ}\text{C}$, $\theta_{JA} = 135^{\circ}\text{C/W}$</p>	

ORDER INFORMATION

LEAD FREE FINISH	TAPE AND REEL	PART MARKING*	PACKAGE DESCRIPTION	SPECIFIED TEMPERATURE RANGE
LT6011CDD#PBF	LT6011CDD#TRPBF	LACD	8-Lead (3mm × 3mm) Plastic DFN	0°C to 70°C
LT6011IDD#PBF	LT6011IDD#TRPBF	LACD	8-Lead (3mm × 3mm) Plastic DFN	-40°C to 85°C
LT6011ACDD#PBF	LT6011ACDD#TRPBF	LACD	8-Lead (3mm × 3mm) Plastic DFN	0°C to 70°C
LT6011AIDD#PBF	LT6011AIDD#TRPBF	LACD	8-Lead (3mm × 3mm) Plastic DFN	-40°C to 85°C
LT6011CS8#PBF	LT6011CS8#TRPBF	6011	8-Lead Plastic SO	0°C to 70°C
LT6011IS8#PBF	LT6011IS8#TRPBF	6011I	8-Lead Plastic SO	-40°C to 85°C
LT6011ACS8#PBF	LT6011ACS8#TRPBF	6011A	8-Lead Plastic SO	0°C to 70°C
LT6011AIS8#PBF	LT6011AIS8#TRPBF	6011AI	8-Lead Plastic SO	-40°C to 85°C
LT6011CMS8#PBF	LT6011CMS8#TRPBF	LTCGC	8-Lead Plastic MSOP	0°C to 70°C
LT6011IMS8#PBF	LT6011IMS8#TRPBF	LTCGC	8-Lead Plastic MSOP	-40°C to 85°C
LT6012CS#PBF	LT6012CS#TRPBF	LT6012CS	14-Lead Plastic SO	0°C to 70°C
LT6012IS#PBF	LT6012IS#TRPBF	LT6012IS	14-Lead Plastic SO	-40°C to 85°C
LT6012ACS#PBF	LT6012ACS#TRPBF	LT6012ACS	14-Lead Plastic SO	0°C to 70°C
LT6012AIS#PBF	LT6012AIS#TRPBF	LT6012AIS	14-Lead Plastic SO	-40°C to 85°C
LT6012CGN#PBF	LT6012CGN#TRPBF	6012	16-Lead Plastic SSOP	0°C to 70°C
LT6012IGN#PBF	LT6012IGN#TRPBF	6012I	16-Lead Plastic SSOP	-40°C to 85°C
LT6012ACGN#PBF	LT6012ACGN#TRPBF	6012A	16-Lead Plastic SSOP	0°C to 70°C
LT6012AIGN#PBF	LT6012AIGN#TRPBF	6012AI	16-Lead Plastic SSOP	-40°C to 85°C

Consult LTC Marketing for parts specified with wider operating temperature ranges. *The temperature grade is identified by a label on the shipping container.

For more information on lead free part marking, go to: <http://www.linear.com/leadfree/>

For more information on tape and reel specifications, go to: <http://www.linear.com/tapeandreeel/>

LT6011/LT6012

ELECTRICAL CHARACTERISTICS

The ● denotes the specifications which apply over the full operating temperature range, otherwise specifications are at $T_A = 25^\circ\text{C}$. $V_S = 5\text{V}$, 0V ; $V_{\text{CM}} = 2.5\text{V}$; R_L to 0V ; unless otherwise specified. (Note 5)

SYMBOL	PARAMETER	CONDITIONS	MIN	TYP	MAX	UNITS
V_{OS}	Input Offset Voltage (Note 8)	LT6011AS8, LT6012AS $T_A = 0^\circ\text{C}$ to 70°C $T_A = -40^\circ\text{C}$ to 85°C	● ●	20	60 85 110	μV μV μV
		LT6011ADD, LT6012AGN $T_A = 0^\circ\text{C}$ to 70°C $T_A = -40^\circ\text{C}$ to 85°C	● ●	25	85 135 170	μV μV μV
		LT6011S8, LT6012S $T_A = 0^\circ\text{C}$ to 70°C $T_A = -40^\circ\text{C}$ to 85°C	● ●	25	75 100 125	μV μV μV
		LT6011DD, LT6012GN, LT6011MS8 $T_A = 0^\circ\text{C}$ to 70°C $T_A = -40^\circ\text{C}$ to 85°C	● ●	30	125 175 210	μV μV μV
$\Delta V_{\text{OS}}/\Delta T$	Input Offset Voltage Drift (Note 6)	LT6011AS8, LT6011S8, LT6012AS, LT6012S LT6011ADD, LT6011DD, LT6012AGN, LT6012GN, LT6011MS8	● ●	0.2	0.8	$\mu\text{V}/^\circ\text{C}$ $\mu\text{V}/^\circ\text{C}$
				0.2	1.2	$\mu\text{V}/^\circ\text{C}$
I_{OS}	Input Offset Current (Note 8)	LT6011AS8, LT6011ADD, LT6012AS, LT6012AGN $T_A = 0^\circ\text{C}$ to 70°C $T_A = -40^\circ\text{C}$ to 85°C	● ●	20	300 450 600	pA pA pA
		LT6011S8, LT6011DD, LT6012S, LT6012GN, LT6011MS8 $T_A = 0^\circ\text{C}$ to 70°C $T_A = -40^\circ\text{C}$ to 85°C	● ●	150	900 1200 1500	pA pA pA
I_{B}	Input Bias Current (Note 8)	LT6011AS8, LT6011ADD, LT6012AS, LT6012AGN $T_A = 0^\circ\text{C}$ to 70°C $T_A = -40^\circ\text{C}$ to 85°C	● ●	20	± 300 ± 450 ± 600	pA pA pA
		LT6011S8, LT6011DD, LT6012S, LT6012GN, LT6011MS8 $T_A = 0^\circ\text{C}$ to 70°C $T_A = -40^\circ\text{C}$ to 85°C	● ●	150	± 900 ± 1200 ± 1500	pA pA pA
	Input Noise Voltage	0.1Hz to 10Hz		400		$\text{nV}_{\text{P-P}}$
e_{n}	Input Noise Voltage Density	$f = 1\text{kHz}$		14		$\text{nV}/\sqrt{\text{Hz}}$
i_{n}	Input Noise Current Density	$f = 1\text{kHz}$, Unbalanced Source Resistance		0.1		$\text{pA}/\sqrt{\text{Hz}}$
R_{IN}	Input Resistance	Common Mode, $V_{\text{CM}} = 1\text{V}$ to 3.8V Differential		10	120	$\text{G}\Omega$
				20		$\text{M}\Omega$
C_{IN}	Input Capacitance			4		pF
V_{CM}	Input Voltage Range (Positive)	Guaranteed by CMRR	●	3.8	4	V
	Input Voltage Range (Negative)	Guaranteed by CMRR	●	0.7	1	V
CMRR	Common Mode Rejection Ratio	$V_{\text{CM}} = 1\text{V}$ to 3.8V	●	107	135	dB
	Minimum Supply Voltage	Guaranteed by PSRR	●	2.4	2.7	V
PSRR	Power Supply Rejection Ratio	$V_S = 2.7\text{V}$ to 36V , $V_{\text{CM}} = 1/2V_S$	●	112	135	dB
A_{VOL}	Large-Signal Voltage Gain	$R_L = 10\text{k}$, $V_{\text{OUT}} = 1\text{V}$ to 4V	●	300	2000	V/mV
		$R_L = 2\text{k}$, $V_{\text{OUT}} = 1\text{V}$ to 4V	●	250	2000	V/mV
	Channel Separation	$V_{\text{OUT}} = 1\text{V}$ to 4V	●	110	140	dB

ELECTRICAL CHARACTERISTICS The ● denotes the specifications which apply over the full operating temperature range, otherwise specifications are at $T_A = 25^\circ\text{C}$. $V_S = 5\text{V}$, 0V ; $V_{CM} = 2.5\text{V}$; R_L to 0V ; unless otherwise specified. (Note 5)

SYMBOL	PARAMETER	CONDITIONS	MIN	TYP	MAX	UNITS
V_{OUT}	Maximum Output Swing (Positive, Referred to V^+)	No Load, 50mV Overdrive	●	35	55 65	mV mV
		$I_{SOURCE} = 1\text{mA}$, 50mV Overdrive	●	120	170 220	mV mV
	Maximum Output Swing (Negative, Referred to 0V)	No Load, 50mV Overdrive	●	40	55 65	mV mV
		$I_{SINK} = 1\text{mA}$, 50mV Overdrive	●	150	225 275	mV mV
I_{SC}	Output Short-Circuit Current (Note 3)	$V_{OUT} = 0\text{V}$, 1V Overdrive, Source	●	10 4	14	mA mA
		$V_{OUT} = 5\text{V}$, -1V Overdrive, Sink	●	10 4	21	mA mA
SR	Slew Rate	$A_V = -10$, $R_F = 50\text{k}$, $R_G = 5\text{k}$ $T_A = 0^\circ\text{C}$ to 70°C $T_A = -40^\circ\text{C}$ to 85°C	● ● ●	0.06 0.05 0.04	0.09	V/ μs V/ μs V/ μs
GBW	Gain Bandwidth Product	$f = 10\text{kHz}$	●	250 225	330	kHz kHz
t_s	Settling Time	$A_V = -1$, 0.01%, $V_{OUT} = 1.5\text{V}$ to 3.5V		45		μs
t_r, t_f	Rise Time, Fall Time	$A_V = 1$, 10% to 90%, 0.1V Step		1		μs
ΔV_{OS}	Offset Voltage Match (Note 7)	LT6011AS8, LT6012AS $T_A = 0^\circ\text{C}$ to 70°C $T_A = -40^\circ\text{C}$ to 85°C	● ●	50	120 170 220	μV μV μV
		LT6011ADD, LT6012AGN $T_A = 0^\circ\text{C}$ to 70°C $T_A = -40^\circ\text{C}$ to 85°C	● ●	50	170 270 340	μV μV μV
		LT6011S8, LT6012S $T_A = 0^\circ\text{C}$ to 70°C $T_A = -40^\circ\text{C}$ to 85°C	● ●	50	150 200 250	μV μV μV
		LT6011DD, LT6012GN, LT6011MS8 $T_A = 0^\circ\text{C}$ to 70°C $T_A = -40^\circ\text{C}$ to 85°C	● ●	60	250 350 420	μV μV μV
ΔI_B	Input Bias Current Match (Note 7)	LT6011AS8, LT6011ADD, LT6012AS, LT6012AGN $T_A = 0^\circ\text{C}$ to 70°C $T_A = -40^\circ\text{C}$ to 85°C	● ●	50	600 900 1200	pA pA pA
		LT6011S8, LT6011DD, LT6012S, LT6012GN, LT6011MS8 $T_A = 0^\circ\text{C}$ to 70°C $T_A = -40^\circ\text{C}$ to 85°C	● ●		1800 2400 3000	pA pA pA
ΔCMRR	Common Mode Rejection Ratio Match (Note 7)		●	101	135	dB
ΔPSRR	Power Supply Rejection Ratio Match (Note 7)		●	106	135	dB
I_S	Supply Current	per Amplifier		135	150	μA
		$T_A = 0^\circ\text{C}$ to 70°C	●		190	μA
		$T_A = -40^\circ\text{C}$ to 85°C	●		210	μA

LT6011/LT6012

ELECTRICAL CHARACTERISTICS

The ● denotes the specifications which apply over the full operating temperature range, otherwise specifications are at $T_A = 25^\circ\text{C}$. $V_S = \pm 15\text{V}$, $V_{CM} = 0\text{V}$; R_L to 0V ; unless otherwise specified. (Note 5)

SYMBOL	PARAMETER	CONDITIONS	MIN	TYP	MAX	UNITS
V_{OS}	Input Offset Voltage (Note 8)	LT6011AS8, LT6012AS $T_A = 0^\circ\text{C to } 70^\circ\text{C}$ $T_A = -40^\circ\text{C to } 85^\circ\text{C}$	●	30	135	μV
			●		160	μV
			●		185	μV
		LT6011ADD, LT6012AGN $T_A = 0^\circ\text{C to } 70^\circ\text{C}$ $T_A = -40^\circ\text{C to } 85^\circ\text{C}$	●	35	160	μV
		●		210	μV	
		●		225	μV	
V_{OS}	Input Offset Voltage (Note 8)	LT6011S8, LT6012S $T_A = 0^\circ\text{C to } 70^\circ\text{C}$ $T_A = -40^\circ\text{C to } 85^\circ\text{C}$	●	35	150	μV
			●		175	μV
			●		200	μV
		LT6011DD, LT6012GN, LT6011MS8 $T_A = 0^\circ\text{C to } 70^\circ\text{C}$ $T_A = -40^\circ\text{C to } 85^\circ\text{C}$	●	40	200	μV
		●		250	μV	
		●		275	μV	
$\Delta V_{OS}/\Delta T$	Input Offset Voltage Drift (Note 6)	LT6011AS8, LT6011S8, LT6012AS, LT6012S	●	0.2	0.8	$\mu\text{V}/^\circ\text{C}$
		LT6011ADD, LT6011DD, LT6012AGN, LT6012GN, LT6011MS8	●	0.2	1.3	$\mu\text{V}/^\circ\text{C}$
I_{OS}	Input Offset Current (Note 8)	LT6011AS8, LT6011ADD, LT6012AS, LT6012AGN $T_A = 0^\circ\text{C to } 70^\circ\text{C}$ $T_A = -40^\circ\text{C to } 85^\circ\text{C}$	●	20	300	pA
			●		450	pA
			●		600	pA
		LT6011S8, LT6011DD, LT6012S, LT6012GN, LT6011MS8 $T_A = 0^\circ\text{C to } 70^\circ\text{C}$ $T_A = -40^\circ\text{C to } 85^\circ\text{C}$	●	150	900	pA
		●		1200	pA	
		●		1500	pA	
I_B	Input Bias Current (Note 8)	LT6011AS8, LT6011ADD, LT6012AS, LT6012AGN $T_A = 0^\circ\text{C to } 70^\circ\text{C}$ $T_A = -40^\circ\text{C to } 85^\circ\text{C}$	●	20	± 300	pA
			●		± 450	pA
			●		± 600	pA
		LT6011S8, LT6011DD, LT6012S, LT6012GN, LT6011MS8 $T_A = 0^\circ\text{C to } 70^\circ\text{C}$ $T_A = -40^\circ\text{C to } 85^\circ\text{C}$	●	150	± 900	pA
		●		± 1200	pA	
		●		± 1500	pA	
	Input Noise Voltage	0.1Hz to 10Hz		400		$\text{nV}_{\text{P-P}}$
e_n	Input Noise Voltage Density	$f = 1\text{kHz}$		13		$\text{nV}/\sqrt{\text{Hz}}$
i_n	Input Noise Current Density	$f = 1\text{kHz}$, Unbalanced Source Resistance		0.1		$\text{pA}/\sqrt{\text{Hz}}$
R_{IN}	Input Resistance	Common Mode, $V_{CM} = \pm 13.5\text{V}$		50	400	$\text{G}\Omega$
		Differential			20	$\text{M}\Omega$
C_{IN}	Input Capacitance			4		pF
V_{CM}	Input Voltage Range	Guaranteed by CMRR	●	± 13.5	± 14	V
CMRR	Common Mode Rejection Ratio	$V_{CM} = -13.5\text{V to } 13.5\text{V}$	●	115	135	dB
			●	112	135	dB
	Minimum Supply Voltage	Guaranteed by PSRR	●	± 1.2	± 1.35	V
PSRR	Power Supply Rejection Ratio	$V_S = \pm 1.35\text{V to } \pm 18\text{V}$	●	112	135	dB
A_{VOL}	Large-Signal Voltage Gain	$R_L = 10\text{k}$, $V_{OUT} = -13.5\text{V to } 13.5\text{V}$	●	1000	2000	V/mV
			●	600		V/mV
		$R_L = 5\text{k}$, $V_{OUT} = -13.5\text{V to } 13.5\text{V}$	●	500	1500	V/mV
			●	300		V/mV
	Channel Separation	$V_{OUT} = -13.5\text{V to } 13.5\text{V}$	●	120	140	dB
V_{OUT}	Maximum Output Swing (Positive, Referred to V^+)	No Load, 50mV Overdrive	●	45	80	mV
			●		100	mV
	$I_{SOURCE} = 1\text{mA}$, 50mV Overdrive	●	140	195	mV	
		●		240	mV	
Maximum Output Swing (Negative, Referred to V^-)	No Load, 50mV Overdrive	●	45	80	mV	
		●		100	mV	
	$I_{SINK} = 1\text{mA}$, 50mV Overdrive	●	150	250	mV	
		●		300	mV	

60112fc

ELECTRICAL CHARACTERISTICS The ● denotes the specifications which apply over the full operating temperature range, otherwise specifications are at $T_A = 25^\circ\text{C}$. $V_S = \pm 15\text{V}$, $V_{CM} = 0\text{V}$; R_L to 0V ; unless otherwise specified. (Note 5)

SYMBOL	PARAMETER	CONDITIONS	MIN	TYP	MAX	UNITS
I_{SC}	Output Short-Circuit Current (Note 3)	$V_{OUT} = 0\text{V}$, 1V Overdrive (Source)	● 10	15		mA
		$V_{OUT} = 0\text{V}$, -1V Overdrive (Sink)	● 5			mA
SR	Slew Rate	$A_V = -10$, $R_F = 50\text{k}$, $R_G = 5\text{k}$	● 0.08	0.11		V/ μs
		$T_A = 0^\circ\text{C}$ to 70°C	● 0.07			V/ μs
		$T_A = -40^\circ\text{C}$ to 85°C	● 0.05			V/ μs
GBW	Gain Bandwidth Product	$f = 10\text{kHz}$	● 275	350		kHz
t_s	Settling Time	$A_V = -1$, 0.01%, $V_{OUT} = 0\text{V}$ to 10V		85		μs
t_r , t_f	Rise Time, Fall Time	$A_V = 1$, 10% to 90%, 0.1V Step		1		μs
ΔV_{OS}	Offset Voltage Match (Note 7)	LT6011AS8, LT6012AS	●	50	270	μV
		$T_A = 0^\circ\text{C}$ to 70°C	●		320	μV
		$T_A = -40^\circ\text{C}$ to 85°C	●		370	μV
		LT6011ADD, LT6012AGN	●	50	320	μV
		$T_A = 0^\circ\text{C}$ to 70°C	●		420	μV
$T_A = -40^\circ\text{C}$ to 85°C	●		450	μV		
ΔI_B	Input Bias Current Match (Note 7)	LT6011S8, LT6012S	●	70	300	μV
		$T_A = 0^\circ\text{C}$ to 70°C	●		350	μV
		$T_A = -40^\circ\text{C}$ to 85°C	●		400	μV
ΔI_B	Input Bias Current Match (Note 7)	LT6011DD, LT6012GN, LT6011MS8	●	80	400	μV
		$T_A = 0^\circ\text{C}$ to 70°C	●		500	μV
		$T_A = -40^\circ\text{C}$ to 85°C	●		550	μV
		LT6011AS8, LT6011ADD, LT6012AS, LT6012AGN	●	50	600	pA
$T_A = 0^\circ\text{C}$ to 70°C	●		900	pA		
$T_A = -40^\circ\text{C}$ to 85°C	●		1200	pA		
ΔI_B	Input Bias Current Match (Note 7)	LT6011S8, LT6011DD, LT6012S, LT6012GN, LT6011MS8	●		1800	pA
		$T_A = 0^\circ\text{C}$ to 70°C	●		2400	pA
		$T_A = -40^\circ\text{C}$ to 85°C	●		3000	pA
ΔCMRR	Common Mode Rejection Ratio Match (Note 7)		● 109	135		dB
ΔPSRR	Power Supply Rejection Ratio Match (Note 7)		● 106	135		dB
I_S	Supply Current	per Amplifier	●	260	330	μA
		$T_A = 0^\circ\text{C}$ to 70°C	●		380	μA
		$T_A = -40^\circ\text{C}$ to 85°C	●		400	μA

Note 1: Stresses beyond those listed under Absolute Maximum Ratings may cause permanent damage to the device. Exposure to any Absolute Maximum Rating condition for extended periods may affect device reliability and lifetime.

Note 2: The inputs are protected by back-to-back diodes and internal series resistors. If the differential input voltage exceeds 10V, the input current must be limited to less than 10mA.

Note 3: A heat sink may be required to keep the junction temperature below absolute maximum ratings.

Note 4: Both the LT6011C/LT6012C and LT6011I/LT6012I are guaranteed functional over the operating temperature range of -40°C to 85°C .

Note 5: The LT6011C/LT6012C are guaranteed to meet the specified performance from 0°C to 70°C and is designed, characterized and expected to meet specified performance from -40°C to 85°C but is not tested or QA sampled at these temperatures. The LT6011I/LT6012I are guaranteed to meet specified performance from -40°C to 85°C .

Note 6: This parameter is not 100% tested.

Note 7: Matching parameters are the difference between any two amplifiers. ΔCMRR and ΔPSRR are defined as follows: (1) CMRR and PSRR are measured in $\mu\text{V/V}$ for the individual amplifiers. (2) The difference between matching amplifiers is calculated in $\mu\text{V/V}$. (3) The result is converted to dB.

Note 8: The specifications for V_{OS} , I_B , and I_{OS} depend on the grade and on the package. The following table clarifies the notations.

	STANDARD GRADE	A GRADE
S8 Package	LT6011S8	LT6011AS8
DFN Package	LT6011DD	LT6011ADD
S14 Package	LT6012S	LT6012AS
GN16 Package	LT6012GN	LT6012AGN
MS8 Package	LT6011MS8	N/A

TYPICAL PERFORMANCE CHARACTERISTICS

Distribution of Input Offset Voltage

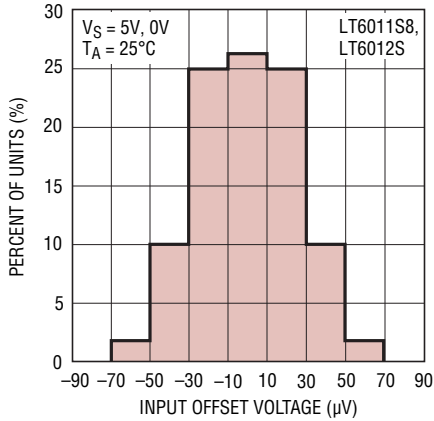

Input Offset Voltage vs Temperature

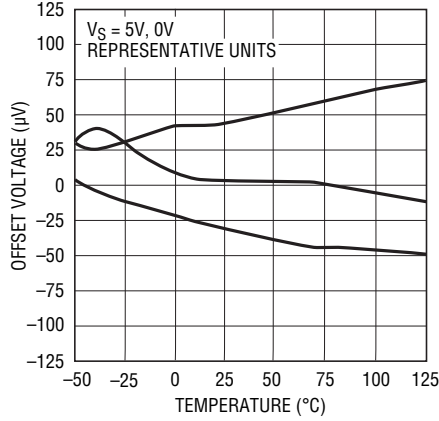

Offset Voltage vs Input Common Mode Voltage

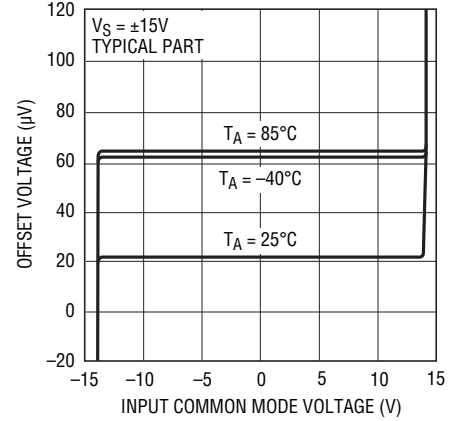

Distribution of Input Bias Current

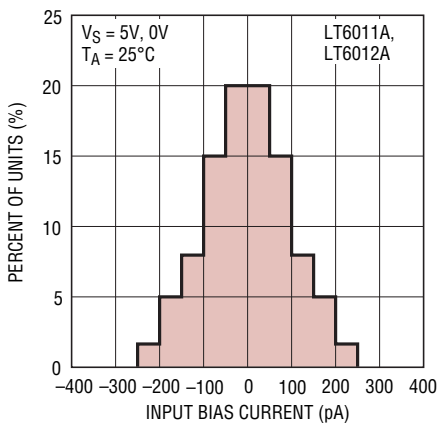

Input Bias Current vs Temperature

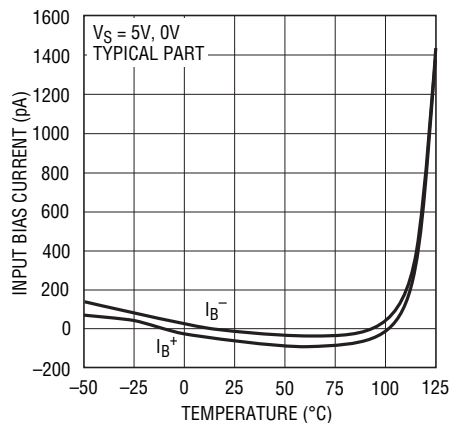

Input Bias Current vs Input Common Mode Voltage

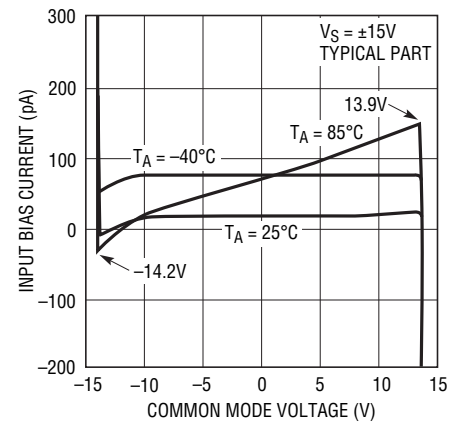

e_n , i_n vs Frequency

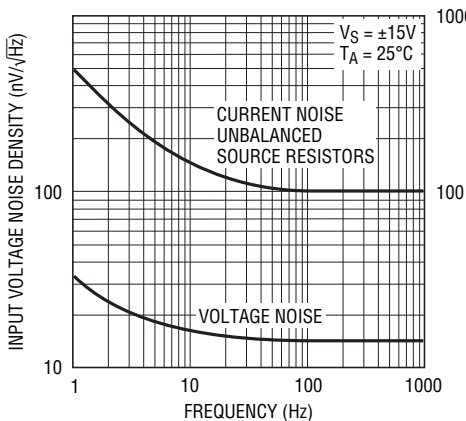

Total Input Noise vs Source Resistance

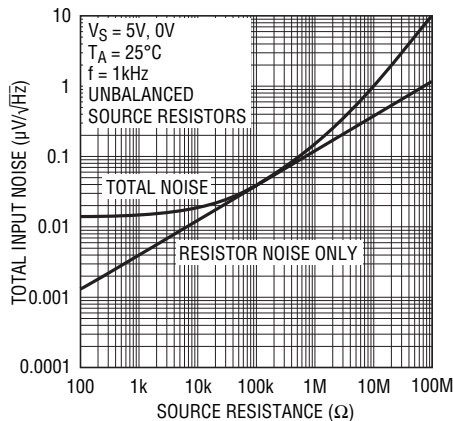

0.1Hz to 10Hz Noise

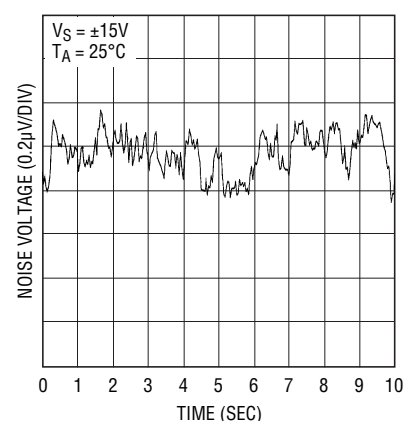

TYPICAL PERFORMANCE CHARACTERISTICS

0.01Hz to 1Hz Noise

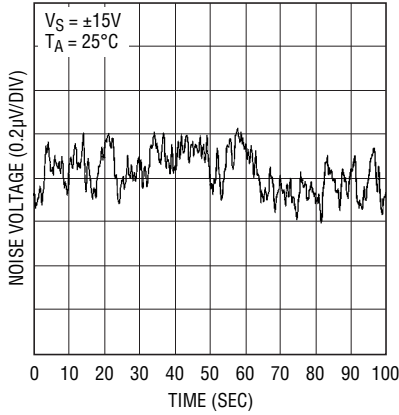

6011 G10

Output Voltage Swing vs Temperature

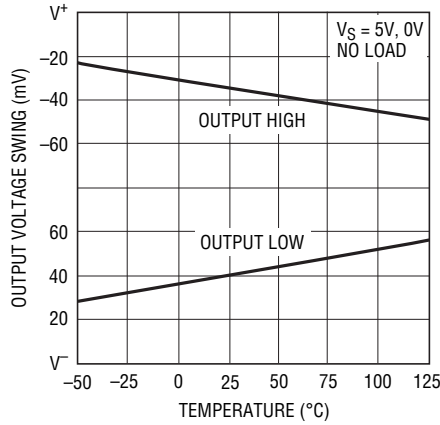

6011 G11

Output Saturation Voltage vs Load Current (Output High)

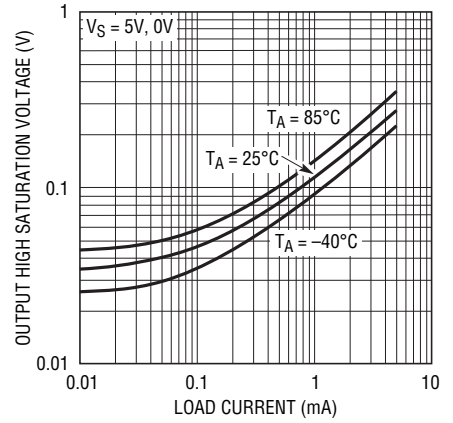

6011 G12

Output Saturation Voltage vs Load Current (Output Low)

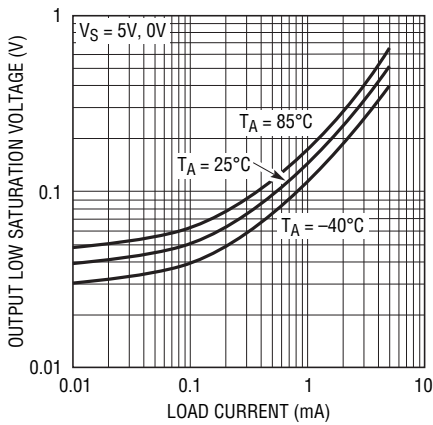

6011 G13

Supply Current vs Supply Voltage

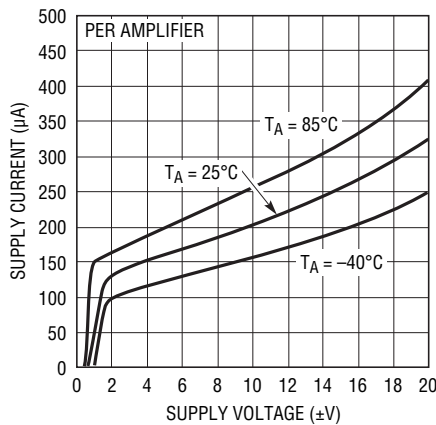

6011 G14

Warm-Up Drift

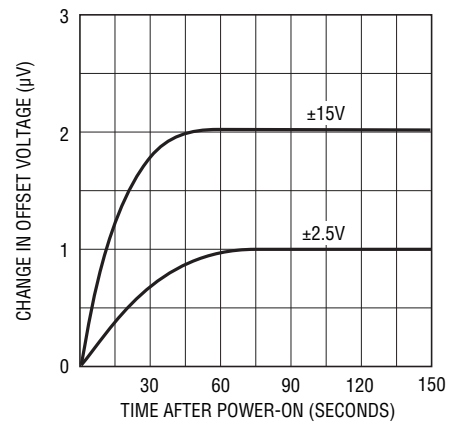

6011 G15

THD + Noise vs Frequency

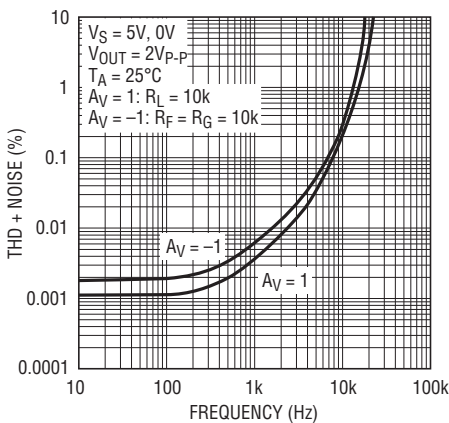

6011 G16

THD + Noise vs Frequency

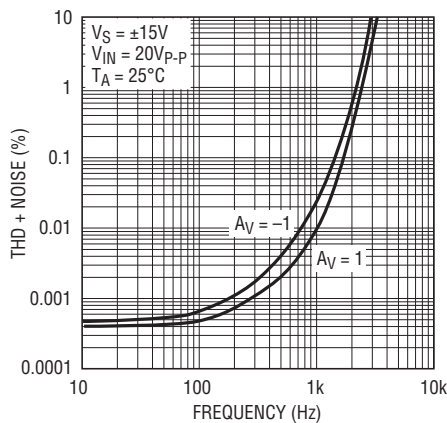

6011 G17

Settling Time vs Output Step

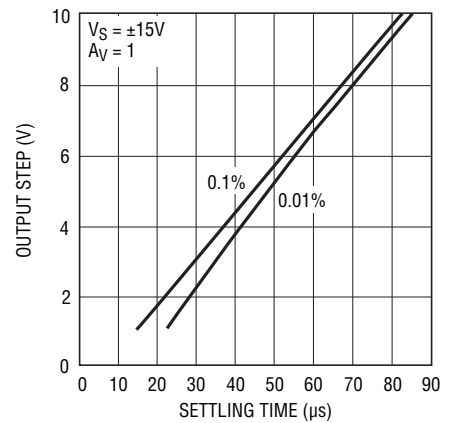

6011 G18

TYPICAL PERFORMANCE CHARACTERISTICS

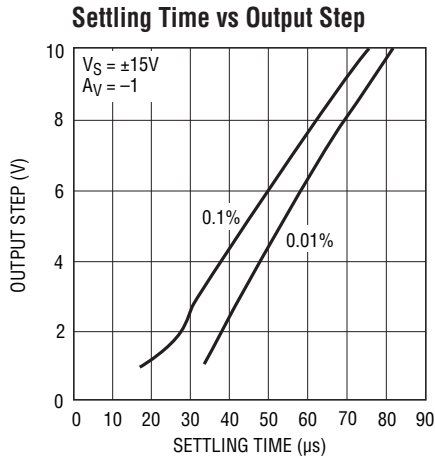

6011 G19

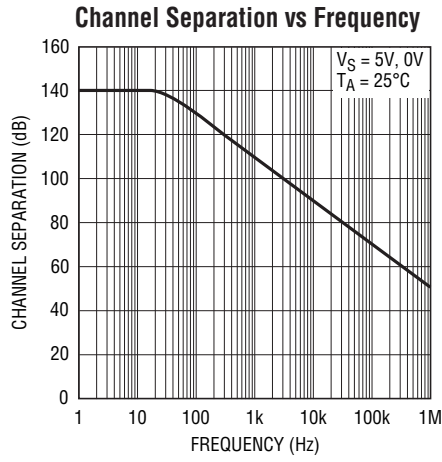

6011 G20

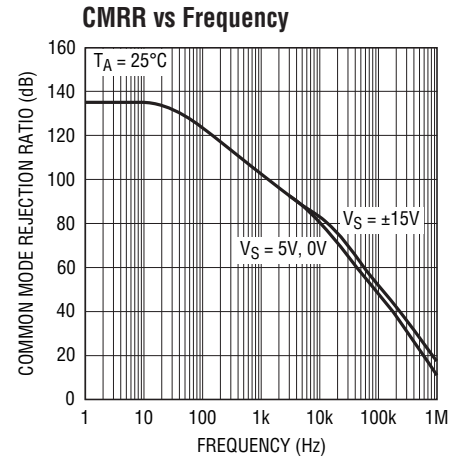

6011 G21

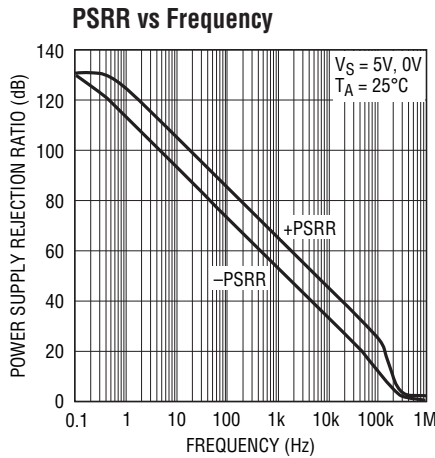

6011 G22

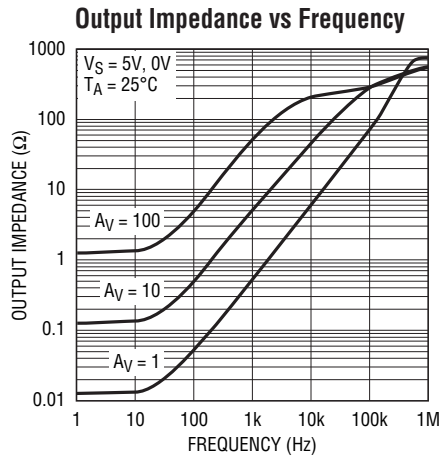

6011 G23

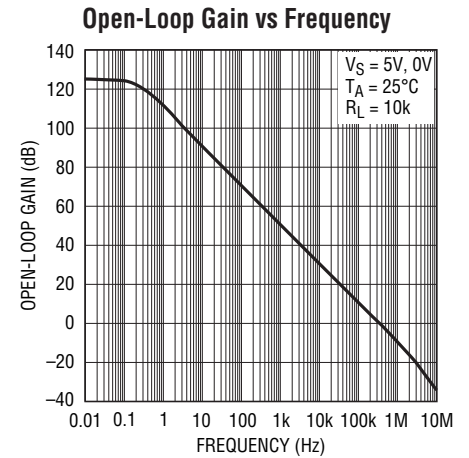

6011 G24

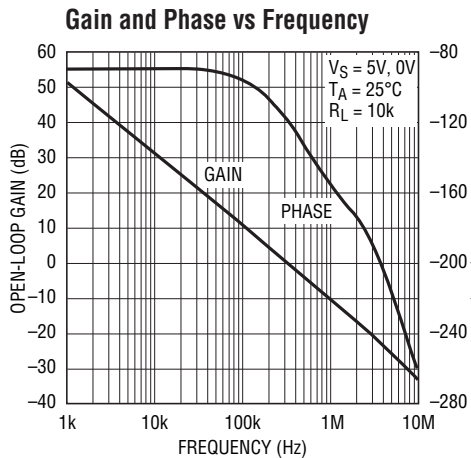

6011 G25

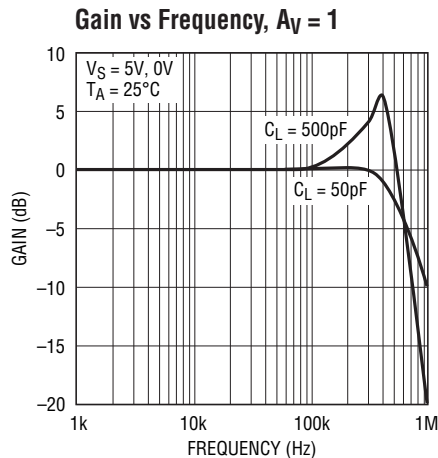

6011 G26

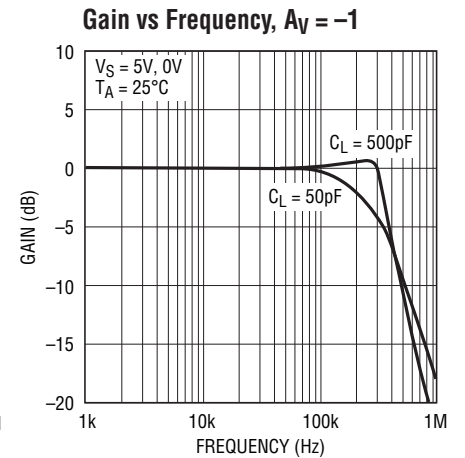

6011 G27

TYPICAL PERFORMANCE CHARACTERISTICS

Small-Signal Transient Response

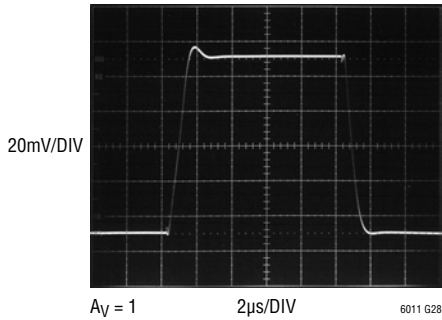

Large-Signal Transient Response

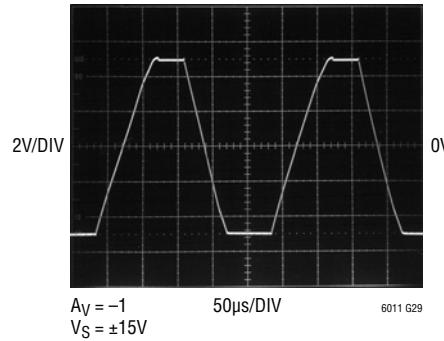

Rail-to-Rail Output Swing

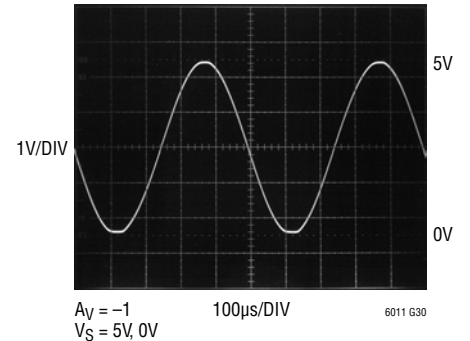

APPLICATIONS INFORMATION

Preserving Input Precision

Preserving the input accuracy of the LT6011/LT6012 requires that the applications circuit and PC board layout do not introduce errors comparable to or greater than the 25 μ V typical offset of the amplifiers. Temperature differentials across the input connections can generate thermocouple voltages of 10's of microvolts so the connections to the input leads should be short, close together and away from heat dissipating components. Air currents across the board can also generate temperature differentials.

The extremely low input bias currents (20pA typical) allow high accuracy to be maintained with high impedance sources and feedback resistors. The LT6011/LT6012 low input bias currents are obtained by a cancellation circuit on-chip. This causes the resulting I_{B^+} and I_{B^-} to be uncorrelated, as implied by the I_{OS} specification being comparable to I_B . Do not try to balance the input resistances in each input lead; instead keep the resistance at either input as low as possible for maximum accuracy.

Leakage currents on the PC board can be higher than the input bias current. For example, 10G Ω of leakage between a 15V supply lead and an input lead will generate 1.5nA! Surround the input leads with a guard ring driven to the same potential as the input common mode to avoid excessive leakage in high impedance applications.

Input Protection

The LT6011/LT6012 feature on-chip back-to-back diodes between the input devices, along with 500 Ω resistors in series with either input. This internal protection limits the input current to approximately 10mA (the maximum allowed) for a 10V differential input voltage. Use additional external series resistors to limit the input current to 10mA in applications where differential inputs of more than 10V are expected. For example, a 1k resistor in series with each input provides protection against 30V differential voltage.

Input Common Mode Range

The LT6011/LT6012 output is able to swing close to each power supply rail (rail-to-rail out), but the input stage is limited to operating between $V^- + 1V$ and $V^+ - 1.2V$. Exceeding this common mode range will cause the gain to drop to zero, however, no phase reversal will occur.

Total Input Noise

The LT6011/LT6012 amplifier contributes negligible noise to the system when driven by sensors (sources) with impedance between 20k Ω and 1M Ω . Throughout this range, total input noise is dominated by the 4kTR_S noise of the source. If the source impedance is less than 20k Ω , the input voltage noise of the amplifier starts to contribute

APPLICATIONS INFORMATION

with a minimum noise of $14\text{nV}/\sqrt{\text{Hz}}$ for very low source impedance. If the source impedance is more than $1\text{M}\Omega$, the input current noise of the amplifier, multiplied by this high impedance, starts to contribute and eventually dominate. Total input noise spectral density can be calculated as:

$$V_{n(\text{TOTAL})} = \sqrt{e_n^2 + 4kTR_S + (i_n R_S)^2}$$

where $e_n = 14\text{nV}/\sqrt{\text{Hz}}$, $i_n = 0.1\text{pA}/\sqrt{\text{Hz}}$ and R_S is the total impedance at the input, including the source impedance.

Capacitive Loads

The LT6011/LT6012 can drive capacitive loads up to 500pF in unity gain. The capacitive load driving capability increases as the amplifier is used in higher gain configurations.

A small series resistance between the output and the load further increases the amount of capacitance that the amplifier can drive.

Rail-to-Rail Operation

The LT6011/LT6012 outputs can swing to within millivolts of either supply rail, but the inputs can not. However, for most op amp configurations, the inputs need to swing less than the outputs. Figure 1 shows the basic op amp configurations, lists what happens to the op amp inputs and specifies whether or not the op amp must have rail-to-rail inputs. Select a rail-to-rail input op amp only when really necessary, because the input precision specifications are usually inferior.

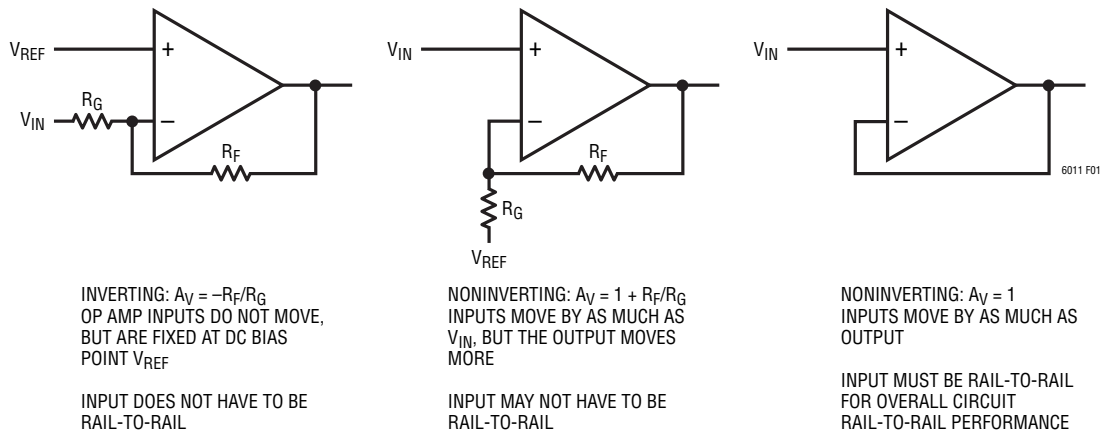
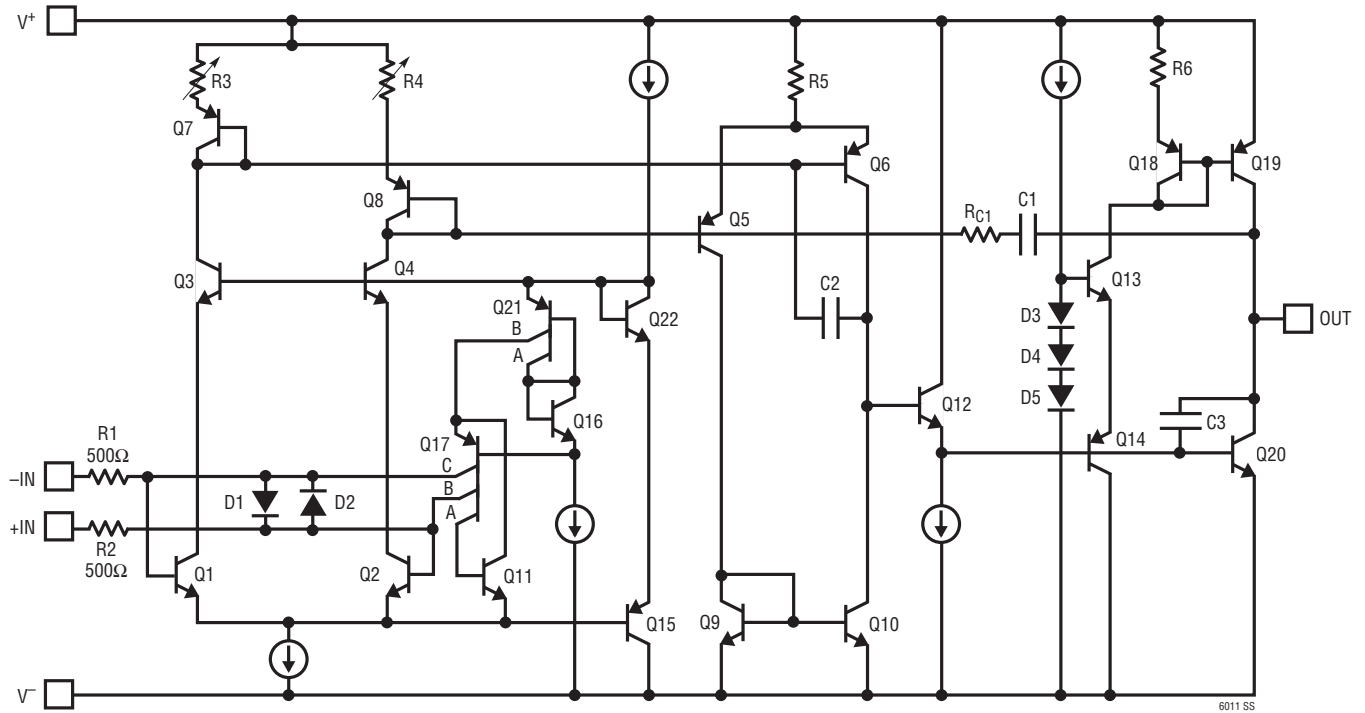

Figure 1. Some Op Amp Configurations Do Not Require Rail-to-Rail Inputs to Achieve Rail-to-Rail Outputs

SIMPLIFIED SCHEMATIC (One Amplifier)



PACKAGE DESCRIPTION

Please refer to <http://www.linear.com/designtools/packaging/> for the most recent package drawings.

DD Package
8-Lead Plastic DFN (3mm × 3mm)
 (Reference LTC DWG # 05-08-1698 Rev C)

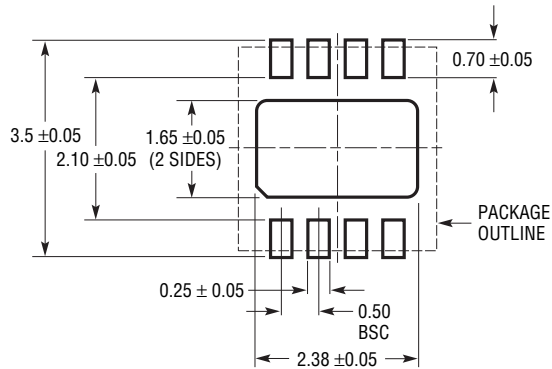

RECOMMENDED SOLDER PAD PITCH AND DIMENSIONS
 APPLY SOLDER MASK TO AREAS THAT ARE NOT SOLDERED

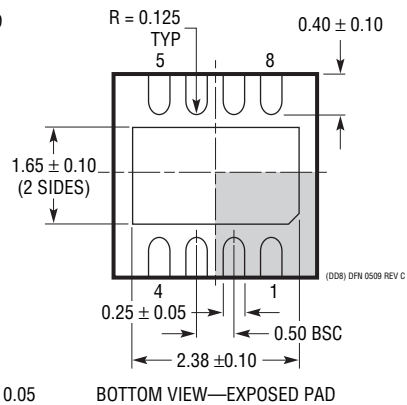
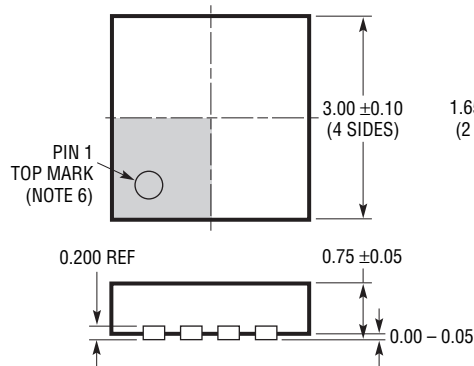

NOTE:

1. DRAWING TO BE MADE A JEDEC PACKAGE OUTLINE M0-229 VARIATION OF (WEED-1)
2. DRAWING NOT TO SCALE
3. ALL DIMENSIONS ARE IN MILLIMETERS
4. DIMENSIONS OF EXPOSED PAD ON BOTTOM OF PACKAGE DO NOT INCLUDE MOLD FLASH. MOLD FLASH, IF PRESENT, SHALL NOT EXCEED 0.15mm ON ANY SIDE
5. EXPOSED PAD SHALL BE SOLDER PLATED
6. SHADED AREA IS ONLY A REFERENCE FOR PIN 1 LOCATION ON TOP AND BOTTOM OF PACKAGE

PACKAGE DESCRIPTION

Please refer to <http://www.linear.com/designtools/packaging/> for the most recent package drawings.

S8 Package 8-Lead Plastic Small Outline (Narrow .150 Inch) (Reference LTC DWG # 05-08-1610)

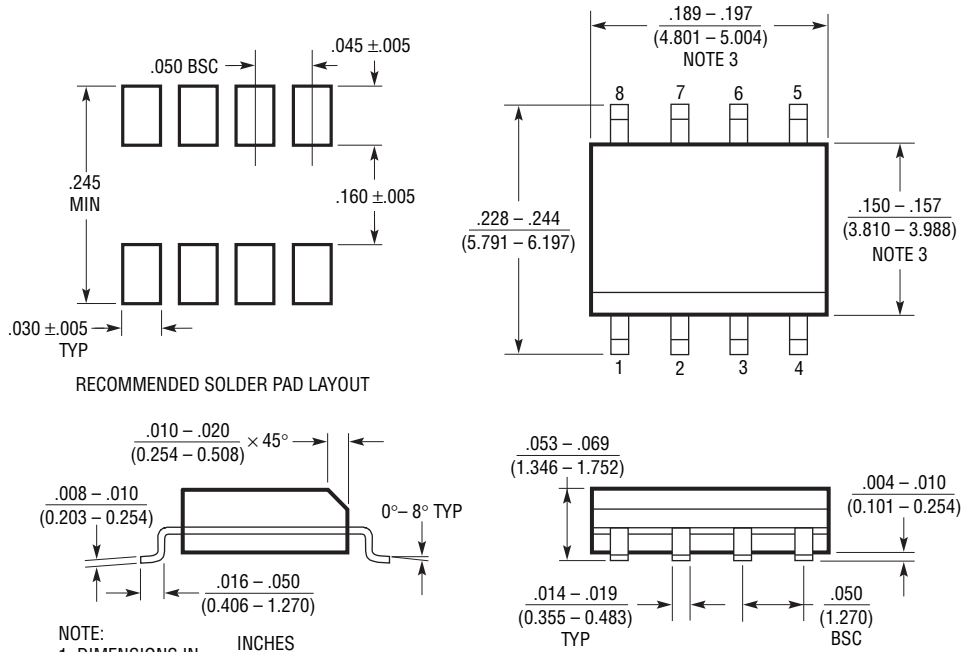

- NOTE:
1. DIMENSIONS IN $\frac{\text{INCHES}}{\text{MILLIMETERS}}$
 2. DRAWING NOT TO SCALE
 3. THESE DIMENSIONS DO NOT INCLUDE MOLD FLASH OR PROTRUSIONS.
MOLD FLASH OR PROTRUSIONS SHALL NOT EXCEED $.006"$ (0.15mm)

S08 0303

PACKAGE DESCRIPTION

Please refer to <http://www.linear.com/designtools/packaging/> for the most recent package drawings.

MS8 Package 8-Lead Plastic MSOP

(Reference LTC DWG # 05-08-1660 Rev F)

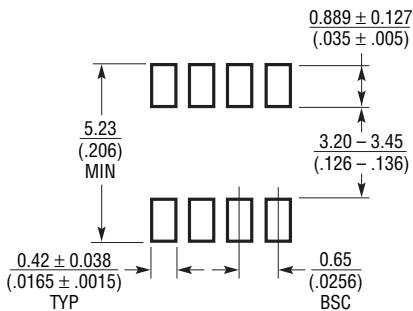

RECOMMENDED SOLDER PAD LAYOUT

NOTE:

1. DIMENSIONS IN MILLIMETER/(INCH)
2. DRAWING NOT TO SCALE
3. DIMENSION DOES NOT INCLUDE MOLD FLASH, PROTRUSIONS OR GATE BURRS.
MOLD FLASH, PROTRUSIONS OR GATE BURRS SHALL NOT EXCEED 0.152mm (.006") PER SIDE
4. DIMENSION DOES NOT INCLUDE INTERLEAD FLASH OR PROTRUSIONS.
INTERLEAD FLASH OR PROTRUSIONS SHALL NOT EXCEED 0.152mm (.006") PER SIDE
5. LEAD COPLANARITY (BOTTOM OF LEADS AFTER FORMING) SHALL BE 0.102mm (.004") MAX

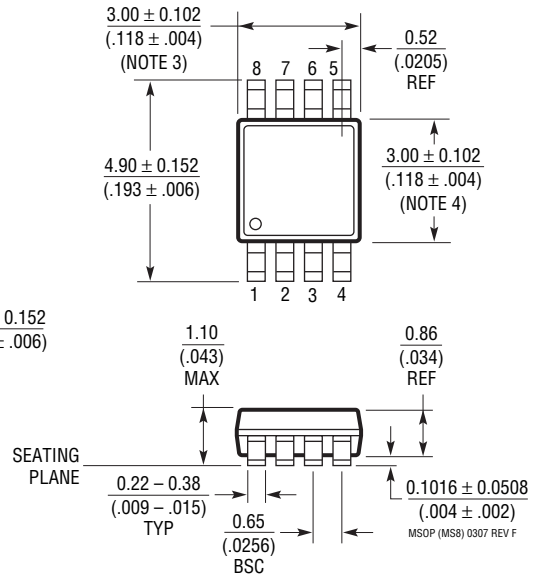
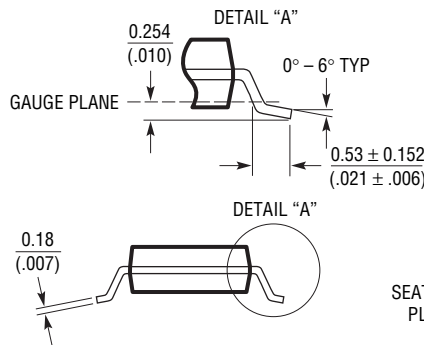

PACKAGE DESCRIPTION

Please refer to <http://www.linear.com/designtools/packaging/> for the most recent package drawings.

S14 Package 14-Lead Plastic Small Outline (Narrow .150 Inch) (Reference LTC DWG # 05-08-1610)

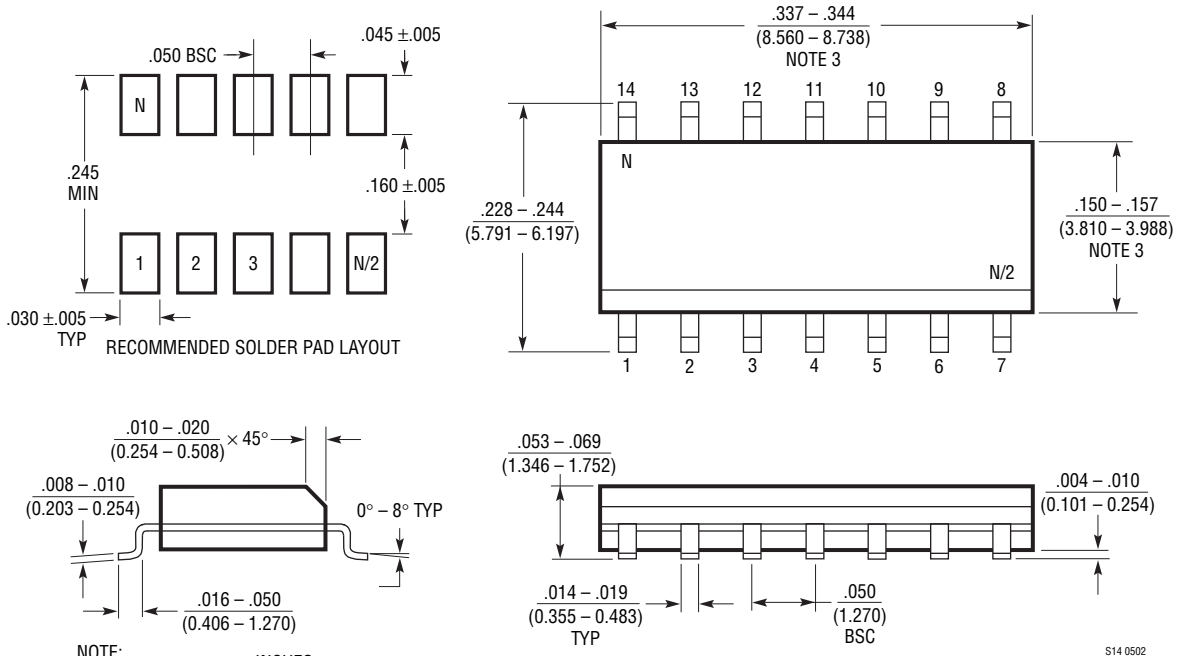

- NOTE:
1. DIMENSIONS IN $\frac{\text{INCHES}}{\text{MILLIMETERS}}$
 2. DRAWING NOT TO SCALE
 3. THESE DIMENSIONS DO NOT INCLUDE MOLD FLASH OR PROTRUSIONS. MOLD FLASH OR PROTRUSIONS SHALL NOT EXCEED $.006''$ (0.15mm)

S14 0502

PACKAGE DESCRIPTION

Please refer to <http://www.linear.com/designtools/packaging/> for the most recent package drawings.

GN Package 16-Lead Plastic SSOP (Narrow .150 Inch) (Reference LTC DWG # 05-08-1641)

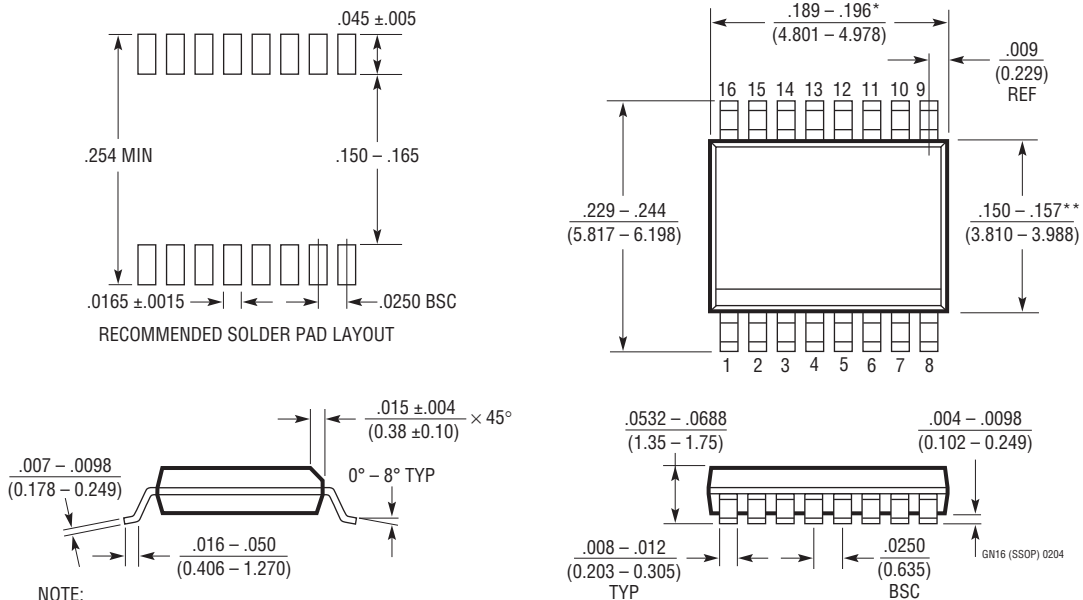

NOTE:

1. CONTROLLING DIMENSION: INCHES

2. DIMENSIONS ARE IN $\frac{\text{INCHES}}{\text{MILLIMETERS}}$

3. DRAWING NOT TO SCALE

*DIMENSION DOES NOT INCLUDE MOLD FLASH. MOLD FLASH SHALL NOT EXCEED 0.006" (0.152mm) PER SIDE

**DIMENSION DOES NOT INCLUDE INTERLEAD FLASH. INTERLEAD FLASH SHALL NOT EXCEED 0.010" (0.254mm) PER SIDE

REVISION HISTORY (Revision history begins at Rev C)

REV	DATE	DESCRIPTION	PAGE NUMBER
C	01/12	Removed specific package information from the Absolute Maximum Ratings section. Added a new Typical Application drawing.	2 20