

## FEATURES

- **Input Common Mode Range:  $V^-$  to  $V^- + 76V$**
- **Rail-to-Rail Input and Output**
- **Low Power: 315 $\mu$ A/Amplifier**
- **Operating Temperature Range:  $-55^\circ\text{C}$  to  $150^\circ\text{C}$**
- **$V_{OS}$ :  $\pm 50\mu\text{V}$  (Maximum)**
- **CMRR, PSRR: 126dB**
- Reverse Battery Protection to 50V
- Gain Bandwidth Product: 3.2MHz
- Specified on 5V and  $\pm 15V$  Supplies
- High Voltage Gain: 1000V/mV
- No Phase Reversal
- No Supply Sequencing Problems
- Single 5-Lead SOT-23 (ThinSOT™) Package
- Dual 8-Lead MSOP
- Quad 22-Lead DFN (6mm  $\times$  3mm)

## APPLICATIONS

- High Side or Low Side Current Sensing
- Battery/Power Supply Monitoring
- 4mA to 20mA Transmitters
- High Voltage Data Acquisition
- Battery/Portable Instrumentation

## DESCRIPTION

The **LT<sup>®</sup>6015/LT6016/LT6017** are single/dual/quad rail-to-rail input operational amplifiers with input offset voltage trimmed to less than 50 $\mu\text{V}$ . These amplifiers operate on single and split supplies with a total voltage of 3V to 50V and draw only 315 $\mu\text{A}$  per amplifier. They are reverse battery protected, drawing very little current for reverse supplies up to 50V.

The Over-The-Top<sup>®</sup> input stage of the LT6015/LT6016/LT6017 is designed to provide added protection in tough environments. The input common mode range extends from  $V^-$  to  $V^+$  and beyond: these amplifiers operate with inputs up to 76V above  $V^-$  independent of  $V^+$ . Internal resistors protect the inputs against transient faults up to 25V below the negative supply. The LT6015/LT6016/LT6017 can drive loads up to 25mA and are unity-gain stable with capacitive loads as large as 200pF. Optional external compensation can be added to extend the capacitive drive capability beyond 200pF.

The LT6015 is offered in a 5-lead SOT package. The LT6016 dual op amp is available in an 8-lead MSOP package. The LT6017 is offered in a 22-pin leadless DFN package.

LT, LT, LTC, LTM, Linear Technology, Over-The-Top and the Linear logo are registered trademarks and ThinSOT is a trademark of Linear Technology Corporation. All other trademarks are the property of their respective owners.

## TYPICAL APPLICATION

**Precision High Voltage High Side Load Current Monitor**

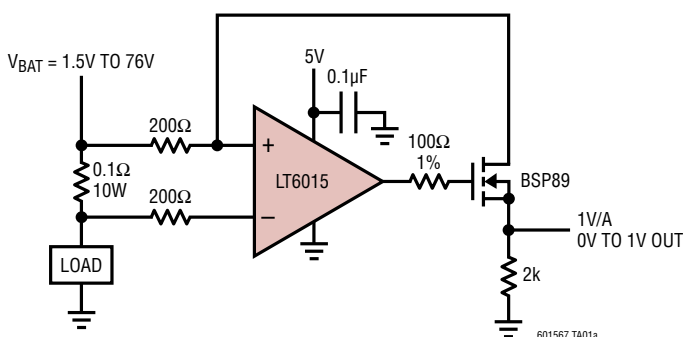

**Output Error vs Load Current**

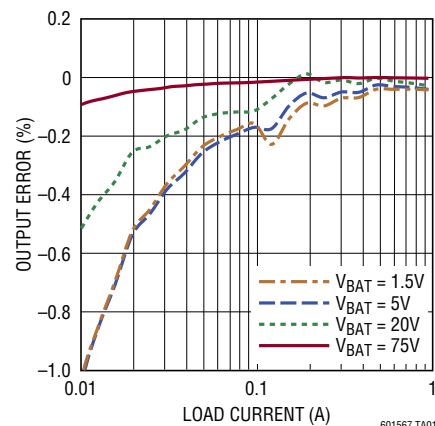

# LT6015/LT6016/LT6017

## ABSOLUTE MAXIMUM RATINGS (Note 1)

Supply Voltage ( $V^+$ to $V^-$ ).....	60V, -50V	Temperature Range (Notes 4, 5)	
Input Differential Voltage .....	$\pm 80V$	LT6015I/LT6016I/LT6017I.....	-40°C to 85°C
Input Voltage (Note 2).....	80V, -25V	LT6015H/LT6016H/LT6017H.....	-40°C to 125°C
Input Current (Note 2).....	$\pm 10mA$	LT6015MP/LT6016MP/LT6017MP	
Output Short-Circuit Duration		( $T_{JUNCTION}$ ) .....	-55°C to 150°C
(Note 3).....	Continuous	Storage Temperature Range .....	-65°C to 150°C
		Maximum Junction Temperature .....	150°C
		Lead Temperature (Soldering, 10sec).....	300°C

## PIN CONFIGURATION

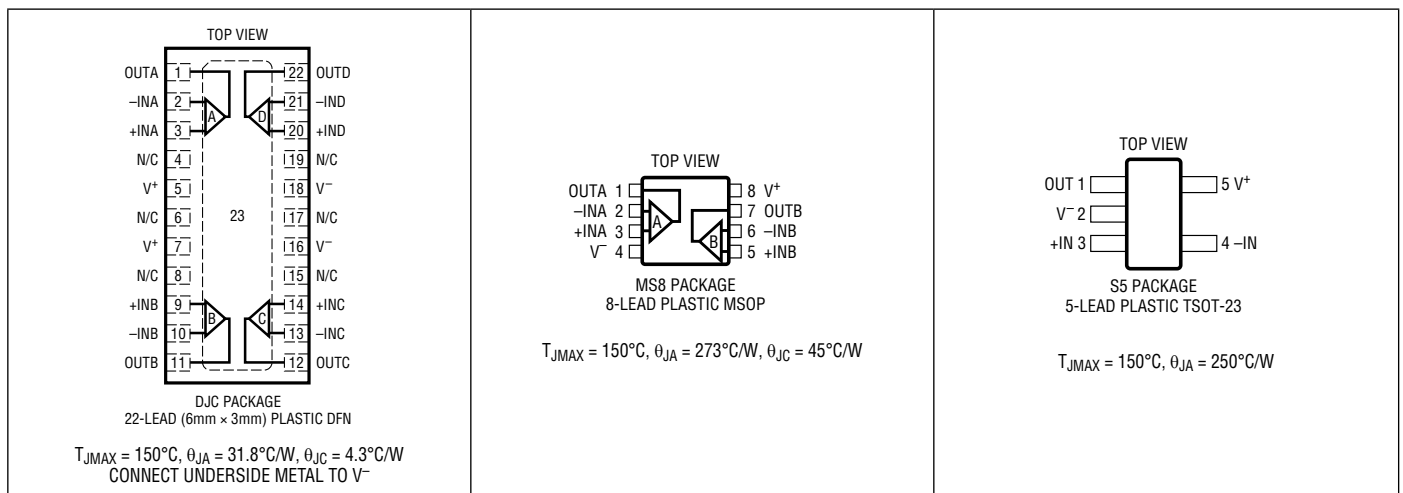

## ORDER INFORMATION

### Lead Free Finish

TAPE AND REEL (MINI)	TAPE AND REEL	PART MARKING*	PACKAGE DESCRIPTION	TEMPERATURE RANGE
LT6015IS5#TRMPBF	LT6015IS5#TRPBF	LTGJD	5-Lead Plastic TSOT-23	-40°C to 85°C
LT6015HS5#TRMPBF	LT6015HS5#TRPBF	LTGJD	5-Lead Plastic TSOT-23	-40°C to 125°C
LT6015MPS5#TRMPBF	LT6015MPS5#TRPBF	LTGJD	5-Lead Plastic TSOT-23	-55°C to 150°C

TRM = 500 pieces. Consult LTC Marketing for information on lead based finish parts.

LEAD FREE FINISH	TAPE AND REEL	PART MARKING*	PACKAGE DESCRIPTION	TEMPERATURE RANGE
LT6016IMS8#PBF	LT6016IMS8#TRPBF	LTGFK	8-Lead Plastic MSOP	-40°C to 85°C
LT6016HMS8#PBF	LT6016HMS8#TRPBF	LTGFK	8-Lead Plastic MSOP	-40°C to 125°C
LT6016MPMS8#PBF	LT6016MPMS8#TRPBF	LTGFK	8-Lead Plastic MSOP	-55°C to 150°C
LT6017IDJC#PBF	LT6017IDJC#TRPBF	6017	22-Lead Plastic DFN	-40°C to 85°C
LT6017HDJC#PBF	LT6017HDJC#TRPBF	6017	22-Lead Plastic DFN	-40°C to 125°C
LT6017MPDJC#PBF	LT6017MPDJC#TRPBF	6017	22-Lead Plastic DFN	-55°C to 150°C

Consult LTC Marketing for parts specified with wider operating temperature ranges. \*The temperature grade is identified by a label on the shipping container.

For more information on lead free part marking, go to: <http://www.linear.com/leadfree/>

For more information on tape and reel specifications, go to: <http://www.linear.com/tapeandreel/>

601567ff

**ELECTRICAL CHARACTERISTICS** The ● denotes the specifications which apply over the specified temperature range,  $-40^{\circ}\text{C} < T_A < 85^{\circ}\text{C}$  for I-grade parts,  $-40^{\circ}\text{C} < T_A < 125^{\circ}\text{C}$  for H-grade parts, otherwise specifications are at  $T_A = 25^{\circ}\text{C}$ ,  $V_S = 5\text{V}$ ,  $V_{CM} = V_{OUT} = \text{mid-supply}$ .

SYMBOL	PARAMETER	CONDITIONS	I-, H-GRADE			UNITS
			MIN	TYP	MAX	
$V_{OS}$	Input Offset Voltage	$0 < V_{CM} < V^+ - 1.75\text{V}$ MS8 Package	-50	±25	50	μV
		$0 < V_{CM} < V^+ - 1.75\text{V}$ SOT-23, DJC22 Packages	-80	±45	80	μV
		$V_{CM} = 5\text{V}$	-125	±50	125	μV
		$V_{CM} = 76\text{V}$	-135	±50	135	μV
		$0 < V_{CM} < V^+ - 1.75\text{V}$ $V_{CM} = 5\text{V to } V_{CM} = 76\text{V}$	● -250	● ±45	● 250	μV
			● -350	● ±50	● 350	μV
$\frac{\Delta V_{OS}}{\Delta \text{TEMP}}$	Input Offset Voltage Drift			0.75		μV/°C
$\frac{\Delta V_{OS}}{\Delta \text{TIME}}$	Long Term Voltage Offset Stability			0.75		μV/Mo
$I_B$	Input Bias Current	$0.25\text{V} < V_{CM} < V^+ - 1.75\text{V}$ $V_{CM} = 0\text{V}$	-5	±2	5	nA
		$V_{CM} = 5\text{V to } 76\text{V}$	-60	-16.5	0	nA
		$0.25\text{V} < V_{CM} < V^+ - 1.75\text{V}$ $V_{CM} = 0\text{V}$	11	14	17.5	μA
		$V_{CM} = 5\text{V to } 76\text{V}$	● -15	● ±2	● 15	nA
		$V_S = 0\text{V}, V_{CM} = 0\text{V to } 76\text{V}$	● -150	● -16.5	● 0	nA
			● 7	● 14	● 23	μA
			● 0.001	● 1	μA	
$I_{OS}$	Input Offset Current	$0.25\text{V} < V_{CM} < V^+ - 1.75\text{V}$ $V_{CM} = 0\text{V}$	-5	±2	5	nA
		$V_{CM} = 5\text{V to } 76\text{V}$ (Note 6)	-5	±2	5	nA
		$0.25\text{V} < V_{CM} < V^+ - 1.75\text{V}$ $V_{CM} = 0\text{V}$	● -500	● ±50	● 500	nA
		$V_{CM} = 5\text{V to } 76\text{V}$ (Note 6)	● -15	● ±2	● 15	nA
			● -500	● ±50	● 500	nA
$V_{CMR}$	Common Mode Input Range		● 0		76	V
$C_{IN}$	Differential Input Capacitance			5		pF
$R_{IN}$	Differential Input Resistance	$0 < V_{CM} < V^+ - 1.75\text{V}$ $V_{CM} > V^+$		1		MΩ
				3.7		kΩ
$R_{INCM}$	Common Mode Input Resistance	$0 < V_{CM} < V^+ - 1.75\text{V}$ $V_{CM} > V^+$		>1		GΩ
				>100		MΩ
$e_n$	Input Referred Noise Voltage Density	$f = 1\text{kHz}$ $V_{CM} < V^+ - 1.75\text{V}$ $V_{CM} > V^+$		18		nV/√Hz
	Input Referred Noise Voltage	$f = 0.1\text{Hz to } 10\text{Hz}$ $V_{CM} < V^+ - 1.75\text{V}$		25		nV/√Hz
				0.5		μV <sub>P-P</sub>
$i_n$	Input Referred Noise Current Density	$f = 1\text{kHz}$ $V_{CM} < V^+ - 1.75\text{V}$ $V_{CM} > V^+$		0.1		pA/√Hz
				11.5		pA/√Hz
$A_{VOL}$	Open Loop Gain	$R_L = 10\text{k}\Omega$ $\Delta V_{OUT} = 3\text{V}$	● 300	3000		V/mV
$PSRR$	Supply Rejection Ratio	$V_S = \pm 1.65\text{V to } \pm 15\text{V}$ $V_{CM} = V_{OUT} = \text{Mid-Supply}$	● 110	126		dB
$CMRR$	Input Common Mode Rejection Ratio	$V_{CM} = 0\text{V to } 3.25\text{V}$	● 100	126		dB
		$V_{CM} = 5\text{V to } 76\text{V}$	● 126	140		dB
$V_{OL}$	Output Voltage Swing Low	$V_S = 5\text{V}$ , No Load	●	3	55	mV
		$V_S = 5\text{V}$ , $I_{SINK} = 5\text{mA}$	●	280	500	mV
$V_{OH}$	Output Voltage Swing High	$V_S = 5\text{V}$ , No Load	●	450	700	mV
		$V_S = 5\text{V}$ , $I_{SOURCE} = 5\text{mA}$	●	1000	1250	mV
$I_{SC}$	Short-Circuit Current	$V_S = 5\text{V}$ , $50\Omega$ to $V^+$	● 10	25		mA
		$V_S = 5\text{V}$ , $50\Omega$ to $V^-$	● 10	25		mA

# LT6015/LT6016/LT6017

**ELECTRICAL CHARACTERISTICS** The ● denotes the specifications which apply over the specified temperature range,  $-40^{\circ}\text{C} < T_A < 85^{\circ}\text{C}$  for I-grade parts,  $-40^{\circ}\text{C} < T_A < 125^{\circ}\text{C}$  for H-grade parts, otherwise specifications are at  $T_A = 25^{\circ}\text{C}$ ,  $V_S = 5\text{V}$ ,  $V_{CM} = V_{OUT} = \text{mid-supply}$ .

SYMBOL	PARAMETER	CONDITIONS	I-, H-GRADE			UNITS
			MIN	TYP	MAX	
GBW	Gain Bandwidth Product	$f_{TEST} = 100\text{kHz}$	●	2.85	3.2	MHz
				2.5	3.2	MHz
SR	Slew Rate	$\Delta V_{OUT} = 3\text{V}$	●	0.55	0.75	V/ $\mu\text{s}$
				0.45	0.75	V/ $\mu\text{s}$
$t_S$	Settling Time Due to Input Step $\Delta V_{OUT} = \pm 2\text{V}$	0.1% Settling		3.5	$\mu\text{s}$	
$V_S$	Supply Voltage		●	3	50	V
	Reverse Supply (Note 7)	$I_S < -25\mu\text{A}/\text{Amplifier}$	●	3.3	50	V
					-65	-50
$I_S$	Supply Current Per Amplifier	SOT-23 Package MS8, DJC22 Packages	●		315	$\mu\text{A}$
					315	$\mu\text{A}$
					315	$\mu\text{A}$
$R_O$	Output Impedance	$\Delta I_O = \pm 5\text{mA}$		0.15	$\Omega$	

The ● denotes the specifications which apply over the specified temperature range,  $-40^{\circ}\text{C} < T_A < 85^{\circ}\text{C}$  for I-grade parts,  $-40^{\circ}\text{C} < T_A < 125^{\circ}\text{C}$  for H-grade parts, otherwise specifications are at  $T_A = 25^{\circ}\text{C}$ ,  $V_S = \pm 15\text{V}$ ,  $V_{CM} = V_{OUT} = \text{mid-supply}$ .

SYMBOL	PARAMETER	CONDITIONS	I-, H-GRADE			UNITS	
			MIN	TYP	MAX		
$V_{OSI}$	Input Offset Voltage	$V_S = \pm 25\text{V}$ $V_S = \pm 25\text{V}$	●	-80	$\pm 55$	80	$\mu\text{V}$
				-250	$\pm 55$	250	$\mu\text{V}$
				-110	$\pm 75$	110	$\mu\text{V}$
				-250	$\pm 75$	250	$\mu\text{V}$
$\frac{\Delta V_{OSI}}{\Delta \text{TEMP}}$	Input Offset Voltage Drift			0.75	$\mu\text{V}/^{\circ}\text{C}$		
$I_B$	Input Bias Current		●	-5	$\pm 2$	5	nA
				-15	$\pm 2$	15	nA
$I_{OS}$	Input Offset Current		●	-5	$\pm 2$	5	nA
				-15	$\pm 2$	15	nA
$V_{CMR}$	Common Mode Input Range		●	-15	61	V	
$C_{IN}$	Differential Input Capacitance			5		pF	
$R_{IN}$	Differential Input Resistance	$0 < V_{CM} < V^+ - 1.75\text{V}$ $V_{CM} > V^+$			1	M $\Omega$	
					3.7	k $\Omega$	
$R_{INCM}$	Common Mode Input Resistance	$0 < V_{CM} < V^+ - 1.75\text{V}$ $V_{CM} > V^+$			>1	G $\Omega$	
					>100	M $\Omega$	
$e_n$	Input Referred Noise Voltage Density	$f = 1\text{kHz}$ $V_{CM} < V^+ - 1.75\text{V}$ $V_{CM} > V^+$			18	$\text{nV}/\sqrt{\text{Hz}}$	
	Input Referred Noise Voltage	$f = 0.1\text{Hz to } 10\text{Hz}$ $V_{CM} < V^+ - 1.25\text{V}$			25	$\text{nV}/\sqrt{\text{Hz}}$	
$i_n$	Input Referred Noise Current Density	$f = 1\text{kHz}$ $V_{CM} < V^+ - 1.75\text{V}$ $V_{CM} > V^+$			0.1	$\text{pA}/\sqrt{\text{Hz}}$	
					11.5	$\text{pA}/\sqrt{\text{Hz}}$	
$A_{VOL}$	Open Loop Gain	$R_L = 10\text{k}\Omega$ $\Delta V_{OUT} = 27\text{V}$	●	200	1000	V/mV	
$\text{PSRR}$	Supply Rejection Ratio	$V_S = \pm 2.5\text{V to } \pm 25\text{V}$ $V_{CM} = V_{OUT} = 0\text{V}$	●	114	126	dB	
$\text{CMRR}$	Input Common Mode Rejection Ratio	$V_{CM} = -15\text{V to } 13.25\text{V}$	●	110	126	dB	
$V_{OL}$	Output Voltage Swing Low	$V_S = \pm 15\text{V}$ , No Load $V_S = \pm 15\text{V}$ , $I_{SINK} = 5\text{mA}$	●		3	55	mV
			●		280	500	mV
$V_{OH}$	Output Voltage Swing High	$V_S = \pm 15\text{V}$ , No Load $V_S = \pm 15\text{V}$ , $I_{SOURCE} = 5\text{mA}$	●		450	700	mV
			●		1000	1250	mV

601567ff

**ELECTRICAL CHARACTERISTICS** The ● denotes the specifications which apply over the specified temperature range,  $-40^{\circ}\text{C} < T_A < 85^{\circ}\text{C}$  for I-grade parts,  $-40^{\circ}\text{C} < T_A < 125^{\circ}\text{C}$  for H-grade parts, otherwise specifications are at  $T_A = 25^{\circ}\text{C}$ ,  $V_S = \pm 15\text{V}$ ,  $V_{CM} = V_{OUT} = \text{mid-supply}$ .

SYMBOL	PARAMETER	CONDITIONS	I-, H-GRADE			UNITS
			MIN	TYP	MAX	
I <sub>SC</sub>	Short-Circuit Current	V <sub>S</sub> = ±15V, 50Ω to GND V <sub>S</sub> = ±15V, 50Ω to GND	●	10	30	mA
			●	10	32	
GBW	Gain Bandwidth Product	f <sub>TEST</sub> = 100kHz	●	2.9	3.3	MHz
				2.55	3.3	
SR	Slew Rate	ΔV <sub>OUT</sub> = 3V	●	0.6	0.8	V/μs
				0.5	0.8	
t <sub>S</sub>	Settling Time Due to Input Step	0.1% Settling ΔV <sub>OUT</sub> = ±2V		3.5	μs	
V <sub>S</sub>	Supply Voltage		●	3	50	V
	Reverse Supply	I <sub>S</sub> = -25μA/Amplifier	●	3.3	50	V
I <sub>S</sub>	Supply Current Per Amplifier	SOT-23 Package MS8, DJC22 Packages  V <sub>S</sub> = ±25V, SOT-23 Package V <sub>S</sub> = ±25V, MS8, DJC22 Package V <sub>S</sub> = ±25V	●		-65	μA
			●		-30	
			●			
			●			
			●			
R <sub>O</sub>	Output Impedance	ΔI <sub>O</sub> = ±5mA		0.15	Ω	

The ● denotes the specifications which apply over the specified temperature range,  $-55^{\circ}\text{C} < T_{JUNCTION} < 150^{\circ}\text{C}$  for MP-grade parts, otherwise specifications are at  $T_A = 25^{\circ}\text{C}$ ,  $V_S = 5\text{V}$ ,  $V_{CM} = V_{OUT} = \text{mid-supply}$ .

SYMBOL	PARAMETER	CONDITIONS	MP-GRADE			UNITS	
			MIN	TYP	MAX		
V <sub>OS</sub>	Input Offset Voltage	0 < V <sub>CM</sub> < V <sup>+</sup> - 1.75V MS8 Package 0 < V <sub>CM</sub> < V <sup>+</sup> - 1.75V DJC22 Package V <sub>CM</sub> = 5V V <sub>CM</sub> = 76V 0 < V <sub>CM</sub> < V <sup>+</sup> - 1.75V V <sub>CM</sub> = 5V to V <sub>CM</sub> = 76V		-50	±25	50	μV
							μV
			●	-80	±45	80	μV
			●	-125	±50	125	μV
			●	-135	±50	135	μV
ΔV <sub>OS</sub> ΔTEMP	Input Offset Voltage Drift		●	-500	±45	500	μV
			●	-600	±50	600	μV
				0.75		μV/°C	
ΔV <sub>OS</sub> ΔTIME	Long Term Voltage Offset Stability			0.75		μV/Mo	
I <sub>B</sub>	Input Bias Current	0.25V < V <sub>CM</sub> < V <sup>+</sup> - 1.75V V <sub>CM</sub> = 0V V <sub>CM</sub> = 5V to 76V 0.25V < V <sub>CM</sub> < V <sup>+</sup> - 1.75V V <sub>CM</sub> = 0V V <sub>CM</sub> = 5V to 76V V <sub>S</sub> = 0V, V <sub>CM</sub> = 0V to 76V	●	-5	±2	5	nA
			●	-60	-16.5	0	nA
			●	11	14	17.5	μA
			●	-100	±2	100	nA
			●	-500	-16.5	0	nA
I <sub>OS</sub>	Input Offset Current	0.25V < V <sub>CM</sub> < V <sup>+</sup> - 1.75V V <sub>CM</sub> = 0V V <sub>CM</sub> = 5V to 76V (Note 6) 0.25V < V <sub>CM</sub> < V <sup>+</sup> - 1.75V V <sub>CM</sub> = 0V V <sub>CM</sub> = 5V to 76V (Note 6)	●	6.5	14	24	μA
			●		0.001	4	μA
			●	-5	±2	5	nA
			●	-5	±2	5	nA
			●	-500	±50	500	nA
V <sub>CMR</sub>	Common Mode Input Range		●	-50	±2	50	nA
			●	-200	±2	200	nA
			●	-500	±150	500	nA
			●	0		76	V
			●				
C <sub>IN</sub>	Differential Input Capacitance			5		pF	
R <sub>IN</sub>	Differential Input Resistance	0 < V <sub>CM</sub> < V <sup>+</sup> - 1.75V V <sub>CM</sub> > V <sup>+</sup>		1		MΩ	
				3.7		kΩ	
R <sub>INCM</sub>	Common Mode Input Resistance	0 < V <sub>CM</sub> < V <sup>+</sup> - 1.75V V <sub>CM</sub> > V <sup>+</sup>		>1		GΩ	
				>100		MΩ	

601567ff

# LT6015/LT6016/LT6017

**ELECTRICAL CHARACTERISTICS** The ● denotes the specifications which apply over the specified temperature range,  $-55^{\circ}\text{C} < T_{\text{JUNCTION}} < 150^{\circ}\text{C}$  for MP-grade parts, otherwise specifications are at  $T_A = 25^{\circ}\text{C}$ ,  $V_S = 5\text{V}$ ,  $V_{\text{CM}} = V_{\text{OUT}} = \text{mid-supply}$ .

SYMBOL	PARAMETER	CONDITIONS	MP-GRADE			UNITS	
			MIN	TYP	MAX		
$e_n$	Input Referred Noise Voltage Density	$f = 1\text{kHz}$ $V_{\text{CM}} < V^+ - 1.75\text{V}$ $V_{\text{CM}} > V^+$		18 25		$\text{nV}/\sqrt{\text{Hz}}$ $\text{nV}/\sqrt{\text{Hz}}$	
	Input Referred Noise Voltage	$f = 0.1\text{Hz to } 10\text{Hz}$ $V_{\text{CM}} < V^+ - 1.75\text{V}$		0.5		$\mu\text{V}_{\text{P-P}}$	
$i_n$	Input Referred Noise Current Density	$f = 1\text{kHz}$ $V_{\text{CM}} < V^+ - 1.75\text{V}$ $V_{\text{CM}} > V^+$		0.1 11.5		$\text{pA}/\sqrt{\text{Hz}}$ $\text{pA}/\sqrt{\text{Hz}}$	
$A_{\text{VOL}}$	Open Loop Gain	$R_L = 10\text{k}\Omega$ $\Delta V_{\text{OUT}} = 3\text{V}$	●	200	3000	$\text{V/mV}$	
PSRR	Supply Rejection Ratio	$V_S = \pm 1.65\text{V to } \pm 15\text{V}$ $V_{\text{CM}} = V_{\text{OUT}} = \text{Mid-Supply}$	●	106	126	dB	
CMRR	Input Common Mode Rejection Ratio	$V_{\text{CM}} = 0\text{V to } 3.25\text{V}$	●	90	126	dB	
		$V_{\text{CM}} = 5\text{V to } 76\text{V}$	●	120	140	dB	
$V_{\text{OL}}$	Output Voltage Swing Low	$V_S = 5\text{V}$ , No Load $V_S = 5\text{V}$ , $I_{\text{SINK}} = 5\text{mA}$	● ●		3 280	75 550	mV mV
$V_{\text{OH}}$	Output Voltage Swing High	$V_S = 5\text{V}$ , No Load $V_S = 5\text{V}$ , $I_{\text{SOURCE}} = 5\text{mA}$	● ●		450 1000	750 1300	mV mV
$I_{\text{SC}}$	Short-Circuit Current	$V_S = 5\text{V}$ , $50\Omega$ to $V^+$	●	8	25	mA	
		$V_S = 5\text{V}$ , $50\Omega$ to $V^-$	●	8	25	mA	
GBW	Gain Bandwidth Product	$f_{\text{TEST}} = 100\text{kHz}$	●	2.85	3.2	MHz	
			●	2.4	3.2	MHz	
SR	Slew Rate	$\Delta V_{\text{OUT}} = 3\text{V}$	●	0.55	0.75	$\text{V}/\mu\text{s}$	
			●	0.4	0.75	$\text{V}/\mu\text{s}$	
$t_s$	Settling Time Due to Input Step	0.1% Settling $\Delta V_{\text{OUT}} = \pm 2\text{V}$			3.5	$\mu\text{s}$	
$V_S$	Supply Voltage		●	3		50	V
	Reverse Supply (Note 7)	$I_S < -25\mu\text{A}/\text{Amplifier}$	●	3.3	-63	-50	V
$I_S$	Supply Current Per Amplifier	SOT-23 Package MS8, DJC22 Packages	●		315	345	$\mu\text{A}$
			●		315	335	$\mu\text{A}$
			●		315	540	$\mu\text{A}$
$R_O$	Output Impedance	$\Delta I_O = \pm 5\text{mA}$			0.15	$\Omega$	

The ● denotes the specifications which apply over the specified temperature range,  $-55^{\circ}\text{C} < T_{\text{JUNCTION}} < 150^{\circ}\text{C}$  for MP-grade parts, otherwise specifications are at  $T_A = 25^{\circ}\text{C}$ ,  $V_S = \pm 15\text{V}$ ,  $V_{\text{CM}} = V_{\text{OUT}} = \text{mid-supply}$ .

SYMBOL	PARAMETER	CONDITIONS	MP-GRADE			UNITS	
			MIN	TYP	MAX		
$V_{\text{OSI}}$	Input Offset Voltage	$V_S = \pm 25\text{V}$ $V_S = \pm 25\text{V}$	●	-80	$\pm 55$	80	$\mu\text{V}$
			●	-500	$\pm 55$	500	$\mu\text{V}$
			●	-110	$\pm 75$	110	$\mu\text{V}$
			●	-500	$\pm 75$	500	$\mu\text{V}$
$\frac{\Delta V_{\text{OSI}}}{\Delta \text{TEMP}}$	Input Offset Voltage Drift			0.75		$\mu\text{V}/^{\circ}\text{C}$	
$I_B$	Input Bias Current		●	-5	$\pm 2$	5	nA
			●	-300	$\pm 2$	300	nA
$I_{\text{OS}}$	Input Offset Current		●	-5	$\pm 2$	5	nA
			●	-50	$\pm 2$	50	nA
VCMR	Common Mode Input Range		●	-15		61	V
$C_{\text{IN}}$	Differential Input Capacitance				5	pF	
$R_{\text{IN}}$	Differential Input Resistance	$0 < V_{\text{CM}} < V^+ - 1.75\text{V}$ $V_{\text{CM}} > V^+$			1		M $\Omega$
					3.7		k $\Omega$

601567ff

**ELECTRICAL CHARACTERISTICS** The ● denotes the specifications which apply over the specified temperature range,  $-55^{\circ}\text{C} < T_{\text{JUNCTION}} < 150^{\circ}\text{C}$  for MP-grade parts, otherwise specifications are at  $T_A = 25^{\circ}\text{C}$ ,  $V_S = \pm 15\text{V}$ ,  $V_{\text{CM}} = V_{\text{OUT}} = \text{Mid-Supply}$ .

SYMBOL	PARAMETER	CONDITIONS	MP-GRADE			UNITS	
			MIN	TYP	MAX		
$R_{\text{INCM}}$	Common Mode Input Resistance	$0 < V_{\text{CM}} < V^+ - 1.75\text{V}$ $V_{\text{CM}} > V^+$		>1 >100		$\text{G}\Omega$ $\text{M}\Omega$	
$e_n$	Input Referred Noise Voltage Density	$f = 1\text{kHz}$ $V_{\text{CM}} < V^+ - 1.75\text{V}$ $V_{\text{CM}} > V^+$		18 25		$\text{nV}/\sqrt{\text{Hz}}$ $\text{nV}/\sqrt{\text{Hz}}$	
	Input Referred Noise Voltage	$f = 0.1\text{Hz to } 10\text{Hz}$ $V_{\text{CM}} < V^+ - 1.75\text{V}$		0.5		$\mu\text{V}_{\text{P-P}}$	
$i_n$	Input Referred Noise Current Density	$f = 1\text{kHz}$ $V_{\text{CM}} < V^+ - 1.75\text{V}$ $V_{\text{CM}} > V^+$		0.1 11.5		$\text{pA}/\sqrt{\text{Hz}}$ $\text{pA}/\sqrt{\text{Hz}}$	
	Open Loop Gain	$R_L = 10\text{k}\Omega$ $\Delta V_{\text{OUT}} = 27\text{V}$	●	100	1000	$\text{V}/\text{mV}$	
PSRR	Supply Rejection Ratio	$V_S = \pm 2.5\text{V to } \pm 25\text{V}$ $V_{\text{CM}} = V_{\text{OUT}} = 0\text{V}$	●	106	126	dB	
CMRR	Input Common Mode Rejection Ratio	$V_{\text{CM}} = -15\text{V to } 13.25\text{V}$	●	100	126	dB	
$V_{\text{OL}}$	Output Voltage Swing Low	$V_S = \pm 15\text{V}$ , No Load $V_S = \pm 15\text{V}$ , $I_{\text{SINK}} = 5\text{mA}$	● ●	3 280	75 550	$\text{mV}$ $\text{mV}$	
	Output Voltage Swing High	$V_S = \pm 15\text{V}$ , No Load $V_S = \pm 15\text{V}$ , $I_{\text{SOURCE}} = 5\text{mA}$	● ●	450 1000	750 1300	$\text{mV}$ $\text{mV}$	
$I_{\text{SC}}$	Short-Circuit Current	$V_S = \pm 15\text{V}$ , $50\Omega$ to GND $V_S = \pm 15\text{V}$ , $50\Omega$ to GND	● ●	8 8	30 32	$\text{mA}$ $\text{mA}$	
	Gain Bandwidth Product	$f_{\text{TEST}} = 100\text{kHz}$	●	2.9 2.45	3.3 3.3	$\text{MHz}$ $\text{MHz}$	
SR	Slew Rate	$\Delta V_{\text{OUT}} = 3\text{V}$	●	0.6 0.45	0.8 0.8	$\text{V}/\mu\text{s}$ $\text{V}/\mu\text{s}$	
$t_s$	Settling Time Due to Input Step	0.1% Settling $\Delta V_{\text{OUT}} = \pm 2\text{V}$			3.5	$\mu\text{s}$	
$V_S$	Supply Voltage		● ●	3 3.3	50 50	$\text{V}$ $\text{V}$	
	Reverse Supply	$I_S = -25\mu\text{A}/\text{Amplifier}$	●	-65	-30	$\text{V}$	
$I_S$	Supply Current Per Amplifier	SOT-23 Package			325	360	$\mu\text{A}$
		MS8, DJC22 Packages			325	350	$\mu\text{A}$
			●		325	575	$\mu\text{A}$
		$V_S = \pm 25\text{V}$ , SOT-23 Package			340	370	$\mu\text{A}$
		$V_S = \pm 25\text{V}$ , MS8, DJC22 Package $V_S = \pm 25\text{V}$	●		340 340	360 600	$\mu\text{A}$ $\mu\text{A}$
$R_O$	Output Impedance	$\Delta I_O = \pm 5\text{mA}$			0.15	$\Omega$	

**Note 1:** Stresses beyond those listed under Absolute Maximum Ratings may cause permanent damage to the device. Exposure to any Absolute Maximum Rating condition for extended periods may affect device reliability and lifetime.

**Note 2:** Voltages applied are with respect to  $V^-$ . The inputs are tested to the Absolute Maximum Rating by applying  $-25\text{V}$  (relative to  $V^-$ ) to each input for 10ms. In general, faults capable of sinking current from either input should be current limited to under 10mA. See the Applications Information section for more details.

**Note 3:** A heat sink may be required to keep the junction temperature below absolute maximum. This depends on the power supply voltage and how many amplifiers are shorted.

**Note 4:** The LT6015/LT6016/LT6017 are guaranteed functional over the operating temperature range of  $-40^{\circ}\text{C}$  to  $85^{\circ}\text{C}$ . The LT6015H/LT6016H/LT6017H are guaranteed functional over the operating temperature range of  $-40^{\circ}\text{C}$  to  $125^{\circ}\text{C}$ .

The LT6015MP/LT6016MP/LT6017MP are guaranteed functional over the junction temperature range of  $-55^{\circ}\text{C}$  to  $150^{\circ}\text{C}$ . Junction temperatures greater than  $125^{\circ}\text{C}$  will promote accelerated aging. The LT6015/LT6016/LT6017 has a demonstrated typical performance beyond 1000 hours at  $T_J = 150^{\circ}\text{C}$ .

**Note 5:** The LT6015/LT6016/LT6017 are guaranteed to meet specified performance from  $-40^{\circ}\text{C}$  to  $85^{\circ}\text{C}$ . The LT6015H/LT6016H/LT6017H are guaranteed to meet specified performance from  $-40^{\circ}\text{C}$  to  $125^{\circ}\text{C}$ . The LT6015MP/LT6016MP/LT6017MP are guaranteed to meet specified performance with junction temperature ranging from  $-55^{\circ}\text{C}$  to  $150^{\circ}\text{C}$ .

**Note 6:** Test accuracy is limited by high speed test equipment repeatability. Bench measurements indicate the input offset current in the Over-The-Top configuration is typically controlled to under  $\pm 50\text{nA}$  at  $25^{\circ}\text{C}$  and  $\pm 150\text{nA}$  over temperature.

**Note 7:** The Reverse Supply voltage is tested by pulling  $25\mu\text{A}/\text{Amplifier}$  out of the  $V^+$  pin while measuring the  $V^+$  pin's voltage with both inputs and  $V^-$  grounded, verifying  $V^+ < -50\text{V}$ .

TYPICAL PERFORMANCE CHARACTERISTICS

Typical Distribution of Input Offset Voltage

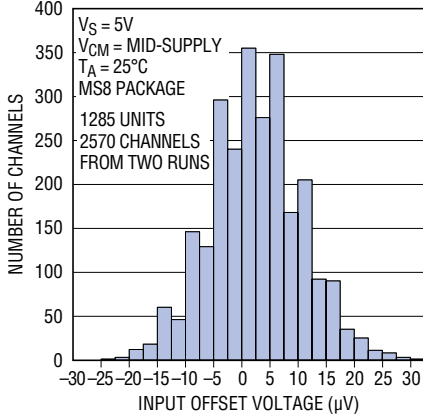

601567 G01

Typical Distribution of Input Offset Voltage

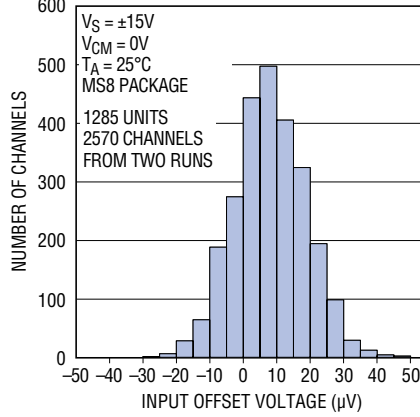

601567 G02

Typical Distribution of Over-The-Top Input Offset Voltage

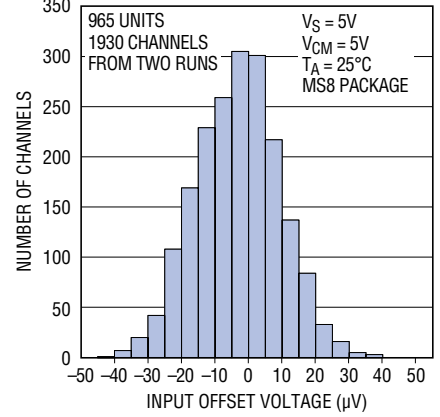

601567 G03

Typical Distribution of Over-The-Top Input Offset Voltage

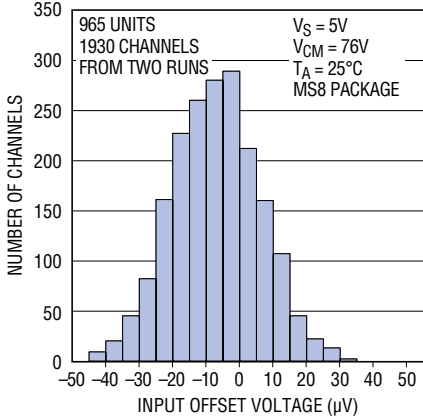

601567 G04

Typical Distribution of Input Offset Voltage

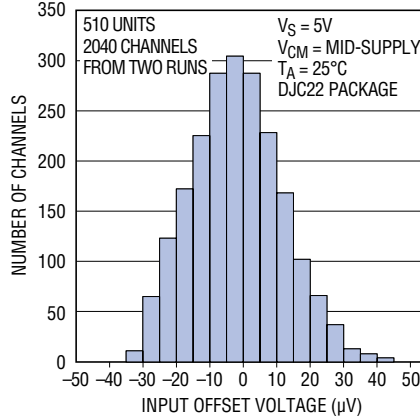

601567 G05

Typical Distribution of Over-The-Top Input Offset Voltage

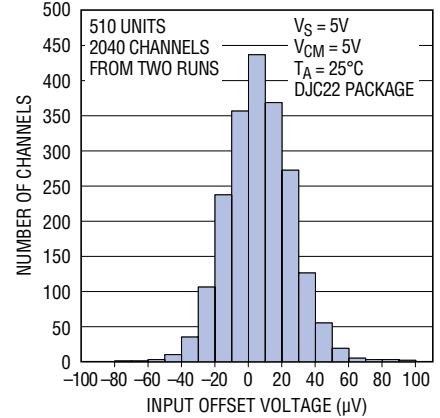

601567 G06

Voltage Offset Shift vs Lead Free IR Reflow

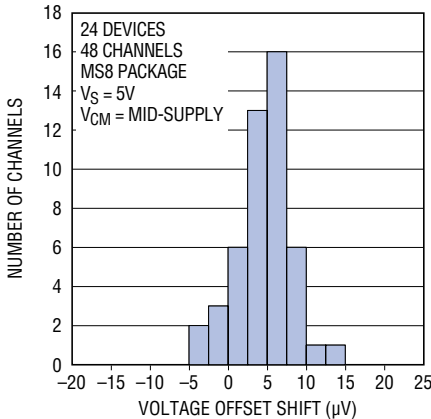

601567 G07

Over-The-Top Voltage Offset Shift vs Lead Free IR Reflow

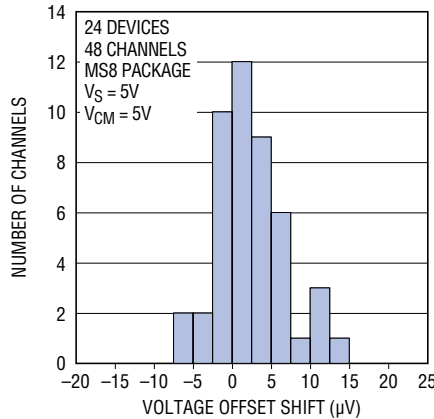

601567 G08

Voltage Offset Shift vs Lead Free IR Reflow

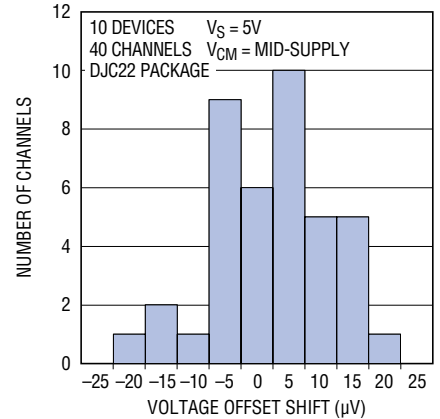

601567 G09



# TYPICAL PERFORMANCE CHARACTERISTICS

**Warm-Up Drift**

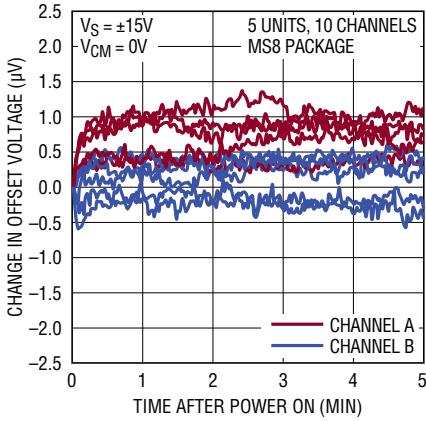

601567 G10

**Over-The-Top Warm-Up Drift**

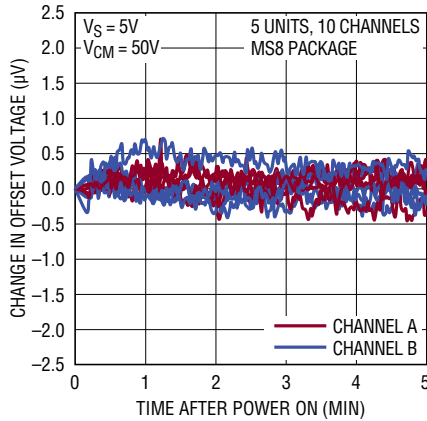

601567 G11

**Voltage Offset Shift vs Thermal Cycling**

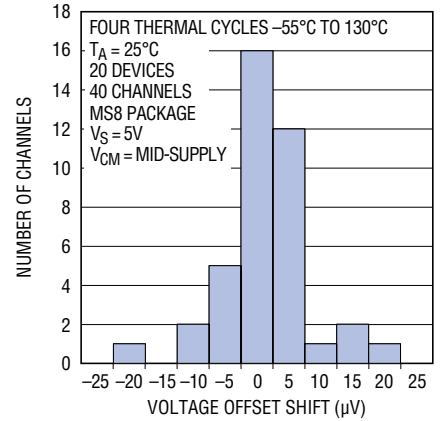

601567 G12

**Voltage Offset Shift vs Temperature Cycling**

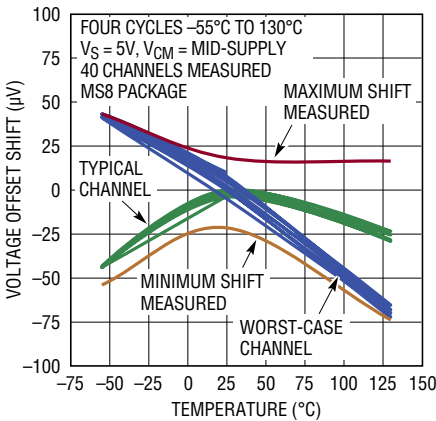

601567 G13

**Voltage Offset vs Temperature**

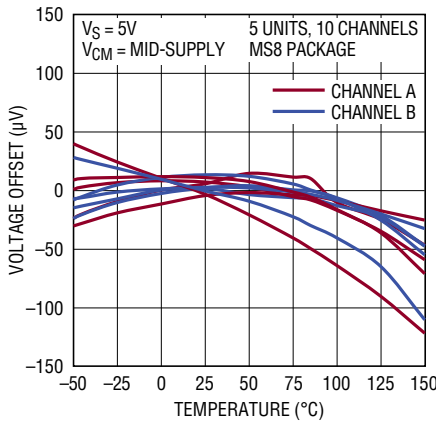

601567 G14

**Over-The-Top Voltage Offset vs Temperature**

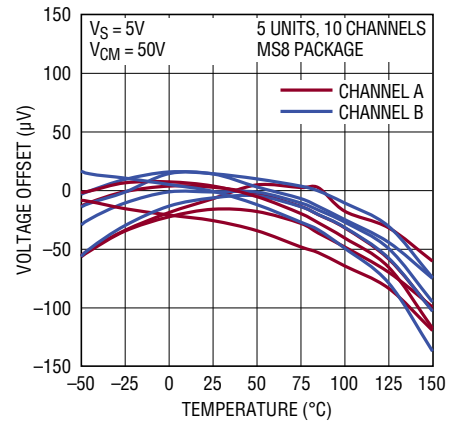

601567 G15

**Voltage Offset vs Input Common Mode Voltage**

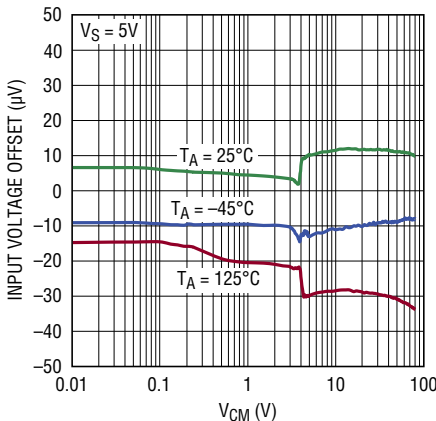

601567 G16

**Voltage Offset vs Supply Voltage**

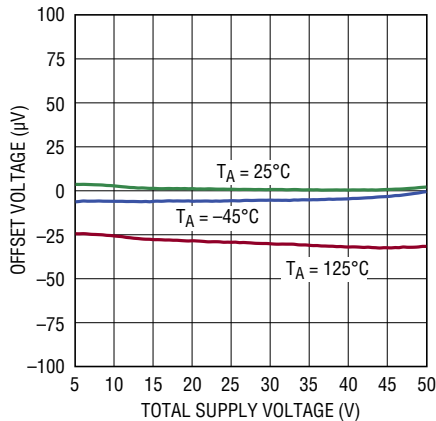

601567 G17

**Minimum Supply Voltage**

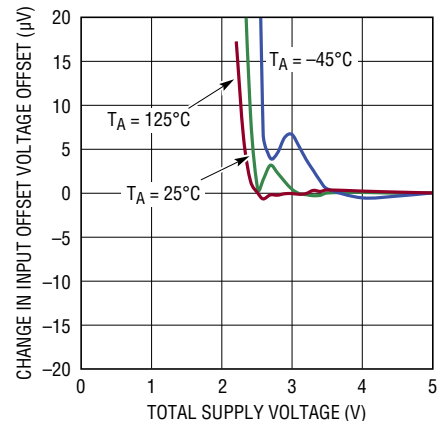

601567 G18

**TYPICAL PERFORMANCE CHARACTERISTICS**

**Long Term Stability of Five Representative Units**

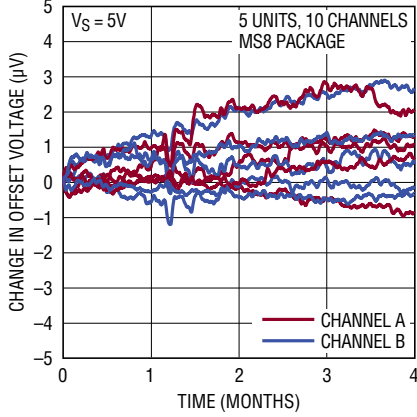

601567 G19

**Input Bias Current vs Input Common Mode Voltage**

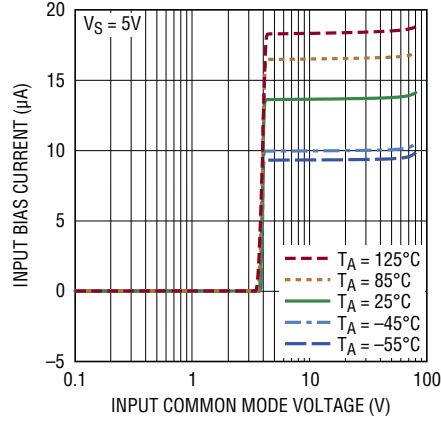

601567 G20

**Input Bias Current vs Input Common Mode Voltage**

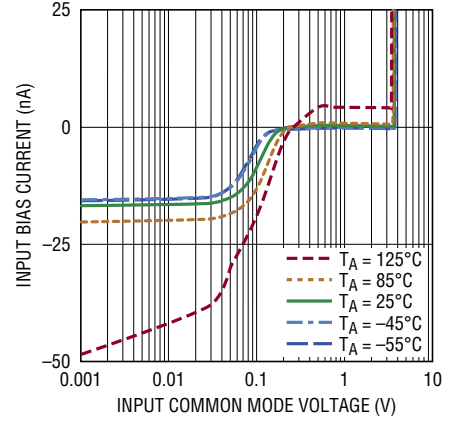

601567 G21

**Input Bias Current vs Supply Voltage**

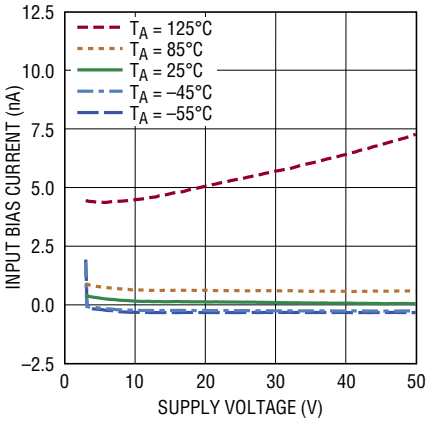

601567 G22

**Supply Current vs Supply Voltage**

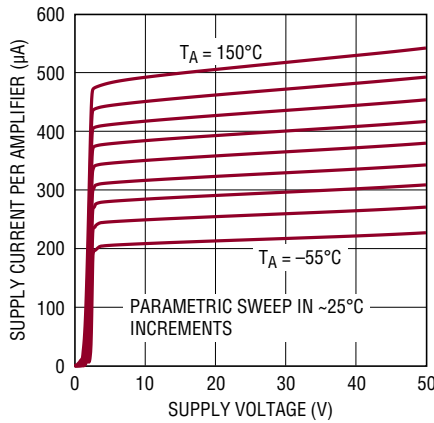

601567 G23

**Reverse Supply Current vs Reverse Supply Voltage**

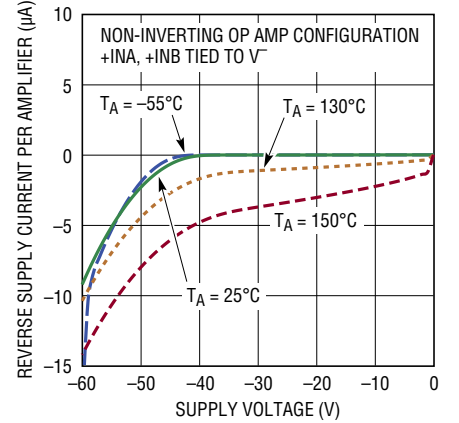

601567 G24

**Noise Density vs Frequency**

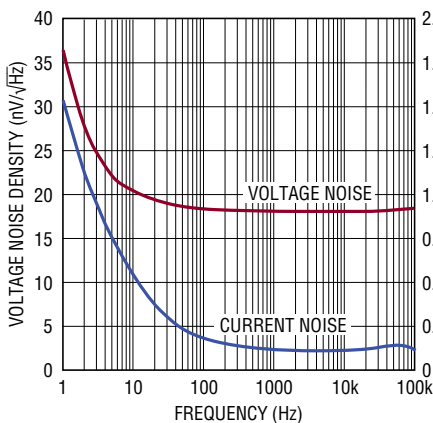

601567 G25

**Over-The-Top Noise Density vs Frequency**

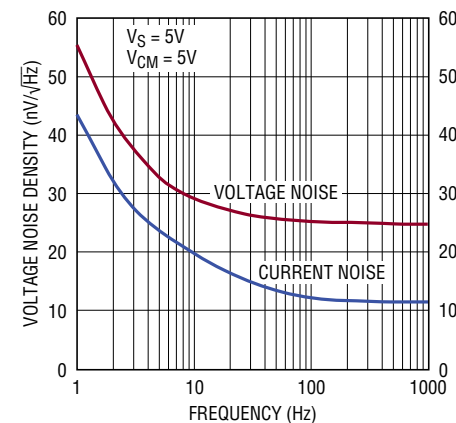

601567 G26

**0.1Hz to 10Hz Noise**

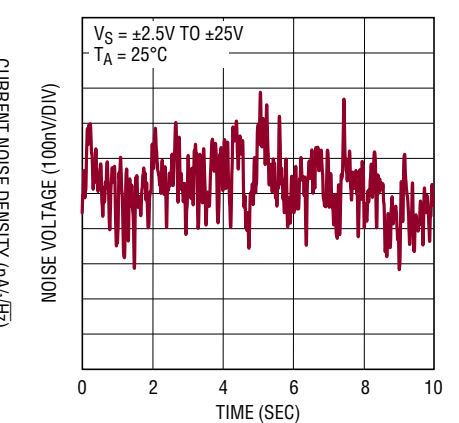

601567 G27

601567ff

# TYPICAL PERFORMANCE CHARACTERISTICS

**Output Impedance vs Frequency**

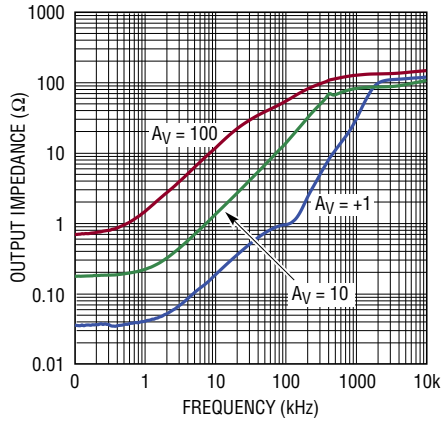

601567 G28

**PSRR vs Frequency**

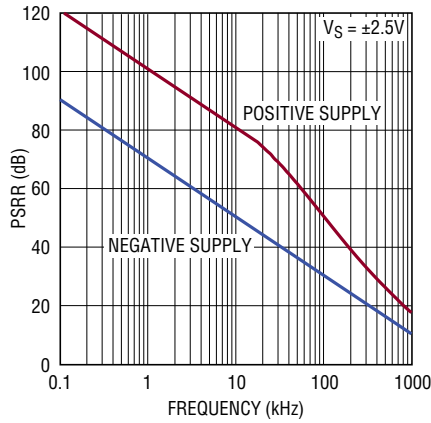

601567 G29

**CMRR vs Frequency**

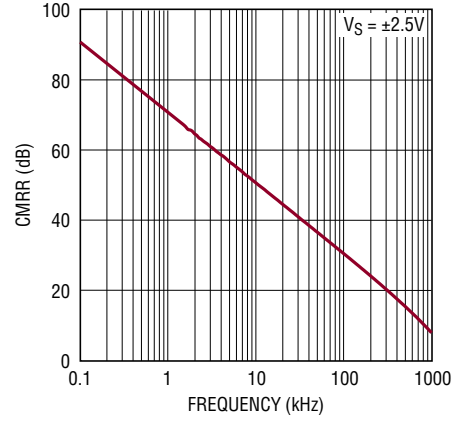

601567 G30

**Closed-Loop Small Signal Frequency Response**

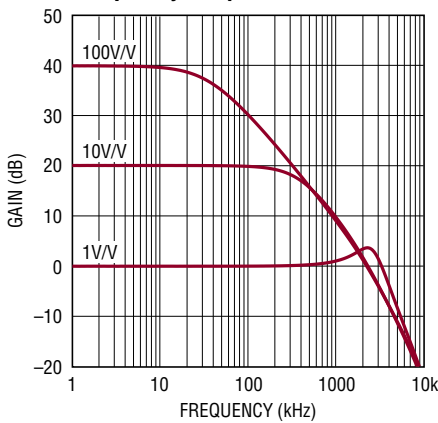

601567 G31

**Gain and Phase Shift vs Frequency**

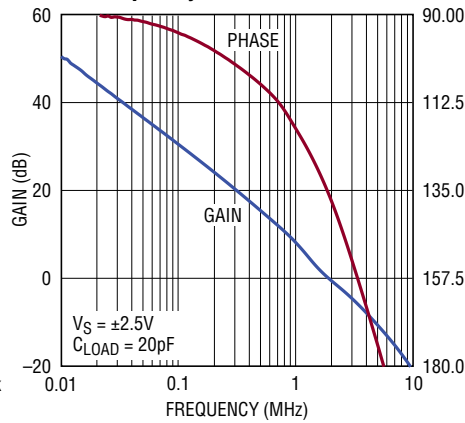

601567 G32

**Gain Bandwidth Product and Phase Margin vs Supply Voltage**

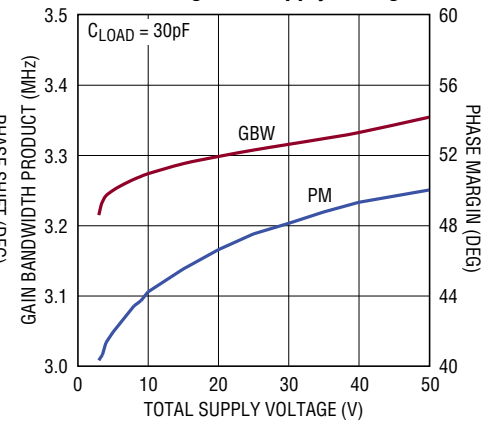

601567 G33

**Phase Margin vs Capacitive Load**

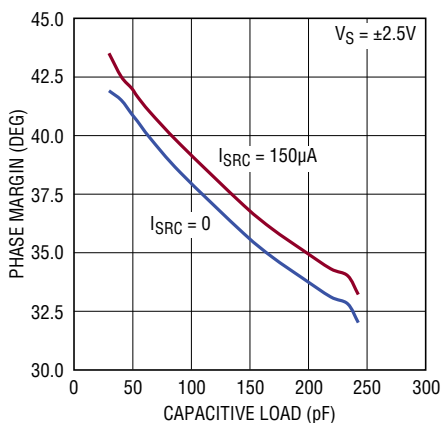

601567 G34

**Gain-Bandwidth vs Temperature**

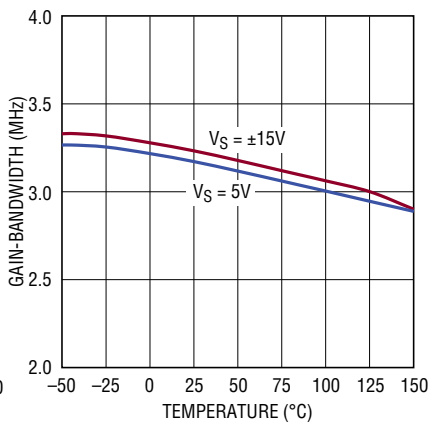

601567 G35

**Channel Separation vs Frequency**

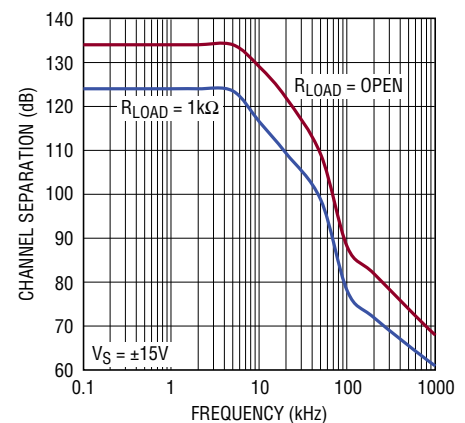

601567 G36

## TYPICAL PERFORMANCE CHARACTERISTICS

**Settling Time to 0.1% vs Output Step**

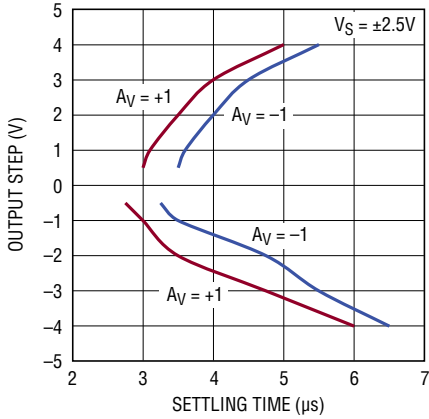

601567 G37

**Slew Rate vs Temperature**

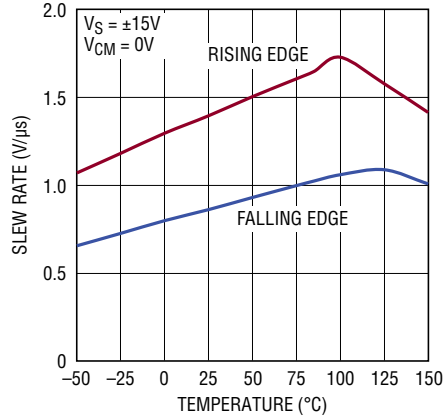

601567 G38

**Short-Circuit vs Temperature**

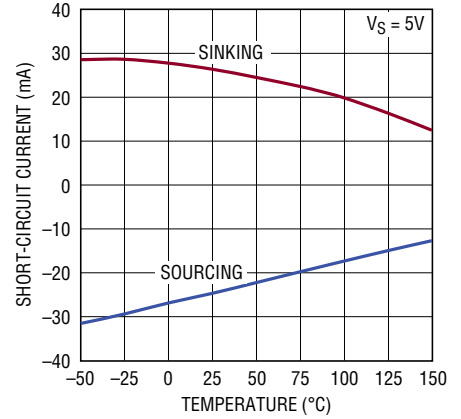

601567 G39

**Small Signal Transient Response**

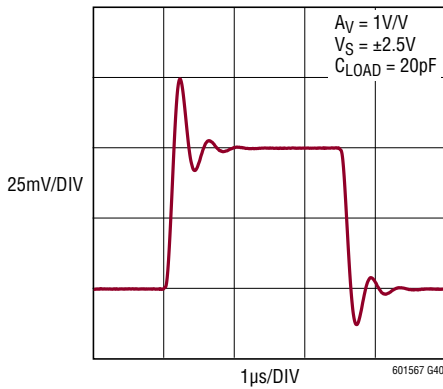

601567 G40

**Large Signal Transient Response**

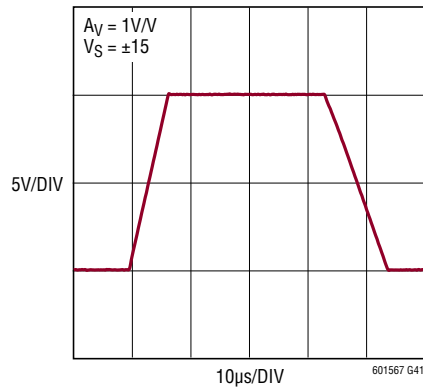

601567 G41

**Output Saturation Voltage vs Input Overdrive**

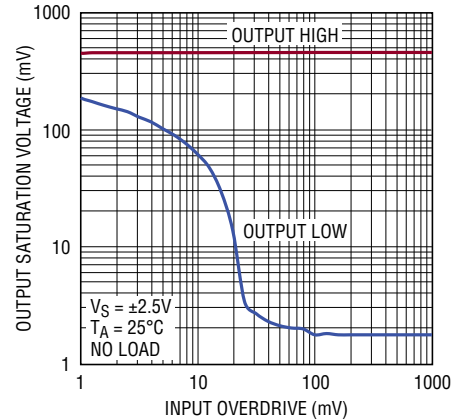

601567 G42

**Output Saturation Voltage (VOL) vs Load Current**

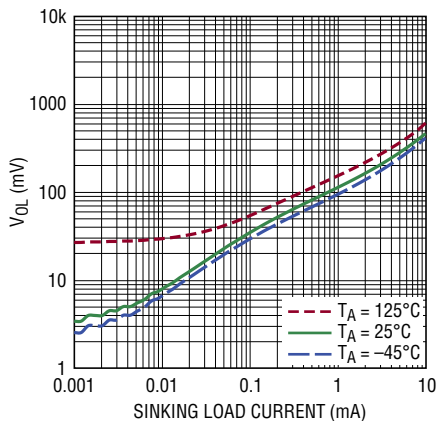

601567 G43

**Output Saturation Voltage (VOH) vs Load Current**

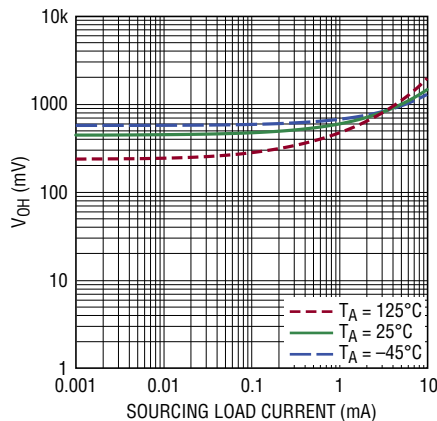

601567 G44

**Open-Loop Gain**

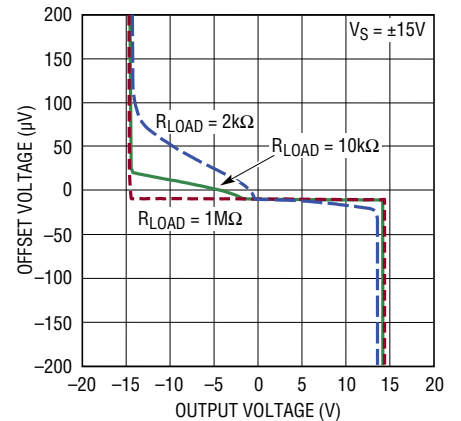

601567 G45

## APPLICATIONS INFORMATION

### Supply Voltage

The positive supply pin of the LT6015/LT6016/LT6017 should be bypassed with a small capacitor (typically 0.1 $\mu$ F) as close to the supply pins as possible. When driving heavy loads an additional 4.7 $\mu$ F electrolytic capacitor should be added. When using split supplies, the same is true for the  $V^-$  supply pin.

The LT6017 consists of two dual amplifier dice assembled in a single DFN package which share a common substrate ( $V^-$ ). While the  $V^-$  pins of the quad (pins 16 and 18) must always be tied together and to the exposed pad underneath, the  $V^+$  power supply pins (pins 5 and 7) may be supplied independently. The B and C channel amplifiers are supplied through  $V^+$  by pin 7, and the A and D channel amplifiers are supplied by pin 5. If pin 5 and pin 7 are not tied together and are biased independently, each  $V^+$  pin should have their own dedicated supply bypass to ground.

### Shutdown

While there are no dedicated shutdown pins for the LT6015/LT6016/LT6017, the amplifiers can effectively be shut down into a low power state by removing  $V^+$ . In this condition the input bias current is typically less than 1nA with the inputs biased between  $V^-$  and 76V above  $V^-$ , and if the inputs are taken below  $V^-$ , they appear as a diode in series with 1k of resistance. The output may be pulled up to 50V above the  $V^+$  power supply in this condition (See Figure 1). Pulling the output pin below  $V^-$  will produce unlimited current and can damage the part.

### Reverse Battery

The LT6015/LT6016/LT6017 are protected against reverse battery voltages up to 50V. In the event a reverse battery condition occurs, the supply current is typically less than 5 $\mu$ A (assuming the inputs are biased within a diode drop from  $V^-$ ). For typical single supply applications with ground referred loads and feedback networks, no other precautions are required. If the reverse battery condition results in a negative voltage at the input pins, the current into the pin should be limited by an external resistor to less than 10mA.

### Inputs

Referring to the Simplified Schematic, the LT6015/LT6016/LT6017 has two input stages: a common emitter differential input stage consisting of PNP transistors Q1 and Q2 which operate when the inputs are biased between  $V^-$  and 1.5V below  $V^+$ , and a common base input stage consisting of PNP transistors Q3 to Q6 which operate when the common mode input is biased greater than  $V^+ - 1.5V$ . This results in two distinct operating regions as shown in Figure 2.

For common mode input voltages approximately 1.5V or more below the  $V^+$  supply (Q1 and Q2 active), the common emitter PNP input stage is active and the input bias current is typically under  $\pm 2nA$ . When the common mode input is within approximately 1V of the  $V^+$  supply or higher

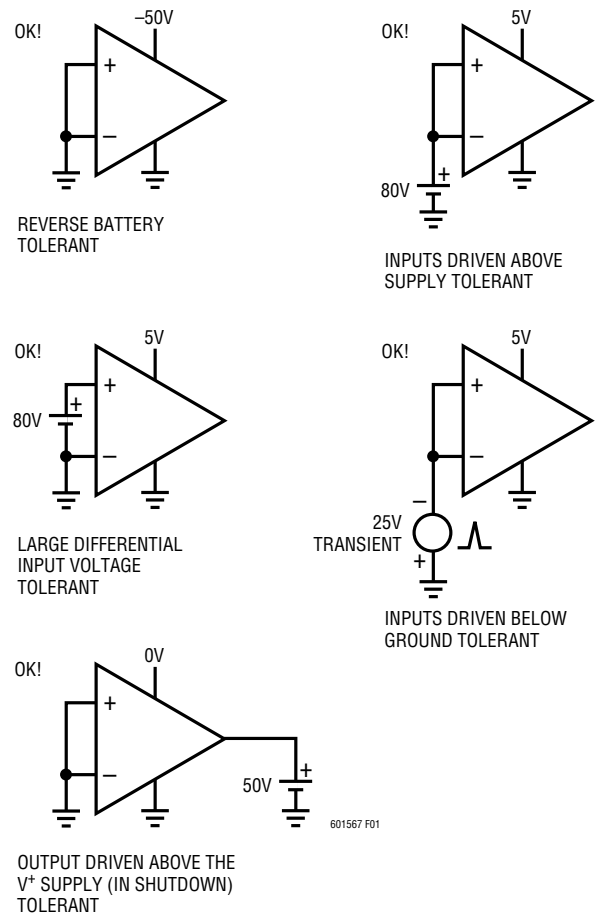

Figure 1. LT6015/LT6016/LT6017 Fault Tolerant Conditions

## APPLICATIONS INFORMATION

(Over-The-Top operation), Q9 begins to turn on diverting bias current away from the common emitter differential input pair to the current mirror consisting of Q11 and Q12. The current from Q12 will bias the common base differential input pair consisting of Q3 to Q6. Because the Over-The-Top input pair is operating in a common base configuration, the input bias current will increase to about 14 $\mu$ A. Both input stages have their voltage offsets trimmed tightly and are specified in the Electrical Characteristics table.

The inputs are protected against temporary excursions to as much as 25V below  $V^-$  by internal 1k resistor in series with each input and a diode from the input to the negative supply. Adding additional external series resistance will extend the protection beyond 25V below  $V^-$ . The input stage of the LT6015/LT6016/LT6017 incorporates phase reversal protection to prevent the output from phase reversing for inputs below  $V^-$ .

There are no clamping diodes between the inputs. The inputs may be over-driven differentially to 80V without damage, or without drawing appreciable input current. Figure 1 summarizes the kind of faults that may be applied to the LT6015/LT6016/LT6017 without damage.

### Over-The-Top Operation Considerations

When the input common mode of the LT6015/LT6016/LT6017 is biased near or above the  $V^+$  supply, the amplifier is said to be operating in the Over-The-Top configuration. The differential input pair which control amplifier operation is common base pair Q3 to Q6 (refer to the Simplified Schematic). If the input common mode is biased between  $V^-$  and approximately 1.5V below  $V^+$ , the amplifier is said to be operating in the normal configuration. The differential input pair which control amplifier operation is common emitter pair Q1 and Q2.

A plot of the Over-The-Top Transition region vs Temperature (the region between normal operation and Over-The-Top operation) on a 5V single supply is shown in Figure 2.

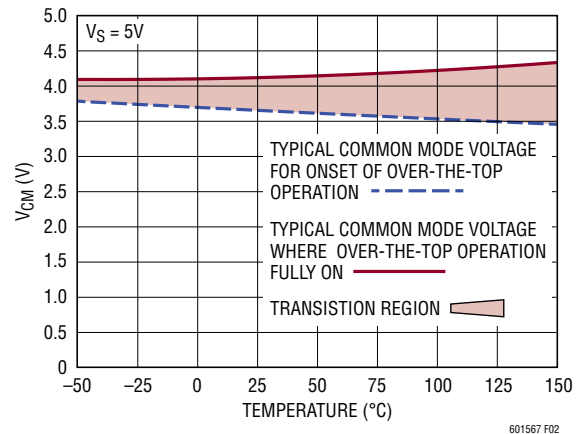

**Figure 2. LT6016/LT6017 Over-The-Top Transition Region vs Temperature**

Some implications should be understood about Over-The-Top operation. The first, and most obvious is the input bias currents change from under  $\pm 2$ nA in normal operation to 14 $\mu$ A in Over-The-Top operation as the input stage transitions from common emitter to common base. Even though the Over-The-Top input bias currents run around 14  $\mu$ A, they are very well matched and their offset is typically under  $\pm 100$ nA.

The second and more subtle change to amplifier operation is the differential input impedance which decreases from 1M $\Omega$  in normal operation, to approximately 3.7k $\Omega$  in Over-The-Top operation (specified as  $R_{IN}$  in the Electrical Characteristics table). This resistance appears across the summing nodes in Over-The-Top operation and is due to the common base input stage configuration. Its value is easily derived from the specified input bias current flowing into the op amp inputs and is equal to  $2 \cdot k \cdot T / (q \cdot I_b)$  ( $k$ -Boltzmann's constant,  $T$  – operating temperature,  $I_b$ -operating input bias current of the amplifier in the Over-The-Top region). And because the inputs are biased proportional to absolute temperature, it is relatively constant with temperature. The user may think this effective resistance is relatively harmless because it appears across the summing nodes which are forced

## APPLICATIONS INFORMATION

to 0V differential by feedback action of the amplifier. However, depending on the configuration of the feedback around the amplifier, this input resistance can boost noise gain, lower overall amplifier loop gain and closed loop bandwidth, raise output noise, with one benevolent effect in increasing amplifier stability.

In the normal mode of operation (where  $V^- < V_{CM} < V^+$   $-1.5V$ ),  $R_{IN}$  is typically large compared to the value of the input resistor used, and  $R_{IN}$  can be ignored (refer to Figure 3). In this case the noise gain is defined by the equation:

$$\text{NOISE GAIN} \approx 1 + \frac{R_F}{R_I}$$

However, when the amplifier transitions into Over-The-Top mode with the input common mode biased near or above the  $V^+$  supply,  $R_{IN}$  should be considered. The noise gain of the amplifier changes to:

$$\text{NOISE GAIN} = 1 + \frac{R_F}{R_I \parallel (R_{IN} + R_I \parallel R_F)}$$

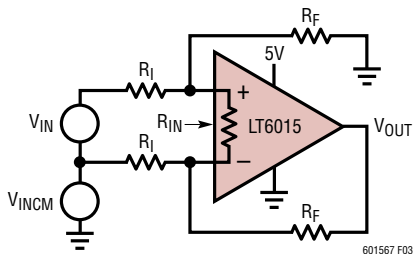

**Figure 3. Difference Amplifier Configured for Both Normal and Over-The-Top Operation**

While it is true that the DC closed loop gain will remain mostly unaffected ( $= \frac{R_F}{R_I}$ ), the loop gain of the amplifier

has decreased from  $\frac{A_{OL}}{1 + \frac{R_F}{R_I}}$  to  $\frac{A_{OL}}{1 + \frac{R_F}{R_I \parallel (R_{IN} + R_I \parallel R_F)}}$

Likewise the closed loop bandwidth of the amplifier will change going from normal mode operation to Over-The-Top operation:

$$\text{Normal mode: } BW_{\text{CLOSED-LOOP}} \approx \frac{GBW}{1 + \frac{R_F}{R_I}}$$

Over-The-Top mode:

$$BW_{\text{CLOSED-LOOP}} \approx \frac{GBW}{1 + \frac{R_F}{R_I \parallel (R_{IN} + R_I \parallel R_F)}}$$

And output noise is negatively impacted going from normal mode to Over-The-Top:

Normal mode: (neglecting resistor noise)

$$e_{no} \approx e_{ni} \cdot \left( 1 + \frac{R_F}{R_I} \right)$$

Over-The-Top mode: (neglecting resistor noise)

$$e_{no} \approx e_{ni} \cdot \left( 1 + \frac{R_F}{R_I \parallel (R_{IN} + R_I \parallel R_F)} \right)$$

### Output

The output of the LT6015/LT6016/LT6017 can swing within a Schottky diode drop ( $\sim 0.4V$ ) of the  $V^+$  supply, and within 5mV of the negative supply with no load. The output is capable of sourcing and sinking approximately 25mA.

The LT6015/LT6016/LT6017 are internally compensated to drive at least 200pF of capacitance under any output loading conditions. For larger capacitive loads, a 0.22μF capacitor in series with a 150Ω resistor between the output and ground will compensate these amplifiers to drive capacitive loads greater than 200pF.

## APPLICATIONS INFORMATION

### Distortion

There are two main contributors of distortion in op amps: output crossover distortion as the output transitions from sourcing to sinking current and distortion caused by nonlinear common mode rejection. If the op amp is operating in an inverting configuration there is no common mode induced distortion. If the op amp is operating in the noninverting configuration within the normal input common mode range ( $V^-$  to  $V^+ - 1.5V$ ) the CMRR is very good, typically over 120dB. When the LT6015/LT6016/LT6017 transitions input stages going from the normal input stage to the Over-The-Top input stage or vice-versa, there will be a significant degradation in linearity due to the change in input circuitry.

Lower load resistance increases distortion due to a net decrease in loop gain, and greater voltage swings internal to the amp necessary to drive the load, but has no effect on the input stage transition distortion. The lowest distortion can be achieved with the LT6015/LT6016/LT6017 sourcing in class-A operation in an inverting configuration, with the input common mode biased mid-way between the supplies.

### Power Dissipation Considerations

Because of the ability of the LT6015/LT6016/LT6017 to operate on power supplies up to  $\pm 25V$  and to drive heavy loads, there is a need to ensure the die junction temperature does not exceed  $150^\circ C$ . The LT6015 is housed in a 5-lead TSOT-23 package ( $\theta_{JA} = 250^\circ C/W$ ). The LT6016 is housed in an 8-lead MSOP package ( $\theta_{JA} = 273^\circ C/W$ ). The LT6017 is housed in a 22 pin leadless DFN package (DJC22,  $\theta_{JA} = 31.8^\circ C/W$ ).

In general, the die junction temperature ( $T_J$ ) can be estimated from the ambient temperature  $T_A$ , and the device power dissipation  $P_D$ :

$$T_J = T_A + P_D \cdot \theta_{JA}$$

The power dissipation in the IC is a function of supply voltage and load resistance. For a given supply voltage, the worst-case power dissipation  $P_{D(MAX)}$  occurs at the maximum supply current with the output voltage at half of either supply voltage (or the maximum swing is less than one-half the supply voltage).  $P_{D(MAX)}$  is given by:

$$P_{D(MAX)} = (V_S \cdot I_{S(MAX)}) + (V_S/2)^2/R_{LOAD}$$

Example: An LT6016 in a MSOP package mounted on a PC board has a thermal resistance of  $273^\circ C/W$ . Operating on  $\pm 25V$  supplies with both amplifiers simultaneously driving  $2.5k\Omega$  loads, the worst-case IC power dissipation for the given load occurs when driving  $12.5V_{PEAK}$  and is given by:

$$P_{D(MAX)} = 2 \cdot 50 \cdot 0.6mA + 2 \cdot (12.5)^2/2500 = 0.185W$$

With a thermal resistance of  $273^\circ C/W$ , the die temperature will experience approximately a  $50^\circ C$  rise above ambient. This implies the maximum ambient temperature the LT6016 should ever operate under the assumed conditions:

$$T_A = 150^\circ C - 50^\circ C = 100^\circ C$$

To operate to higher ambient temperatures, use two channels of the LT6017 quad which has lower thermal resistance  $\theta_{JA} = 31.8^\circ C/W$ , and an exposed pad which may be soldered down to a copper plane (connected to  $V^-$ ) to further lower the thermal resistance below  $\theta_{JA} = 31.8^\circ C/W$ .



## SIMPLIFIED SCHEMATIC

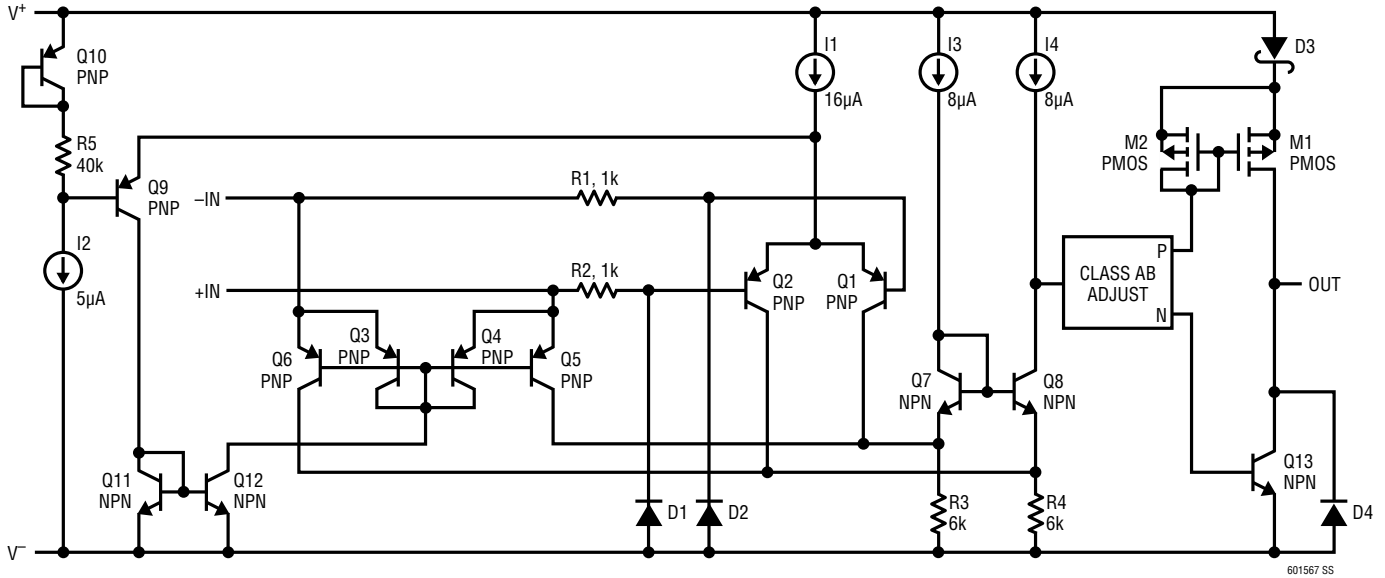

## TYPICAL APPLICATIONS

Gain of 100 High Voltage Difference Amplifier with  $-5V/75V$  Common Mode Range

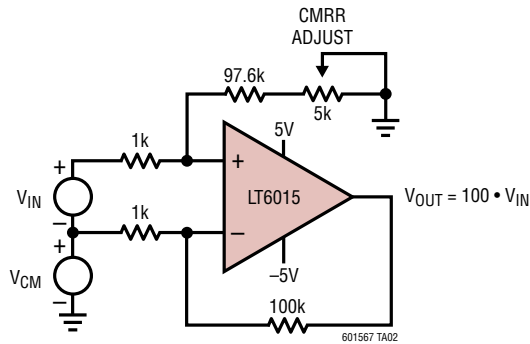

Wide Input Range Current Sense Amp Goes Hi-Z When  $V_{SUPPLY}$  Removed

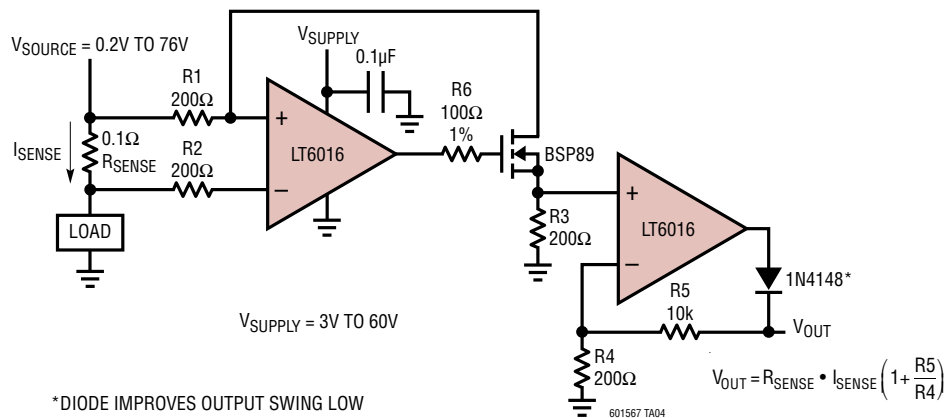

601567ff

## PACKAGE DESCRIPTION

Please refer to <http://www.linear.com/designtools/packaging/> for the most recent package drawings.

**DJC Package**  
**22-Lead Plastic DFN (6mm × 3mm)**  
 (Reference LTC DWG # 05-08-1714 Rev 0)

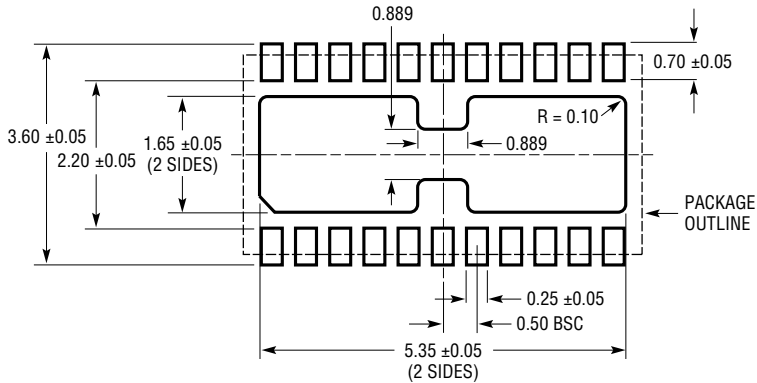

RECOMMENDED SOLDER PAD PITCH AND DIMENSIONS

NOTE:

1. DIMENSIONS ARE IN MILLIMETERS
2. APPLY SOLDER MASK TO AREAS THAT ARE NOT SOLDERED
3. DRAWING IS NOT TO SCALE

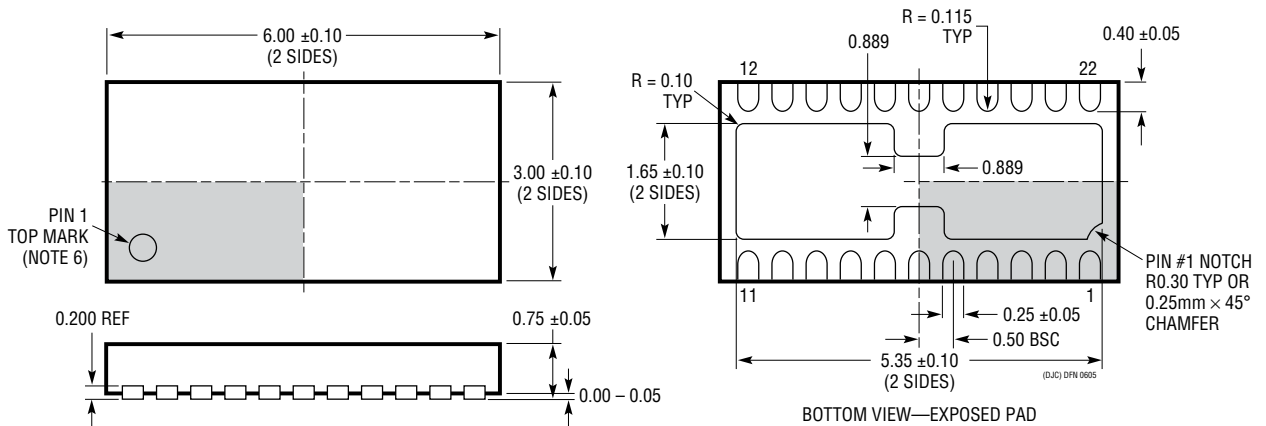

NOTE:

1. DRAWING PROPOSED TO BE MADE VARIATION OF VERSION (WXXX) IN JEDEC PACKAGE OUTLINE MO-229
2. DRAWING NOT TO SCALE
3. ALL DIMENSIONS ARE IN MILLIMETERS
4. DIMENSIONS OF EXPOSED PAD ON BOTTOM OF PACKAGE DO NOT INCLUDE MOLD FLASH. MOLD FLASH, IF PRESENT, SHALL NOT EXCEED 0.15mm ON ANY SIDE
5. EXPOSED PAD SHALL BE SOLDER PLATED
6. SHADED AREA IS ONLY A REFERENCE FOR PIN 1 LOCATION ON TOP AND BOTTOM OF PACKAGE

# PACKAGE DESCRIPTION

Please refer to <http://www.linear.com/designtools/packaging/> for the most recent package drawings.

## MS8 Package 8-Lead Plastic MSOP (Reference LTC DWG # 05-08-1660 Rev G)

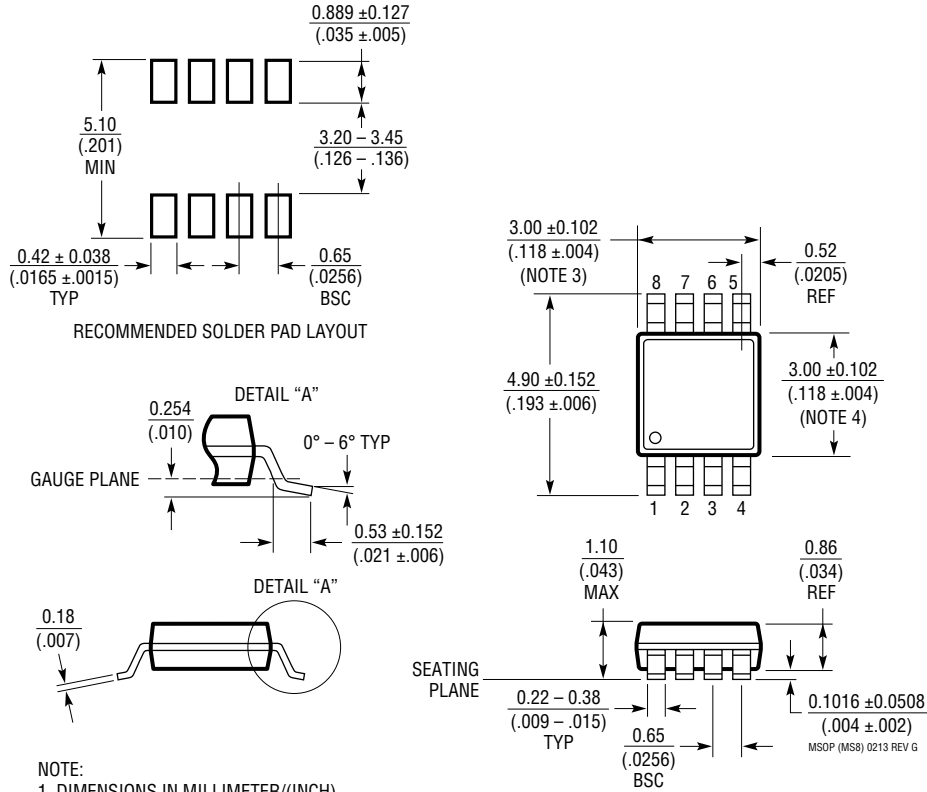

- NOTE:
1. DIMENSIONS IN MILLIMETER/(INCH)
  2. DRAWING NOT TO SCALE
  3. DIMENSION DOES NOT INCLUDE MOLD FLASH, PROTRUSIONS OR GATE BURRS.  
MOLD FLASH, PROTRUSIONS OR GATE BURRS SHALL NOT EXCEED 0.152mm (.006") PER SIDE
  4. DIMENSION DOES NOT INCLUDE INTERLEAD FLASH OR PROTRUSIONS.  
INTERLEAD FLASH OR PROTRUSIONS SHALL NOT EXCEED 0.152mm (.006") PER SIDE
  5. LEAD COPLANARITY (BOTTOM OF LEADS AFTER FORMING) SHALL BE 0.102mm (.004") MAX

## PACKAGE DESCRIPTION

Please refer to <http://www.linear.com/designtools/packaging/> for the most recent package drawings.

### S5 Package 5-Lead Plastic TSOT-23 (Reference LTC DWG # 05-08-1635)

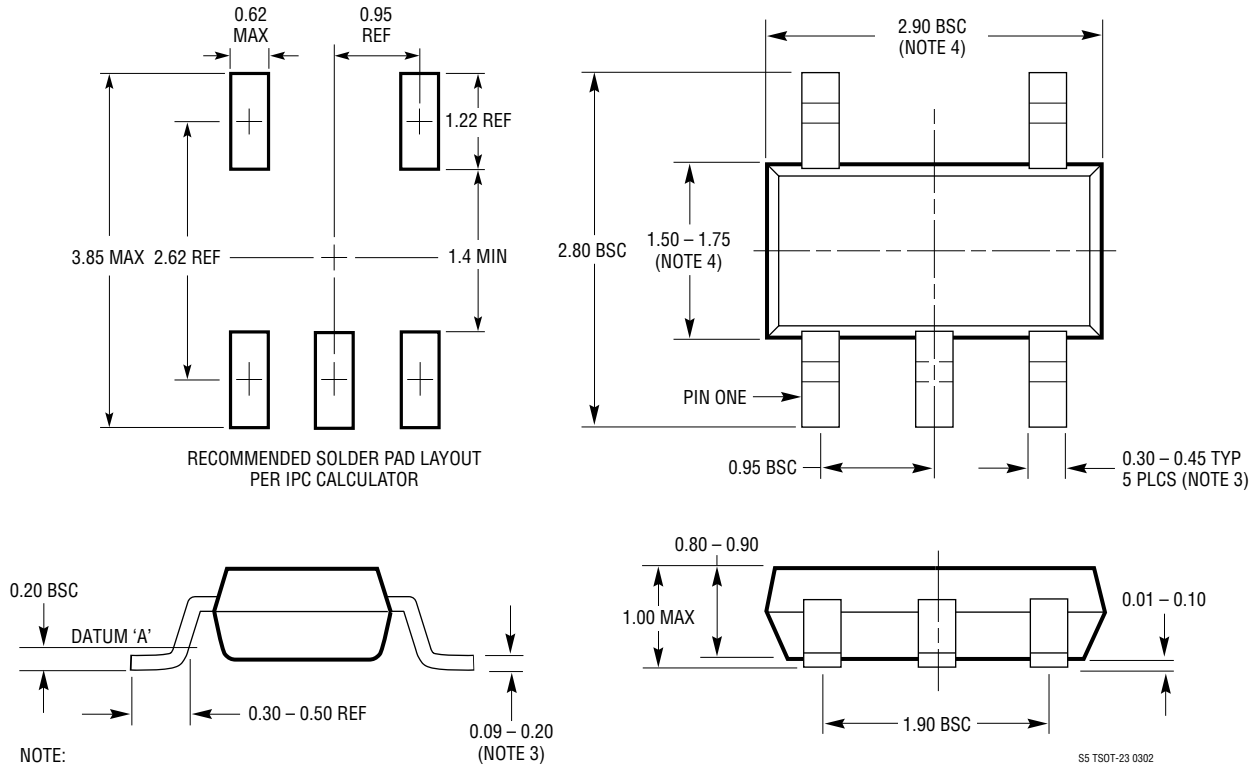

**NOTE:**

1. DIMENSIONS ARE IN MILLIMETERS
2. DRAWING NOT TO SCALE
3. DIMENSIONS ARE INCLUSIVE OF PLATING
4. DIMENSIONS ARE EXCLUSIVE OF MOLD FLASH AND METAL BURR
5. MOLD FLASH SHALL NOT EXCEED 0.254mm
6. JEDEC PACKAGE REFERENCE IS MO-193

## REVISION HISTORY

REV	DATE	DESCRIPTION	PAGE NUMBER
A	01/13	Corrected Block Diagram Q7 and Q8	17
B	06/13	Added LT6015 Single Amplifier Changed MIN $I_B$ at $V_{CM} = 0V$ to $-60nA$ , changed GBW test condition to $f_{TEST} = 100kHz$ Added Wide Input Range Current Sense Amp circuit	All 3-7 17
C	11/13	Revised Order Information table to include mini tape and reel for LT6015	2
D	12/13	Corrected quad pinout	2, 13
E	09/14	Corrected TSOT-23 part marking and package description	2
F	08/15	Corrected axis label on graph G32	11