

Tiny Micropower Precision Series References in 2mm × 2mm DFN

FEATURES

- No Output Capacitor Required
- Low Drift: 20ppm/°C Max
- High Accuracy: 0.2% Max
- Low Supply Current
- 20mA Output Current Guaranteed
- Reverse-Battery Protection
- Low IR Reflow Induced Stress: 0.02% Typ
- Voltage Options: 2.5V, 3V, 3.3V, 5V and 10V
- Space-Saving Alternative to the LT1460
- 3-Lead 2mm × 2mm × 0.75mm DFN Package

APPLICATIONS

- Handheld Instruments
- Precision Regulators
- A/D and D/A Converters
- Power Supplies
- Hard Disk Drives
- Sensor Modules

DESCRIPTION

The LT[®]6660 is a family of micropower series references that combine high accuracy and low drift with low power dissipation and extremely small package size. These series references use curvature compensation to obtain low temperature coefficient, and laser trimmed precision thin-film resistors to achieve high output accuracy. The LT6660 will supply up to 20mA with excellent line regulation characteristics, making it ideal for precision regulator applications.

The LT6660 family of series references provide supply current and power dissipation advantages over shunt references that must idle the entire load current to operate. Additionally, the LT6660 does not require an output compensation capacitor. This feature is important in applications where PC board space is a premium, fast settling is demanded, or total capacitance must be kept to a minimum, as in intrinsic safety applications. Reverse-battery protection keeps these references from conducting reverse current.

LT, LT, LTC and LTM are registered trademarks of Linear Technology Corporation. All other trademarks are the property of their respective owners.

TYPICAL APPLICATION

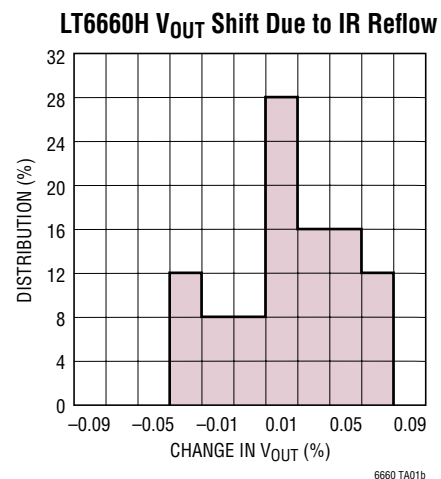
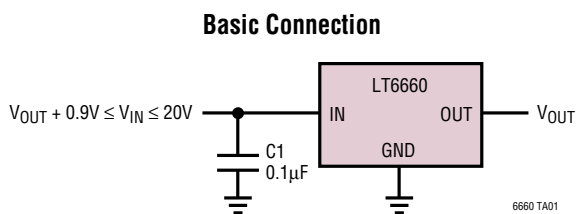

ABSOLUTE MAXIMUM RATINGS

(Note 1)

Input Voltage.....	30V	Operating Temperature Range	
Reverse Voltage	-15V	(Note 2)	-40°C to 85°C
Output Short-Circuit Duration, $T_A = 25^\circ\text{C}$	5 sec	Storage Temperature Range (Note 3).....	-65°C to 150°C
Specified Temperature Range	0°C to 70°C	Lead Temperature (Soldering, 10 sec)	300°C

PACKAGE/ORDER INFORMATION

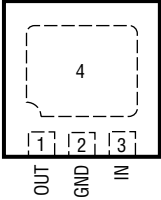
<p style="text-align: center;">TOP VIEW</p>  <p style="text-align: center;">DC PACKAGE 3-LEAD (2mm × 2mm) PLASTIC DFN $T_{JMAX} = 125^\circ\text{C}$, $\theta_{JA} = 102^\circ\text{C/W}$ EXPOSED PAD IS GND, MUST BE SOLDERED TO PCB</p>	ORDER PART NUMBER	DFN PART MARKING*
	LT6660HCDC-2.5	LBXN
	LT6660JCDC-2.5	LBXN
	LT6660KCDC-2.5	LBXN
	LT6660HCDC-3	LBYV
	LT6660JCDC-3	LBYV
	LT6660KCDC-3	LBYV
	LT6660HCDC-3.3	LBYW
	LT6660JCDC-3.3	LBYW
	LT6660KCDC-3.3	LBYW
	LT6660HCDC-5	LBYT
	LT6660JCDC-5	LBYT
	LT6660KCDC-5	LBYT
	LT6660HCDC-10	LBYX
	LT6660JCDC-10	LBYX
LT6660KCDC-10	LBYX	
<p>Order Options Tape and Reel: Add #TR Lead Free: Add #PBF Lead Free Tape and Reel: Add #TRPBF Lead Free Part Marking: http://www.linear.com/leadfree/</p>		

Consult LTC Marketing for parts specified with wider operating temperature ranges. *The temperature grade is identified by a label on the shipping container.

AVAILABLE OPTIONS

OUTPUT VOLTAGE (V)	SPECIFIED TEMPERATURE RANGE	ACCURACY (%)	TEMPERATURE COEFFICIENT (ppm/°C)	PART ORDER NUMBER
2.5	0°C to 70°C	0.2	20	LT6660HCDC-2.5
2.5	0°C to 70°C	0.4	20	LT6660JCDC-2.5
2.5	0°C to 70°C	0.5	50	LT6660KCDC-2.5
3	0°C to 70°C	0.2	20	LT6660HCDC-3
3	0°C to 70°C	0.4	20	LT6660JCDC-3
3	0°C to 70°C	0.5	50	LT6660KCDC-3
3.3	0°C to 70°C	0.2	20	LT6660HCDC-3.3
3.3	0°C to 70°C	0.4	20	LT6660JCDC-3.3
3.3	0°C to 70°C	0.5	50	LT6660KCDC-3.3

AVAILABLE OPTIONS

OUTPUT VOLTAGE (V)	SPECIFIED TEMPERATURE RANGE	ACCURACY (%)	TEMPERATURE COEFFICIENT (ppm/°C)	PART ORDER NUMBER
5	0°C to 70°C	0.2	20	LT6660HCDC-5
5	0°C to 70°C	0.4	20	LT6660JCDC-5
5	0°C to 70°C	0.5	50	LT6660KCDC-5
10	0°C to 70°C	0.2	20	LT6660HCDC-10
10	0°C to 70°C	0.4	20	LT6660JCDC-10
10	0°C to 70°C	0.5	50	LT6660KCDC-10

ELECTRICAL CHARACTERISTICS

The ● denotes the specifications which apply over the full operating temperature range, otherwise specifications are at $T_A = 25^\circ\text{C}$. $V_{IN} = V_{OUT} + 2.5\text{V}$, $I_{OUT} = 0$ unless otherwise specified.

PARAMETER	CONDITIONS	MIN	TYP	MAX	UNITS
Output Voltage Tolerance	LT6660HCDC	-0.2		0.2	%
	LT6660JCDC	-0.4		0.4	%
	LT6660KCDC	-0.5		0.5	%
Output Voltage Temperature Coefficient (Note 4)	LT6660HCDC ●		10	20	ppm/°C
	LT6660JCDC ●		10	20	ppm/°C
	LT6660KCDC ●		25	50	ppm/°C
Line Regulation	$V_{OUT} + 0.9\text{V} \leq V_{IN} \leq V_{OUT} + 2.5\text{V}$ ●		150	800 1000	ppm/V ppm/V
	$V_{OUT} + 2.5\text{V} \leq V_{IN} \leq 20\text{V}$ ●		50	100 130	ppm/V ppm/V
Load Regulation Sourcing (Note 5)	$I_{OUT} = 100\mu\text{A}$ ●		1000	3000 4000	ppm/mA ppm/mA
	$I_{OUT} = 10\text{mA}$ ●		50	200 300	ppm/mA ppm/mA
	$I_{OUT} = 20\text{mA}$ ●		20	70 100	ppm/mA ppm/mA
Thermal Regulation (Note 6)	$\Delta P = 200\text{mW}$		2.5	10	ppm/mW
Dropout Voltage (Note 7)	$V_{IN} - V_{OUT}$, $\Delta V_{OUT} \leq 0.2\%$, $I_{OUT} = 0$ ●			0.9	V
	$V_{IN} - V_{OUT}$, $\Delta V_{OUT} \leq 0.2\%$, $I_{OUT} = 10\text{mA}$ ●			1.3 1.4	V V
Output Current	Short V_{OUT} to GND		40		mA
Reverse Leakage	$V_{IN} = -15\text{V}$ ●		0.5	10	μA
Output Voltage Noise (Note 8)	$0.1\text{Hz} \leq f \leq 10\text{Hz}$		4		ppm (P-P)
	$10\text{Hz} \leq f \leq 1\text{kHz}$		4		ppm (RMS)
Long-Term Stability of Output Voltage (Note 9)			100		ppm/ $\sqrt{\text{kHr}}$
Hysteresis (Note 10)	$\Delta T = 0^\circ\text{C}$ to 70°C ●		50		ppm
	$\Delta T = -40^\circ\text{C}$ to 85°C ●		250		ppm
Supply Current	LT6660-2.5 ●		115	145 175	μA μA
	LT6660-3 ●		145	180 220	μA μA
	LT6660-3.3 ●		145	180 220	μA μA
	LT6660-5 ●		160	200 240	μA μA
	LT6660-10 ●		215	270 350	μA μA

ELECTRICAL CHARACTERISTICS

Note 1: Stresses beyond those listed under Absolute Maximum Ratings may cause permanent damage to the device. Exposure to any Absolute Maximum Rating condition for extended periods may affect device reliability and lifetime.

Note 2: The LT6660 is guaranteed functional over the operating temperature range of -40°C to 85°C .

Note 3: If the parts are stored outside of the specified temperature range, the output may shift due to hysteresis.

Note 4: Temperature coefficient is measured by dividing the change in output voltage by the specified temperature range. Incremental slope is also measured at 25°C .

Note 5: Load regulation is measured on a pulse basis from no load to the specified load current. Output changes due to die temperature change must be taken into account separately.

Note 6: Thermal regulation is caused by die temperature gradients created by load current or input voltage changes. This effect must be added to normal line or load regulation. This parameter is not 100% tested.

Note 7: Excludes load regulation errors.

Note 8: Peak-to-peak noise is measured with a single pole highpass filter at 0.1Hz and 2-pole lowpass filter at 10Hz. The unit is enclosed in a still-air environment to eliminate thermocouple effects on the leads. The test time

is 10 sec. RMS noise is measured with a single pole highpass filter at 10Hz and a 2-pole lowpass filter at 1kHz. The resulting output is full wave rectified and then integrated for a fixed period, making the final reading an average as opposed to RMS. A correction factor of 1.1 is used to convert from average to RMS and a second correction of 0.88 is used to correct for the nonideal bandpass of the filters.

Note 9: Long-term stability typically has a logarithmic characteristic and therefore, changes after 1000 hours tend to be much smaller than before that time. Total drift in the second thousand hours is normally less than one third that of the first thousand hours with a continuing trend toward reduced drift with time. Long-term stability will also be affected by differential stresses between the IC and the board material created during board assembly.

Note 10: Hysteresis in output voltage is created by package stress that differs depending on whether the IC was previously at a higher or lower temperature. Output voltage is always measured at 25°C , but the IC is cycled to 70°C or 0°C before successive measurements. Hysteresis is roughly proportional to the square of the temperature change. For instruments that are stored at well-controlled temperatures (within 20 or 30 degrees of operational temperature) hysteresis is not a problem.

TYPICAL PERFORMANCE CHARACTERISTICS

Characteristic curves are similar for all voltage options of the LT6660. Curves from the LT6660-2.5 and the LT6660-10 represent the extremes of the voltage options. Characteristic curves for other output voltages fall between these curves, and can be estimated based on their voltage output.

2.5V Minimum Input-Output Voltage Differential

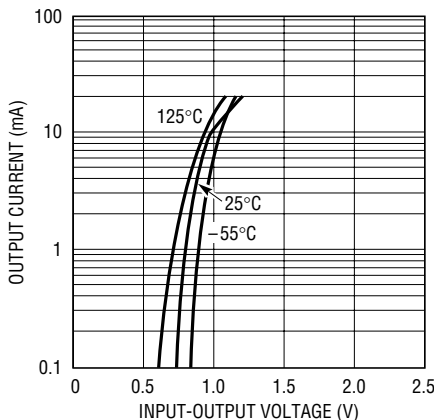

6660 G01

2.5V Load Regulation, Sourcing

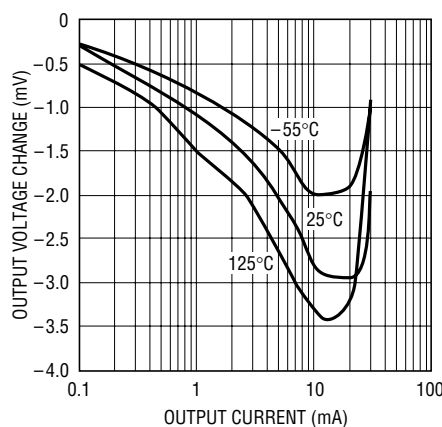

6660 G02

2.5V Load Regulation, Sinking

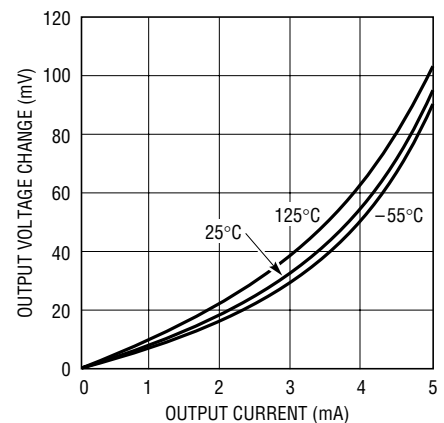

6660 G03

TYPICAL PERFORMANCE CHARACTERISTICS Characteristic curves are similar for all voltage options of the LT6660. Curves from the LT6660-2.5 and the LT6660-10 represent the extremes of the voltage options. Characteristic curves for other output voltages fall between these curves, and can be estimated based on their voltage output.

2.5V Output Voltage Temperature Drift

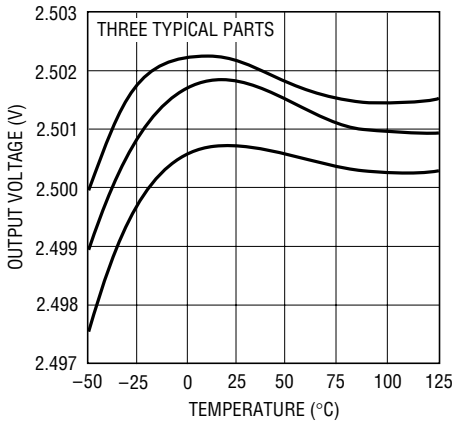

6660 G04

2.5V Supply Current vs Input Voltage

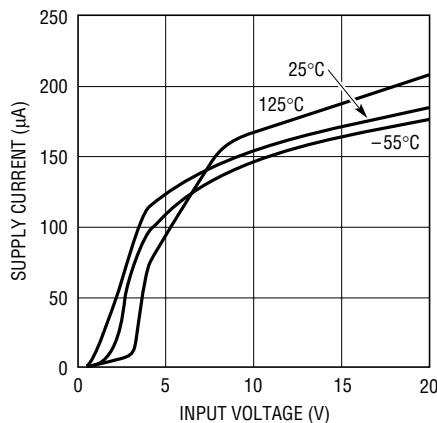

6660 G05

2.5V Line Regulation

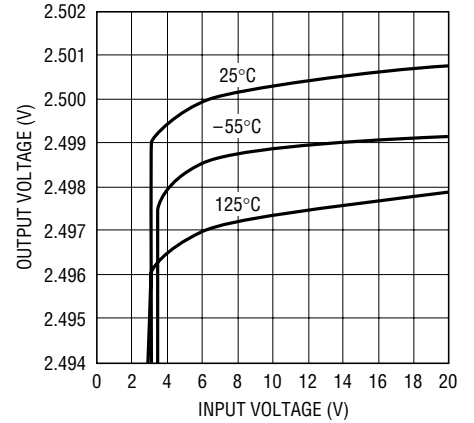

6660 G06

2.5V Power Supply Rejection Ratio vs Frequency

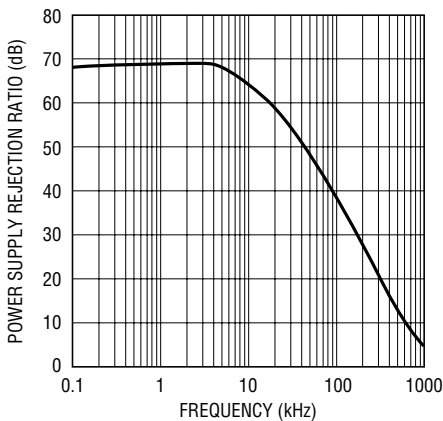

6660 G07

2.5V Output Impedance vs Frequency

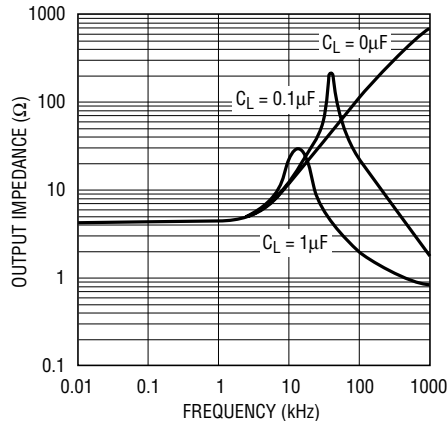

6660 G08

2.5V Transient Response

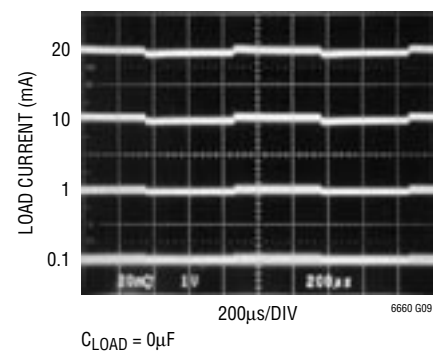

6660 G09

2.5V Output Voltage Noise Spectrum

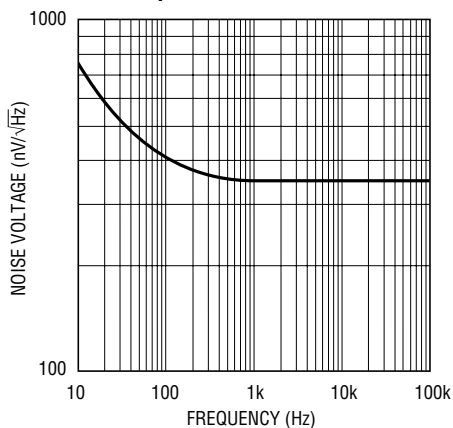

6660 G10

2.5V Output Noise 0.1Hz to 10Hz

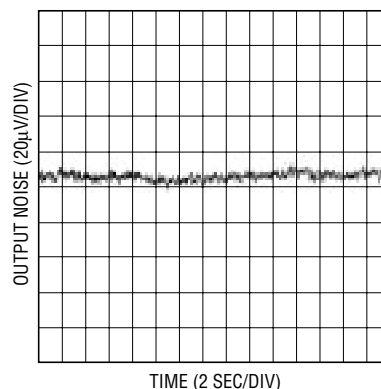

6660 G11

TYPICAL PERFORMANCE CHARACTERISTICS

Characteristic curves are similar for all voltage options of the LT6660. Curves from the LT6660-2.5 and the LT6660-10 represent the extremes of the voltage options. Characteristic curves for other output voltages fall between these curves, and can be estimated based on their voltage output.

10V Minimum Input-Output Voltage Differential

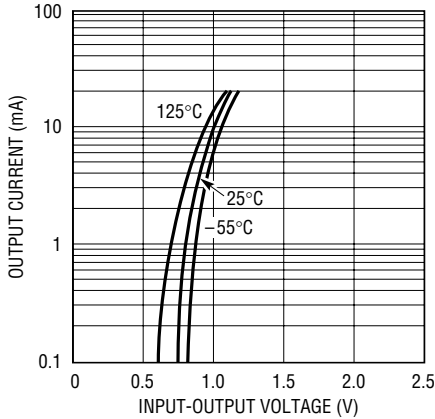

6660 G12

10V Load Regulation, Sourcing

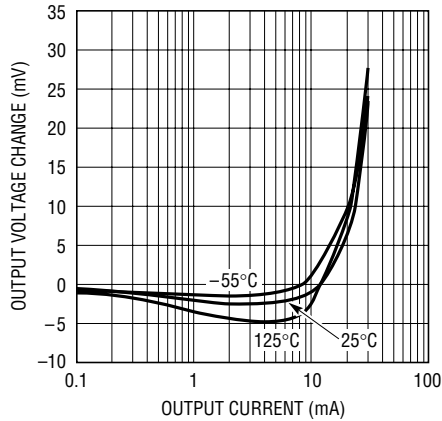

6660 G13

10V Load Regulation, Sinking

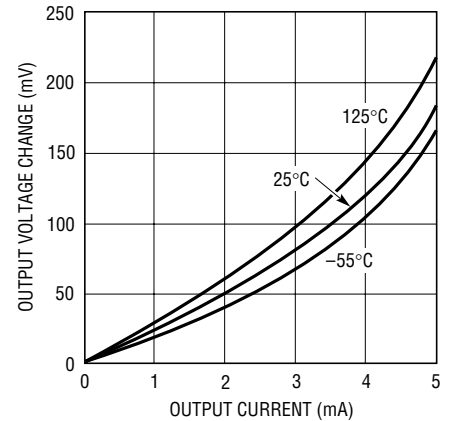

6660 G14

10V Output Voltage Temperature Drift

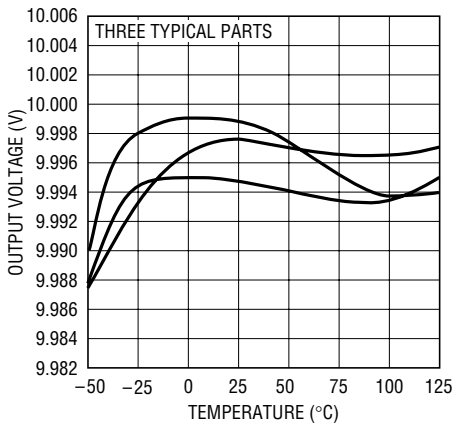

6660 G15

10V Supply Current vs Input Voltage

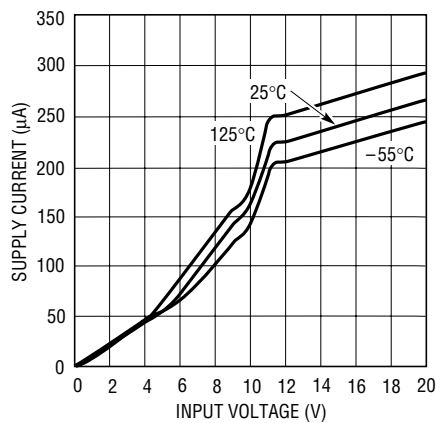

6660 G16

10V Line Regulation

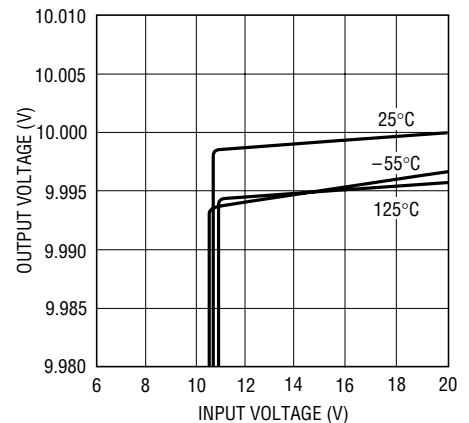

6660 G17

TYPICAL PERFORMANCE CHARACTERISTICS Characteristic curves are similar for all voltage options of the LT6660. Curves from the LT6660-2.5 and the LT6660-10 represent the extremes of the voltage options. Characteristic curves for other output voltages fall between these curves, and can be estimated based on their voltage output.

10V Power Supply Rejection Ratio vs Frequency

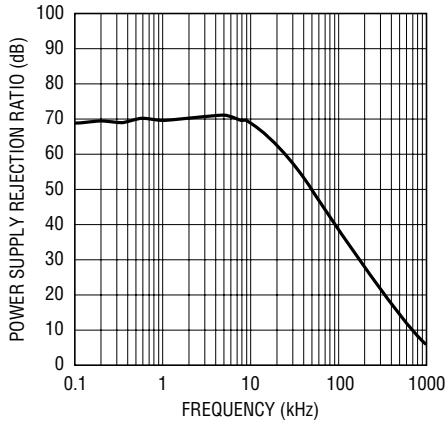

10V Output Impedance vs Frequency

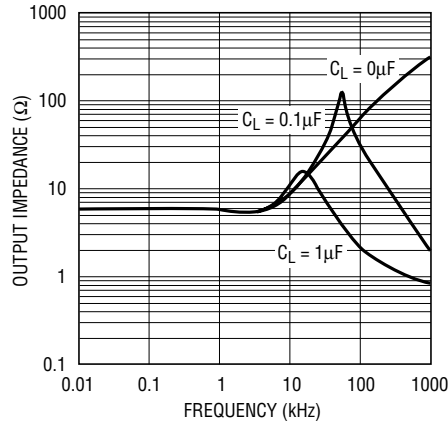

10V Transient Response

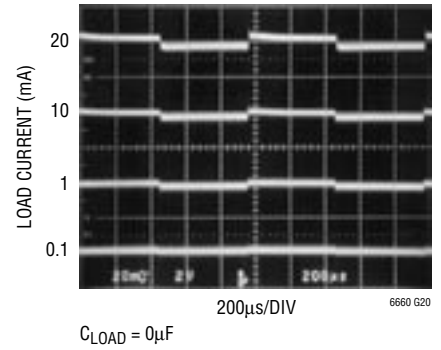

10V Output Voltage Noise Spectrum

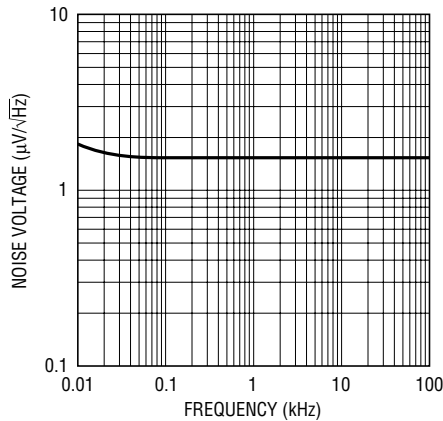

10V Output Noise 0.1Hz to 10Hz

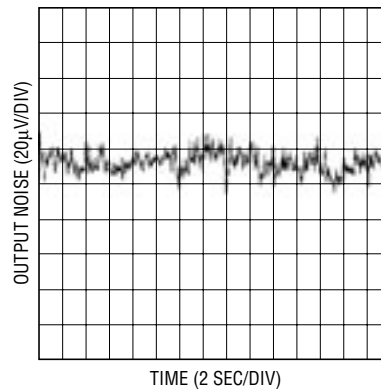

APPLICATIONS INFORMATION

Longer Battery Life

Series references have a large advantage over older shunt style references. Shunt references require a resistor from the power supply to operate. This resistor must be chosen to supply the maximum current that can ever be demanded by the circuit being regulated. When the circuit being controlled is not operating at this maximum current, the shunt reference must always sink this current, resulting in high dissipation and short battery life.

The LT6660 series references do not require a current setting resistor and can operate with any supply voltage from $V_{OUT} + 0.9V$ to 20V. When the circuitry being regulated does not demand current, the LT6660s reduce their dissipation and battery life is extended. If the references are not delivering load current, they dissipate only several mW, yet the same connection can deliver 20mA of load current when demanded.

Capacitive Loads

The LT6660 family of references are designed to be stable with a large range of capacitive loads. With no capacitive load, these references are ideal for fast settling or applications where PC board space is a premium. The test circuit shown in Figure 1 is used to measure the response time and stability of various load currents and load capacitors. This circuit is set for the 2.5V option. For other voltage options, the input voltage must be scaled up and the output voltage generator offset voltage must be adjusted. The 1V step from 2.5V to 1.5V produces a current step of 10mA or 1mA for $R_L = 100\Omega$ or $R_L = 1k$. Figure 2 shows the response of the reference to these 1mA and 10mA load steps with no load capacitance, and Figure 3 shows a 1mA and 10mA load step with a 0.1 μF output capacitor. Figure 4 shows the response to a 1mA load step with $C_L = 1\mu F$ and 4.7 μF .

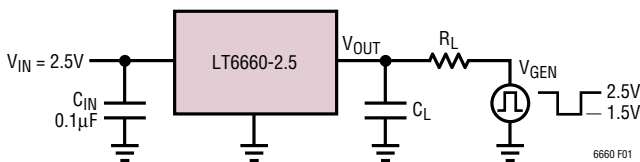

Figure 1. Response Time Test Circuit

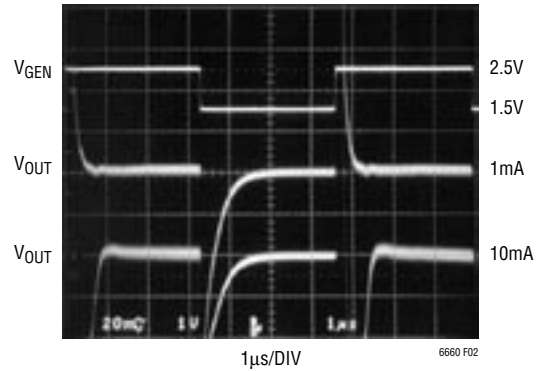

Figure 2. $C_L = 0\mu F$

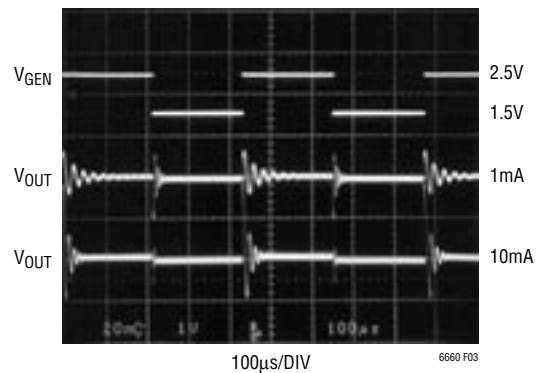

Figure 3. $C_L = 0.1\mu F$

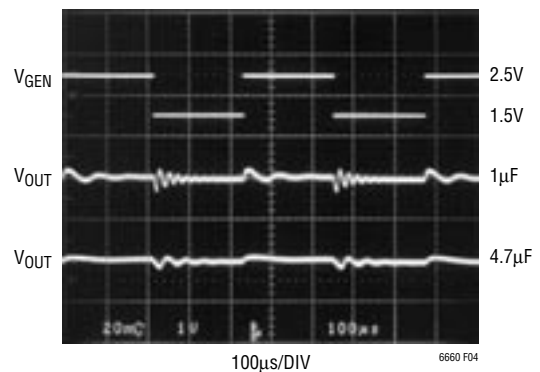

Figure 4. $I_{OUT} = 1mA$

APPLICATIONS INFORMATION

Table 1 gives the maximum output capacitance for various load currents and output voltages to avoid instability. Load capacitors with low ESR (effective series resistance) cause more ringing than capacitors with higher ESR such as polarized aluminum or tantalum capacitors.

Table 1. Maximum Output Capacitance

VOLTAGE OPTION	I _{OUT} = 100μA	I _{OUT} = 1mA	I _{OUT} = 10mA	I _{OUT} = 20mA
2.5V	>10μF	>10μF	2μF	0.68μF
3V	>10μF	>10μF	2μF	0.68μF
3.3V	>10μF	>10μF	1μF	0.68μF
5V	>10μF	>10μF	1μF	0.68μF
10V	>10μF	1μF	0.15μF	0.1μF

Long-Term Drift

Long-term drift cannot be extrapolated from accelerated high temperature testing. This erroneous technique gives drift numbers that are wildly optimistic. The only way long-term drift can be determined is to measure it over the time interval of interest. The LT6660 long-term drift data was taken on over 100 parts that were soldered into PC boards similar to a “real world” application. The boards were then placed into a constant temperature oven with T_A = 30°C, their outputs were scanned regularly and measured with an 8.5 digit DVM. Figure 5 shows typical long-term drift of the LT6660s.

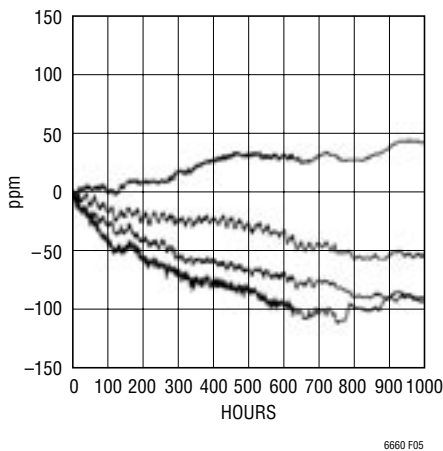

Figure 5. Typical Long-Term Drift

Hysteresis

Hysteresis data shown in Figure 6 and Figure 7 represents the worst-case data taken on parts from 0°C to 70°C and from -40°C to 85°C. The output is capable of dissipating relatively high power, i.e., for the LT6660-2.5, P_D = 17.5V • 20mA = 350mW. The thermal resistance of the DFN package is 102°C/W and this dissipation causes a 36°C internal rise. This elevated temperature may cause the output to shift due to thermal hysteresis. **For highest performance in precision applications, do not let the LT6660’s junction temperature exceed 85°C.**

Input Capacitance

It is recommended that a 0.1μF or larger capacitor be added to the input pin of the LT6660. This can help with stability when large load currents are demanded.

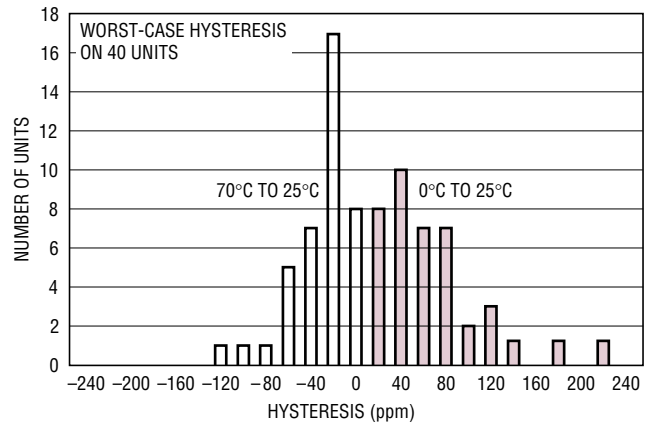

Figure 6. 0°C to 70°C Hysteresis

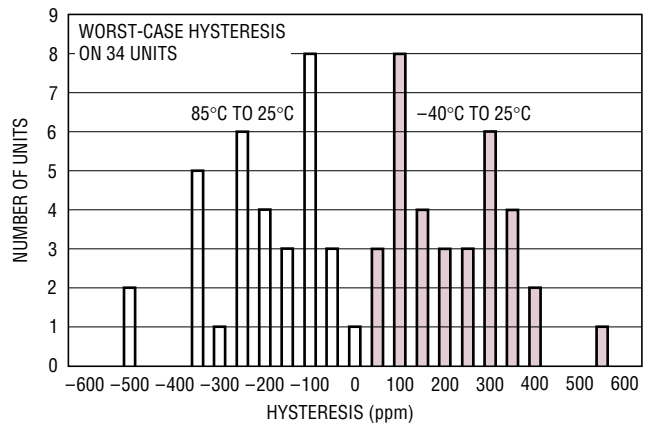

Figure 7. -40°C to 85°C Hysteresis

APPLICATIONS INFORMATION

Output Accuracy

Like all references, either series or shunt, the error budget of the LT6660s is made up of primarily three components: initial accuracy, temperature coefficient and load regulation. Line regulation is neglected because it typically contributes only 150ppm/V. The LT6660s typically shift 0.02% when soldered into a PCB, so this is also neglected. The output errors are calculated as follows for a 100μA load and 0°C to 70°C temperature range:

LT6660HCDC

Initial Accuracy = 0.2%

For $I_{OUT} = 100\mu A$

$$\Delta V_{OUT} = (4000\text{ppm/mA})(0.1\text{mA}) = 0.04\%$$

For Temperature 0°C to 70°C the maximum $\Delta T = 70^\circ C$

$$\Delta V_{OUT} = (20\text{ppm}/^\circ C)(70^\circ C) = 0.14\%$$

Total worst-case output error is:

$$0.2\% + 0.04\% + 0.14\% = 0.380\%$$

Table 2 gives the worst-case accuracy for LT6660HC, LT6660JC and LT6660KC from 0°C to 70°C, and shows that if the LT6660HC is used as a reference instead of a regulator, it is capable of 8 bits of absolute accuracy over temperature without a system calibration.

Table 2. Worst-Case Output Accuracy over Temperature

I_{OUT}	LT6660HCDC	LT6660JCDC	LT6660KCDC
0μA	0.340%	0.540%	0.850%
100μA	0.380%	0.580%	0.890%
10mA	0.640%	0.840%	1.15%
20mA	0.540%	0.740%	1.05%

PACKAGE DESCRIPTION

DC Package
3-Lead Plastic DFN (2mm × 2mm)
 (Reference LTC DWG # 05-08-1717 Rev 0)

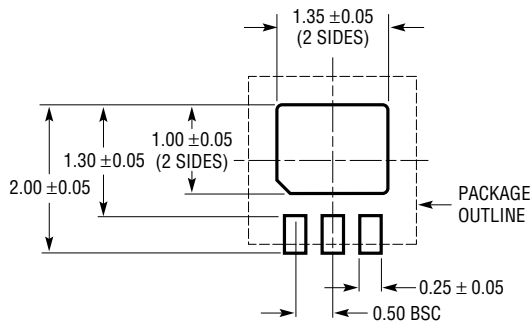

RECOMMENDED SOLDER PAD PITCH AND DIMENSIONS

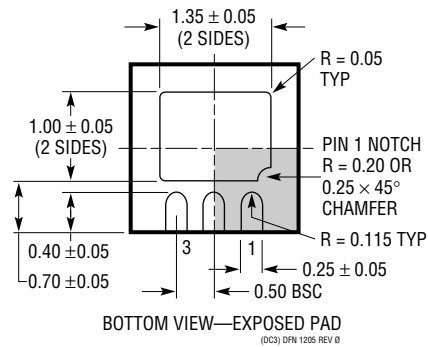
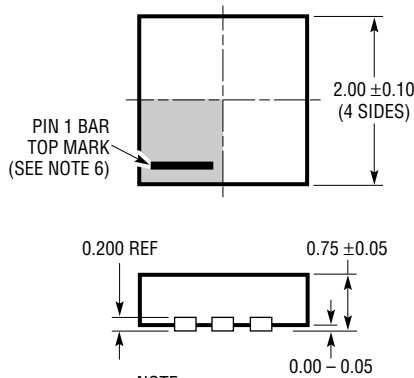

NOTE:

1. DRAWING TO BE MADE A JEDEC PACKAGE OUTLINE M0-229 VARIATION OF (W-TBD)
2. DRAWING NOT TO SCALE
3. ALL DIMENSIONS ARE IN MILLIMETERS
4. DIMENSIONS OF EXPOSED PAD ON BOTTOM OF PACKAGE DO NOT INCLUDE MOLD FLASH. MOLD FLASH, IF PRESENT, SHALL NOT EXCEED 0.15mm ON ANY SIDE
5. EXPOSED PAD SHALL BE SOLDER PLATED
6. SHADED AREA IS ONLY A REFERENCE FOR PIN 1 LOCATION ON THE TOP AND BOTTOM OF PACKAGE