

60V, 1.2A Synchronous Step-Down LED Driver

FEATURES

- Low Component Count and Simple Solution
- Wide Input Voltage Range: 6.5V to 60V
- 0V to 59V LED String Voltage
- ±3% LED Current Regulation
- Spread-Spectrum Frequency Modulation
- Internal Compensation Capacitor
- 20:1 Analog, Duty Cycle or PWM LED Current Control
- 330kHz/2MHz Fixed Internal Frequency (LT8374/LT8374-1)
- External Frequency Synchronization
- 4mm × 4mm 16-Pin Side Solderable QFN Package
- AEC-Q100 Qualified for Automotive Applications

APPLICATIONS

- Automotive Lighting
- Matrix LED Lighting
- General Purpose LED Driver
- Current Sources

DESCRIPTION

The **LT[®]8374/LT8374-1** is a high efficiency, monolithic, synchronous step-down DC/DC converter with fixed-frequency and peak current control. The LED current is programmed by a resistor from the CTRL pin to ground or by applying a PWM signal to the CTRL pin. The current sense amplifier has a wide common mode range from 0V to V_{IN} , making the LT8374 ideal for matrix applications. An output voltage limit can be set with a resistor from ISP pin to FB pin.

The switching frequency is set at 330kHz/2MHz and can be synchronized to an external clock applied to the SYNC/SPRD pin. With the optional spread-spectrum frequency modulation enabled, the frequency varies from 100% to 125% to reduce EMI.

Additional features include an optional 0.2nF/0.9nF internal compensation capacitor and thermal shutdown.

All registered trademarks and trademarks are the property of their respective owners.

TYPICAL APPLICATION

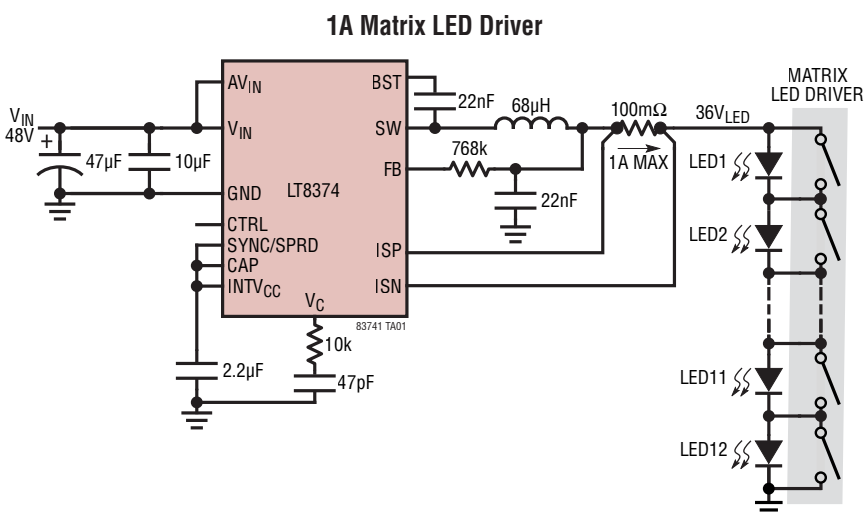

LT8374 plus LT3967 Matrix Sequential Turn On/Off, 12 LEDs

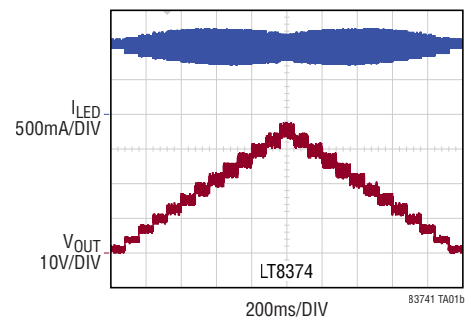

LT8374

ABSOLUTE MAXIMUM RATINGS

(Note 1)

AV_{IN} , V_{IN} , ISP , ISN	60V
$ISP - ISN$	$\pm 0.3V$
SW , BST , $INTV_{CC}$	(Note 2)
$SYNC/SPRD$	5.5V
$CTRL$, FB , V_C , CAP	3.3V
Operating Junction Temperature (Note 3)	
LT8374R/LT8374R-1	$-40^{\circ}C$ to $150^{\circ}C$
Storage Temperature Range	$-60^{\circ}C$ to $150^{\circ}C$

PIN CONFIGURATION

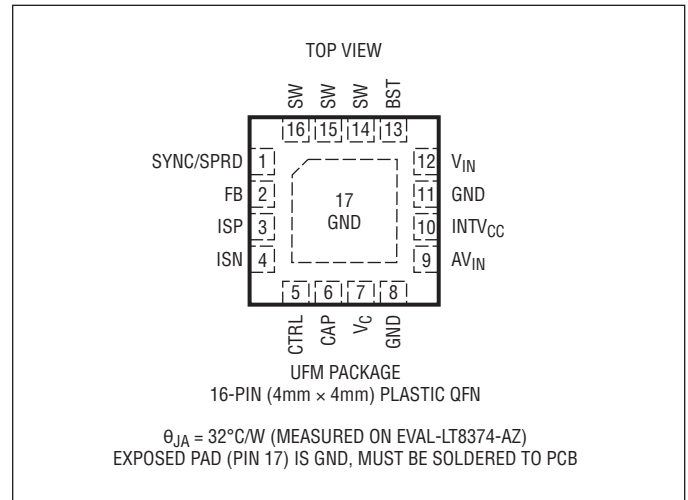

ORDER INFORMATION

LEAD FREE FINISH	TAPE AND REEL	PART MARKING	PACKAGE DESCRIPTION	TEMPERATURE RANGE
AUTOMOTIVE PRODUCTS*				
LT8374RUFM#WPBF	LT8374RUFM#WTRPBF	8374	16-Pin (4mm × 4mm) Plastic Side Solderable QFN	$-40^{\circ}C$ to $150^{\circ}C$
LT8374RUFM-1#WPBF	LT8374RUFM-1#WTRPBF	83741	16-Pin (4mm × 4mm) Plastic Side Solderable QFN	$-40^{\circ}C$ to $150^{\circ}C$

- Device temperature grade is indicated by a label on the shipping container.
- Pad or ball finish code is per IPC/JEDEC J-STD-609.
- Parts ending with PBF are RoHS and WEEE compliant.

*Versions of this part are available with controlled manufacturing to support the quality and reliability requirements of automotive applications. These models are designated with a #W suffix. Only the automotive grade products shown are available for use in automotive applications. Contact your local Analog Devices account representative for specific product ordering information and to obtain the specific Automotive Reliability reports for these models.

ELECTRICAL CHARACTERISTICS The ● denotes the specifications which apply over the full operating temperature range, otherwise specifications are at $T_A = 25^\circ\text{C}$. $V_{IN} = 12\text{V}$ unless otherwise noted.

PARAMETER	CONDITIONS		MIN	TYP	MAX	UNITS
AV_{IN} Operating Voltage Range			6.5		60	V
AV_{IN} Quiescent Current	$AV_{IN} = 4\text{V}$, Not Switching			2.3		mA
AV_{IN} UVLO Threshold Voltage Falling					5.5	V
AV_{IN} UVLO Threshold Rising Hysteresis				700		mV
LED Current Regulation						
CTRL OFF Threshold (Falling)		●	200	225	250	mV
CTRL OFF Rising Hysteresis				15		mV
CTRL Pin Current	$V_{CTRL} = 1\text{V}$	●	19.4	20	20.6	μA
Sense Voltage ($V_{ISP} - V_{ISN}$), Analog Input	$V_{CTRL} = 2\text{V}$ (100%), $V_{IN} = 36\text{V}$, $V_{ISP} = 24\text{V}$ $V_{CTRL} = 0.75\text{V}$ (50%), $V_{IN} = 36\text{V}$, $V_{ISP} = 24\text{V}$ $V_{CTRL} = 0.3\text{V}$ (5%), $V_{IN} = 36\text{V}$, $V_{ISP} = 24\text{V}$	●	97	100	103	mV
		●	48	50	52	mV
		●	3	5	7	mV
ISP Current	$V_{ISP} = 12\text{V}$, $V_{ISN} = 12\text{V}$, $V_{CTRL} = 2\text{V}$ $V_{ISP} = 0\text{V}$, $V_{ISN} = 0\text{V}$, $V_{CTRL} = 2\text{V}$			30		μA
				340		μA
ISN Current	$V_{ISP} = 12\text{V}$, $V_{ISN} = 12\text{V}$, $V_{CTRL} = 2\text{V}$ $V_{ISP} = 0\text{V}$, $V_{ISN} = 0\text{V}$, $V_{CTRL} = 2\text{V}$			30		μA
				340		μA
Error Amplifier Transconductance	$V_{ISP} = 12\text{V}$ $V_{ISP} = 0\text{V}$			33		$\mu\text{A}/\text{V}$
				33		$\mu\text{A}/\text{V}$
Duty-Cycle Control of LED Current						
Sense Voltage ($V_{ISP} - V_{ISN}$), Duty-Cycle Input	CTRL Duty = 75%, $V_{IN} = 36\text{V}$, $V_{ISP} = 24\text{V}$ CTRL Duty = 37.5%, $V_{IN} = 36\text{V}$, $V_{ISP} = 24\text{V}$ CTRL Duty = 15%, $V_{IN} = 36\text{V}$, $V_{ISP} = 24\text{V}$		97	100	102	mV
			47	50	52	mV
			3	5	7	mV
CTRL Pulse Input High (V_{IH})			1.6			V
CTRL Pulse Input Low (V_{IL})					400	mV
CTRL Pulse Input Frequency Range			15		200	kHz
Voltage Regulation						
FB Regulation Voltage	$V_{ISP} = V_{ISN} = 6\text{V}$, $V_{CTRL} = 2\text{V}$	●	1.013	1.040	1.068	V
FB Internal Resistor to Ground		●	15	16.5	18.5	$\text{k}\Omega$
Voltage Error Amplifier Transconductance				535		$\mu\text{A}/\text{V}$
Oscillator						
Switching Frequency	LT8374 LT8374-1	●	310	330	350	kHz
		●	1900	2000	2100	kHz
Spread-Spectrum Frequency Range	SYNC/SPRD Pin Open LT8374 LT8374-1		310		440	kHz
			1900		2650	kHz
SYNC/SPRD Threshold (Rising)				1.4		V
SYNC/SPRD Fall Hysteresis				220		mV
SYNC/SPRD Pull-Up Resistor (Internal)	From SYNC/SPRD to Internal INTV_{CC}			470		$\text{k}\Omega$
Power Switch						
Top Switch On-Resistance				350		$\text{m}\Omega$
Bottom Switch On-Resistance				375		$\text{m}\Omega$
Peak Current Limit			1.65	2	2.35	A
Minimum Off-Time	(Note 5)			46		ns
Minimum On-Time	(Note 5)			78		ns

ELECTRICAL CHARACTERISTICS

The ● denotes the specifications which apply over the full operating temperature range, otherwise specifications are at $T_A = 25^\circ\text{C}$. $V_{IN} = 12\text{V}$ unless otherwise noted.

PARAMETER	CONDITIONS	MIN	TYP	MAX	UNITS
Internal Compensation Capacitor					
Capacitor Value	CAP Float, $V_C = 1.2\text{V}$ CAP = 0V, $V_C = 1.2\text{V}$		0.9 0.2		nF nF
Equivalent Series Resistance	CAP Float, $V_C = 1.2\text{V}$ CAP = 0V, $V_C = 1.2\text{V}$		27 19		k Ω k Ω
Capacitor Leakage	CAP Float, $V_C = 1.2\text{V}$ CAP = 0V, $V_C = 1.2\text{V}$	-70 -5		70 5	nA nA
Overvoltage Protection					
FB Overvoltage Threshold (Rising)			1.1		V
FB Overvoltage Falling Hysteresis			48		mV

Note 1: Stresses beyond those listed under Absolute Maximum Ratings may cause permanent damage to the device. Exposure to any Absolute Maximum Rating condition for extended periods may affect device reliability and lifetime.

Note 2: Do not apply a positive or negative voltage source to these pins, otherwise permanent damage may occur.

Note 3: The LT8374R is specified over the -40°C to 150°C operating junction temperature range. High junction temperatures degrade operating lifetimes. Note the maximum ambient temperature consistent with these specifications is determined by specific operating conditions in conjunction with board layout, the rated package thermal impedance and other environmental factors.

Note 4: This IC includes overtemperature protection that is intended to protect the device during momentary overload conditions. The maximum rated junction temperature will be exceeded when this protection is active. Continuous operation above the specified absolute maximum operating junction temperature may impair device reliability or permanently damage the device.

Note 5: The minimum on and off times are guaranteed by design and are not tested

TYPICAL PERFORMANCE CHARACTERISTICS $T_A = 25^\circ\text{C}$, $V_{IN} = 12\text{V}$ unless otherwise noted.

LED Current (5% Regulation)

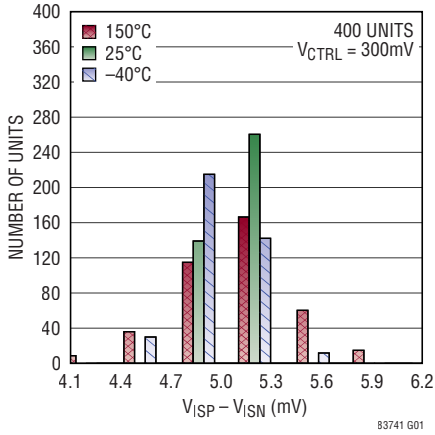

LED Current (100% Regulation)

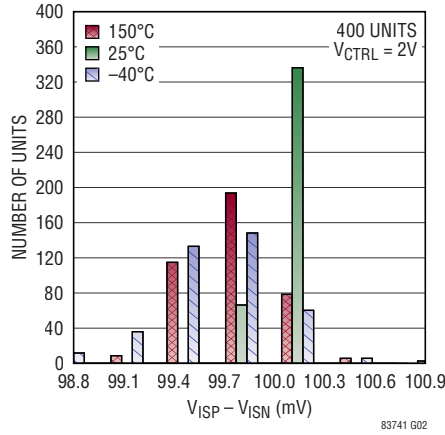

Efficiency vs I_{LED}

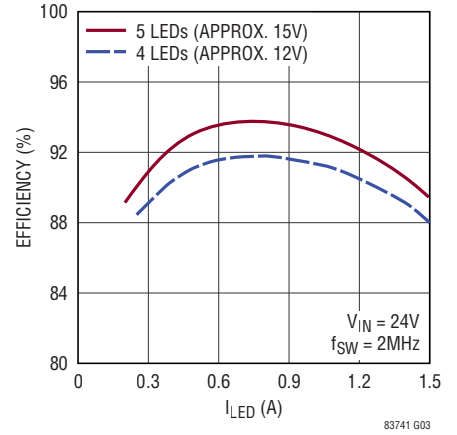

Efficiency vs V_{IN}

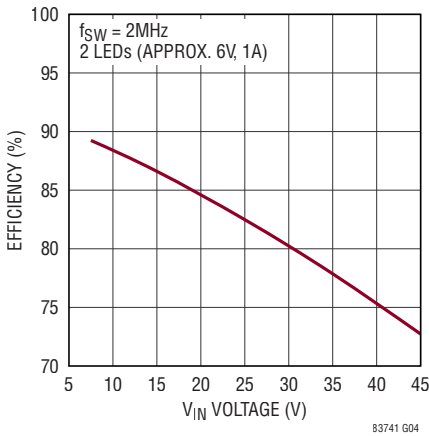

LED Current vs V_{OUT}

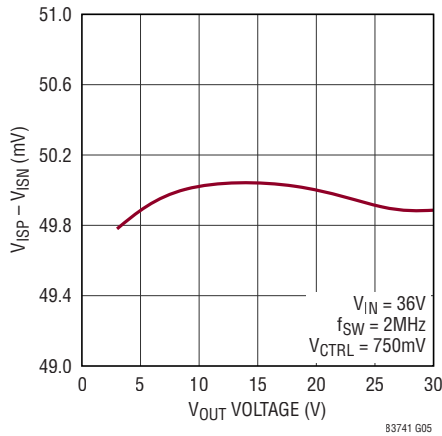

LED Current Line Regulation

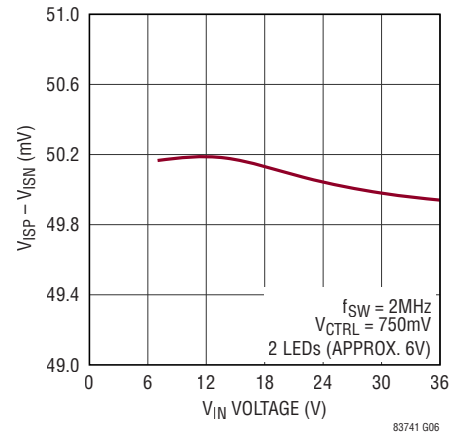

LED Current (Analog CTRL)

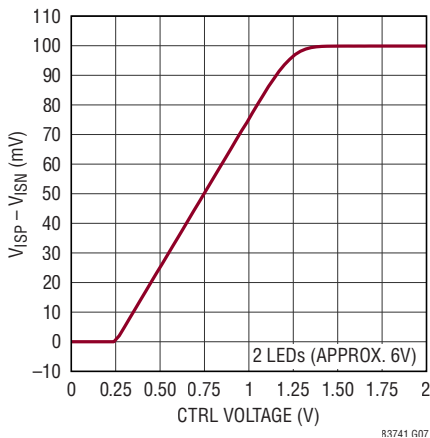

LED Current (Digital CTRL)

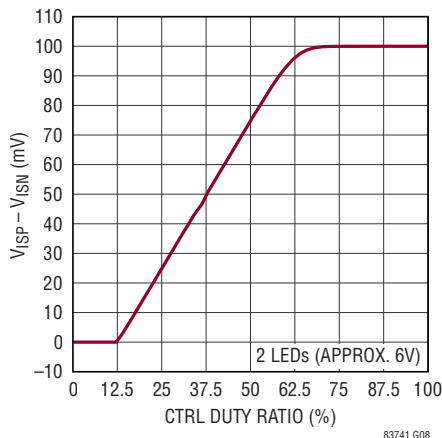

LED Voltage Limit

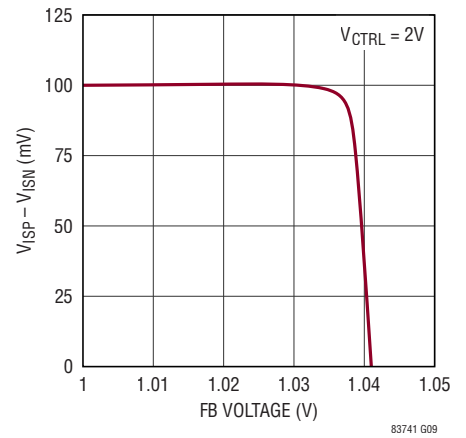

TYPICAL PERFORMANCE CHARACTERISTICS $T_A = 25^\circ\text{C}$, $V_{IN} = 12\text{V}$ unless otherwise noted.

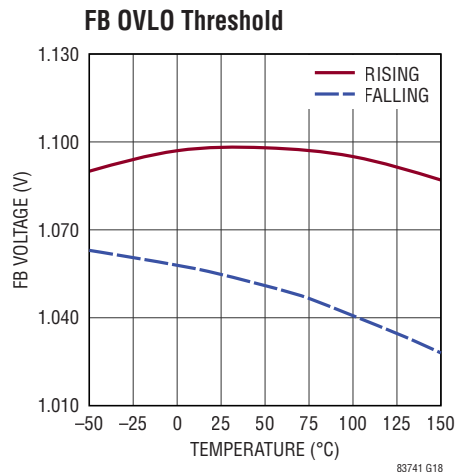
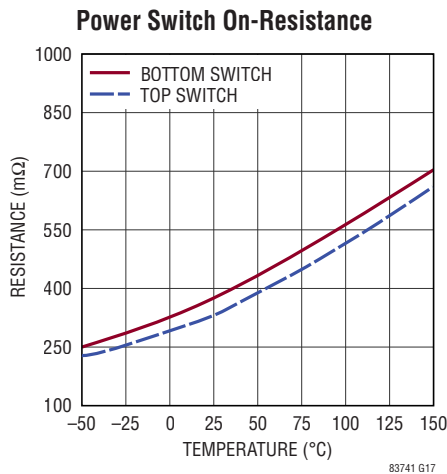
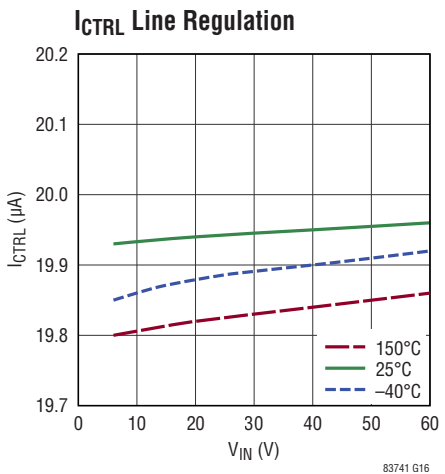
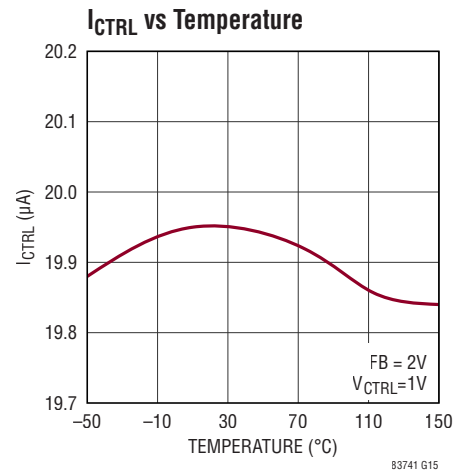
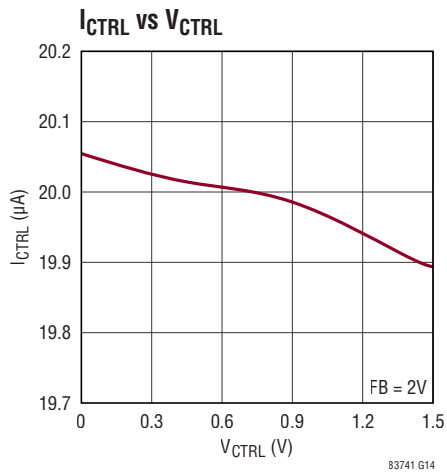
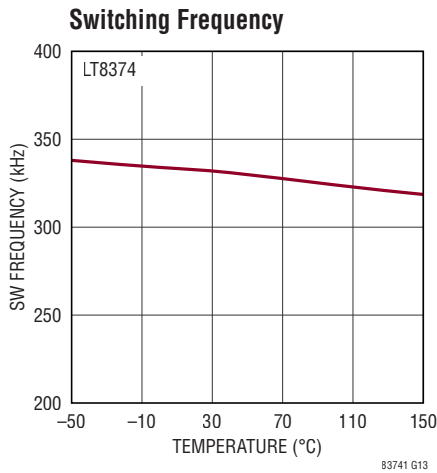
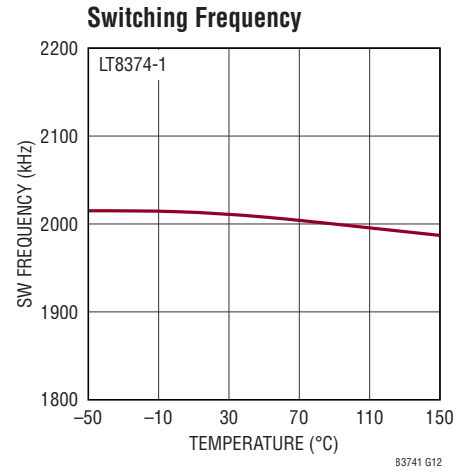
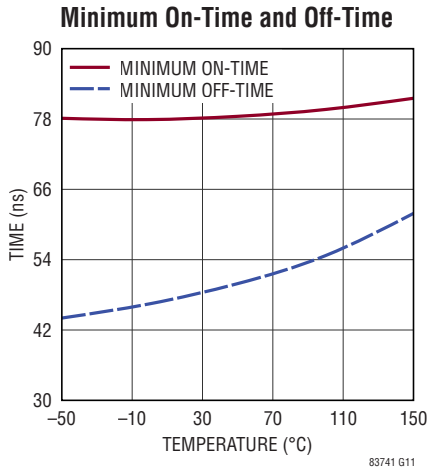
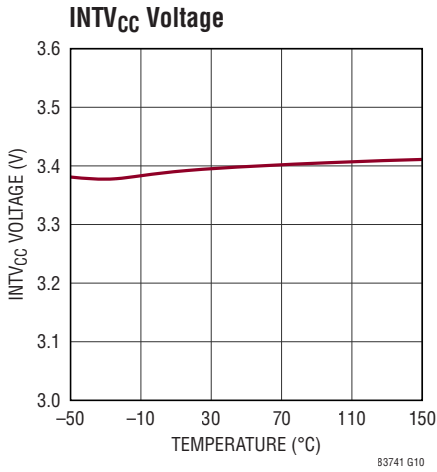

TYPICAL PERFORMANCE CHARACTERISTICS $T_A = 25^\circ\text{C}$, $V_{IN} = 12\text{V}$ unless otherwise noted.

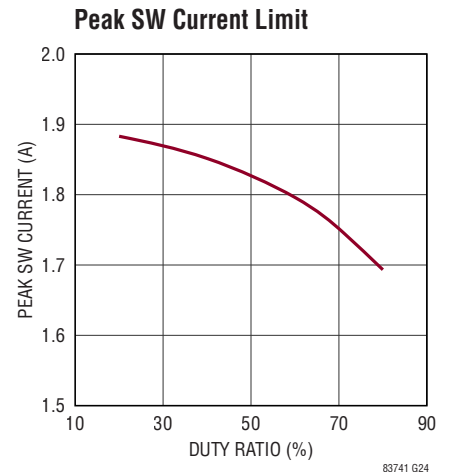
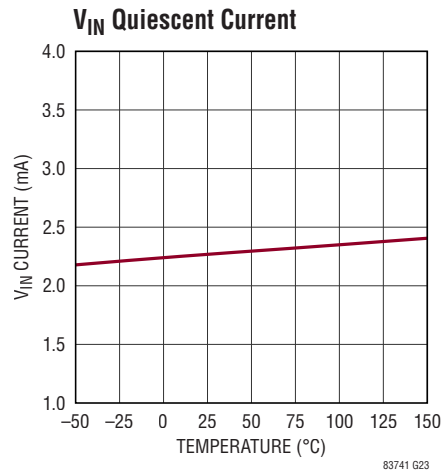
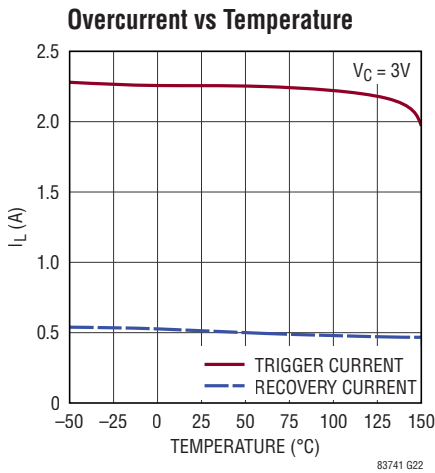
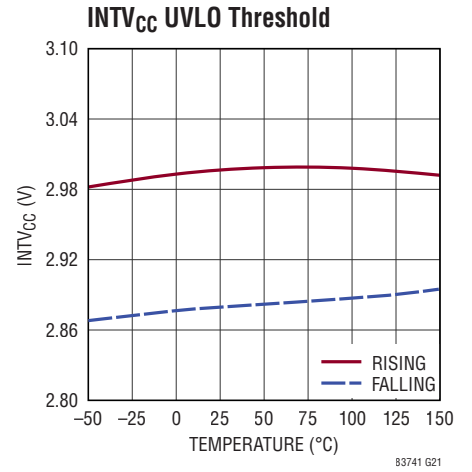
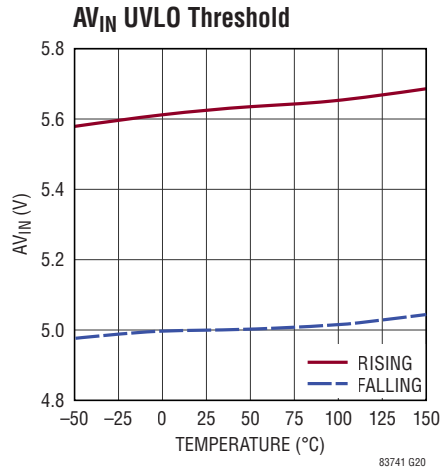
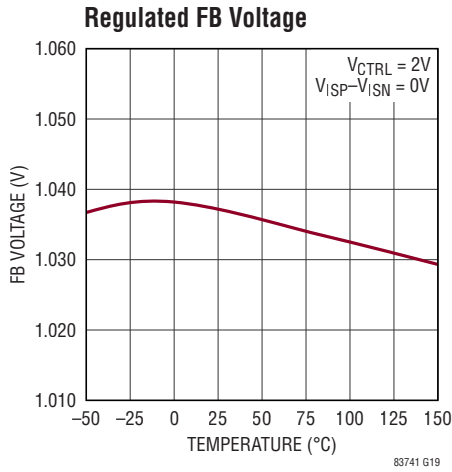

PIN FUNCTIONS

SYNC/SPRD (Pin 1): Synchronization Pin. To synchronize the programmed switching frequency, drive this pin with an external clock having a frequency of 330kHz for the LT8374 and 2MHz for the LT8374-1. Leave this pin open or tie the pin to $INTV_{CC}$ to enable spread-spectrum frequency modulation. This pin should be tied to GND when not in use.

FB (Pin 2): Feedback Pin. When the voltage at this pin is near 1.04V, the regulated current is automatically reduced from the programmed value. A resistor between this pin and ISP together with an internal 16.5k resistor can be used to set a limit for the output voltage. If the voltage at the FB pin reaches 1.1V, an overvoltage lockout comparator disables switching.

ISP (Pin 3): Positive Current Sense Pin. This pin is one of the inputs to the internal current sense error amplifier. It should be connected to the positive side of the external sense resistor.

ISN (Pin 4): Negative Current Sense Pin. This pin is one of the inputs to the internal current sense error amplifier. It should be connected to the negative side of the external sense resistor.

CTRL (Pin 5): Control Pin. An analog voltage from 250mV to 1.25V at this pin programs the regulated voltage between ISP and ISN (and therefore, the regulated current supplied to the load). An accurate 20 μ A current source is provided at this pin which could be used to set the control voltage with a resistor. Alternatively, a digital pulse at this pin with duty cycle from 12.5% to 62.5% can be used to program the regulated voltage. Below 200mV or 10% duty cycle, the CTRL pin voltage disables switching. CTRL pin can also be used to input a 100Hz to 200Hz PWM dimming signal, which can linearly increase the LED current with very fine resolution. This part can support PWM duty cycle from 1% to 90% at 100Hz. If dimming function is not needed, leave this pin floating or tie to $INTV_{CC}$. For more detail, see Regulated LED Current in Typical Performance Characteristics section and Programming LED Current with the CTRL Pin in Applications Information.

CAP (Pin 6): Compensation Capacitor Selection Pin. When this pin is connected to GND, an internal 200pF capacitor

in series with a 19k resistor will be connected to V_C pin. When this pin is floating, an internal 0.9nF capacitor in series with a 27k resistor will be connected to V_C pin. When this pin is connected to $INTV_{CC}$, external components should be connected to V_C pin for compensation.

V_C (Pin 7): Compensation Pin. A capacitor connected from this pin to GND stabilizes the current and voltage regulation. Float this pin when using internal compensation. See Stabilizing the Regulation Loop in the Applications Information section for more details.

GND (Pins 8, 11, 17): Ground Pins. These pins must be soldered to the ground plane of the circuit board.

AV_{IN} (Pin 9): Analog Input Voltage Pin. This pin supplies power to the internal high performance circuitry. AV_{IN} and V_{IN} are normally tied together, but not required. In some high voltage and high power applications, AV_{IN} can be tied to 12V battery to reduce the power loss and thus improve thermal performance. Connect capacitors between this pin and GND and see Selecting and Placing the Input Capacitors in Applications Information for advice regarding their placement.

$INTV_{CC}$ (Pin 10): Internally Regulated, Low Voltage Supply Pin. This pin provides the power for the converter switch gate drivers. Do not force any voltage on this pin, but bypass it with a 2.2 μ F capacitor to GND.

V_{IN} (Pin 12): Input Voltage Pin. This pin supplies power to the inductor current when the internal high side power switch is on. Connect capacitors between this pin and GND. See Selecting and Placing the Input Capacitors in Applications Information for advice regarding their placement.

BST (Pin 13): Boost Pin. This pin supplies the high side power switch driver. Connect a 22nF capacitor between this pin and SW. An internal diode from $INTV_{CC}$ to BST will charge the capacitor when the SW pin is low.

SW (Pins 14, 15, 16): Switch Pins. These pins are internally connected to the power devices and drivers. They should always be tied together. In normal operation, the voltage of these pins will switch between the input voltage and zero at the programmed frequency. Do not force any voltage on these pins.

OPERATION

The LT8374/LT8374-1 are step-down LED drivers that utilize a fixed frequency, peak-current control to accurately regulate the current through a string of LEDs. They include two power switches, their drivers, and a diode for providing power to the top switch driver. The switches connect an external inductor at the SW pin alternately to the input supply and then to ground. The inductor current rises and falls accordingly and the peak current can be regulated by adjusting the duty ratio of the power switches through the combined effect of the other circuit blocks.

The synchronous controller ensures the power switches do not conduct at the same time, and the oscillator turns on the top switch at the beginning of each switching cycle. The frequency of this oscillator is set internally to 330kHz (LT8374) or 2MHz (LT8374-1) and can be synchronized by external pulses at the SYNC/SPRD pin. The SYNC/SPRD pin can also be used to command spread-spectrum frequency modulation (SSFM), which reduces radiated and conducted electromagnetic interference (EMI).

The top switch is turned off by the peak current comparator which waits during the on-time for the increasing inductor current to exceed the target set by the voltage at V_C pin. This target is modified by a signal from the oscillator which stabilizes the inductor current. The V_C pin needs to be connected to either an external capacitor (or resistor and capacitor) or floated to use internal compensation.

The target for the inductor current is derived from the desired LED current programmed by the voltage at the CTRL pin. The CTRL pin has an accurate 20 μ A current source that can be used with an external resistor, or potentiometer to set the analog voltage at the CTRL pin. The analog-to-digital detector and the control buffer convert either a DC voltage or digital pulses at the CTRL pin into threshold for the current regulation amplifier. The inputs to this amplifier are the ISP and ISN pin voltages. An external current sense resistor between these pins should be placed in series with the string of LEDs such that the voltage across it provides the feedback to regulate the LED current. The current regulation amplifier then compares the actual LED current to the programmed LED current and adjusts V_C as necessary.

During start-up, the regulator will first charge the CTRL pin with a small current of 20 μ A. When CTRL pin voltage reaches 250mV, the regulation loop will start to output current to the load that follows the level programmed by CTRL pin voltage. A capacitor can be placed on the CTRL pin to control the start-time for the regulator if there is special requirement.

The current regulation amplifier can be overridden by the voltage regulation amplifier, which compares the FB pin voltage to an internal 1.04V reference. An external resistor from ISP Pin to the FB pin provides an indication of the LED string voltage and allows the voltage amplifier to prevent overvoltage of the LED string.

APPLICATIONS INFORMATION

The following is a guide to selecting the external components and configuring the LT8374/LT8374-1 according to the requirements of an application.

Programming LED Current with the CTRL Pin

The primary function of the LT8374/LT8374-1 is to regulate the current for a string of LEDs. This current passes through a series current sense resistor that can be placed anywhere in the string. The voltage across this resistor is sensed by the current regulation amplifier through the ISP and ISN pins and regulated to a level programmed by the CTRL pin. The maximum resistor voltage that can be programmed is 100mV, which corresponds to 1A through the LED string when a 100mΩ current sense resistor is used.

To allow for this maximum current, the CTRL pin may be connected directly to the INTV_{CC} pin, which provides a voltage higher than 1.25V. Lower current levels can be programmed by DC CTRL voltages between 250mV and 1.25V as shown in Figure 1.

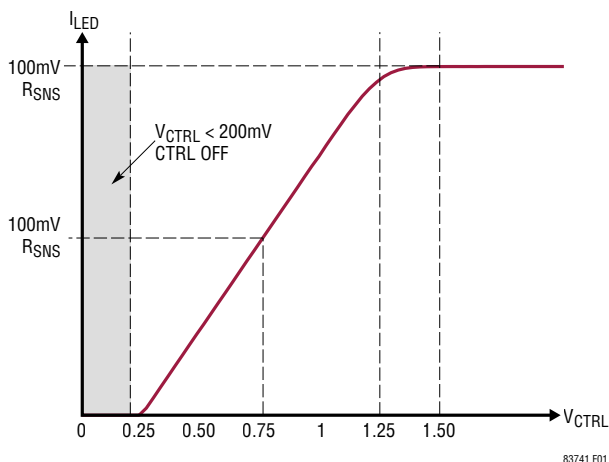

Figure 1. Analog CTRL Range

Below 250mV, the CTRL pin commands zero LED current, and above 1.25V, it commands the maximum. There is a 20μA accurate current source on the CTRL pin, which can be used to set the control voltage with a resistor from the CTRL pin to GND. As an example, a 37.4k resistor to GND will produce 748mV on the CTRL pin, corresponding to 49.8mV regulated voltage between ISP and ISN.

Additionally, the LT8374/LT8374-1 is capable of interpreting a pulse at the CTRL pin. The high level of the pulse

must be greater than 1.6V. The low level must be less than 400mV. The frequency must be greater than 10kHz and less than 200kHz. The regulated voltage between ISP and ISN will vary with the duty ratio of the pulse as shown in Figure 2.

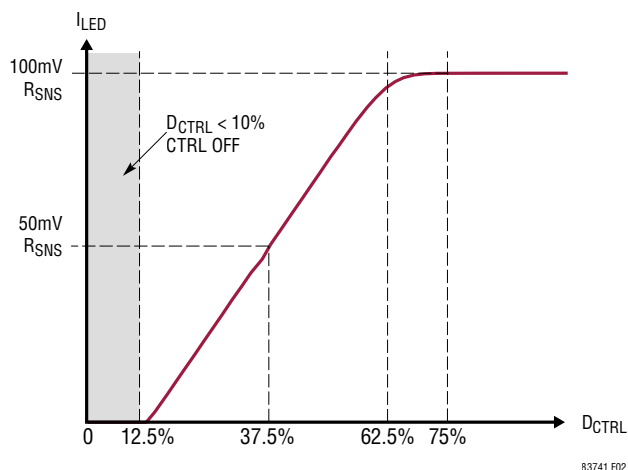

Figure 2. Duty Ratio CTRL Range

In this case, the LED current is zero for duty ratios less than 12.5% and reaches its maximum above 62.5%. Switching will cease if the duty ratio of the CTRL pin pulse is less than 10%, and also for DC CTRL pin voltages less than 200mV.

PWM Dimming

Pulse width modulation (PWM) dimming of the LED current is an effective way to control the brightness of the light without varying its color. The brightness can also be adjusted more accurately this way than by varying the current level.

PWM dimming of LT8374/LT8374-1 can be done by toggling CTRL pin with a digital pulse of 100Hz at CTRL pin with maximum duty cycle of 90%. When the CTRL is low, the error amplifier will be disconnected from the compensation capacitor to preserve charge on the compensation capacitor for fast recovery in the next cycle. An external compensation capacitor with low leakage or the internal 200pF compensation capacitor is preferred for lower than 1% duty cycle PWM dimming. The internal 0.9nF compensation capacitor should be used when the PWM duty cycle is above 2% at 100Hz dimming frequency.

APPLICATIONS INFORMATION

Enabling Spread-Spectrum Frequency Modulation

Connecting SYNC/SPRD to INTV_{CC} or leaving it unconnected will enable spread-spectrum frequency modulation (SSFM). The switching frequency will vary from its preset frequency to 125% of that frequency. If neither synchronization nor SSFM is required, connect SYNC/SPRD to GND.

As shown in Figure 3, enabling SSFM can significantly attenuate the electromagnetic interference that the LT8374/LT8374-1 emits at the switching frequency and its harmonics. This feature is designed to help devices that include the LT8374/LT8374-1 perform better in the various standard industrial tests related to interference.

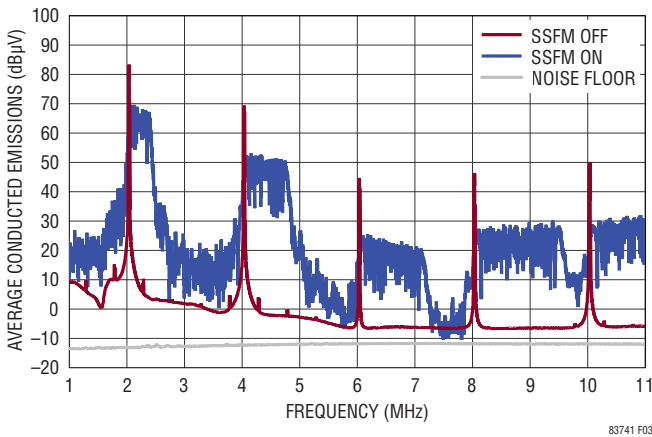

Figure 3. Typical Average Conducted Emissions with SSFM ON/OFF for the LT8374-1

The attenuation varies depending on the range of frequencies in which interference is measured, and whether a test measures peak, quasi-peak, or average emissions. The results of several other such emission measurements are with select Typical Applications.

Synchronizing Switching Frequency

The switching frequency can also be synchronized to an external clock connected to the SYNC/SPRD pin. The high level of the external clock must be at least 1.4V, and the frequency must be 330kHz/2MHz (LT8374/LT8374-1). If the external clock ever stops, the LT8374/LT8374-1 will switch at its own 300kHz/2MHz generated from internal oscillator.

Understanding the Short Circuit Current Limit

Operation at low output voltages should be made knowing that, although the maximum LED current can be programmed with the CTRL pin, the inductor current may exceed this current value when the output voltage is low during a short-circuit. This is because there is a minimum on-time for which the SW pin will be driven high during each switching period. The inductor current increases during this time, since the frequency is high and the output voltage low, there may not be enough off-time remaining in each switching period for the inductor current to decrease back to the level at which it started. In this case, the net inductor current would increase with each switching period regardless of the state of the CTRL pin.

To prevent large inductor currents that would damage the LT8374/LT8374-1, the high-side switch is not turned on until the inductor current decreases to less than 0.5A, which is called the “recovery current”, after it hits the short circuit current limit. The maximum inductor current may increase by 30% of the peak current, but the off-time and the switching period are extended until the inductor current reaches equilibrium as shown in Figure 4.

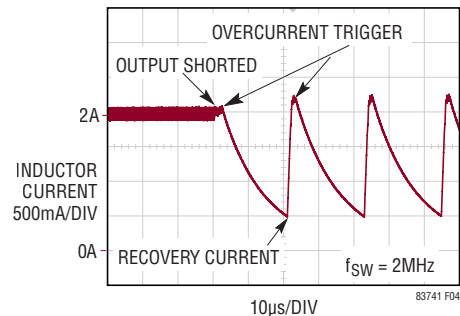

Figure 4. Overcurrent Behavior

Selecting an Inductor

The inductor must be rated for the current limit regardless of the intended application. Its value, in most applications, should be selected such that the inductor current ripple is no more than 25% of the maximum output current. When that current is 1A, for example, the minimum inductance can be calculated using Equation 1.

$$L = 4\mu\text{H} \cdot \frac{V_{\text{OUT}}}{V_{\text{IN}(\text{MAX})}} \cdot \frac{V_{\text{IN}(\text{MAX})} - V_{\text{OUT}}}{1\text{V}} \cdot \frac{1\text{MHz}}{f_{\text{SW}}} \quad (1)$$

APPLICATIONS INFORMATION

However, for high output voltages even Equation 1 would suggest an inductance value that is too small. For stability, the LT8374/LT8374-1 requires an inductance greater than the value given by Equation 2.

$$L = 2\mu\text{H} \cdot \frac{V_{\text{OUT}}}{1\text{V}} \cdot \frac{1\text{MHz}}{f_{\text{SW}}} \quad (2)$$

Choose the larger of the values given by Equation 1 and Equation 2. The manufacturers featured in Table 1 are recommended sources of inductors.

Table 1. Inductor Manufacturers

MANUFACTURER	WEBSITE
Würth Elektronik	www.we-online.com
Coilcraft	www.coilcraft.com

Selecting an Output Capacitor

Some applications are sensitive to ripple current in the LED string. In those cases, a capacitor at the output will absorb part of the inductor current ripple and thereby reduce the LED current ripple. Typically, the suggested value of this capacitance is inversely proportional to the switching frequency and the output voltage given by Equation 3.

$$C_{\text{OUT}} = 100\mu\text{F} \cdot \frac{1\text{V}}{V_{\text{OUT}}} \cdot \frac{1\text{MHz}}{f_{\text{SW}}} \quad (3)$$

Use X7R or X5R ceramic capacitors as they retain their capacitance better than other capacitor types over a wide voltage and temperature range. Sources of quality ceramic and electrolytic capacitors are listed in Table 2.

Table 2. Capacitor Manufacturers

MANUFACTURER	WEBSITE
Murata Manufacturing	www.murata.com
Garrett Electronics	www.garrettelec.com
AVX	www.avx.com
Nippon Chemi-Con	www.chemi-con.co.jp/e

Stabilizing the Regulation Loop

Stabilizing the regulation loop requires a capacitor (or resistor in series with a capacitor) connected from the V_C pin to GND. An internal compensation network on the V_C pin has a capacitor and a resistor in series that could be used in most design scenarios. When the output capacitor is very large, the output pole is shifted to low frequencies, these designs need to use a larger external compensation capacitor. See Typical Applications for some examples.

Selecting and Placing the Input Capacitors

Although they do not impact stability, several capacitors are necessary between V_{IN} and GND to properly bypass the input supply voltage. At least $10\mu\text{F}$ is required in total, although it does not have to be composed entirely of ceramic capacitors placed very close to the V_{IN} pin. However, it is important that a ceramic capacitor be placed as close as possible between V_{IN} pin (Pin 12) and its adjacent GND pin (Pin 11) as shown in Figure 5 for providing current for the power switches. This capacitor should be at least $0.47\mu\text{F}$ if possible.

It is suggested that another $0.47\mu\text{F}$ capacitor should be placed very close to AV_{IN} pin (Pin 9), which supplies the internal control circuitry, for reducing the power ripple for the internal control circuitry.

Selecting the FB Resistors

A resistor should be selected to form a network between the output voltage and an internal 16.5k resistor on the FB pin.

This network forms part of a voltage regulation loop when FB is close to 1.04V . In this case, the programmed LED current will be overridden to limit V_{FB} to 1.04V . This resistor configuration therefore determines the maximum output voltage.

Note that this voltage limit may be reached inadvertently if it is set too close to the typical output voltage and the output capacitor is too small. To avoid interference with the current regulation, the feedback resistor should be chosen such that FB is about 700mV typical during current regulation.

APPLICATIONS INFORMATION

As an example, for a 12V string of LEDs, design for a maximum output voltage of about 17V. To approximately calculate the value of the feedback resistor, add 16.5k for every volt of difference between FB (1.04V) and the maximum output voltage. In this case, the nearest standard 1% value for the feedback resistor would be 255k.

Understanding FB Overvoltage Lockout

It is possible that the FB voltage can exceed the 1.04V limit. If the output voltage is near the maximum when the LED string opens, it may take too long for the feedback loop to adjust the inductor current and avoid overcharging the output. However, if the FB voltage exceeds the 1.1V overvoltage lockout threshold, the LT8374/LT8374-1 will immediately stop switching and resume only when FB decreases to 1.04V.

This threshold may be routinely exceeded when operated as a voltage regulator and the load current decreases rapidly. In this case, the pause in switching limits the output overshoot and ensures that the voltage is back in regulation as quickly as possible. For safe operation, choose FB resistor values to ensure the output voltage is not greater than V_{IN} when the FB voltage is 1.1V.

Planning for Thermal Shutdown

The LT8374/LT8374-1 automatically stops switching when the internal temperature is too high. The temperature limit is guaranteed to be higher than the operational temperature of the part. During thermal shutdown, all switching is terminated.

The exposed pad on the bottom of the package must be soldered to a ground plane. Vias placed directly under the package are necessary to dissipate heat. Following these guidelines, the four-layer demo board EVAL-LT8374-1-AZ reduces the thermal resistance, θ_{JA} to 32°C/W. With compromised board design, θ_{JA} could be 40°C/W or higher.

Designing the Printed Circuit Board

Note that large switched currents flow through the local input capacitors and the V_{IN} (Pin 12) and GND pin (Pin 11). The loops traveled by these currents should be made as small as possible by keeping the capacitors as close as possible to these pins and connected on the same layer.

Other large, bulk input capacitors can be safely placed farther from the chip and on the other side of the board.

Create a Kelvin ground network by keeping the ground connection for all of the other components separate. It should only join the ground for the input and output capacitors and the return path for the LED current at the exposed pad. Please refer to Figure 5 for more design information.

There are a few other aspects of the board design that improve performance. An unbroken ground plane on the second layer dissipates heat, but also reduces noise. Likewise minimizing the area of the SW and BST nodes reduces noise. The traces for FB and V_C should be kept short to lessen the susceptibility to noise of these high impedance nodes. Matched Kelvin connections from the external current sense resistor R_S to the ISP and ISN pins are essential for current regulation accuracy. The 2.2 μ F INTV_{CC} capacitors as well as the 22nF BST capacitor should be placed as closely as possible to their respective pins. A capacitor from the CTRL pin to GND can compensate for compromised layouts. Please refer to the demo board layout EVAL-LT8374-1-AZ for an example of how to implement these recommendations.

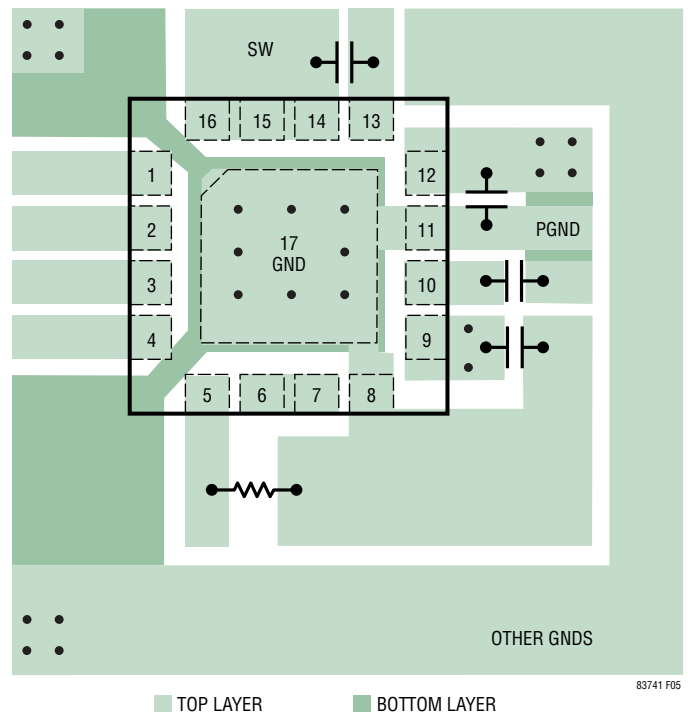
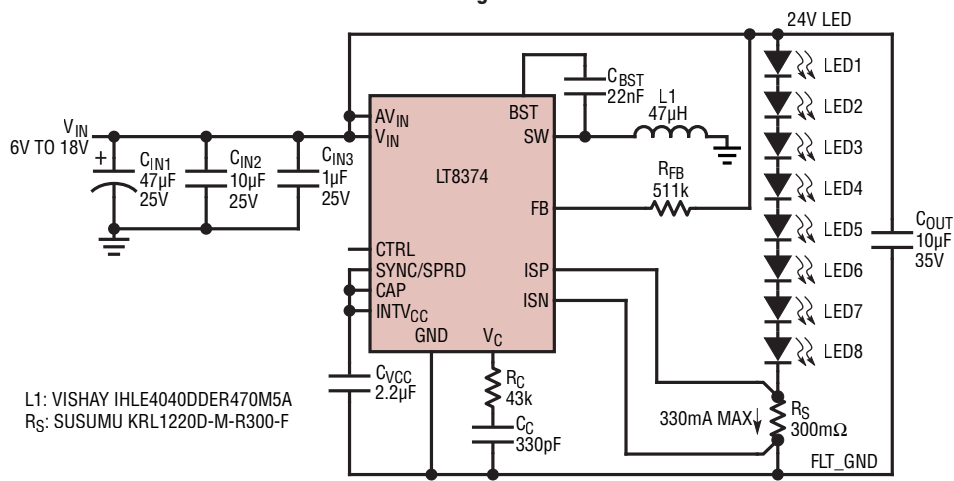

Figure 5. PCB GND Planing and Components Placement

TYPICAL APPLICATIONS

LT8374: 330mA Inverting Boost Mode LED Driver



83741 TA02a

LT8374: Boost Mode 12VIN to 24VLED 330mA

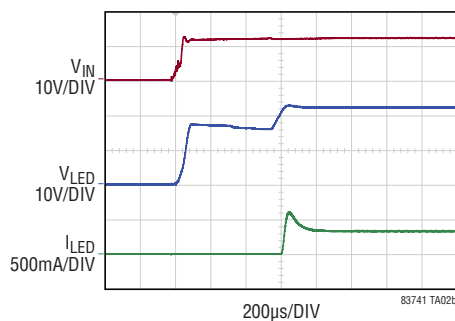

83741 TA02b

TYPICAL APPLICATIONS

LT8374: Low EMI Solution

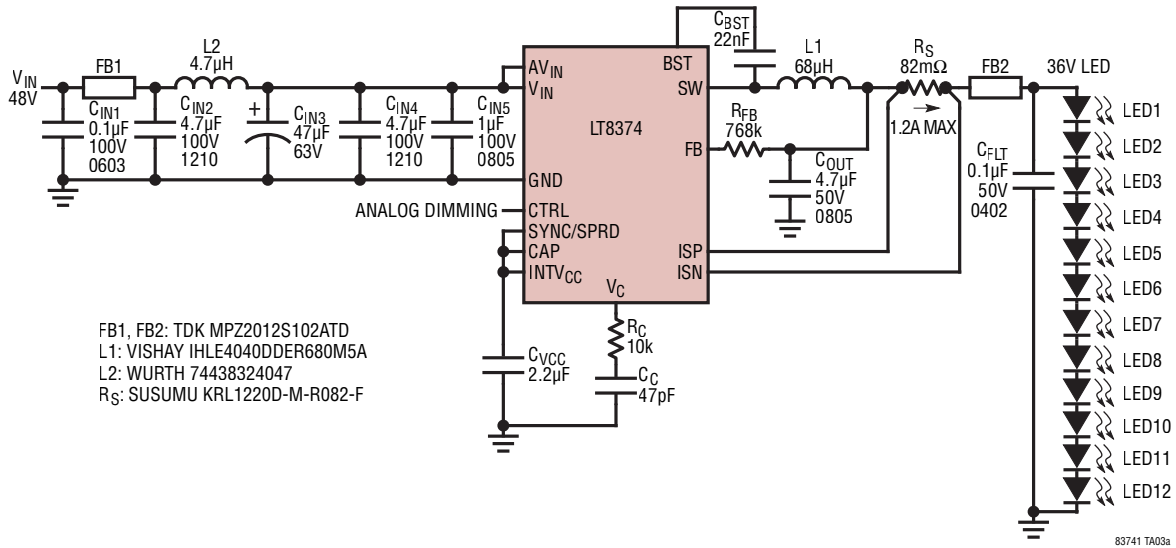

LT8374: CISPR25 Peak Conducted Emissions Test

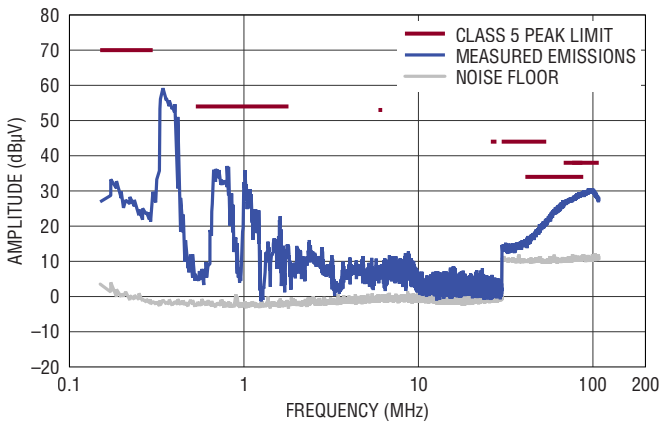

EVAL-LT8374-AZ
48V INPUT TO 36V OUTPUT AT 1.2A

83741 TA03b

LT8374: CISPR25 Average Conducted Emissions Test

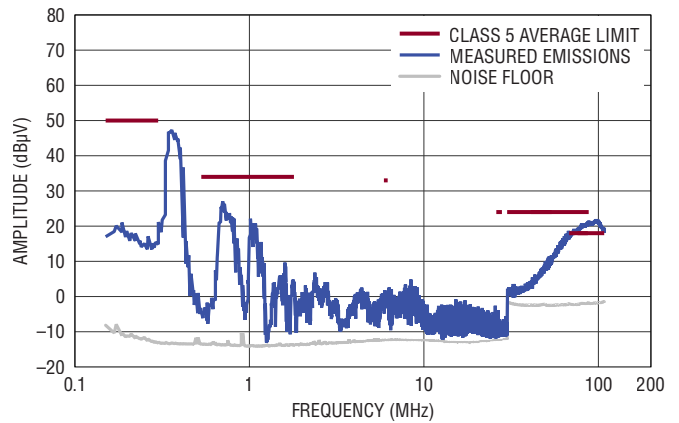

EVAL-LT8374-AZ
48V INPUT TO 36V OUTPUT AT 1.2A

83741 TA03c

LT8374: CISPR25 Average Radiated Emissions Test

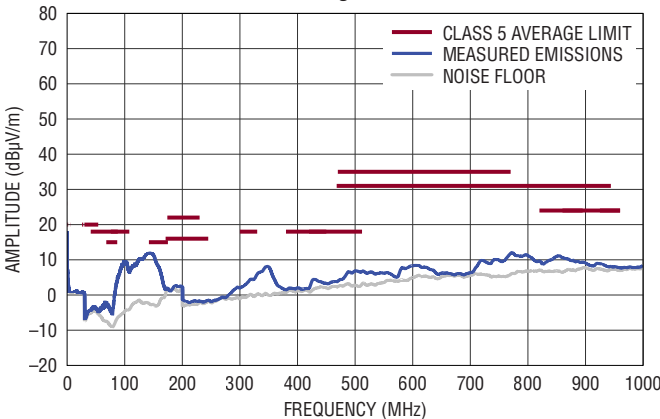

EVAL-LT8374-AZ
48V INPUT TO 36V OUTPUT AT 1.2A

83741 TA03d

LT8374: CISPR25 Peak Radiated Emissions Test

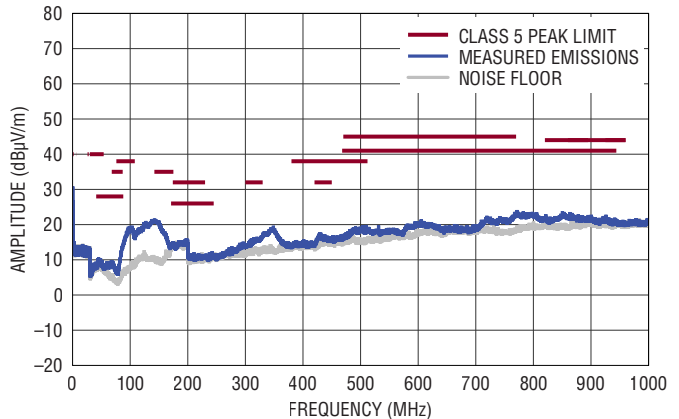

EVAL-LT8374-AZ
48V INPUT TO 36V OUTPUT AT 1.2A

83741 TA03e

TYPICAL APPLICATIONS

LT8374-1: Low EMI Solution

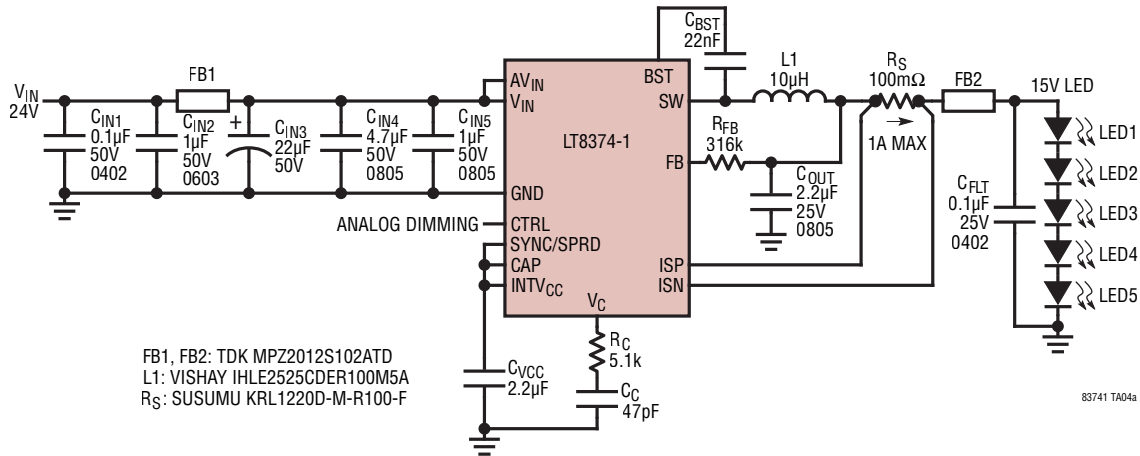

LT8374-1: CISPR25 Peak Conducted Emissions Test

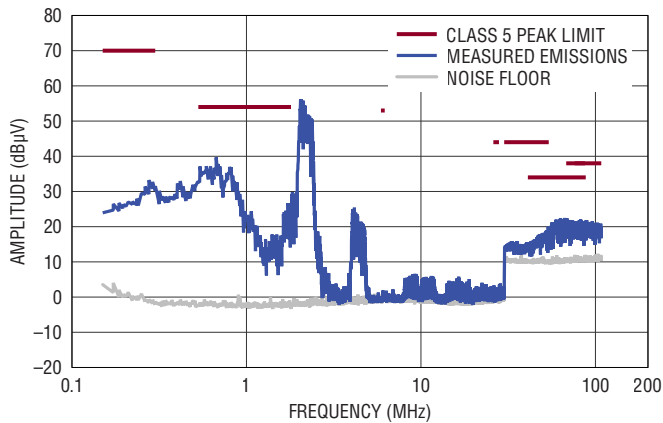

LT8374-1: CISPR25 Average Conducted Emissions Test

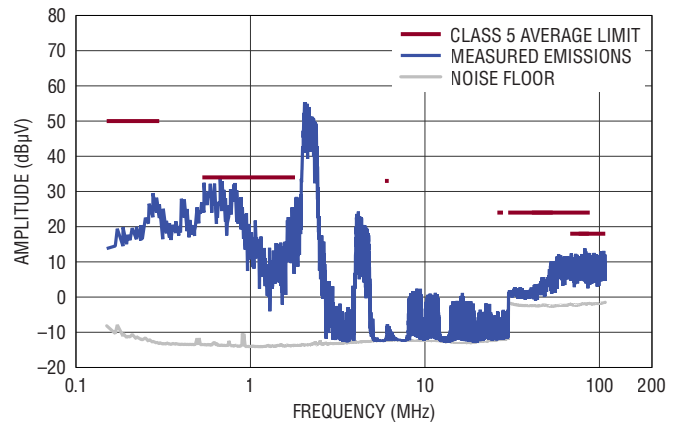

LT8374-1: CISPR25 Average Radiated Emissions Test

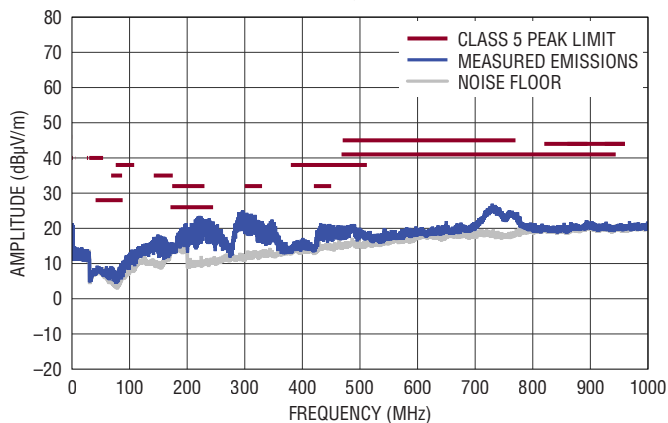

LT8374-1: CISPR25 Peak Radiated Emissions Test

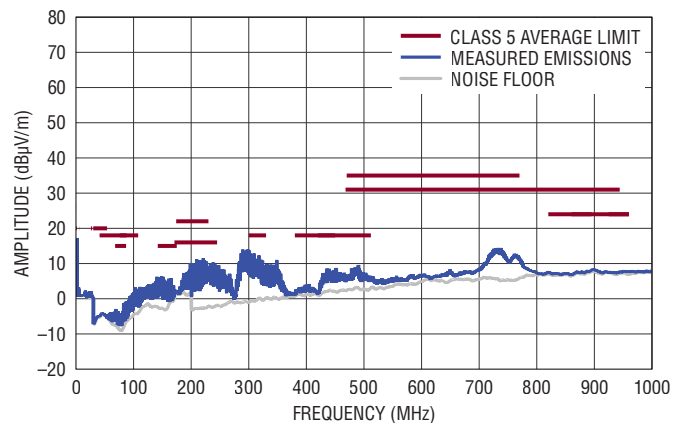

TYPICAL APPLICATIONS

LT8374-1: 1A Buck LED Driver with PWM Dimming

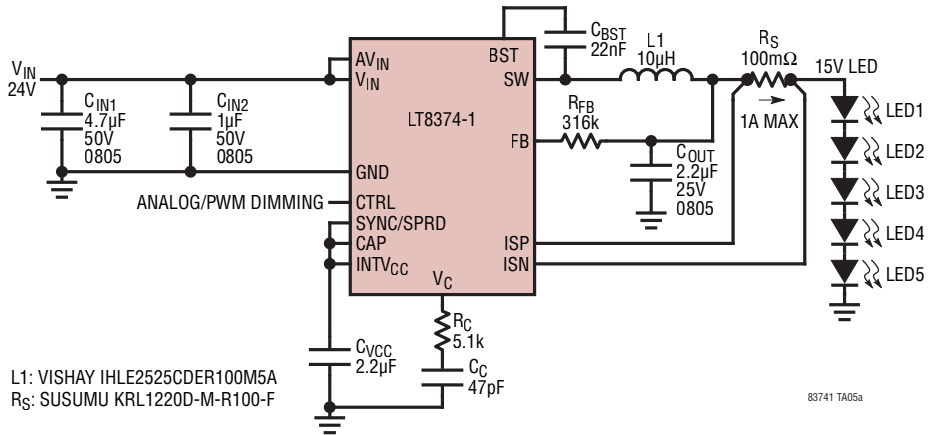

LT8374-1: PWM Dimming

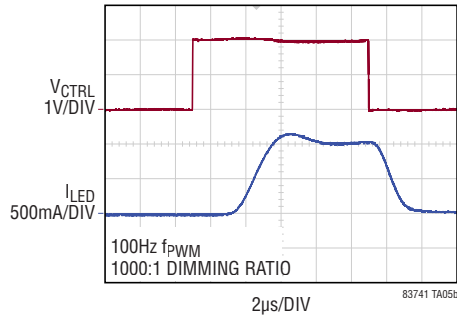

PACKAGE DESCRIPTION

UFM Package 16-Lead Plastic Side Solderable QFN (4mm × 4mm) (Reference DWG # 05-08-1799)

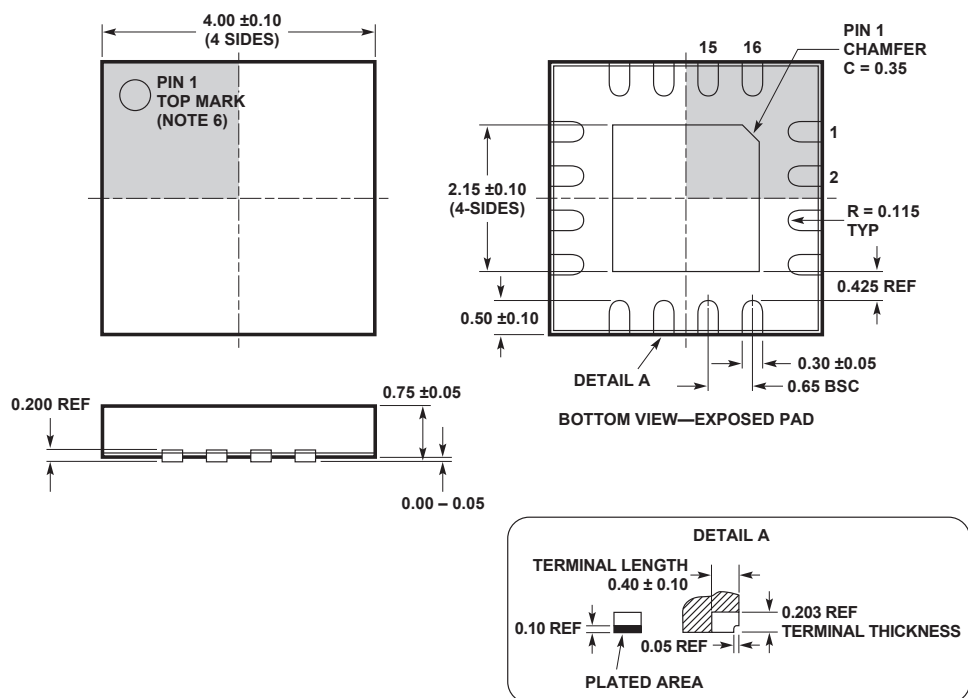

NOTE:

1. DRAWING CONFORMS TO JEDEC PACKAGE OUTLINE MO-220 VARIATION (WGGC)
2. DRAWING NOT TO SCALE
3. ALL DIMENSIONS ARE IN MILLIMETERS
4. DIMENSIONS OF EXPOSED PAD ON BOTTOM OF PACKAGE DO NOT INCLUDE MOLD FLASH. MOLD FLASH, IF PRESENT, SHALL NOT EXCEED 0.15mm ON ANY SIDE
5. EXPOSED PAD SHALL BE SOLDER PLATED
6. SHADED AREA IS ONLY A REFERENCE FOR PIN 1 LOCATION ON THE TOP AND BOTTOM OF PACKAGE

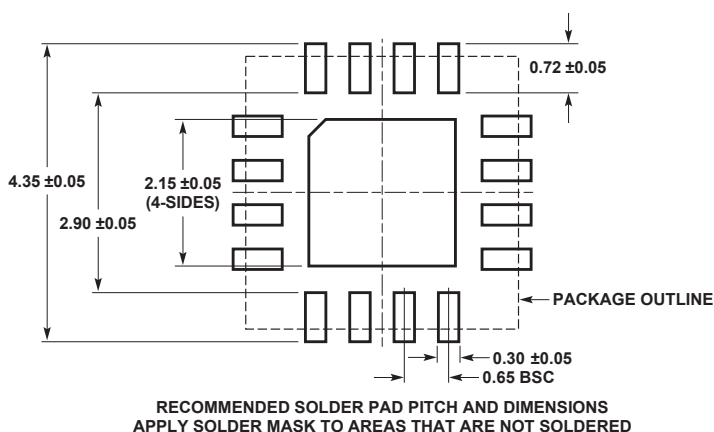

05-10-2022-A