

# Low Power, 8th Order Progressive Elliptic, Lowpass Filter

## FEATURES

- 8th Order Elliptic Filter in SO-8 Package
- Operates from Single 3.3V to  $\pm 5V$  Power Supplies
- $-20dB$  at  $1.2f_{CUTOFF}$
- $-52dB$  at  $1.4f_{CUTOFF}$
- $-70dB$  at  $2f_{CUTOFF}$
- Wide Dynamic Range
- $110\mu V_{RMS}$  Wideband Noise
- $3.8mA$  Supply Current with  $\pm 5V$  Supplies
- $2.5mA$  Supply Current with Single 5V Supply
- $2mA$  Supply Current with Single 3.3V Supply

## APPLICATIONS

- Telecommunication Filters
- Antialiasing Filters

LT, LT, LTC and LTM are registered trademarks of Linear Technology Corporation. All other trademarks are the property of their respective owners.

## DESCRIPTION

The LTC<sup>®</sup>1069-1 is a monolithic 8th order lowpass filter featuring clock-tunable cutoff frequency and 2.5mA power supply current with a single 5V supply. An additional feature of the LTC1069-1 is operation with a single 3.3V supply.

The cutoff frequency ( $f_{CUTOFF}$ ) of the LTC1069-1 is equal to the clock frequency divided by 100. The gain at  $f_{CUTOFF}$  is  $-0.7dB$  and the typical passband ripple is  $\pm 0.15dB$  up to  $0.9f_{CUTOFF}$ . The stopband attenuation of the LTC1069-1 features a progressive elliptic response reaching 20dB attenuation at  $1.2f_{CUTOFF}$ , 52dB attenuation at  $1.4f_{CUTOFF}$  and 70dB attenuation at  $2f_{CUTOFF}$ .

With  $\pm 5V$  supplies, the LTC1069-1 cutoff frequency can be clock-tuned up to 12kHz; with a single 5V supply, the maximum cutoff frequency is 8kHz.

The low power feature of the LTC1069-1 does not penalize the device's dynamic range. With  $\pm 5V$  supplies and an input range of  $0.3V_{RMS}$  to  $2.5V_{RMS}$ , the signal-to-(noise + THD) ratio is  $\geq 70dB$ . The wideband noise of the LTC1069-1 is  $110\mu V_{RMS}$ . *Other filter responses with lower power or higher speed can be obtained. Please contact LTC marketing for details.*

The LTC1069-1 is available in 8-pin PDIP and 8-pin SO packages.

## TYPICAL APPLICATION

Single 3.3V Supply 3kHz Elliptic Lowpass Filter

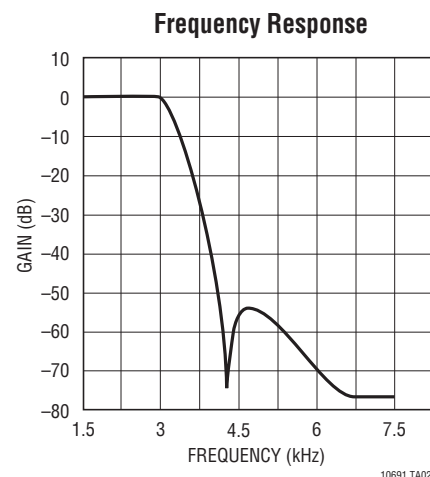
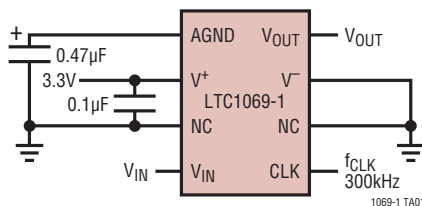

10691fa

# LTC1069-1

## ABSOLUTE MAXIMUM RATINGS

(Note 1)

Total Supply Voltage ( $V^+$  to  $V^-$ ) ..... 12V  
 Maximum Voltage at  
 Any Pin .....  $(V^- - 0.3V) \leq V \leq (V^+ + 0.3V)$

Operating Temperature Range  
 LTC1069C-1 ..... 0°C to 70°C  
 LTC1069I-1 ..... -40°C to 85°C  
 Storage Temperature ..... -65°C to 150°C  
 Lead Temperature (Soldering, 10 sec) ..... 300°C

## PIN CONFIGURATION

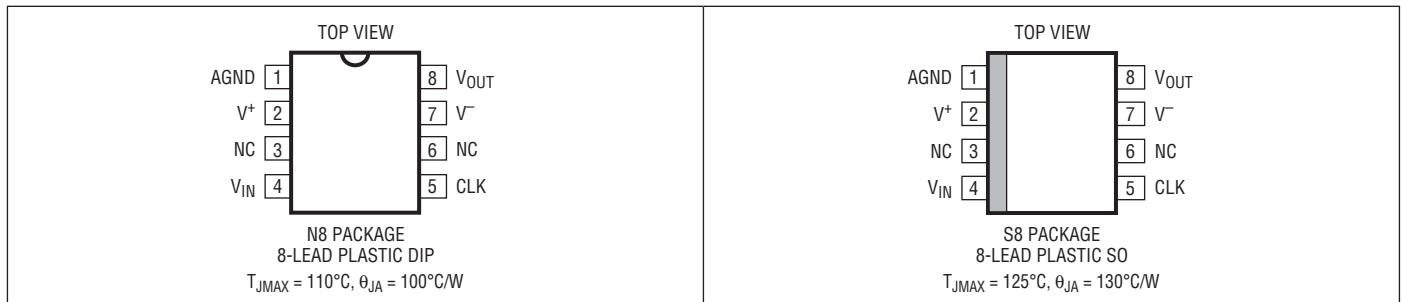

## ORDER INFORMATION

LEAD FREE FINISH	TAPE AND REEL	PART MARKING*	PACKAGE DESCRIPTION	SPECIFIED TEMPERATURE RANGE
LTC1069-1CN8#PBF		LTC1069-1	8-Lead Plastic DIP	0°C to 70°C
LTC1069-1IN8#PBF		LTC1069-1	8-Lead Plastic DIP	-40°C to 85°C
LTC1069-1CS8#PBF	LTC1069-1CS8#TRPBF	10691	8-Lead Plastic SO	0°C to 70°C
LTC1069-1IS8#PBF	LTC1069-1IS8#TRPBF	10691I	8-Lead Plastic SO	-40°C to 85°C

Consult LTC Marketing for parts specified with wider operating temperature ranges. \*The temperature grade is identified by a label on the shipping container. Consult LTC Marketing for information on non-standard lead based finish parts.

For more information on lead free part marking, go to: <http://www.linear.com/leadfree/>

For more information on tape and reel specifications, go to: <http://www.linear.com/tapeandreel/>

**ELECTRICAL CHARACTERISTICS** The ● denotes the specifications which apply over the full operating temperature range, otherwise specifications are at  $T_A = 25^\circ\text{C}$ .  $f_{\text{CUTOFF}}$  is the filter's cutoff frequency and is equal to  $f_{\text{CLK}}/100$ . The  $f_{\text{CLK}}$  signal level is TTL or CMOS (clock rise or fall time  $\leq 1\mu\text{s}$ ),  $V_S = 3.3\text{V}$  to  $\pm 5\text{V}$ ,  $R_L = 10\text{k}$ , unless otherwise noted. All AC gains are measured relative to the passband gain.

PARAMETER	CONDITIONS	MIN	TYP	MAX	UNITS
Passband Gain ( $f_{\text{IN}} \leq 0.25f_{\text{CUTOFF}}$ )	$V_S = \pm 5\text{V}$ , $f_{\text{CLK}} = 500\text{kHz}$ $f_{\text{TEST}} = 1.25\text{kHz}$ , $V_{\text{IN}} = 1V_{\text{RMS}}$	-0.30 ● -0.35	0.2	0.70 0.75	dB dB
	$V_S = 3.3\text{V}$ , $f_{\text{CLK}} = 200\text{kHz}$ $f_{\text{TEST}} = 0.5\text{kHz}$ , $V_{\text{IN}} = 0.5V_{\text{RMS}}$	-0.30 ● -0.35	0.2	0.70 0.75	dB dB

**ELECTRICAL CHARACTERISTICS** The ● denotes the specifications which apply over the full operating temperature range, otherwise specifications are at  $T_A = 25^\circ\text{C}$ .  $f_{\text{CUTOFF}}$  is the filter's cutoff frequency and is equal to  $f_{\text{CLK}}/100$ . The  $f_{\text{CLK}}$  signal level is TTL or CMOS (clock rise or fall time  $\leq 1\mu\text{s}$ ),  $V_S = 3.3\text{V}$  to  $\pm 5\text{V}$ ,  $R_L = 10\text{k}$ , unless otherwise noted. All AC gains are measured relative to the passband gain.

PARAMETER	CONDITIONS	MIN	TYP	MAX	UNITS
Gain at $0.50f_{\text{CUTOFF}}$	$V_S = \pm 5\text{V}$ , $f_{\text{CLK}} = 500\text{kHz}$ $f_{\text{TEST}} = 2.5\text{kHz}$ , $V_{\text{IN}} = 1V_{\text{RMS}}$	● -0.10 -0.11	-0.03	0.10 0.11	dB dB
	$V_S = 3.3\text{V}$ , $f_{\text{CLK}} = 200\text{kHz}$ $f_{\text{TEST}} = 1\text{kHz}$ , $V_{\text{IN}} = 0.5V_{\text{RMS}}$	● -0.10 -0.11	-0.03	0.10 0.11	dB dB
Gain at $0.75f_{\text{CUTOFF}}$	$V_S = \pm 5\text{V}$ , $f_{\text{CLK}} = 500\text{kHz}$ $f_{\text{TEST}} = 3.75\text{kHz}$ , $V_{\text{IN}} = 1V_{\text{RMS}}$	● -0.20 -0.25	0.04	0.20 0.25	dB dB
	$V_S = 3.3\text{V}$ , $f_{\text{CLK}} = 200\text{kHz}$ $f_{\text{TEST}} = 1.5\text{kHz}$ , $V_{\text{IN}} = 0.5V_{\text{RMS}}$	● -0.20 -0.25	0.04	0.20 0.25	dB dB
Gain at $0.90f_{\text{CUTOFF}}$	$V_S = \pm 5\text{V}$ , $f_{\text{CLK}} = 500\text{kHz}$ $f_{\text{TEST}} = 4.5\text{kHz}$ , $V_{\text{IN}} = 1V_{\text{RMS}}$	● -0.20 -0.25	-0.01	0.20 0.25	dB dB
	$V_S = 3.3\text{V}$ , $f_{\text{CLK}} = 200\text{kHz}$ $f_{\text{TEST}} = 1.8\text{kHz}$ , $V_{\text{IN}} = 0.5V_{\text{RMS}}$	● -0.20 -0.25	-0.01	0.20 0.25	dB dB
Gain at $0.95f_{\text{CUTOFF}}$	$V_S = \pm 5\text{V}$ , $f_{\text{CLK}} = 500\text{kHz}$ $f_{\text{TEST}} = 4.75\text{kHz}$ , $V_{\text{IN}} = 1V_{\text{RMS}}$	● -0.30 -0.35	-0.05	0.30 0.35	dB dB
	$V_S = 3.3\text{V}$ , $f_{\text{CLK}} = 200\text{kHz}$ $f_{\text{TEST}} = 1.9\text{kHz}$ , $V_{\text{IN}} = 0.5V_{\text{RMS}}$	● -0.30 -0.35	-0.04	0.30 0.35	dB dB
Gain at $f_{\text{CUTOFF}}$	$V_S = \pm 5\text{V}$ , $f_{\text{CLK}} = 500\text{kHz}$ $f_{\text{TEST}} = 5.0\text{kHz}$ , $V_{\text{IN}} = 1V_{\text{RMS}}$	● -1.25 -1.35	-0.70	-0.25 -0.15	dB dB
	$V_S = 3.3\text{V}$ , $f_{\text{CLK}} = 200\text{kHz}$ $f_{\text{TEST}} = 2.0\text{kHz}$ , $V_{\text{IN}} = 0.5V_{\text{RMS}}$	● -1.25 -1.35	-0.61	-0.25 -0.15	dB dB
Gain at $1.25f_{\text{CUTOFF}}$	$V_S = \pm 5\text{V}$ , $f_{\text{CLK}} = 500\text{kHz}$ $f_{\text{TEST}} = 6.25\text{kHz}$ , $V_{\text{IN}} = 1V_{\text{RMS}}$	● -30 -31	-27	-25 -24	dB dB
	$V_S = 3.3\text{V}$ , $f_{\text{CLK}} = 200\text{kHz}$ $f_{\text{TEST}} = 2.5\text{kHz}$ , $V_{\text{IN}} = 0.5V_{\text{RMS}}$	● -30 -31	-27	-25 -24	dB dB
Gain at $1.50f_{\text{CUTOFF}}$	$V_S = \pm 5\text{V}$ , $f_{\text{CLK}} = 500\text{kHz}$ $f_{\text{TEST}} = 7.5\text{kHz}$ , $V_{\text{IN}} = 1V_{\text{RMS}}$	● -58 -59	-53	-50 -49	dB dB
	$V_S = 3.3\text{V}$ , $f_{\text{CLK}} = 200\text{kHz}$ $f_{\text{TEST}} = 3\text{kHz}$ , $V_{\text{IN}} = 0.5V_{\text{RMS}}$	● -58 -59	-53	-50 -49	dB dB
Output DC Offset (Input at AGND)	$V_S = \pm 5\text{V}$ , $f_{\text{CLK}} = 500\text{kHz}$		30	150	mV
	$V_S = 4.75\text{V}$ , $f_{\text{CLK}} = 400\text{kHz}$		20		mV
	$V_S = 3.3\text{V}$ , $f_{\text{CLK}} = 200\text{kHz}$		15	100	mV
Output Voltage Swing	$V_S = \pm 5\text{V}$	● -3.25	$\pm 4.0$	3.25	V
	$V_S = 4.75\text{V}$	● -1.50	$\pm 1.7$	1.25	V
	$V_S = 3.3\text{V}$	● -0.70	$\pm 0.9$	0.60	V
Power Supply Current	$V_S = \pm 5\text{V}$ , $f_{\text{CLK}} = 500\text{kHz}$	●	3.8	5.5	mA
	$V_S = 4.75\text{V}$ , $f_{\text{CLK}} = 400\text{kHz}$	●	2.5	4.5	mA
	$V_S = 3.3\text{V}$ , $f_{\text{CLK}} = 200\text{kHz}$	●	2.0	3.5	mA
Maximum Clock Frequency	$V_S = \pm 5\text{V}$		1.2		MHz
	$V_S = 4.75\text{V}$		0.8		MHz
	$V_S = 3.3\text{V}$		0.5		MHz
Input Frequency Range		0		$f_{\text{CLK}}/2$	MHz
Input Resistance		30	43	70	$\text{k}\Omega$
Operating Power Supply Voltage		$\pm 1.57$		$\pm 5.5$	V

**Note 1:** Stresses beyond those listed under Absolute Maximum Ratings may cause permanent damage to the device. Exposure to any Absolute Maximum Rating condition for extended periods may affect device reliability and lifetime.

TYPICAL PERFORMANCE CHARACTERISTICS

Passband Gain vs Frequency

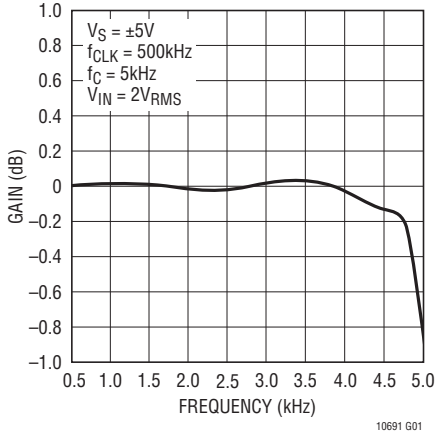

10691 G01

Transition Band Gain vs Frequency

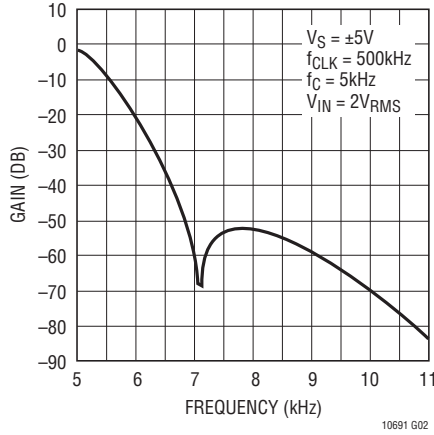

10691 G02

Stopband Gain vs Frequency

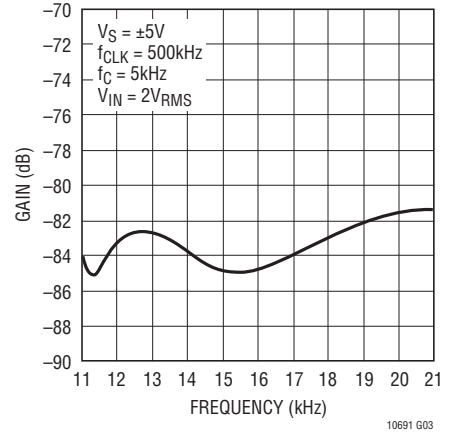

10691 G03

Passband Gain vs Clock Frequency, VS = Single 3.3V

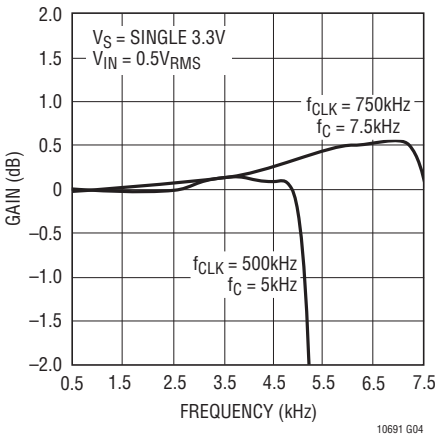

10691 G04

Passband Gain vs Clock Frequency, VS = Single 5V

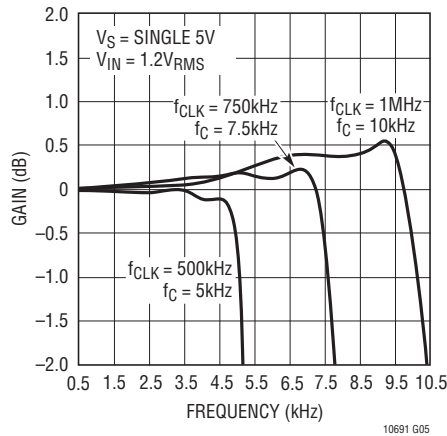

10691 G05

Passband Gain vs Clock Frequency, VS = ±5V

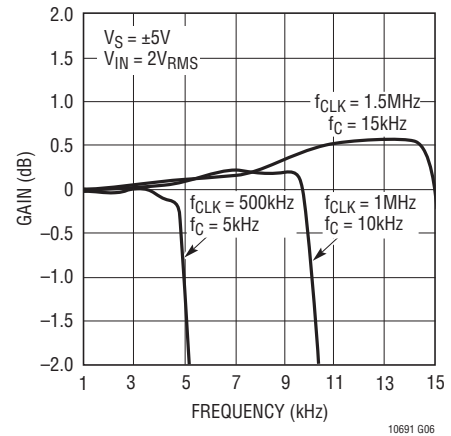

10691 G06

Gain vs Supply Voltage

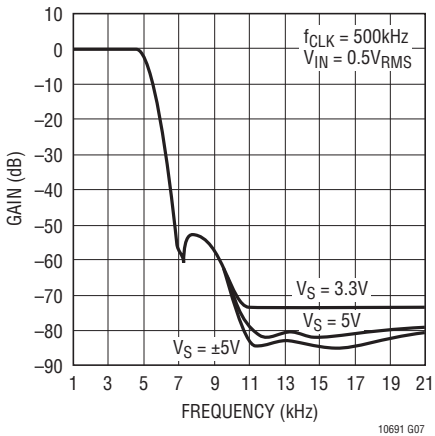

10691 G07

Phase and Group Delay vs Frequency

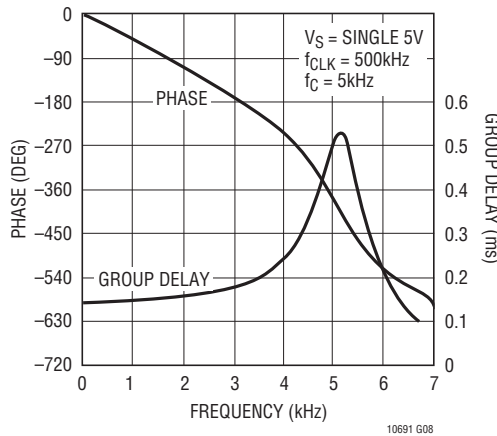

10691 G08

Transient Response

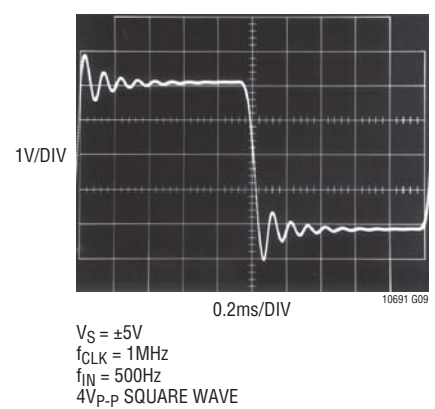

10691 G09

# TYPICAL PERFORMANCE CHARACTERISTICS

**Dynamic Range**  
**THD + Noise vs  $V_{IN}$  ( $V_{RMS}$ )**

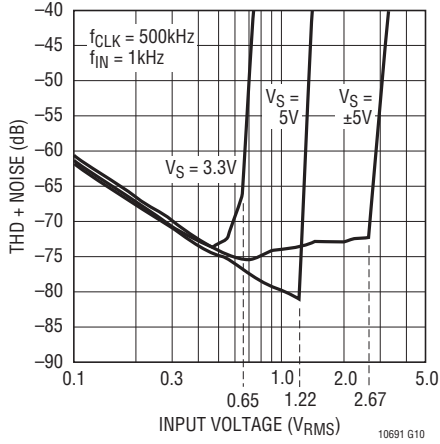

10691 G10

**THD + Noise vs Frequency**

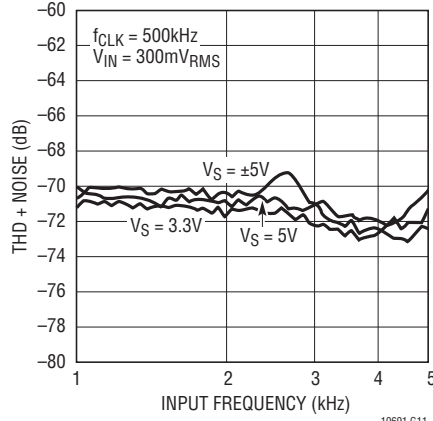

10691 G11

**THD + Noise vs Frequency**

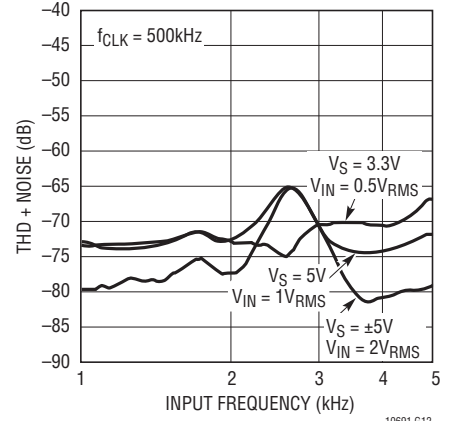

10691 G12

**Supply Current vs Supply Voltage**

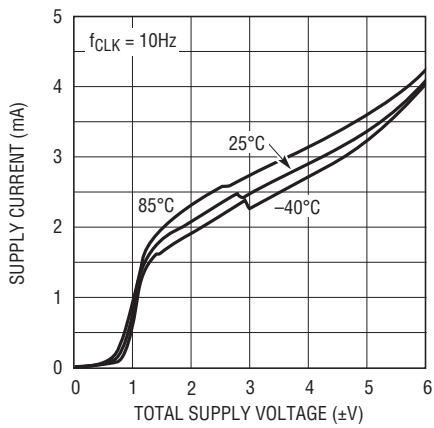

10691 G13

**Supply Current vs Clock Frequency**

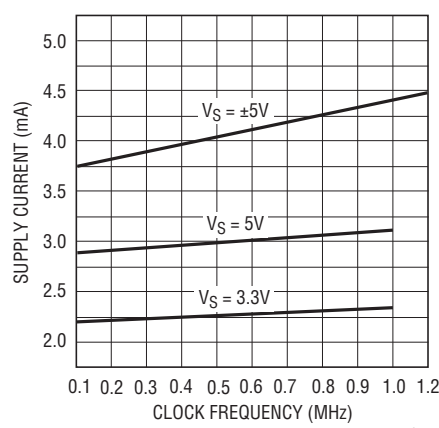

10691 G14

**Output Voltage Swing vs Temperature**

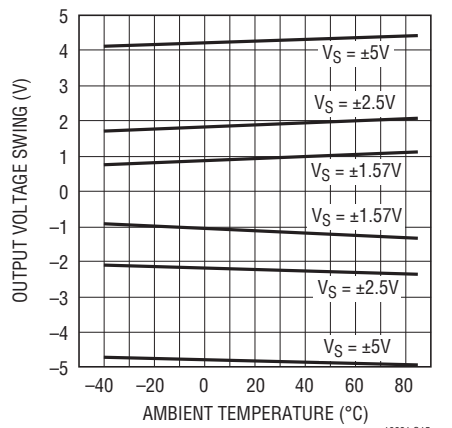

10691 G15

## PIN FUNCTIONS

**AGND (Pin 1):** Analog Ground. The quality of the analog signal ground can affect the filter performance. For either single or dual supply operation, an analog ground plane surrounding the package is recommended. The analog ground plane should be connected to any digital ground at a single point. For dual supply operation Pin 1 should be connected to the analog ground plane.

For single supply operation Pin 1 should be bypassed to the analog ground plane with a 0.47 $\mu$ F or larger capacitor. An internal resistive divider biases Pin 1 to 1/2 the total power supply. Pin 1 should be buffered if used to bias other ICs. Figure 1 shows the connections for single supply operation.

**V<sup>+</sup>, V<sup>-</sup> (Pins 2, 7):** Power Supply Pins. The V<sup>+</sup> (Pin 2) and the V<sup>-</sup> (Pin 7) should be bypassed with a 0.1 $\mu$ F capacitor to an adequate analog ground. The filter's power supplies should be isolated from other digital or high voltage analog supplies. A low noise linear supply is recommended. Using switching power supplies will lower the signal-to-noise ratio of the filter. Unlike previous monolithic filters, the power supplies can be applied at any order, that is, the positive supply can be applied before the negative supply and vice versa. Figure 2 shows the connection for dual supply operation.

**NC (Pins 3, 6):** No Connection. Pins 3 and 6 are not connected to any internal circuitry; they should be preferably tied to ground.

**V<sub>IN</sub> (Pin 4):** Filter Input Pin. The filter input pin is internally connected to the inverting input of an op amp through a 43k resistor.

**CLK (Pin 5):** Clock Input Pin. Any TTL or CMOS clock source with a square wave output and 50% duty cycle ( $\pm 10\%$ ) is an adequate clock source for the device. The power supply for the clock source should not necessarily be the filter's power supply. The analog ground of the filter should be connected to clock's ground at a single point only. Table 1 shows the clock's low and high level threshold value for a dual or a single supply operation. A pulse generator can be used as a clock source provided the high level ON time is greater than 0.42 $\mu$ s ( $V_S = \pm 5V$ ). Sine waves less than 100kHz are not recommended for clock signal because excessive slow clock rise or fall times generate internal clock jitter. The maximum clock rise or fall is 1 $\mu$ s. The clock signal should be routed from the right side of the IC package to avoid coupling into any input or output analog signal path. A 1k resistor between the clock source and the clock input pin (5) will slow down the rise and fall times of the clock to further reduce charge coupling, Figure 1.

**Table 1. Clock Source High and Low Thresholds**

POWER SUPPLY	HIGH LEVEL	LOW LEVEL
Dual Supply = $\pm 5V$	1.5V	0.5V
Single Supply = 10V	6.5V	5.5V
Single Supply = 5V	1.5V	0.5V
Single Supply = 3.3V	1.2V	0.5V

**V<sub>OUT</sub> (Pin 8):** Filter Output Pin. Pin 8 is the output of the filter and it can source or sink 1mA. Driving coaxial cables or resistive loads less than 20k will degrade the total harmonic distortion of the filter. When evaluating the device's dynamic range, a buffer is required to isolate the filter's output from coax cables and instruments.

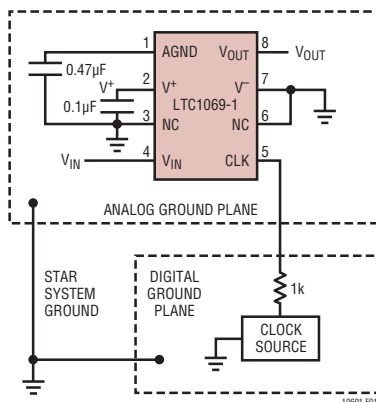

**Figure 1. Connections for Single Supply Operation**

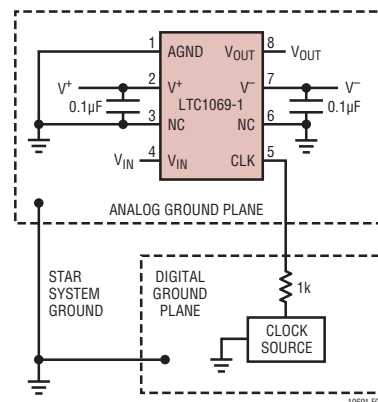

**Figure 2. Connections for Dual Supply Operation**

## APPLICATIONS INFORMATION

### Temperature Behavior

The power supply current of the LTC1069-1 has a positive temperature coefficient. The GBW product of its internal op amps is nearly constant and the speed of the device does not degrade at high temperatures. Figures 3a, 3b and 3c show the behavior of the maximum passband of the device for various supplies and temperatures. The filter, especially at  $\pm 5V$  supply, has a passband behavior which is nearly temperature independent.

### Clock Feedthrough

The clock feedthrough is defined as the RMS value of the clock frequency and its harmonics that are present at the filter's output pin (8). The clock feedthrough is tested with the input pin (4) shorted to the AGND pin and depends on PC board layout and on the value of the power supplies. With proper layout techniques the values of the clock feedthrough are shown on Table 2.

**Table 2. Clock Feedthrough**

$V_S$	CLOCK FEEDTHROUGH
3.3V	$10\mu V_{RMS}$
5V	$40\mu V_{RMS}$
$\pm 5V$	$160\mu V_{RMS}$

Any parasitic switching transients during the rise and fall edges of the incoming clock are not part of the clock feedthrough specifications. Switching transients have frequency contents much higher than the applied clock; their amplitude strongly depends on scope probing techniques as well as grounding and power supply bypassing. The clock feedthrough can be reduced, if bothersome, by adding a single RC lowpass filter at the output pin (8) of the LTC1069-1.

### Wideband Noise

The wideband noise of the filter is the total RMS value of the device's noise spectral density and determines the operating signal-to-noise ratio. Most of the wideband noise frequency contents lie within the filter passband. The wideband noise cannot be reduced by adding post filtering. The total wideband noise is nearly independent of the clock frequency and depends slightly on the power supply voltage (see Table 3). The clock feedthrough specifications are not part of the wideband noise.

**Table 3. Wideband Noise**

$V_S$	WIDEBAND NOISE
3.3V	$100\mu V_{RMS}$
5V	$108\mu V_{RMS}$
$\pm 5V$	$112\mu V_{RMS}$

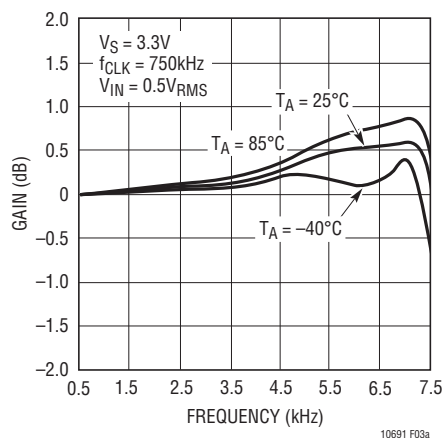

**Figure 3a**

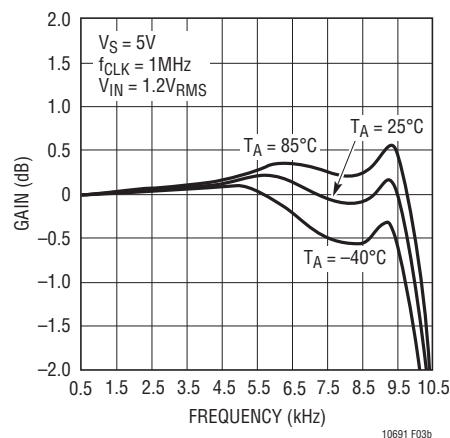

**Figure 3b**

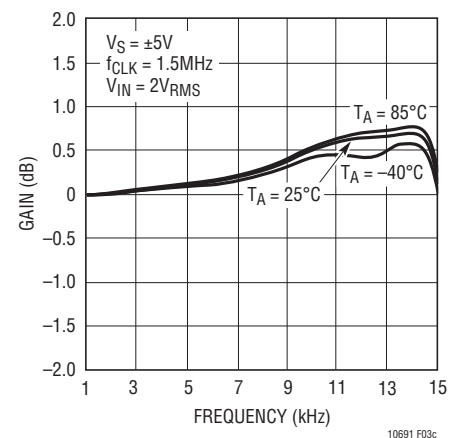

**Figure 3c**

## APPLICATIONS INFORMATION

### Aliasing

Aliasing is an inherent phenomenon of sampled data systems and it occurs for input frequencies approaching the sampling frequency. The internal sampling frequency of the LTC1069-1 is 100 times its cutoff frequency. For instance, if a 98kHz, 100mV<sub>RMS</sub> signal is applied at the input of an LTC1069-1 operating with a 100kHz clock, a 2kHz, 28μV<sub>RMS</sub> alias signal will appear at the filter output. Table 4 shows details.

Table 4. Aliasing ( $f_{CLK} = 100\text{kHz}$ )

INPUT FREQUENCY ( $V_{IN} = 1V_{RMS}$ ) (kHz)	OUTPUT LEVEL (Relative to Input) (dB)	OUTPUT FREQUENCY (Aliased Frequency) (kHz)
$f_{CLK}/f_C = 100:1$ , $f_{CUTOFF} = 1\text{kHz}$		
96 (or 104)	-90.0	4.0
97 (or 103)	-86.0	3.0
98 (or 102)	-71.0	2.0
98.5 (or 101.5)	-56.0	1.5
99 (or 101)	-1.1	1.0
99.5 (or 100.5)	-0.21	0.5

## TYPICAL APPLICATIONS

Single 5V Operation with Power Shutdown

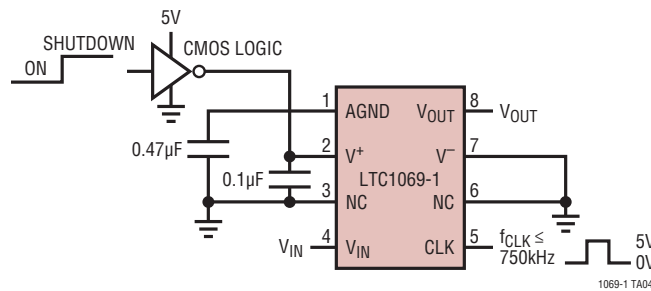

Single 3.3V Supply Operation with Output Buffer

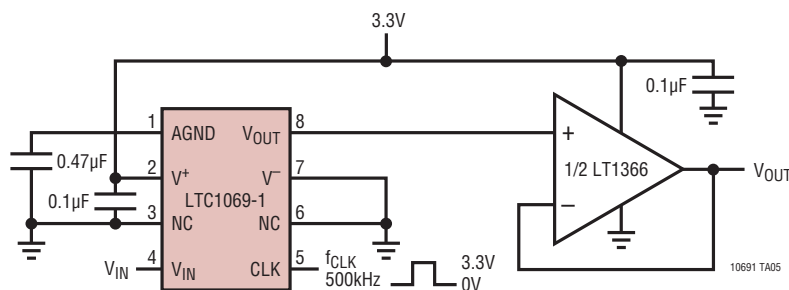



# PACKAGE DESCRIPTION

## N Package 8-Lead PDIP (Narrow .300 Inch) (Reference LTC DWG # 05-08-1510)

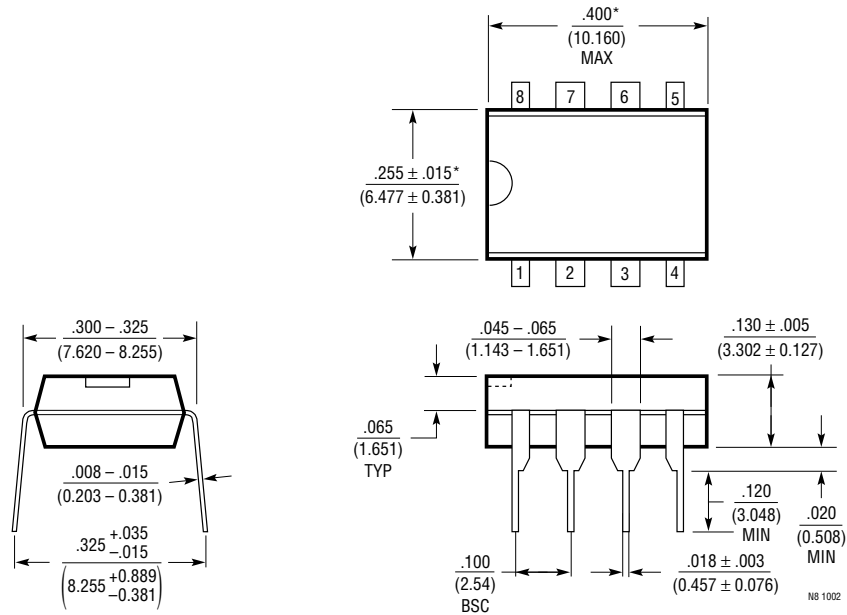

NOTE:  
1. DIMENSIONS ARE  $\frac{\text{INCHES}}{\text{MILLIMETERS}}$   
\*THESE DIMENSIONS DO NOT INCLUDE MOLD FLASH OR PROTRUSIONS.  
MOLD FLASH OR PROTRUSIONS SHALL NOT EXCEED .010 INCH (0.254mm)

## S8 Package 8-Lead Plastic Small Outline (Narrow .150 Inch) (Reference LTC DWG # 05-08-1610)

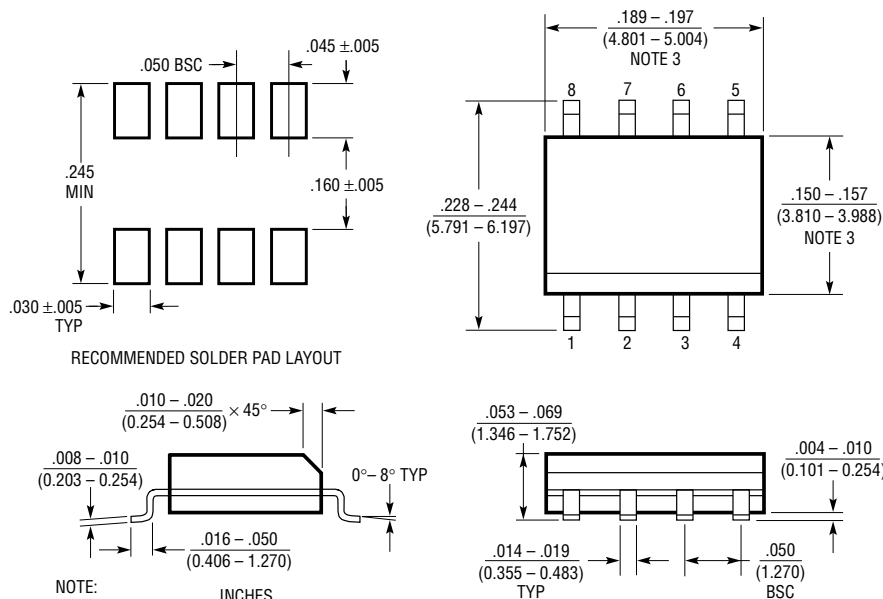

NOTE:  
1. DIMENSIONS IN  $\frac{\text{INCHES}}{\text{MILLIMETERS}}$   
2. DRAWING NOT TO SCALE  
3. THESE DIMENSIONS DO NOT INCLUDE MOLD FLASH OR PROTRUSIONS.  
MOLD FLASH OR PROTRUSIONS SHALL NOT EXCEED .006" (0.15mm)

S08 0303

10691fa