

3.3V Low Power EIA/TIA-562 3-Driver/ 5-Receiver Transceiver

FEATURES

- **Low Supply Current: 300 μ A**
- **Receivers 4 and 5 Kept Alive in Shutdown: 35 μ A**
- **ESD Protection: \pm 10kV**
- **Operates from a Single 3.3V Supply**
- **Uses Small Capacitors: 0.1 μ F**
- **Operates to 120kBaud**
- **Three-State Outputs are High Impedance When Off**
- **Output Overvoltage Does Not Force Current Back into Supplies**
- **EIA/TIA-562 I/O Lines Can Be Forced to \pm 25V Without Damage**
- **Flowthrough Architecture**

APPLICATIONS

- Notebook Computers
- Palmtop Computers

DESCRIPTION

The LTC[®]1350 is a 3-driver/5-receiver EIA/TIA-562 transceiver with very low supply current. In the no load condition, the supply current is only 300 μ A. The charge pump only requires four 0.1 μ F capacitors.

In Shutdown mode, two receivers are kept alive and the supply current is only 35 μ A. All RS232 outputs assume a high impedance state in Shutdown or with the power off.

The LTC1350 is fully compliant with all data rate and overvoltage EIA/TIA-562 specifications. The transceiver can operate up to 120kbaud with a 1000pF and 3k Ω load. Both driver outputs and receiver inputs can be forced to \pm 25V without damage and can survive multiple \pm 10kV ESD strikes.

LT, LTC and LT are registered trademarks of Linear Technology Corporation.

TYPICAL APPLICATION

3-Drivers/5-Receivers with Shutdown

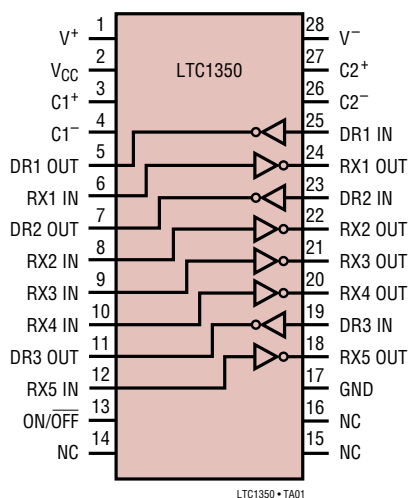

Quiescent and Shutdown Supply Current vs Temperature

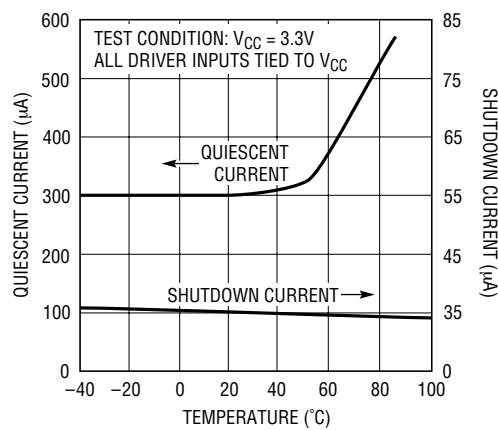

ABSOLUTE MAXIMUM RATINGS

Supply Voltage (V_{CC})	5V
Input Voltage	
Driver	-0.3V to $V_{CC} + 0.3V$
Receiver	-25V to 25V
ON/OFF Pin	-0.3V to $V_{CC} + 0.3V$
Output Voltage	
Driver	-25V to 25V
Receiver	-0.3V to $V_{CC} + 0.3V$
Short-Circuit Duration	
V^+	30 sec
V^-	30 sec
Driver Output	Indefinite
Receiver Output	Indefinite
Operating Temperature Range	
Commercial (LTC1350C)	0°C to 70°C
Industrial (LTC1350I)	-40°C to 85°C
Storage Temperature Range	-65°C to 150°C
Lead Temperature (Soldering, 10 sec)	300°C

PACKAGE/ORDER INFORMATION

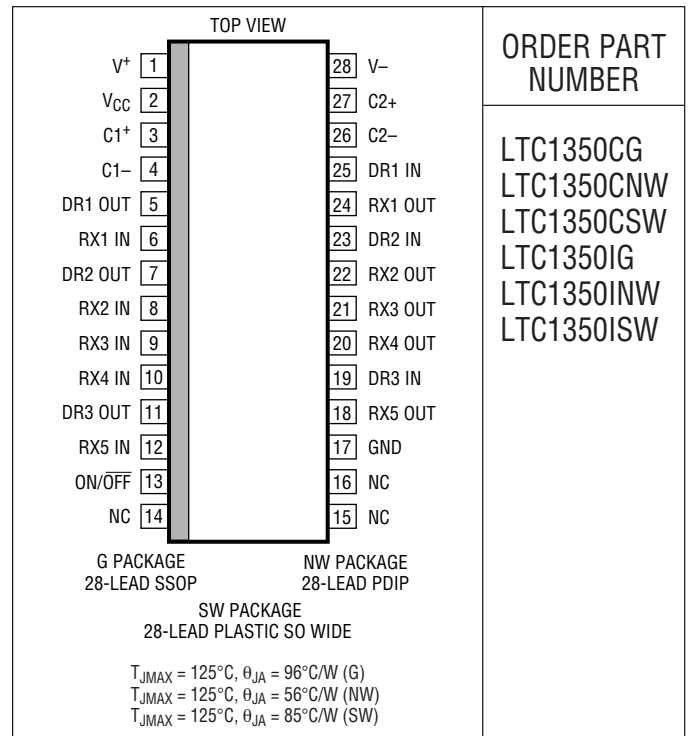

ORDER PART NUMBER

LTC1350CG
LTC1350CNW
LTC1350CSW
LTC1350IG
LTC1350INW
LTC1350ISW

Consult LTC Marketing for parts specified with wider operating temperature ranges.

DC ELECTRICAL CHARACTERISTICS

The ● denotes specifications which apply over the full operating temperature range. $V_{CC} = 3.3V$, $C1 = C2 = C3 = C4 = 0.1\mu F$, unless noted.

PARAMETER	CONDITIONS	MIN	TYP	MAX	UNITS
Any Driver					
Output Voltage Swing	3k to GND	Positive ● Negative ●	3.7 4.5	4.5 -4.5	V V
Logic Input Voltage Level	Input Low Level ($V_{OUT} = \text{High}$) Input High Level ($V_{OUT} = \text{Low}$)	● ●	1.4 2.0	0.8 1.4	V V
Logic Input Current	$V_{IN} = V_{CC}$ $V_{IN} = 0V$	● ●		5 -5	μA μA
Output Short-Circuit Current	$V_{OUT} = 0V$		±9	±10	mA
Output Leakage Current	Shutdown (Note 3), $V_{OUT} = \pm 20V$		10	500	μA
Any Receiver					
Input Voltage Thresholds	Input Low Threshold Input High Threshold	● ●	0.8	1.3 1.7 2.4	V V
Hysteresis		●	0.1	0.4 1	V
Input Resistance	$V_{IN} = \pm 10V$		3	5 7	k Ω
Output Voltage	Output Low, $I_{OUT} = -1.6mA$ ($V_{CC} = 3.3V$) Output High, $I_{OUT} = 160\mu A$ ($V_{CC} = 3.3V$)	● ●	3.0	0.2 3.2	V V
Output Short-Circuit Current	Sinking Current, $V_{OUT} = V_{CC}$		-3	-20	mA
Output Leakage Current	Shutdown (Note 3), $0V \leq V_{OUT} \leq V_{CC}$	●	1	10	μA

DC ELECTRICAL CHARACTERISTICS

The ● denotes specifications which apply over the full operating temperature range. $V_{CC} = 3.3V$, $C1 = C2 = C3 = C4 = 0.1\mu F$, unless noted.

PARAMETER	CONDITIONS	MIN	TYP	MAX	UNITS
Power Supply Generator					
V^+ Output Voltage	$I_{OUT} = 0mA$		5.7		V
	$I_{OUT} = 5mA$		5.5		V
V^- Output Voltage	$I_{OUT} = 0mA$		-5.3		V
	$I_{OUT} = -5mA$		-5.0		V
Supply Rise Time	Shutdown to Turn-On		0.2		ms
Power Supply					
V_{CC} Supply Current	No Load (All Drivers $V_{IN} = V_{CC}$)(Note 2) $0^\circ C \leq T_A \leq 70^\circ C$	●	0.3	0.6	mA
	No Load (All Drivers $V_{IN} = 0$)(Note 2) $0^\circ C \leq T_A \leq 70^\circ C$	●	0.5	1.0	mA
	No Load (All Drivers $V_{IN} = V_{CC}$)(Note 2) $0^\circ C \leq T_A \leq 85^\circ C$	●	0.3	1.0	mA
	No Load (All Drivers $V_{IN} = V_{CC}$)(Note 2) $-40^\circ C \leq T_A \leq 0^\circ C$	●	0.3	1.5	mA
	No Load (All Drivers $V_{IN} = 0$)(Note 2) $-40^\circ C \leq T_A \leq 85^\circ C$	●	0.5	1.5	mA
	Shutdown (Note 3)	●	35	50	μA
ON/OFF Threshold Low		●	1.4	0.8	V
ON/OFF Threshold High		●	2.0	1.4	V

AC CHARACTERISTICS

The ● denotes specifications which apply over the full operating temperature range. $V_{CC} = 5V$, $C1 = C2 = C3 = C4 = 0.1\mu F$, unless noted.

PARAMETER	CONDITIONS	MIN	TYP	MAX	UNITS
Slew Rate	$R_L = 3k, C_L = 51pF$		8	30	V/ μS
	$R_L = 3k, C_L = 1000pF$	3	5		V/ μS
Driver Propagation Delay (TTL to EIA/TIA-562)	t_{HLD} (Figure 1)	●	2	3.5	μS
	t_{LHD} (Figure 1)	●	2	3.5	μS
Receiver Propagation Delay (EIA/TIA-562 to TTL)	t_{HLR} (Figure 2)	●	0.3	0.8	μS
	t_{LHR} (Figure 2)	●	0.3	0.8	μS

Note 1: Absolute Maximum Ratings are those values beyond which the life of the device may be impaired.

Note 2: Supply current is measured with driver and receiver outputs unloaded.

Note 3: Supply current measurement in Shutdown mode is performed with $V_{ON/OFF} = 0V$.

TYPICAL PERFORMANCE CHARACTERISTICS

Driver Output Voltage vs Temperature

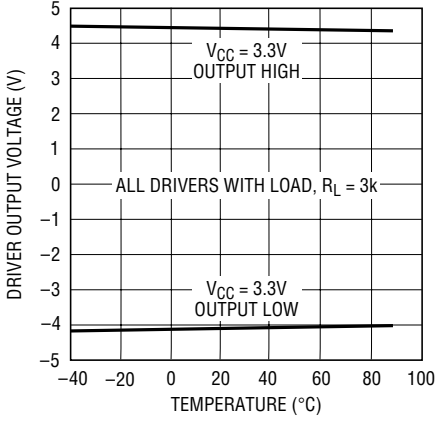

LTC1350 • TPC01

Receiver Input Thresholds vs Temperature

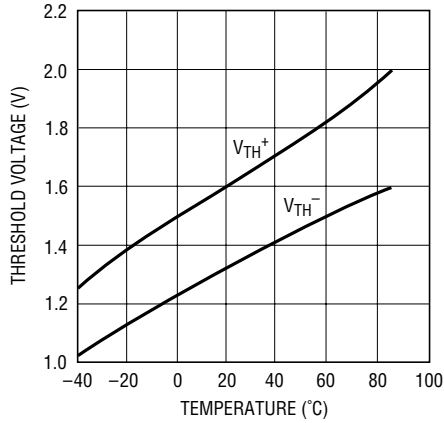

LTC1350 • TPC02

Supply Current vs Data Rate

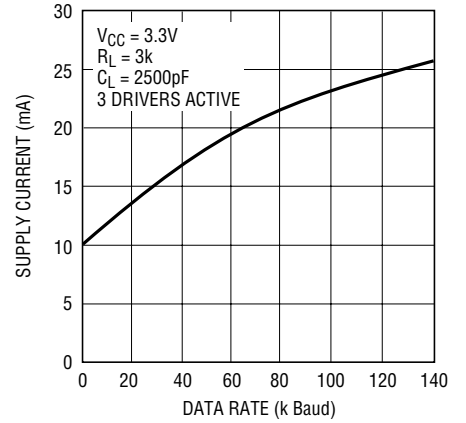

LTC1350 • TPC03

VCC Supply Current vs Temperature

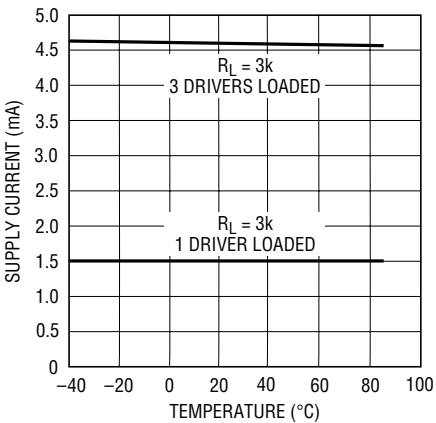

LTC1350 • TPC04

Driver Leakage in Shutdown vs Temperature

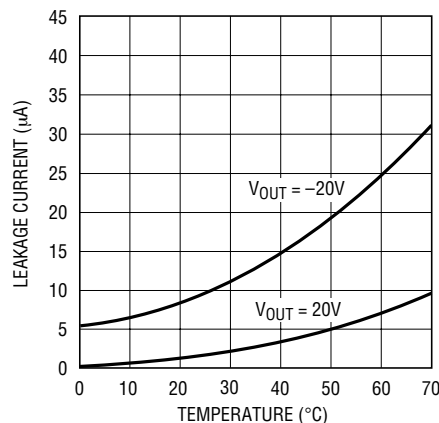

LTC1350 • TPC05

Driver Short-Circuit Current vs Temperature

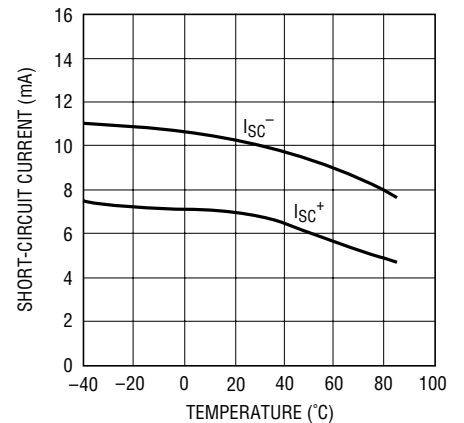

LTC1350 • TPC06

Receiver Short-Circuit Current vs Temperature

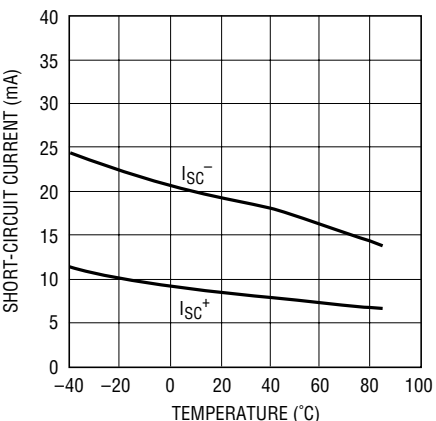

LTC1350 • TPC07

Driver Output Waveforms

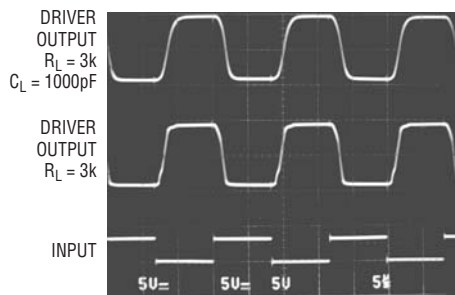

LTC1350 • TPC08

Receiver Output Waveform

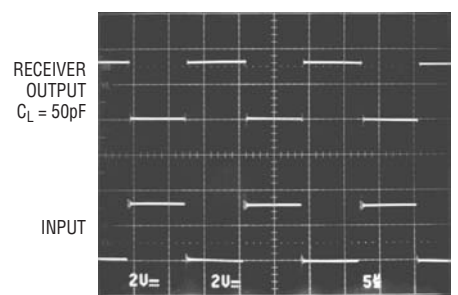

LTC1350 • TPC09

PIN FUNCTIONS

V_{CC}: 3.3V Input Supply Pin. Supply current is typically 35 μ A in the Shutdown mode. This pin should be decoupled with a 0.1 μ F ceramic capacitor.

GND: Ground Pin.

ON/OFF: TTL/CMOS Compatible Shutdown Pin. A logic low puts the device in the Shutdown mode with receivers 4 and 5 kept alive and the supply current equal to 35 μ A. All driver and other receiver outputs are in high impedance state. This pin cannot float.

V⁺: Positive Supply Output. $V^+ \cong 2V_{CC} - 1V$. This pin requires an external capacitor ($C = 0.1\mu F$) for charge storage. The capacitor may be tied to ground or V_{CC} . With multiple devices, the V^+ and V^- pins may be paralleled into common capacitors. For a large number of devices, increasing the size of the shared common storage capacitors is recommended to reduce ripple.

V⁻: Negative Supply Output. $V^- \cong -(2V_{CC} - 1.3V)$. This pin requires an external capacitor ($C = 0.1\mu F$) for charge storage.

C1⁺, C1⁻, C2⁺, C2⁻: Commutating Capacitor Inputs. These pins require two external capacitors ($C = 0.1\mu F$): one from C1⁺ to C1⁻ and another from C2⁺ to C2⁻. To maintain charge pump efficiency, the capacitor's effective series resistance should be less than 20 Ω .

DR IN: EIA/TIA-562 Driver Input Pins. Inputs are TTL/CMOS compatible. Inputs should not be allowed to float. Tie unused inputs to V_{CC} .

DR OUT: Driver Outputs at EIA/TIA-562 Voltage Levels. Outputs are in a high impedance state when in the Shutdown mode or $V_{CC} = 0V$. The driver outputs are protected against ESD to $\pm 10kV$ for human body model discharges.

RX IN: Receiver Inputs. These pins can be forced to $\pm 25V$ without damage. The receiver inputs are protected against ESD to $\pm 10kV$ for human body model discharges. Each receiver provides 0.4V of hysteresis for noise immunity.

RX OUT: Receiver Outputs with TTL/CMOS Voltage Levels. Receiver 1, 2 and 3 outputs are in a high impedance state when in Shutdown mode to allow data line sharing. Receivers 4 and 5 are kept alive in Shutdown.

SWITCHING TIME WAVEFORMS

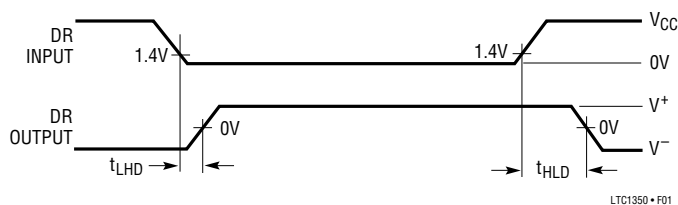

Figure 1. Driver Propagation Delay Timing

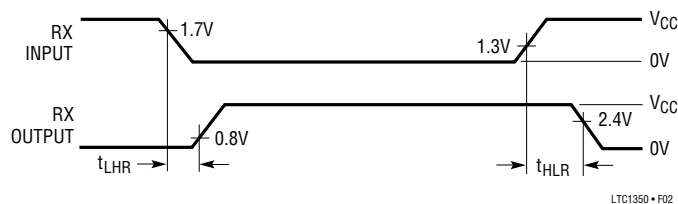
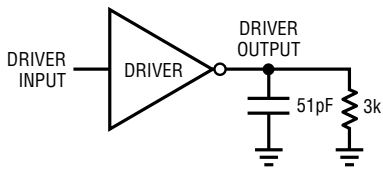

Figure 2. Receiver Propagation Delay Timing

TEST CIRCUITS

Driver Timing Test Load



LTC1350 • TA03

Receiver Timing Test Load

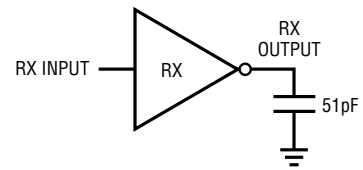

LTC1350 • TA04

ESD Test Circuit

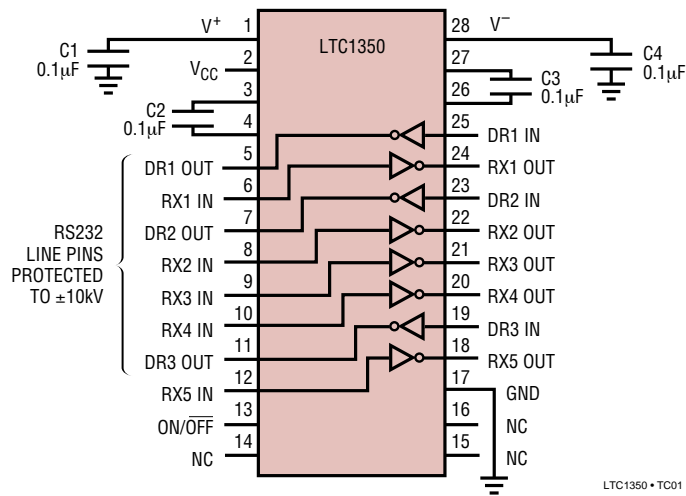

LTC1350 • TC01

PACKAGE DESCRIPTION

G Package 28-Lead Plastic SSOP (5.3mm) (Reference LTC DWG # 05-08-1640)

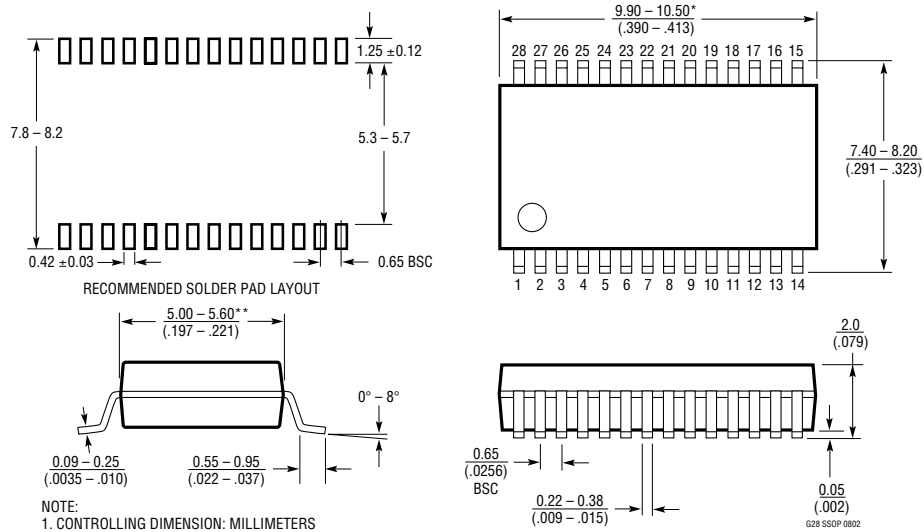

NOTE:
 1. CONTROLLING DIMENSION: MILLIMETERS
 2. DIMENSIONS ARE IN MILLIMETERS (INCHES)
 3. DRAWING NOT TO SCALE
 *DIMENSIONS DO NOT INCLUDE MOLD FLASH. MOLD FLASH SHALL NOT EXCEED .152mm (.006") PER SIDE
 **DIMENSIONS DO NOT INCLUDE INTERLEAD FLASH. INTERLEAD FLASH SHALL NOT EXCEED .254mm (.010") PER SIDE

NW Package 28-Lead PDIP (Wide .600 Inch) (Reference LTC DWG # 05-08-1520)

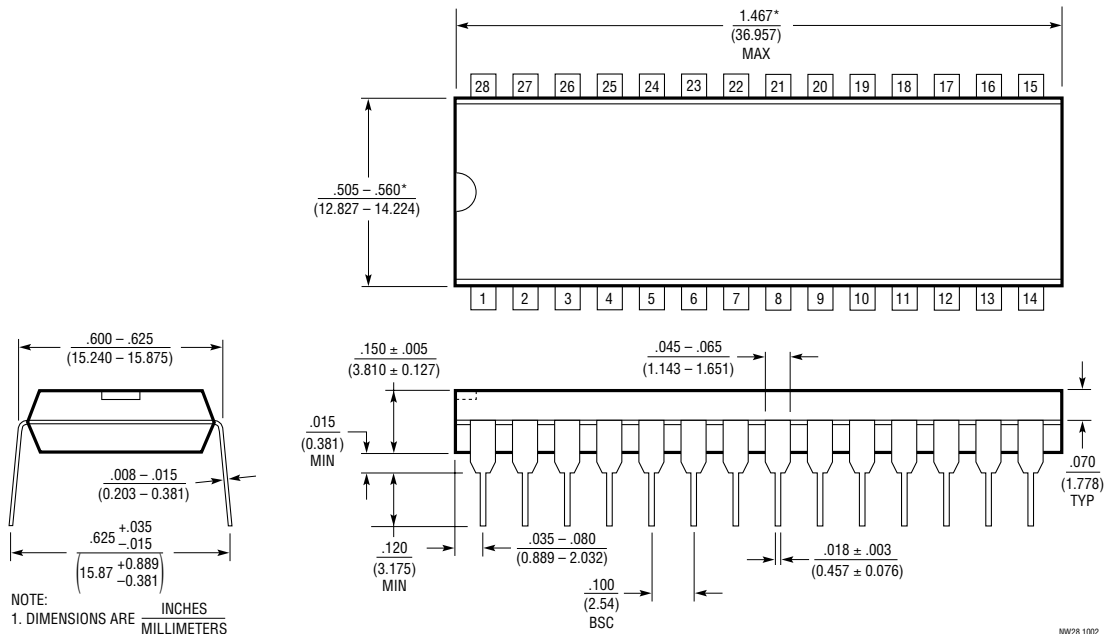

NOTE:
 1. DIMENSIONS ARE INCHES MILLIMETERS
 *THESE DIMENSIONS DO NOT INCLUDE MOLD FLASH OR PROTRUSIONS. MOLD FLASH OR PROTRUSIONS SHALL NOT EXCEED .010 INCH (0.254mm)

NW28 1002