

FEATURES

- Operates from a Single 3.3V Supply
- Low Supply Current: $I_{CC} = 200\mu\text{A}$
- $I_{CC} = 35\mu\text{A}$ in Driver Disable Mode
- $I_{CC} = 0.2\mu\text{A}$ in Shutdown Mode
- ESD Protection Over $\pm 10\text{kV}$
- Uses Small Capacitors: $0.1\mu\text{F}$
- Operates to 120kbaud
- Output Overvoltage Does Not Force Current Back into Supplies
- EIA/TIA-562 I/O Lines Can Be Forced to $\pm 25\text{V}$ Without Damage
- Pin Compatible with LT1180A

APPLICATIONS

- Notebook Computers
- Palmtop Computers

DESCRIPTION

The LTC[®]1385 is an ultra-low power, 2-driver/2-receiver EIA/TIA-562 transceiver which operates from a single 3.3V supply. The charge pump requires only four space-saving $0.1\mu\text{F}$ capacitors.

The transceiver operates in one of three modes: Normal, Driver Disable or Shutdown. In the Normal mode, I_{CC} is only $200\mu\text{A}$ in the unloaded condition. In the Driver Disable mode, the charge pump is turned off, the driver outputs are forced into three-state, both receivers are kept active, and I_{CC} drops to $35\mu\text{A}$. In the Shutdown mode, everything is turned off and I_{CC} drops to $0.2\mu\text{A}$.

The LTC1385 is fully compliant with all data rate and overvoltage EIA/TIA-562 specifications. The transceiver can operate up to 120kbaud with a 1000pF , $3\text{k}\Omega$ load. Both driver outputs and receiver inputs can be forced to $\pm 25\text{V}$ without damage, and can survive multiple $\pm 10\text{kV}$ ESD strikes.

 LTC and LT are registered trademarks of Linear Technology Corporation.

TYPICAL APPLICATION

2-Drivers/2-Receivers with Shutdown and Driver Disable

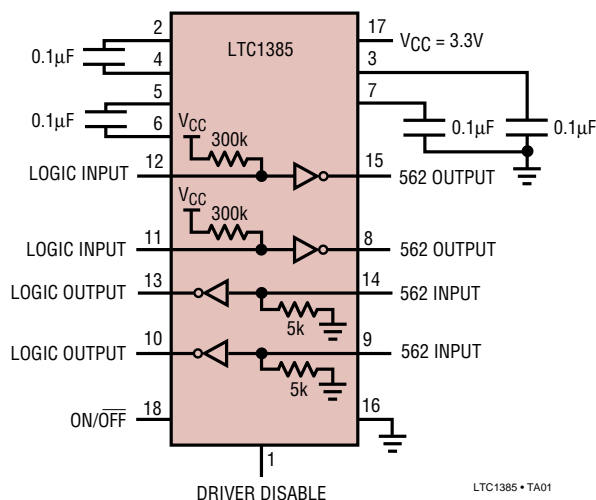

Quiescent and Shutdown Supply Current vs Temperature

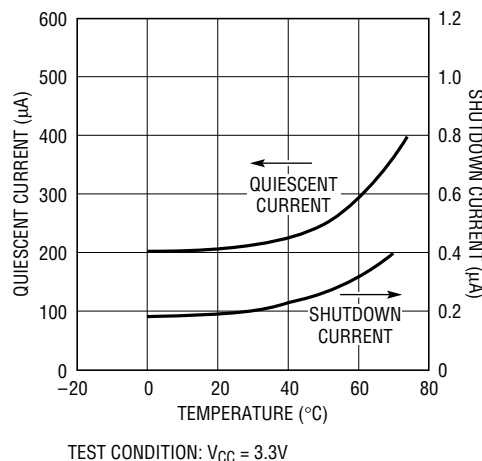

ABSOLUTE MAXIMUM RATINGS

Supply Voltage (V_{CC})	5V	Short-Circuit Duration	
Input Voltage		V^+	30 sec
Driver	-0.3V to $V_{CC} + 0.3V$	V^-	30 sec
Receiver	-25V to 25V	Driver Output	Indefinite
Digital Input	-0.3V to $V_{CC} + 0.3V$	Receiver Output	Indefinite
Output Voltage		Operating Temperature Range	
Driver	-25V to 25V	LTC1385C	0°C to 70°C
Receiver	-0.3V to $V_{CC} + 0.3V$	LTC1385I	-40°C to 85°C
		Storage Temperature Range	-65°C to 150°C
		Lead Temperature (Soldering, 10 sec)	300°C

PACKAGE/ORDER INFORMATION

<p>G PACKAGE 20-LEAD SSOP</p> <p>$T_{JMAX} = 125^{\circ}C, \theta_{JA} = 135^{\circ}C/W$</p>	<p>ORDER PART NUMBER</p> <p>LTC1385CG LTC1385IG</p>	<p>N PACKAGE 18-LEAD PDIP</p> <p>SW PACKAGE 18-LEAD PLASTIC SO</p> <p>$T_{JMAX} = 125^{\circ}C, \theta_{JA} = 85^{\circ}C/W$</p>	<p>ORDER PART NUMBER</p> <p>LTC1385CN LTC1385CSW LTC1385IN LTC1385ISW</p>
---	---	---	---

Consult LTC Marketing for parts specified with wider operating temperature ranges.

DC ELECTRICAL CHARACTERISTICS

The ● denotes specifications which apply over the full operating temperature range. $V_{CC} = 3.3V$, $C1 = C2 = C3 = C4 = 0.1\mu F$, $V_{ON/OFF} = V_{CC}$, Driver Disable = V_{CC} , unless noted.

PARAMETER	CONDITIONS	MIN	TYP	MAX	UNITS
Any Driver					
Output Voltage Swing	3k to GND	Positive Negative	3.7 -3.7	4.5 -4.5	V V
Logic Input Voltage Level	Input Low Level ($V_{OUT} = \text{High}$) Input High Level ($V_{OUT} = \text{Low}$)		2.0	1.4 1.4	0.8 V
Logic Input Current	$V_{IN} = V_{CC}$ $V_{IN} = 0V$			-20 -40	μA μA
Output Short-Circuit Current	$V_{OUT} = 0V$		± 10		mA
Output Leakage Current	Shutdown or Driver Disable or $V_{CC} = 0V$ (Note 3,4), $V_{OUT} = \pm 20V$		± 10	± 500	μA

DC ELECTRICAL CHARACTERISTICS

The ● denotes specifications which apply over the full operating temperature range. $V_{CC} = 3.3V$, $C1 = C2 = C3 = C4 = 0.1\mu F$, $V_{ON/OFF} = V_{CC}$, Driver Disable = V_{CC} , unless noted.

PARAMETER	CONDITIONS		MIN	TYP	MAX	UNITS
Any Receiver						
Input Voltage Thresholds	Input Low Threshold	●	0.8	1.3		V
	Input High Threshold	●		1.7	2.4	V
Hysteresis		●	0.1	0.4	1.0	V
Input Resistance	$-10V \leq V_{IN} \leq 10V$		3	5	7	k Ω
Output Voltage	Output Low, $I_{OUT} = -1.6mA$ ($V_{CC} = 3.3V$)	●		0.2	0.4	V
	Output High, $I_{OUT} = 160\mu A$ ($V_{CC} = 3.3V$)	●	3.0	3.2		V
Output Short-Circuit Current	Sinking Current, $V_{OUT} = V_{CC}$		-5	-20		mA
	Sourcing Current, $V_{OUT} = 0V$		2	7		mA
Output Leakage Current	Shutdown (Note 4), $0V \leq V_{OUT} \leq V_{CC}$	●		1	10	μA
Power Supply Generator						
V^+ Output Voltage	$I_{OUT} = 0mA$			5.7		V
	$I_{OUT} = 5mA$			5.5		V
V^- Output Voltage	$I_{OUT} = 0mA$			-5.3		V
	$I_{OUT} = -5mA$			-5.0		V
Supply Rise Time	Shutdown or Driver Disable to Turn-On			0.2		ms
Power Supply						
V_{CC} Supply Current	No Load (Note 2), $0^\circ C$ to $70^\circ C$	●		0.2	0.5	mA
	No Load (Note 2), $-40^\circ C$ to $85^\circ C$	●		3.5	1.0	mA
Supply Leakage Current (V_{CC})	Shutdown (Note 4)	●		0.2	10	μA
	Driver Disable (Note 3)	●		35	50	μA
Digital Input Threshold Low		●		1.4	0.8	V
Digital Input Threshold High		●	2.0	1.4		V

AC CHARACTERISTICS

The ● denotes specifications which apply over the full operating temperature range. $V_{CC} = 3.3V$, $C1 = C2 = C3 = C4 = 0.1\mu F$, unless noted.

PARAMETER	CONDITIONS		MIN	TYP	MAX	UNITS
Slew Rate	$R_L = 3k, C_L = 51pF$			8	30	V/ μs
	$R_L = 3k, C_L = 1000pF$		3	5		V/ μs
Driver Propagation Delay (TTL to EIA/TIA-562)	t_{HLD} (Figure 1)	●		2	3.5	μs
	t_{LHD} (Figure 1)	●		2	3.5	μs
Receiver Propagation Delay (EIA/TIA-562 to TTL)	t_{HLR} (Figure 2)	●		0.3	0.8	μs
	t_{LHR} (Figure 2)	●		0.2	0.8	μs

Note 1: Absolute Maximum Ratings are those values beyond which the life of the device may be impaired.

Note 2: Supply current is measured with driver and receiver outputs unloaded.

Note 3: Measurements made in the Driver Disable mode are performed with $V_{DRIVER\ DISABLE} = GND$ and $V_{ON/OFF} = V_{CC}$.

Note 4: Measurements made in the Shutdown mode are performed with $V_{ON/OFF} = 0V$.

TYPICAL PERFORMANCE CHARACTERISTICS

Driver Output Voltage vs Temperature

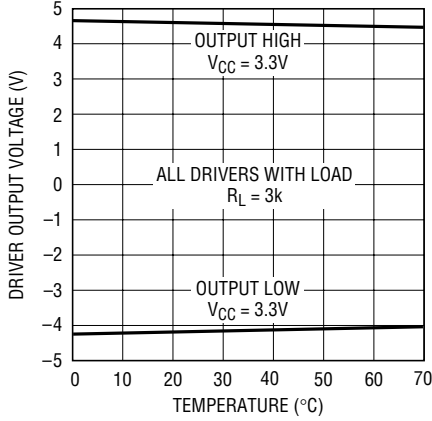

LTC1385 • TPC01

Receiver Input Thresholds vs Temperature

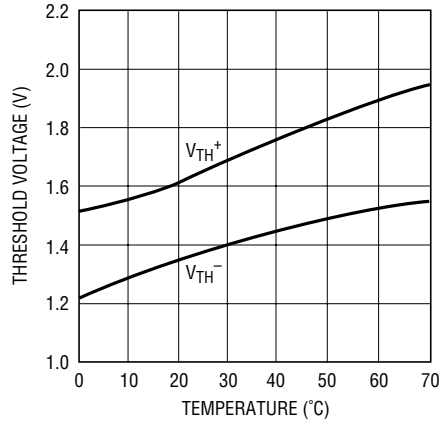

LTC1385 • TPC02

Supply Current vs Data Rate

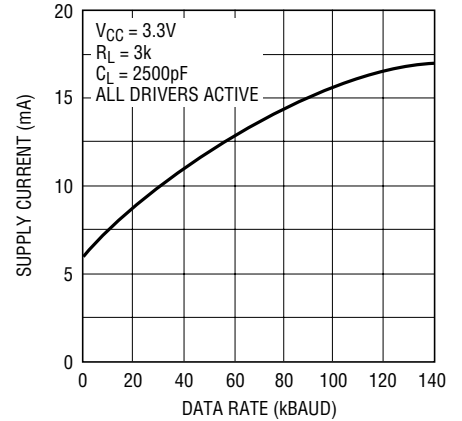

LTC1385 • TPC03

VCC Supply Current vs Temperature

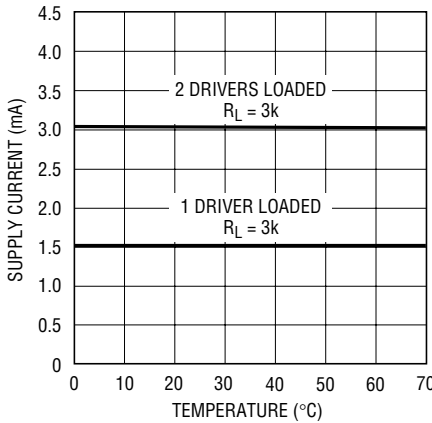

LTC1385 • TPC04

Driver Leakage in Shutdown vs Temperature

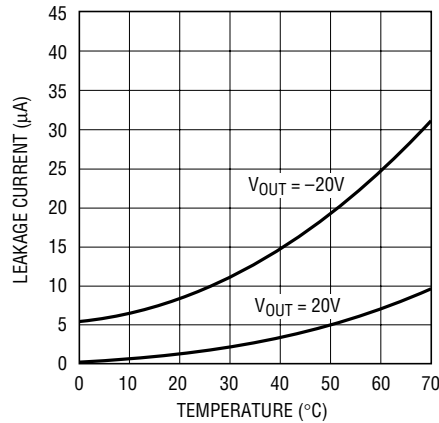

LTC1385 • TPC05

Driver Short-Circuit Current vs Temperature

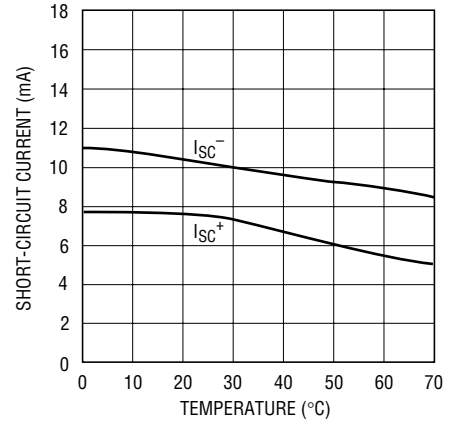

LTC1385 • TPC06

Receiver Short-Circuit Current vs Temperature

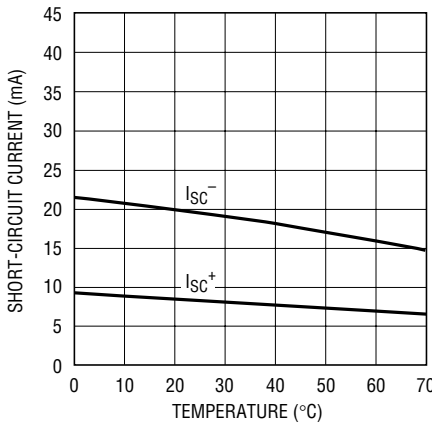

LTC1385 • TPC06

Driver Output Waveforms

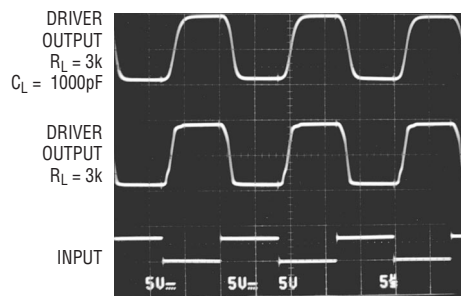

LTC1385 • TPC08

Receiver Output Waveform

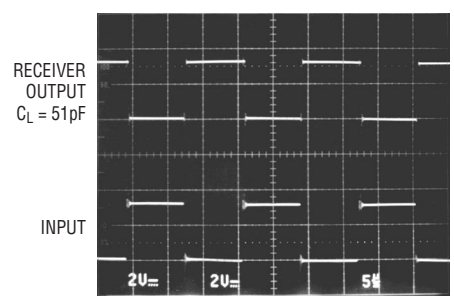

LTC1385 • TPC09

PIN FUNCTIONS

V_{CC}: 3.3V Input Supply Pin. This pin should be decoupled with a 0.1μF ceramic capacitor.

GND: Ground Pin.

ON/OFF: TTL/CMOS Compatible Shutdown Pin. A logic low puts the device in the Shutdown mode independent of the Driver Disable pin. The supply current drops to 0.2μA and all driver and receiver outputs are forced into three-state.

DRIVER DISABLE: TTL/CMOS Compatible Input Pin. With the ON/OFF pin held high, a logic low forces the part into the Driver Disable mode with the charge pump turned off and the driver outputs forced into three-state. Both receivers remain active and the supply current drops to 35μA. A logic high forces the part into the Normal mode.

V⁺: Positive Supply Output (EIA/TIA-562 Drivers). $V^+ \cong 2V_{CC} - 1V$. This pin requires an external capacitor $C = 0.1\mu F$ for charge storage. The capacitor may be tied to ground or V_{CC} . With multiple devices, the V^+ and V^- pins may share a common capacitor. For a large number of devices, increasing the size of the shared common storage capacitors is recommended to reduce ripple.

V⁻: Negative Supply Output (EIA/TIA-562 Drivers). $V^- \cong -(2V_{CC} - 1.3V)$. This pin requires an external capacitor $C = 0.1\mu F$ for charge storage.

C1⁺, C1⁻, C2⁺, C2⁻: Commutating Capacitor Inputs. These pins require two external capacitors $C = 0.1\mu F$: one from C1⁺ to C1⁻, and another from C2⁺ to C2⁻. To maintain charge pump efficiency, the capacitor's effective series resistance should be less than 2Ω.

TR IN: EIA/TIA-562 Driver Input Pins. Inputs are TTL/CMOS compatible. The inputs of unused drivers can be left unconnected since 300k input pull-up resistors to V_{CC} are included on chip. To minimize power consumption, the internal driver pull-up resistors are disconnected from V_{CC} in the Shutdown mode.

TR OUT: Driver Outputs at EIA/TIA-562 Voltage Levels. Outputs are in a high impedance state when in the Shutdown or Driver Disable mode or $V_{CC} = 0V$. The driver outputs are protected against ESD to ±10kV for human body model discharges.

RX IN: Receiver Inputs. These pins can be forced to ±25V without damage. The receiver inputs are protected against ESD to ±10kV for human body model discharges. Each receiver provides 0.4V of hysteresis for noise immunity.

RX OUT: Receiver Outputs with TTL/CMOS Voltage Levels. Outputs are in a high impedance state when in the Shutdown mode.

SWITCHING TIME WAVEFORMS

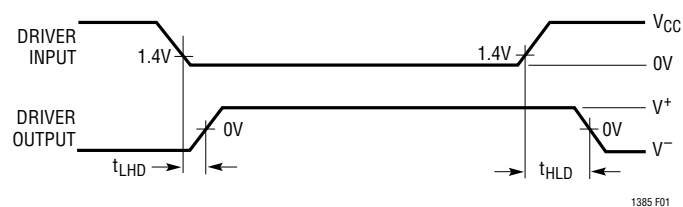

Figure 1. Driver Propagation Delay Timing

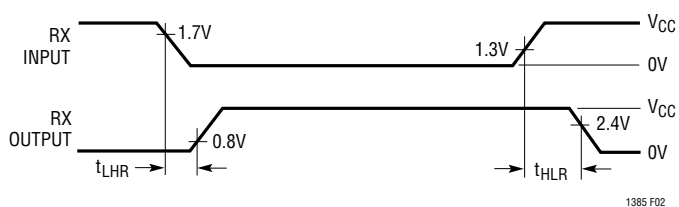
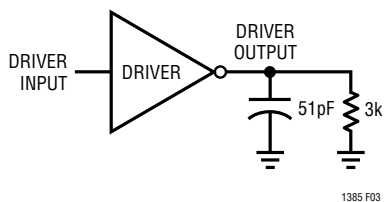

Figure 2. Receiver Propagation Delay Timing

TEST CIRCUITS

Driver Timing Test Load



1385 F03

Receiver Timing Test Load

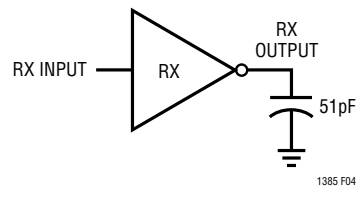

1385 F04

ESD Test Circuit



1385 F05

PACKAGE DESCRIPTION

G Package 20-Lead Plastic SSOP (5.3mm) (Reference LTC DWG # 05-08-1640)

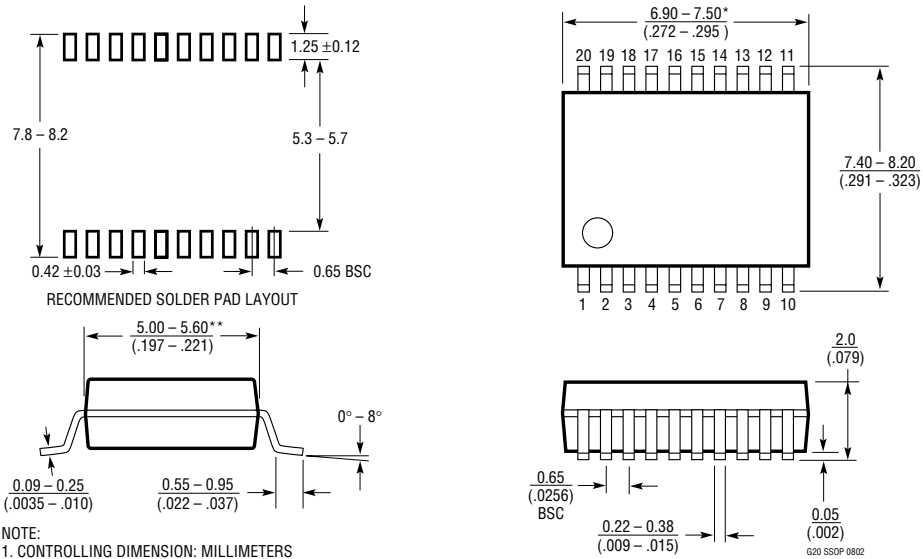

- NOTE:
1. CONTROLLING DIMENSION: MILLIMETERS
 2. DIMENSIONS ARE IN $\frac{\text{MILLIMETERS}}{\text{INCHES}}$
 3. DRAWING NOT TO SCALE
- *DIMENSIONS DO NOT INCLUDE MOLD FLASH. MOLD FLASH SHALL NOT EXCEED .152mm (.006") PER SIDE
- **DIMENSIONS DO NOT INCLUDE INTERLEAD FLASH. INTERLEAD FLASH SHALL NOT EXCEED .254mm (.010") PER SIDE

N Package 18-Lead PDIP (Narrow .300 Inch) (Reference LTC DWG # 05-08-1510)

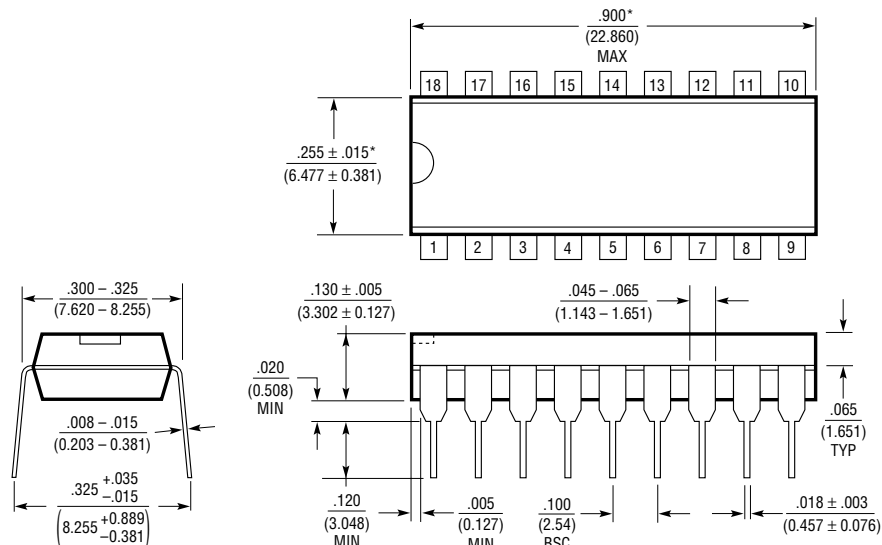

- NOTE:
1. DIMENSIONS ARE $\frac{\text{INCHES}}{\text{MILLIMETERS}}$
- *THESE DIMENSIONS DO NOT INCLUDE MOLD FLASH OR PROTRUSIONS. MOLD FLASH OR PROTRUSIONS SHALL NOT EXCEED .010 INCH (0.254mm)

W18 1002