

FEATURES

- Operates from a Single 3.3V Supply
- Low Supply Current: $I_{CC} = 200\mu\text{A}$
- ESD Protection Over $\pm 10\text{kV}$
- Available in 16-Pin SOIC Narrow Package
- Uses Small Capacitors: $0.1\mu\text{F}$
- Operates to 120kbaud
- Output Overvoltage Does Not Force Current Back into Supplies
- EIA/TIA562 I/O Lines Can Be Forced to $\pm 25\text{V}$ Without Damage
- Pin Compatible with LT1181A

APPLICATIONS

- Notebook Computers
- Palmtop Computers

DESCRIPTION

The LTC[®]1386 is an ultra-low power 2-driver/2-receiver EIA/TIA562 transceiver that operates from a single 3.3V supply. The charge pump requires only four space-saving $0.1\mu\text{F}$ capacitors. The supply current (I_{CC}) of the transceiver is only $200\mu\text{A}$ with driver outputs unloaded.

The LTC1386 is fully compliant with all data rate and overvoltage EIA/TIA562 specifications. The transceiver can operate up to 120kbaud with a 1000pF , $3\text{k}\Omega$ load. Both driver outputs and receiver inputs can be forced to $\pm 25\text{V}$ without damage and can survive multiple $\pm 10\text{kV}$ ESD strikes.

 LTC and LT are registered trademarks of Linear Technology Corporation.

TYPICAL APPLICATION

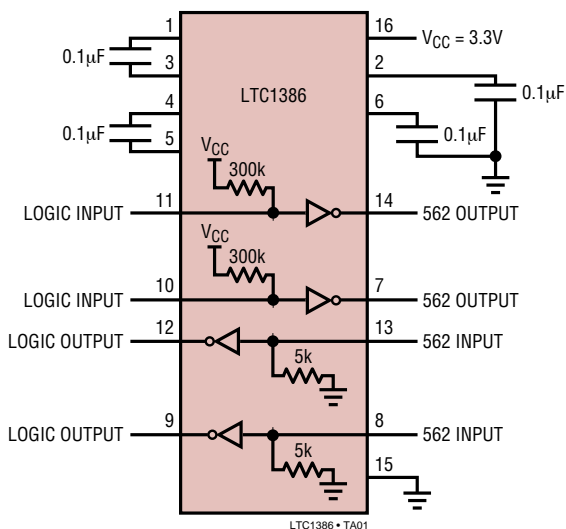

Quiescent Supply Current vs Temperature

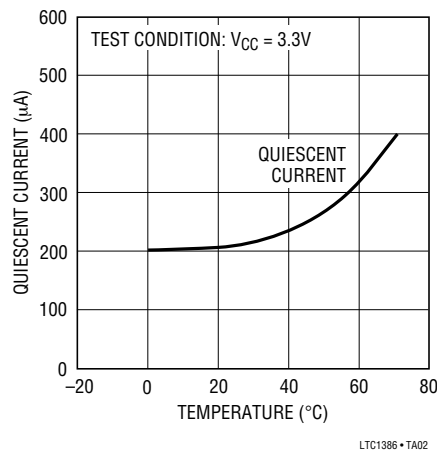

ABSOLUTE MAXIMUM RATINGS

Supply Voltage (V_{CC})	5V
Input Voltage	
Driver	-0.3V to $V_{CC} + 0.3V$
Receiver	-25V to 25V
Digital Input	-0.3V to $V_{CC} + 0.3V$
Output Voltage	
Driver	-25V to 25V
Receiver	-0.3V to $V_{CC} + 0.3V$
Short-Circuit Duration	
V^+	30 sec
V^-	30 sec
Driver Output	Indefinite
Receiver Output	Indefinite
Operating Temperature Range	
LTC1386C	0°C to 70°C
LTC1386I	-40°C to 85°C
Storage Temperature Range	-65°C to 150°C
Lead Temperature (Soldering, 10 sec)	300°C

PACKAGE/ORDER INFORMATION

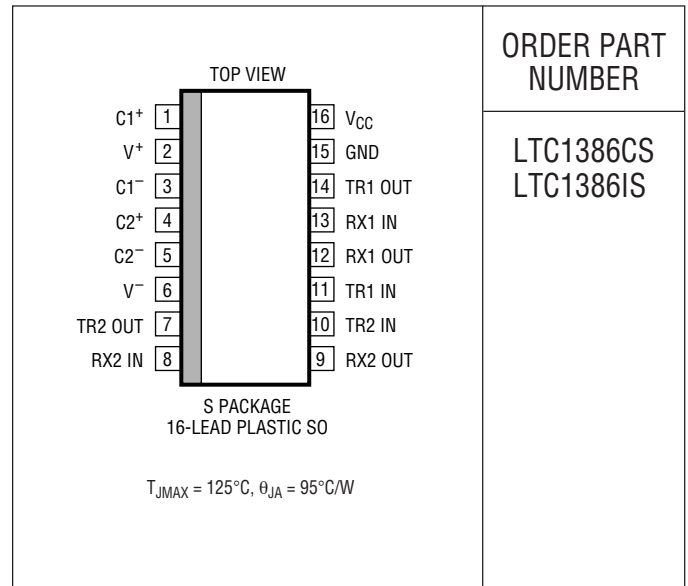

ORDER PART NUMBER

LTC1386CS
LTC1386IS

Consult LTC Marketing for parts specified with wider operating temperature ranges.

DC ELECTRICAL CHARACTERISTICS

The ● denotes specifications which apply over the full operating temperature range. $V_{CC} = 3.3V$, $C1 = C2 = C3 = C4 = 0.1\mu F$, unless otherwise noted.

PARAMETER	CONDITIONS	MIN	TYP	MAX	UNITS
Any Driver					
Output Voltage Swing	3k to GND Positive Negative	● ●	3.7 -3.7	4.5 -4.5	V V
Logic Input Voltage Level	Input Low Level ($V_{OUT} = \text{High}$) Input High Level ($V_{OUT} = \text{Low}$)	● ●	2.0	1.4 1.4	0.8 V V
Logic Input Current	$V_{IN} = V_{CC}$ $V_{IN} = 0V$	● ●		-20	5 μA μA
Output Short-Circuit Current	$V_{OUT} = 0V$		±9	±10	mA
Any Receiver					
Input Voltage Thresholds	Input Low Threshold Input High Threshold	● ●	0.8	1.3 1.7	2.4 V V
Hysteresis		●	0.1	0.4	1 V
Input Resistance	$-10V \leq V_{IN} \leq 10V$		3	5	7 kΩ
Output Voltage	Output Low, $I_{OUT} = -1.6mA$ ($V_{CC} = 3.3V$) Output High, $I_{OUT} = 160\mu A$ ($V_{CC} = 3.3V$)	● ●		0.2 3.0	0.4 V V
Output Short-Circuit Current	Sinking Current, $V_{OUT} = V_{CC}$ Sourcing Current, $V_{OUT} = GND$		-5	-20	7 mA mA
Power Supply Generator					
V^+ Output Voltage	$I_{OUT} = 0mA$ $I_{OUT} = 5mA$			5.7 5.5	V V
V^- Output Voltage	$I_{OUT} = 0mA$ $I_{OUT} = -5mA$			-5.3 -5.0	V V
Power Supply					
V_{CC} Supply Current	No Load (Note 2), 0°C to 70°C No Load (Note 2), -40°C to 85°C	● ●		0.2 0.35	0.5 1.0 mA mA

1386fa

AC CHARACTERISTICS The ● denotes specifications which apply over the full operating temperature range.
 $V_{CC} = 3.3V$, $C_1 = C_2 = C_3 = C_4 = 0.1\mu F$, unless otherwise noted.

PARAMETER	CONDITIONS	MIN	TYP	MAX	UNITS
Slew Rate	$R_L = 3k$, $C_L = 51pF$		8	30	$V/\mu S$
	$R_L = 3k$, $C_L = 1000pF$	3	5		$V/\mu S$
Driver Propagation Delay (TTL to EIA/TIA562)	t_{HLD} (Figure 1)	●	2	3.5	μS
	t_{LHD} (Figure 1)	●	2	3.5	μS
Receiver Propagation Delay (EIA/TIA562 to TTL)	t_{HLR} (Figure 2)	●	0.3	0.8	μS
	t_{LHR} (Figure 2)	●	0.3	0.8	μS

Note 1: Absolute Maximum Ratings are those values beyond which the life of the device may be impaired.

Note 3: Measurements made in the shutdown mode are performed with $V_{ON/OFF} = 0V$.

Note 2: Supply current is measured with driver and receiver outputs unloaded.

TYPICAL PERFORMANCE CHARACTERISTICS

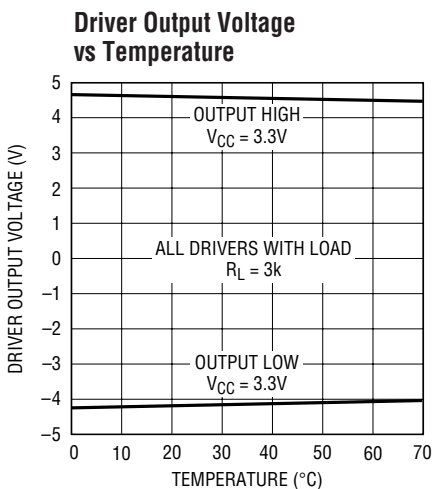

LTC1386 • TPC01

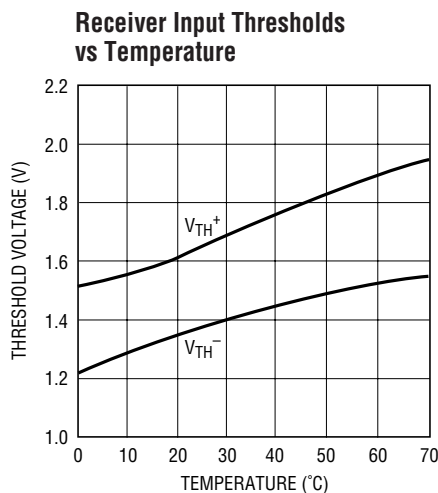

LTC1386 • TPC02

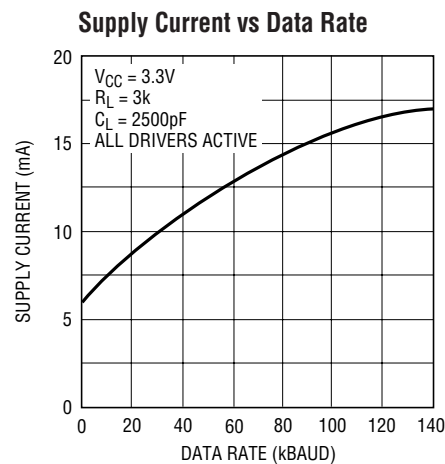

LTC1386 • TPC03

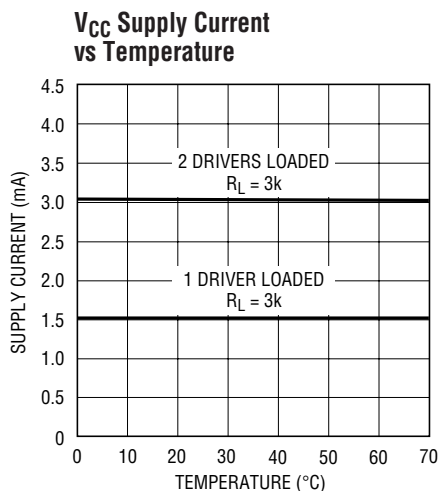

LTC1386 • TPC04

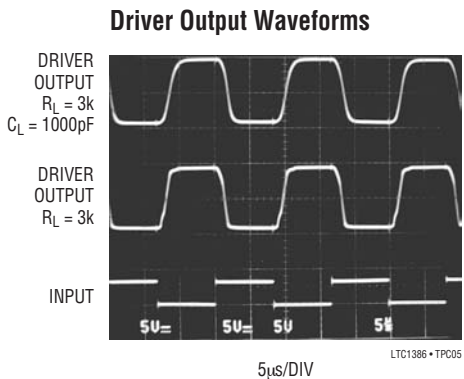

LTC1386 • TPC05

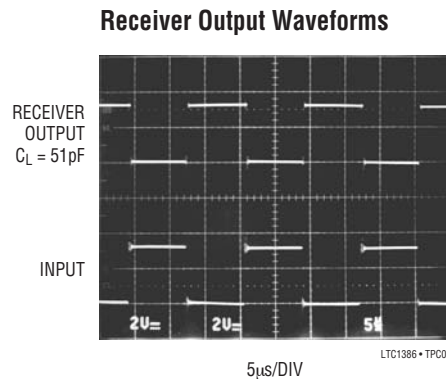

LTC1386 • TPC06

PIN FUNCTIONS

V_{CC}: 3.3V Input Supply Pin. This pin should be decoupled with a 0.1 μ F ceramic capacitor.

GND: Ground Pin.

V⁺: Positive Supply Output (EIA/TIA562 Drivers). $V^+ \cong 2V_{CC} - 1V$. This pin requires an external capacitor $C = 0.1\mu F$ for charge storage. The capacitor may be tied to ground or V_{CC} . With multiple devices, the V^+ and V^- pins may share a common capacitor. For large numbers of devices, increasing the size of the shared common storage capacitors is recommended to reduce ripple.

V⁻: Negative Supply Output (RS232 Drivers). $V^- \cong -(2V_{CC} - 1.3V)$. This pin requires an external capacitor $C = 0.1\mu F$ for charge storage.

C1⁺, C1⁻, C2⁺, C2⁻: Commutating Capacitor Inputs. These pins require two external capacitors $C = 0.1\mu F$: one from C1⁺ to C1⁻ and another from C2⁺ to C2⁻. To maintain

charge pump efficiency, the capacitor's effective series resistance should be less than 2 Ω .

TR IN: EIA/TIA562 Driver Input Pins. Inputs are TTL/CMOS compatible. The inputs of unused drivers can be left unconnected since 300k input pull-up resistors to V_{CC} are included on chip.

TR OUT: Driver Outputs at EIA/TIA562 Voltage Levels. The driver outputs are protected against ESD to $\pm 10kV$ for human body model discharges.

RX IN: Receiver Inputs. These pins can be forced to $\pm 25V$ without damage. The receiver inputs are protected against ESD to $\pm 10kV$ for human body model discharges. Each receiver provides 0.4V of hysteresis for noise immunity.

RX OUT: Receiver Outputs with TTL/CMOS Voltage Levels.

SWITCHING TIME WAVEFORMS

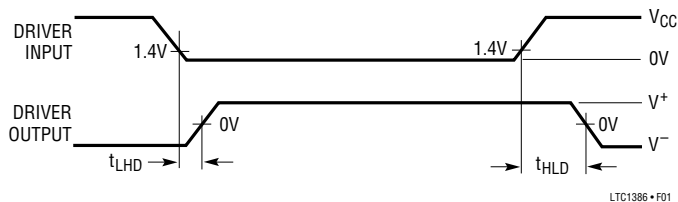

Figure 1. Driver Propagation Delay Timing

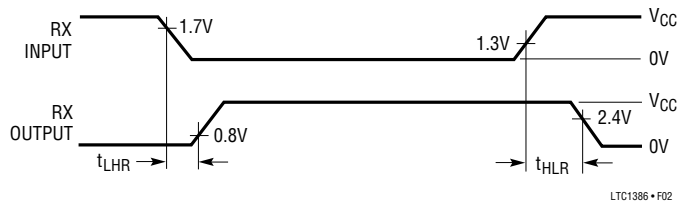
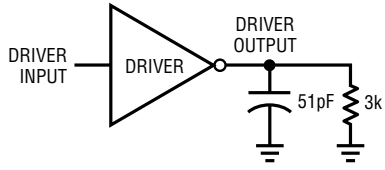

Figure 2. Receiver Propagation Delay Timing

TEST CIRCUITS

Driver Timing Test Load



LTC1386 • TA03

Receiver Timing Test Load

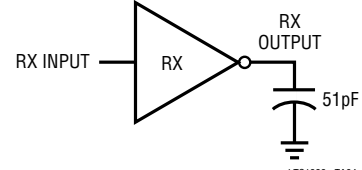

LTC1386 • TA04

ESD Test Circuit

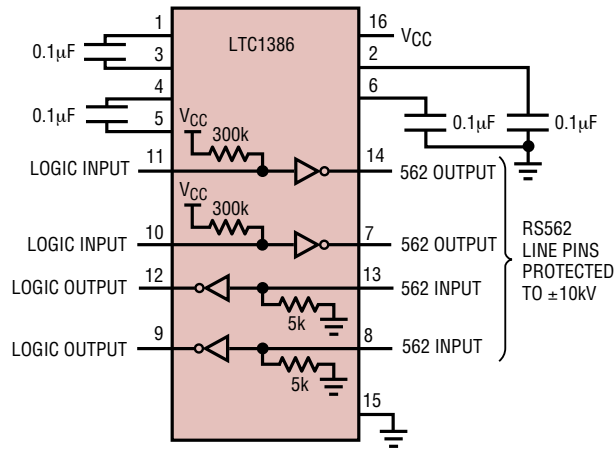

1386 TA05

PACKAGE DESCRIPTION

S Package 16-Lead Plastic Small Outline (Narrow .150 Inch) (Reference LTC DWG # 05-08-1610)

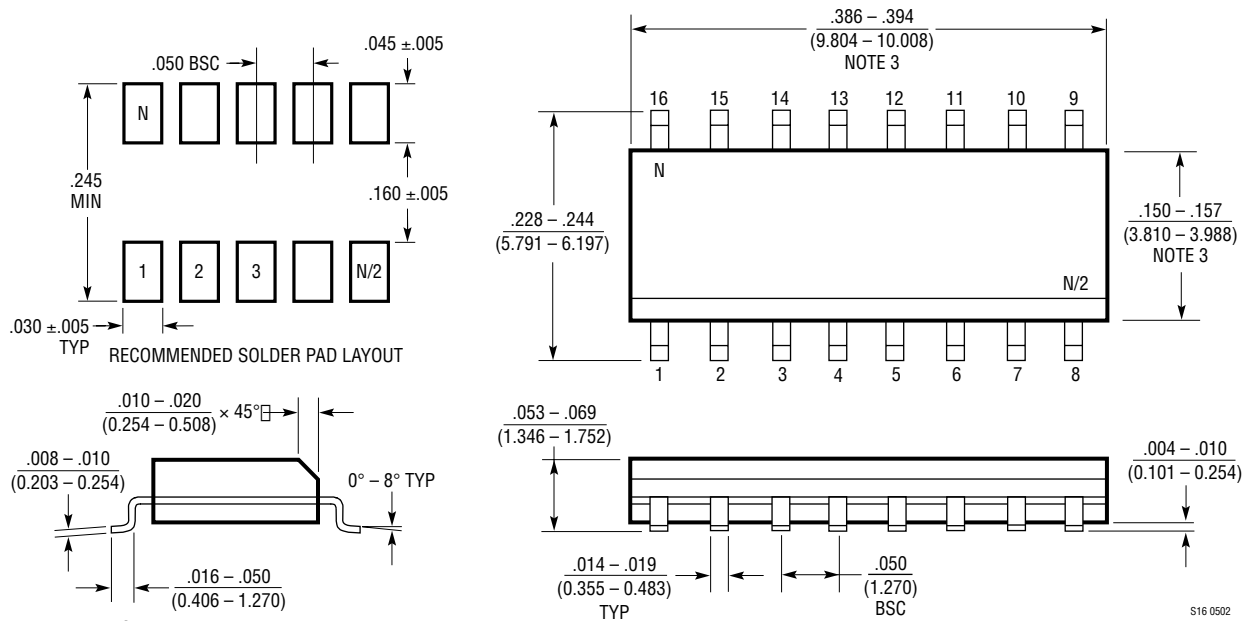

- NOTE:
1. DIMENSIONS IN $\frac{\text{INCHES}}{\text{MILLIMETERS}}$
 2. DRAWING NOT TO SCALE
 3. THESE DIMENSIONS DO NOT INCLUDE MOLD FLASH OR PROTRUSIONS. MOLD FLASH OR PROTRUSIONS SHALL NOT EXCEED $.006''$ (0.15mm)

S16 0502