

Micropower Temperature, Power Supply and Differential Voltage Monitor

FEATURES

- Complete Ambient Temperature Sensor Onboard
- System Power Supply Monitor
- 10-Bit Resolution Rail-to-Rail Common-Mode Differential Voltage Input
- Available in 8-Pin SO and PDIP
- 0.2 μ A Supply Current When Idle
- 700 μ A Supply Current When Sampling at Maximum Rate
- Single Supply Voltage: 4.5V to 6V
- 3-Wire Half-Duplex Serial I/O
- Communicates with Most MPU Serial Ports and All MPU Parallel I/O Ports

APPLICATIONS

- Temperature Measurement
- Power Supply Measurement
- Current Measurement
- Remote Data Acquisition
- Environment Monitoring

 LTC and LT are registered trademarks of Linear Technology Corporation.

DESCRIPTION

The LTC[®]1392 is a micropower data acquisition system designed to measure temperature, on-chip supply voltage and a differential voltage. The differential inputs feature rail-to-rail common mode input voltage range. The LTC1392 contains a temperature sensor, a 10-bit A/D converter with sample-and-hold, a high accuracy bandgap reference and a 3-wire half-duplex serial interface.

The LTC1392 can be programmed to measure ambient temperature, power supply voltage and an external voltage at the differential input pins, that can also be used for current measurement using an external sense resistor. When measuring temperature, the output code of the A/D converter is linearly proportional to the temperature in $^{\circ}$ C. Production trimming achieves $\pm 2^{\circ}$ C initial accuracy at room temperature and $\pm 4^{\circ}$ C over the full -40° C to 85° C temperature range.

The on-chip serial port allows efficient data transfer to a wide range of MPUs over three or four wires. This, coupled with low power consumption, makes remote location sensing possible and facilitates transmitting data through isolation barriers.

TYPICAL APPLICATION

Complete Temperature, Supply Voltage and
Supply Current Monitor

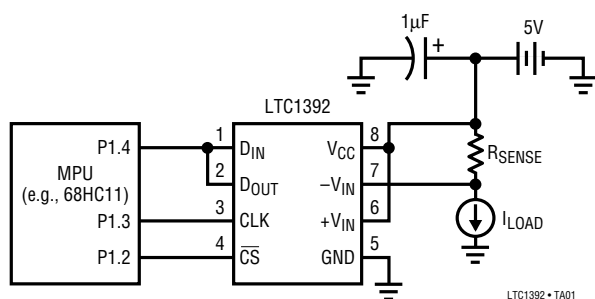

Output Temperature Error

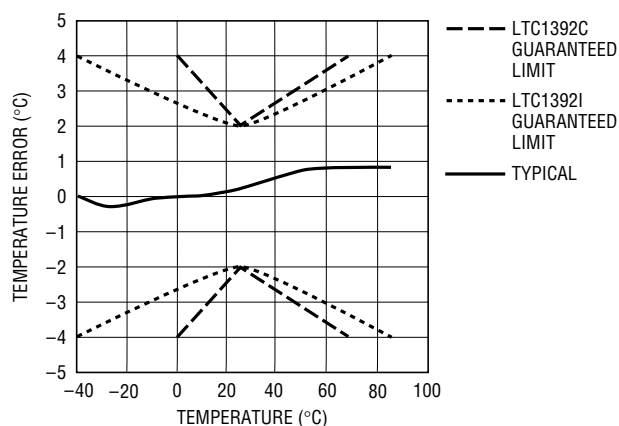

LTC1392 • TA02

ABSOLUTE MAXIMUM RATINGS

(Note 1)

Supply Voltage (V_{CC})	7V
Input Voltage	-0.3V to $V_{CC} + 0.3V$
Output Voltage	-0.3V to $V_{CC} + 0.3V$
Operating Temperature Range	
LTC1392C	0°C to 70°C
LTC1392I	-40°C to 85°C
Junction Temperature	125°C
Storage Temperature Range	-65°C to 150°C
Lead Temperature (Soldering, 10 sec)	300°C

PACKAGE/ORDER INFORMATION

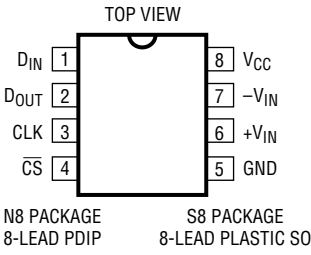
<p style="text-align: center;">TOP VIEW</p>  <p>N8 PACKAGE 8-LEAD PDIP S8 PACKAGE 8-LEAD PLASTIC SO</p> <p>$T_{JMAX} = 125^{\circ}C, \theta_{JA} = 100^{\circ}C/W$ (N8) $T_{JMAX} = 125^{\circ}C, \theta_{JA} = 130^{\circ}C/W$ (S8)</p>	ORDER PART NUMBER
	LTC1392CN8 LTC1392CS8 LTC1392IN8 LTC1392IS8
	S8 PART MARKING
	1392 1392I

Consult factory for Military grade parts.

ELECTRICAL CHARACTERISTICS (Note 2, 3)

PARAMETER	CONDITIONS	MIN	TYP	MAX	UNITS
Power Supply To Digital Conversion					
Resolution	$V_{CC} = 4.5V$ to 6V			10	Bit
Total Absolute Error	$V_{CC} = 4.5V$ to 6V	●		±8	LSB
Differential Voltage to Digital Conversion (Full-Scale Input = 1V)					
Resolution				10	Bit
Integral Linearity Error (Note 5)		●	±0.5	±1	LSB
Differential Linearity Error		●	±0.5	±1	LSB
Offset Error		●		±4	LSB
Full-Scale Error		●		±15	LSB
Differential Voltage to Digital Conversion (Full-Scale Input = 0.5V)					
Resolution				10	Bit
Integral Linearity Error (Note 5)		●	±0.5	±2	LSB
Differential Linearity Error		●	±0.5	±1	LSB
Offset Error		●		±8	LSB
Full-Scale Error		●		±25	LSB
Temperature to Digital Conversion					
Accuracy	$T_A = 25^{\circ}C$ (Note 7) $T_A = T_{MAX}$ or T_{MIN} (Note 7)	●		±2 ±4	°C °C
Nonlinearity	$T_{MIN} \leq T_A \leq T_{MAX}$ (Note 4)		±1		°C

ELECTRICAL CHARACTERISTICS (Note 2, 3)

SYMBOL	PARAMETER	CONDITIONS	MIN	TYP	MAX	UNITS
$I_{ON\ LEAKAGE}$	On-Channel Leakage Current (Note 6)		●		±1	μA
$I_{OFF\ LEAKAGE}$	Off-Channel Leakage Current (Note 6)		●		±1	μA
V_{IH}	High Level Input Voltage	$V_{CC} = 5.25V$	●	2		V
V_{IL}	Low Level Input Voltage	$V_{CC} = 4.75V$	●		0.8	V
I_{IH}	High Level Input Current	$V_{IN} = V_{CC}$	●		5	μA
I_{IL}	Low Level Input Current	$V_{IN} = 0V$	●		-5	μA
V_{OH}	High Level Output Voltage	$V_{CC} = 4.75V, I_{OUT} = 10\mu A$ $V_{CC} = 4.75V, I_{OUT} = 360\mu A$	●	4.5 2.4	4.74 4.72	V V
V_{OL}	Low Level Output Voltage	$V_{CC} = 4.75V, I_{OUT} = 1.6mA$	●		0.4	V
I_{OZ}	Hi-Z Output Current	$\overline{CS} = High$	●		±5	μA
I_{SOURCE}	Output Source Current	$V_{OUT} = 0V$		-25		mA
I_{SINK}	Output Sink Current	$V_{OUT} = V_{CC}$		45		mA
I_{CC}	Supply Current	$\overline{CS} = High$ $\overline{CS} = Low, V_{CC} = 5V$	● ●	0.1 0.7	5 1	μA mA
t_{SMPL}	Analog Input Sample Time	See Figure 1		1.5		CLK Cycles
t_{CONV}	Conversion Time	See Figure 1		10		CLK Cycles
t_{dDO}	Delay Time, CLK↓ to D_{OUT} Data Valid	$C_{LOAD} = 100pF$	●	150	300	ns
t_{en}	Delay Time, CLK↓ to D_{OUT} Data Enabled	$C_{LOAD} = 100pF$	●	60	150	ns
t_{dis}	Delay Time, $\overline{CS} \uparrow$ to D_{OUT} Hi-Z		●	170	450	ns
t_{hDO}	Time Output Data Remains Valid After CLK↓	$C_{LOAD} = 100pF$		30		ns
t_f	D_{OUT} Fall Time	$C_{LOAD} = 100pF$	●	70	250	ns
t_r	D_{OUT} Rise Time	$C_{LOAD} = 100pF$	●	25	100	ns
C_{IN}	Input Capacitance	Analog Input On-Channel Analog Input Off-Channel Digital Input		30 5 5		pF pF pF

RECOMMENDED OPERATING CONDITIONS

SYMBOL	PARAMETER	CONDITIONS	MIN	TYP	MAX	UNITS
V_{CC}	Supply Voltage		4.5		6	V
f_{CLK}	Clock Frequency	$V_{CC} = 5V$	150	250	350	kHz
t_{CYC}	Total Cycle Time	$f_{CLK} = 250kHz$ Temperature Conversion Only	74 144			μs μs
t_{hDI}	Hold Time, D_{IN} After CLK↑	$V_{CC} = 5V$	150			ns
$t_{su\overline{CS}}$	Setup Time $\overline{CS} \downarrow$ Before First CLK↑ (See Figure 1)	$V_{CC} = 5V$	2			μs
t_{WAKEUP}	Wakeup Time $\overline{CS} \downarrow$ Before Start Bit↑ (See Figure 1)	$V_{CC} = 5V$ Temperature Conversion Only	10 80			μs μs
t_{suDI}	Setup Time, D_{IN} Stable Before CLK↑	$V_{CC} = 5V$	150			ns
t_{WHCLK}	Clock High Time	$V_{CC} = 5V$	1.6			μs
t_{WLCLK}	Clock Low Time	$V_{CC} = 5V$	2			μs
$t_{WH\overline{CS}}$	\overline{CS} High Time Between Data Transfer Cycles	$V_{CC} = 5V, f_{CLK} = 250kHz$	2			μs
$t_{WL\overline{CS}}$	\overline{CS} Low Time During Data Transfer	$V_{CC} = 5V, f_{CLK} = 250kHz$ Temperature Conversion Only	72 142			μs μs

RECOMMENDED OPERATING CONDITIONS

The ● denotes specifications which apply over the operating temperature range ($0^{\circ}\text{C} \leq T_A \leq 70^{\circ}\text{C}$ for commercial grade and $-40^{\circ}\text{C} \leq T_A \leq 85^{\circ}\text{C}$ for industrial grade).

Note 1: Absolute maximum ratings are those values beyond which the life of the device may be impaired.

Note 2: All voltage values are with respect to GND.

Note 3: Testing done at $V_{CC} = 5\text{V}$, $\text{CLK} = 250\text{kHz}$ and $T_A = 25^{\circ}\text{C}$ unless otherwise specified.

Note 4: Temperature integral nonlinearity is defined as the deviation of the A/D code versus temperature curve from the best-fit straight line over the device's rated temperature range.

Note 5: Voltage integral nonlinearity is defined as the deviation of a code from a straight line passing through the actual end points of the transfer curve.

Note 6: Channel leakage current is measured after the channel selection.

Note 7: See guaranteed temperature limit curves vs temperature range on the first page of this data sheet.

TYPICAL PERFORMANCE CHARACTERISTICS

**Differential Nonlinearity
Power Supply Voltage Mode**

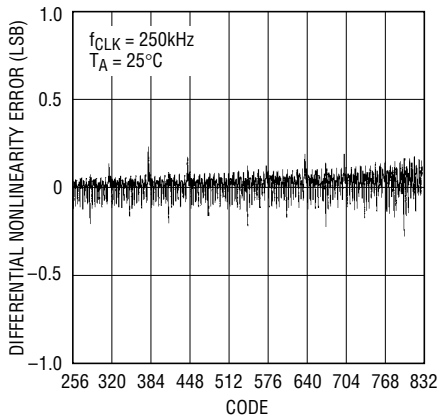

1392 G01

**Integral Nonlinearity
Power Supply Voltage Mode**

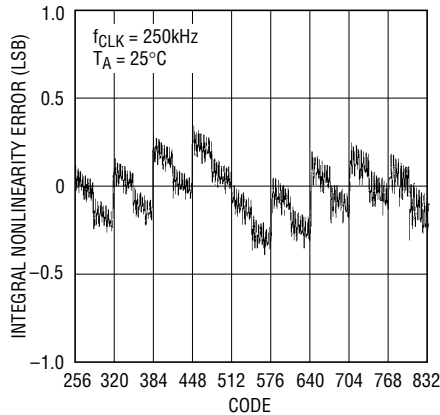

1392 G02

Differential Nonlinearity

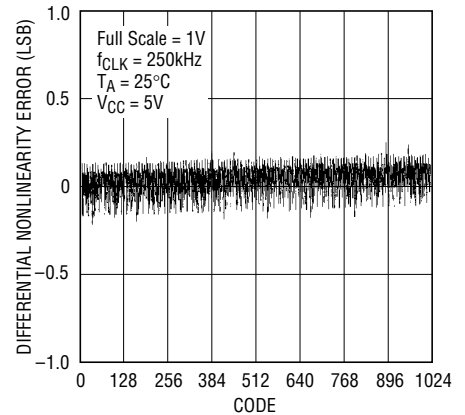

1392 G03

Integral Nonlinearity

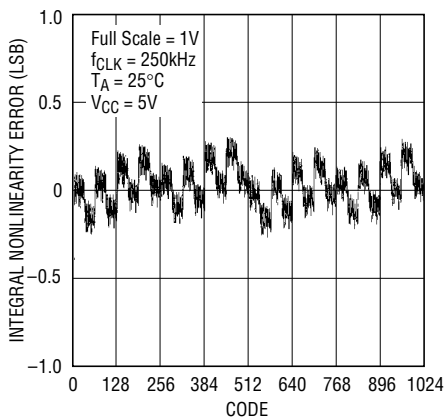

1392 G04

Differential Nonlinearity

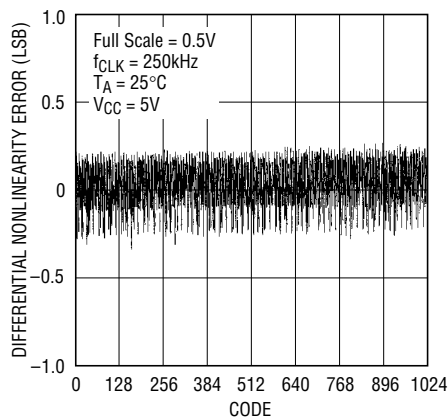

1392 G05

Integral Nonlinearity

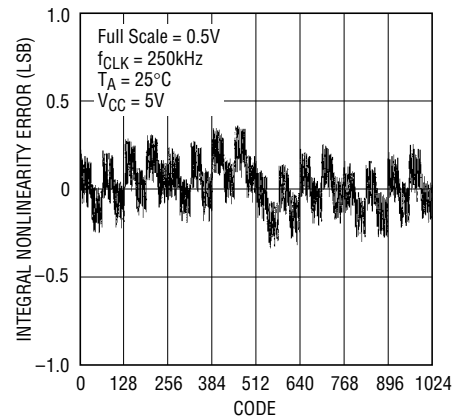

1392 G06

TYPICAL PERFORMANCE CHARACTERISTICS

Thermal Response in Stirred Oil Bath

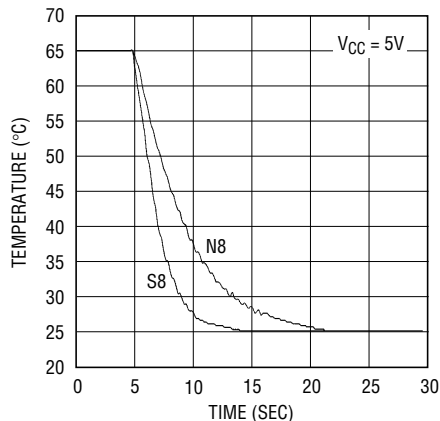

Thermal Response in Still Air

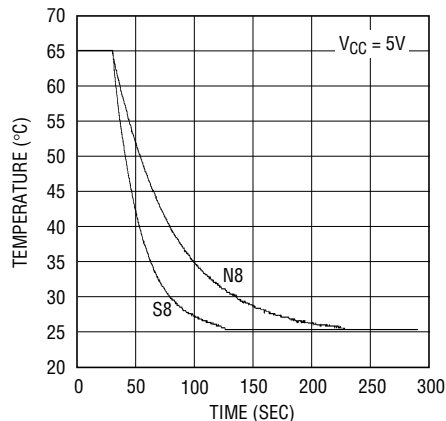

Supply Current vs Sample Rate

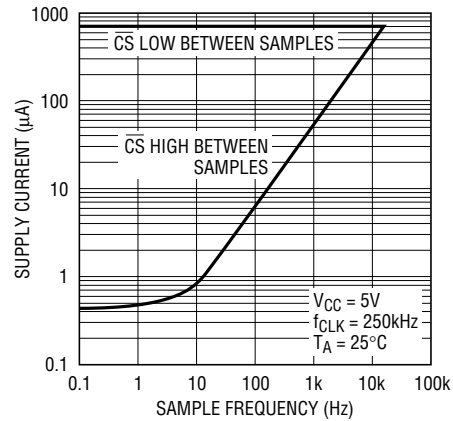

PIN FUNCTIONS

D_{IN} (Pin 1): Digital Input. The A/D configuration word is shifted into this input.

D_{OUT} (Pin 2): Digital Output. The A/D result is shifted out of this output.

CLK (Pin 3): Shift Clock. This clock synchronizes the serial data.

CS (Pin 4): Chip Select Input. A logic low on this input enables the LTC1392.

GND (Pin 5): Ground Pin. GND should be tied directly to an analog ground plane.

+V_{IN} (Pin 6): Positive Analog Differential Input. The pin can be used as a single-ended input by grounding $-V_{IN}$.

-V_{IN} (Pin 7): Negative Analog Differential Input. The input must be free from noise.

V_{CC} (Pin 8): Positive Supply. This supply must be kept free from noise and ripple by bypassing directly to the ground plane.

BLOCK DIAGRAM

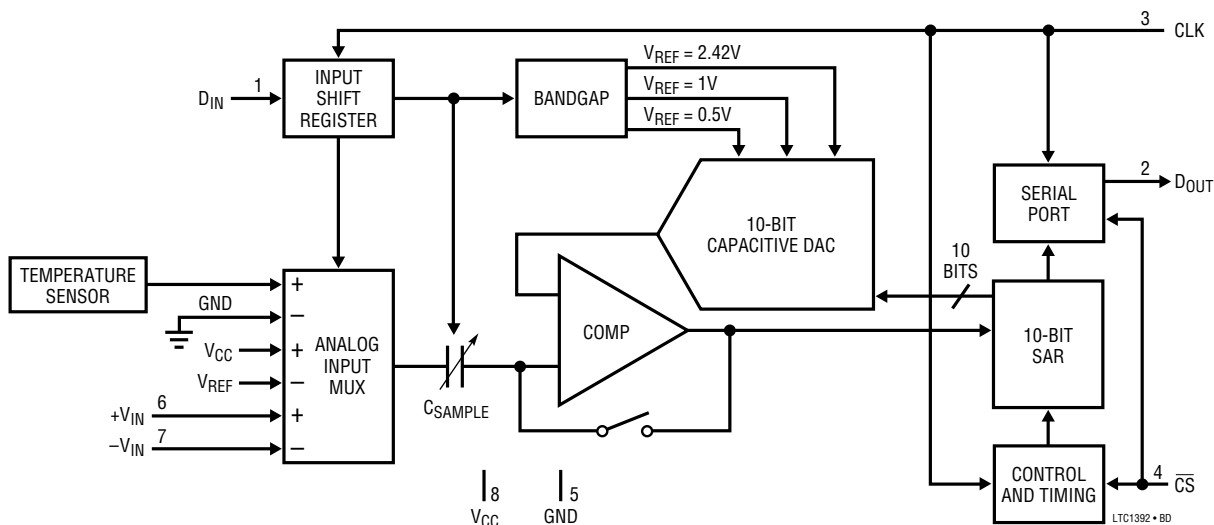

TEST CIRCUITS

Load Circuit for t_{dDO} , t_r and t_f

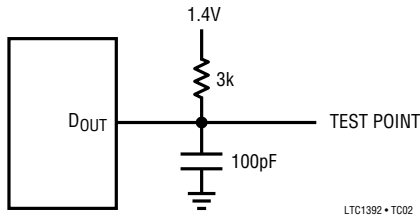

LTC1392 • TC02

Voltage Waveforms for D_{OUT} Delay Time, t_{dDO}

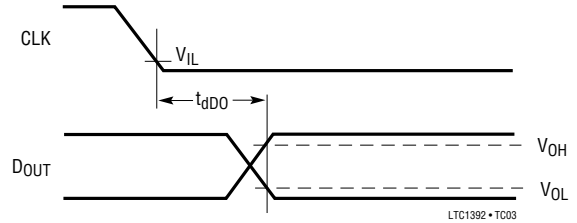

LTC1392 • TC03

Voltage Waveforms for D_{OUT} Rise and Fall Times, t_r and t_f

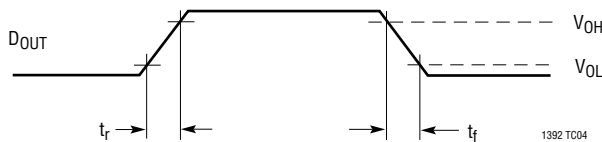

1392 TC04

Load Circuit for t_{dis} and t_{en}

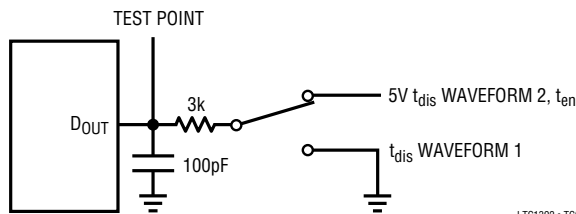

LTC1392 • TC05

Voltage Waveforms for t_{dis}

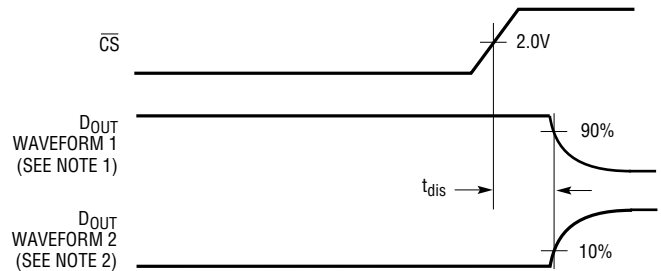

NOTE 1: WAVEFORM 1 IS FOR AN OUTPUT WITH INTERNAL CONDITIONS SUCH THAT THE OUTPUT IS HIGH UNTIL DISABLED BY THE OUTPUT CONTROL.
NOTE 2: WAVEFORM 2 IS FOR AN OUTPUT WITH INTERNAL CONDITIONS SUCH THAT THE OUTPUT IS LOW UNTIL DISABLED BY THE OUTPUT CONTROL.

LTC1392 • TC06

APPLICATIONS INFORMATION

The LTC1392 is a micropower data acquisition system designed to measure temperature, an on-chip power supply voltage and a differential input voltage. The LTC1392 contains the following functional blocks:

1. On-chip temperature sensor
2. 10-bit successive approximation capacitive ADC
3. Bandgap reference
4. Analog multiplexer (MUX)
5. Sample-and-hold (S/H)
6. Synchronous, half-duplex serial interface
7. Control and timing logic

DIGITAL CONSIDERATIONS

Serial Interface

The LTC1392 communicates with microprocessors and other external circuitry via a synchronous, half-duplex, 3-wire serial interface (see Figure 1). The clock (CLK) synchronizes the data transfer with each bit being transmitted on the falling CLK edge and captured on the rising CLK edge in both transmitting and receiving systems. The input data is first received and then the A/D conversion result is transmitted (half-duplex). Half-duplex operation allows D_{IN} and D_{OUT} to be tied together allowing transmission over three wires: \overline{CS} , CLK and DATA (D_{IN}/D_{OUT}). Data transfer is initiated by a falling chip select (\overline{CS}) signal. After the falling \overline{CS} is recognized, an 80 μ s delay is needed for

APPLICATIONS INFORMATION

MSB-First Data (MSBF = 1)

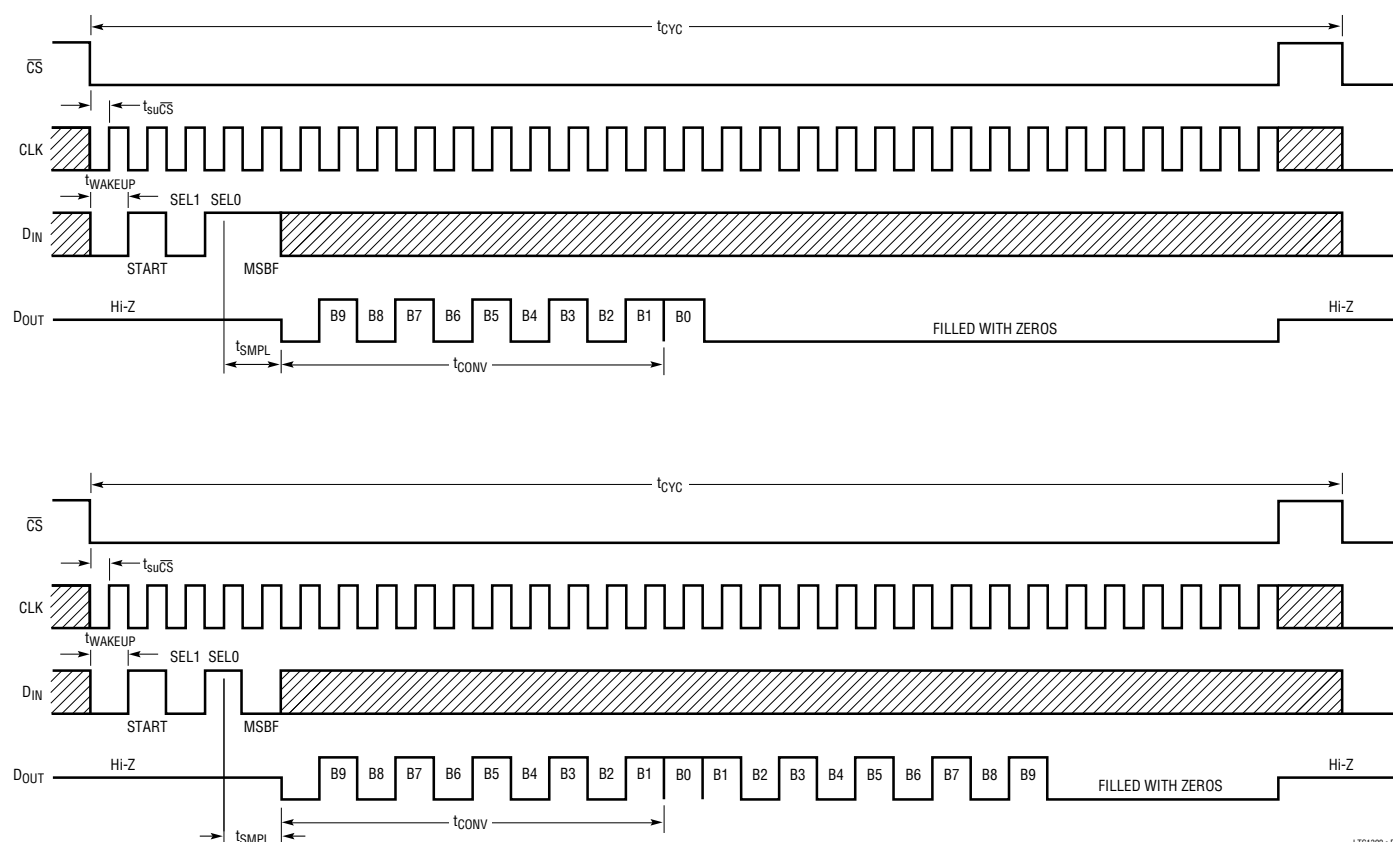

Figure 1

temperature measurement or a 10 μ s delay for other measurements, followed by a 4-bit input word which configures the LTC1392 for the current conversion. This data word is shifted into the D_{IN} input. D_{IN} is then disabled from shifting in any data and the D_{OUT} pin is configured from three-state to an output pin. A null bit and the result of the current conversion are serially transmitted on the falling CLK edge onto the D_{OUT} line. The format of the A/D result can be either MSB-first sequence or MSB-first sequence followed by an LSB-first sequence. This provides easy interface to MSB- or LSB-first serial ports. Bringing \overline{CS} high resets the LTC1392 for the next data exchange.

INPUT DATA WORD

Data transfer is initiated by a falling chip select (\overline{CS}) signal. After \overline{CS} falls, the LTC1392 looks for a start bit. Once the start bit is received, the next three bits are shifted into the

D_{IN} input which configures the LTC1392 and starts the conversion. Further inputs on the D_{IN} input are then ignored until the next \overline{CS} cycle. The four bits of the input word are defined as follows:

BIT 3	BIT 2	BIT 1	BIT 0
Start	Select 1	Select 0	MSBF

Start Bit

The first "logic one" clocked into the D_{IN} input after \overline{CS} goes low is the Start Bit. The Start Bit initiates the data transfer and all leading zeros which precede this logical one will be ignored. After the Start Bit is received the remaining bits of the input word will be clocked in. Further input on the D_{IN} pin are then ignored until the next \overline{CS} cycle.

APPLICATIONS INFORMATION

Measurement Mode Selections

The two bits of the input word following the Start Bit assign the measurement mode for the requested conversion. Table 1 shows the mode selections. Whenever there is a mode change from another mode to temperature measurement, a temperature mode initializing cycle is needed. The first temperature data measurement after a mode change should be ignored.

Table 1. Measurement Mode Selections

SELECT 1	SELECT 0	MEASUREMENT MODE
0	0	Temperature
0	1	Power Supply Voltage
1	0	Differential Input, 1V Full Scale
1	1	Differential Input, 0.5V Full Scale

MSB-First/LSB-First (MSBF)

The output data of the LTC1392 is programmed for MSB-first or LSB-first sequence using the MSBF bit. When the MSBF bit is a logical one, data will appear on the D_{OUT} line in MSB-first format. Logical zeros will be filled in indefinitely following the last data bit to accommodate longer word lengths required by some microprocessors. When the MSBF bit is a logical zero, LSB-first data will follow the normal MSB-first data on the D_{OUT} line.

CONVERSIONS

Temperature Conversion

The LTC1392 measures temperature through the use of an on-chip, proprietary temperature measurement technique. The temperature reading is provided in a 10-bit, unipolar format. Table 2 describes the exact relationship of output data to measured temperature or equation 1 can be used to calculate the temperature.

$$\text{Temperature (}^{\circ}\text{C)} = \text{Output Code}/4 - 130 \quad (1)$$

Note that the LTC1392C is only specified for operation over the 0°C to 70°C temperature range and the LTC1392I over the -40°C to 85°C range. Performance at tempera-

tures outside these specified temperature ranges is not guaranteed and errors may be greater than those shown in the Electrical Characteristics table.

Table 2. Codes for Temperature Conversion

OUTPUT CODE	TEMPERATURE (°C)
1111111111	125.75
1111111110	125.50
...	...
1001101101	25.25
1001101100	25.00
1001101011	24.75
...	...
0000000001	-129.75
0000000000	-130.00

Voltage Supply (V_{CC}) Monitor

The LTC1392 measures supply voltage through the on-chip V_{CC} supply line. The V_{CC} reading is provided in a 10-bit, unipolar format. Table 3 describes the exact relationship of output data to measured V_{CC} or equation (2) can be used to calculate the measured V_{CC}.

$$\text{Measured } V_{CC} = [(\text{Output Code}) \cdot 4.84/1024] + 2.42 \quad (2)$$

The guaranteed supply voltage monitor range is from 4.5V to 6V. Typical parts are able to maintain measurement accuracy with V_{CC} as low as 3.25V. The typical INL and DNL error plots shown on page 4 are measured with V_{CC} from 3.63V to 6.353V.

Table 3. Codes for Voltage Supply Conversion

OUTPUT CODE	Supply Voltage (V _{CC})
1011110110	6.003V
1011110101	5.998V
...	...
1000100010	5.001V
...	...
0110111001	4.504V
0110111000	4.500V

APPLICATIONS INFORMATION

Differential Voltage Conversion

The LTC1392 measures the differential input voltage through pins $+V_{IN}$ and $-V_{IN}$. Input ranges of 0.5V or 1V full scale are available for differential voltage measurement with resolutions of 10 bits. Tables 4a and 4b describe the exact relationship of output data to measured differential input voltage in the 1V and 0.5V input range. Equations (3) and (4) can be used to calculate the differential voltage in the 1V and 0.5V input voltage range respectively. The output code is in unipolar format.

$$\text{Differential Voltage} = 1V \cdot (10\text{-bit code})/1024 \quad (3)$$

$$\text{Differential Voltage} = 0.5V \cdot (10\text{-bit code})/1024 \quad (4)$$

Table 4a. Codes for 1V Differential Voltage Range

OUTPUT CODE	INPUT VOLTAGE	INPUT RANGE = 1V	REMARKS
1111111111	1V – 1LSB	999.0mV	
1111111110	1V – 2LSB	998.0mV	
...	
0000000001	1LSB	0.977mV	1LSB = 1/1024
0000000000	0LSB	0.00mV	

Table 4b. Codes for 0.5V Differential Voltage Range

OUTPUT CODE	INPUT VOLTAGE	INPUT RANGE = 0.5V	REMARKS
1111111111	0.5V – 1LSB	499.5mV	
1111111110	0.5V – 2LSB	499.0mV	
...	
0000000001	1LSB	0.488mV	1LSB = 0.5/1024
0000000000	0LSB	0.00mV	

Thermal Coupling/Airflow

The supply current of the LTC1392 is 700 μ A typically when running at the maximum conversion rate. The equivalent power dissipation of 3.5mW causes a temperature rise of 0.455 $^{\circ}$ C in the SO8 and 0.35 $^{\circ}$ C in PDIP packages due to self-heating effects. At sampling rates less than 400 samples per second, less than 20 μ A current is drawn from the supply (see Typical Performance Characteristics) and the die self-heating effect is negligible. This LTC1392 can be attached to a surface (such as microprocessor chip or a heat sink) for precision temperature monitoring. The package leads are the principal path to carry the heat into the device; thus any wiring leaving the device should be held at the same temperature as the surface. The easiest way to do this is to cover up the wires with a bead of epoxy which will ensure that the leads and wires are at the same temperature as the surface. The thermal time constant of the LTC1392 in still air is about 22 seconds (see the graph in the Typical Performance Characteristics section). Attaching an LTC1392 to a small metal fin (which also provides a small thermal mass) will help reduce thermal time constant, speed up the response and give the steadyest reading in slow moving air.

PACKAGE DESCRIPTION Dimensions in inches (millimeters) unless otherwise noted.

N8 Package
8-Lead PDIP (Narrow 0.300)
 (LTC DWG # 05-08-1510)

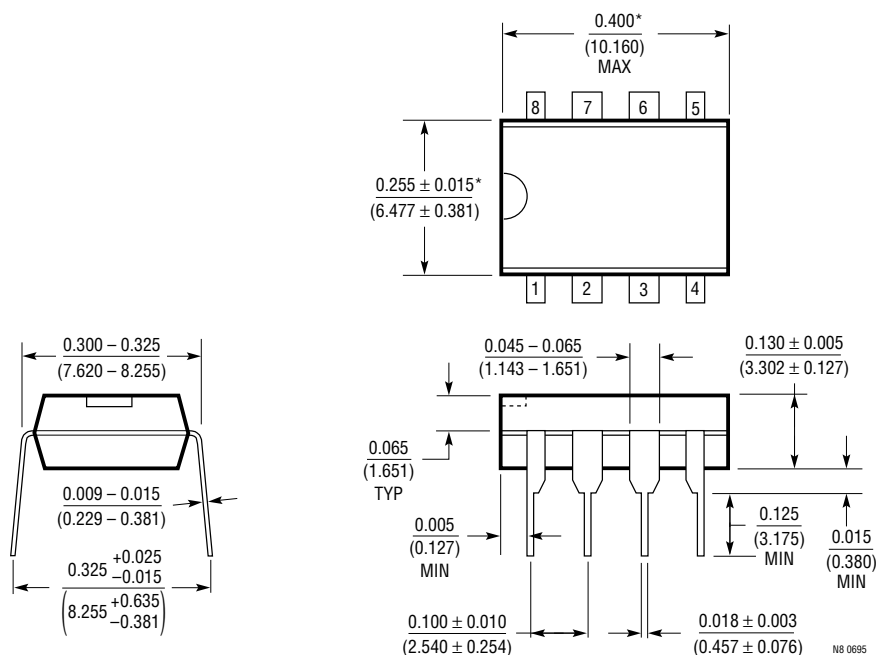

*THESE DIMENSIONS DO NOT INCLUDE MOLD FLASH OR PROTRUSIONS.
 MOLD FLASH OR PROTRUSIONS SHALL NOT EXCEED 0.010 INCH (0.254mm)

S8 Package
8-Lead Plastic Small Outline (Narrow 0.150)
 (LTC DWG # 05-08-1610)

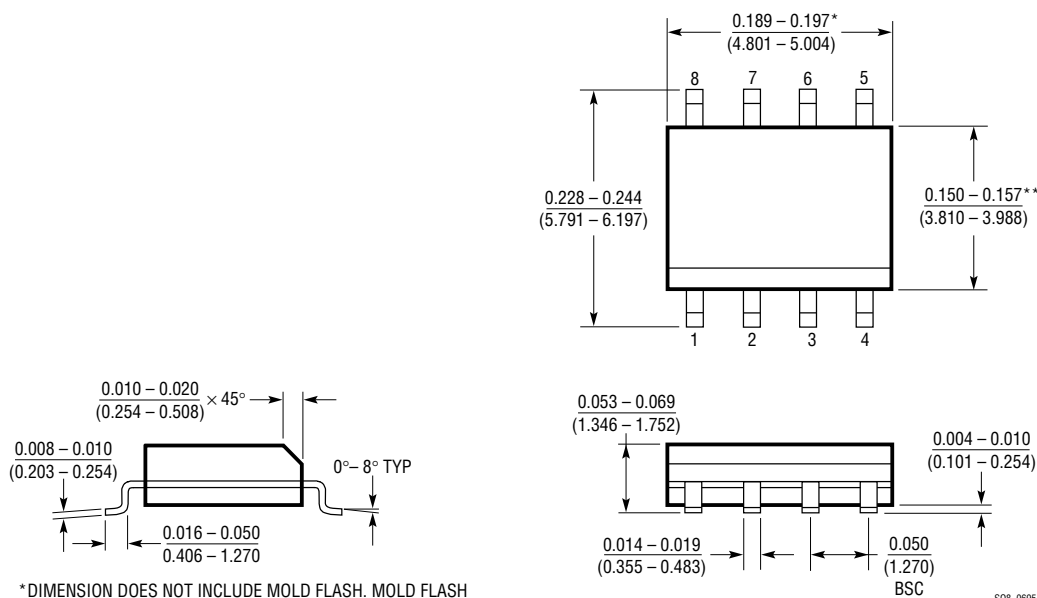

*DIMENSION DOES NOT INCLUDE MOLD FLASH. MOLD FLASH SHALL NOT EXCEED 0.006" (0.152mm) PER SIDE
 **DIMENSION DOES NOT INCLUDE INTERLEAD FLASH. INTERLEAD FLASH SHALL NOT EXCEED 0.010" (0.254mm) PER SIDE