

### FEATURES

- 200mV Max Dropout at 10mA Output Current
- 4 $\mu$ A Typical Quiescent Current
- 0.15% Max Initial Accuracy
- No Output Capacitor Required
- Output Sources 10mA, Sinks 2mA
- 40ppm/ $^{\circ}$ C Max Drift
- Voltage Options: 2.5V, 3V, 4.1V, 5V and Adjustable

### APPLICATIONS

- Battery-Powered Systems
- Handheld Instruments
- Precision Power Supplies
- A/D and D/A Converters
- Available in the SO-8 Package

LT, LT, LTC, LTM, Linear Technology and the Linear logo are registered trademarks of Linear Technology Corporation. All other trademarks are the property of their respective owners.

### DESCRIPTION

The LTC<sup>®</sup>1798/LTC1798-2.5/LTC1798-3/LTC1798-4.1/LTC1798-5 are micropower bandgap references that combine high accuracy and low drift with very low supply current and small package size. The combination of ultralow quiescent current and low dropout voltage of only 200mV (max) makes them ideal for battery-powered equipment. The output voltage is set by an external resistor divider for the adjustable LTC1798.

This series of references uses curvature compensation to obtain low temperature coefficient and trimmed thin-film resistors to achieve high output accuracy. These references can source up to 10mA and sink up to 2mA, making them ideal for precision regulator applications. They are stable without an output bypass capacitor, but are also stable with capacitance up to 1 $\mu$ F. This feature is important in critical applications where PC board space is a premium and fast settling is demanded.

The LTC1798 series references provided power dissipation advantages over shunt references. In addition to supply current, shunt references must also idle the entire load current to operate.

The LTC1798 series is available in the SO-8 package.

### TYPICAL APPLICATION

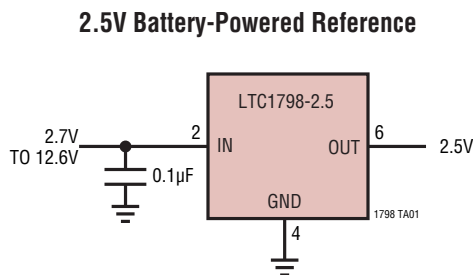

**LTC1798-2.5 Temperature Drift**

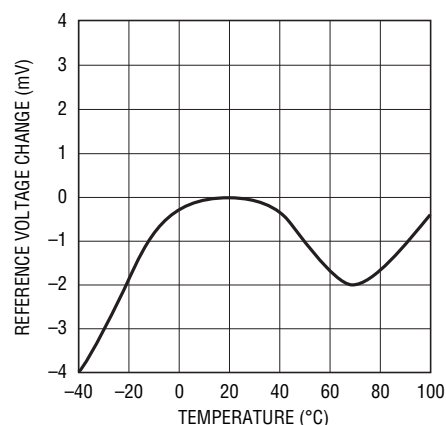

1798 TA02

1798fc

# LTC1798 Series

## ABSOLUTE MAXIMUM RATINGS

(Note 1)

Operating Temperature Range.....	0°C to 70°C
Extended Commercial Operating Temperature Range.....	-40°C to 85°C
Junction Temperature .....	110°C
Storage Temperature Range.....	-65°C to 150°C
Lead Temperature (Soldering, 10 sec) .....	300°C

## PIN CONFIGURATION

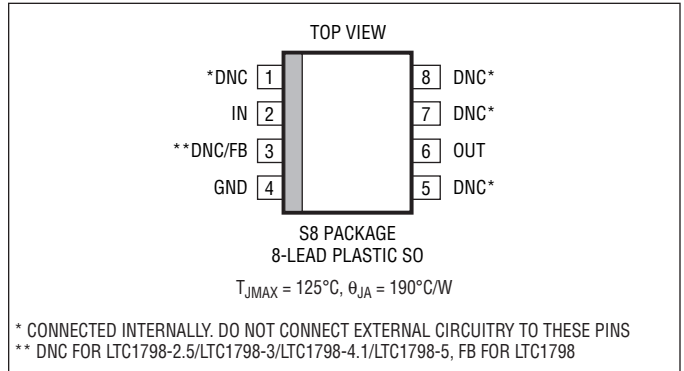

## ORDER INFORMATION

LEAD FREE FINISH	TAPE AND REEL	PART MARKING	PACKAGE DESCRIPTION	SPECIFIED TEMPERATURE RANGE
LTC1798CS8#PBF (OBSOLETE)	LTC1798CS8#TRPBF	1798	8-Lead Plastic SO	0°C to 70°C
LTC1798CS8-2.5#PBF	LTC1798CS8-2.5#TRPBF	179825	8-Lead Plastic SO	0°C to 70°C
LTC1798CS8-3#PBF	LTC1798CS8-3#TRPBF	17983	8-Lead Plastic SO	0°C to 70°C
LTC1798CS8-4.1#PBF	LTC1798CS8-4.1#TRPBF	179841	8-Lead Plastic SO	0°C to 70°C
LTC1798CS8-5#PBF	LTC1798CS8-5#TRPBF	17985	8-Lead Plastic SO	0°C to 70°C

Consult LTC Marketing for parts specified with wider operating temperature ranges.

Consult LTC Marketing for information on non-standard lead based finish parts.

For more information on lead free part marking, go to: <http://www.linear.com/leadfree/>

For more information on tape and reel specifications, go to: <http://www.linear.com/tapeandreel/>

## AVAILABLE OPTIONS

OUTPUT VOLTAGE (V)	TEMPERATURE RANGE (°C)	ACCURACY (%)	TEMPERATURE COEFFICIENT (PPM/°C)	PACKAGE STYLE	
				SO-8 (S8)	
				ORDER NUMBER	PART MARKING
2.5	0 to 70	0.15	40	LTC1798CS8-2.5	179825
3	0 to 70	0.15	40	LTC1798CS8-3	17983
4.096	0 to 70	0.15	40	LTC1798CS8-4.1	179841
5	0 to 70	0.15	40	LTC1798CS8-5	17985
Adjustable	0 to 70	0.4	40	LTC1798CS8	1798

1798fc

## ELECTRICAL CHARACTERISTICS

The ● denotes specifications which apply over the full specified temperature range, otherwise specifications are at  $T_A = 25^\circ\text{C}$ .  $V_{IN} = V_{OUT(NOMINAL)} + 0.2\text{V}$ ,  $I_{OUT} = 0\text{mA}$  unless otherwise noted. FB = OUT for the LTC1798.

SYMBOL	PARAMETER	CONDITIONS	MIN	TYP	MAX	UNITS
$V_{IN}$	Input Voltage Range				12.6	V
$I_{IN}$	Input Current	FB = OUT for LTC1798		4	6.5 8.5	$\mu\text{A}$ $\mu\text{A}$
$V_{OUT}$	Output Voltage (Note 4)	LTC1798, FB = OUT LTC1798 ADJ LTC1798-2.5 LTC1798-3 LTC1798-4.1 LTC1798-5 LTC1798 All Fixed Options	2.3755 -0.4 2.4963 2.9955 4.090 4.9925 -0.15	2.385 0.4 2.5 3 4.096 5	2.3945 0.4 2.5037 3.0045 4.102 5.0075 0.15	V % V V V V %
$e_n$	Output Voltage Noise (Note 5)	$0.1\text{Hz} \leq f \leq 10\text{Hz}$		8		ppmP-P
TC	Output Voltage Temp Coefficient (Note 6)	$T_{MIN} \leq T_J \leq T_{MAX}$		15	40	ppm/ $^\circ\text{C}$
$V_{OUT}/V_{IN}$	Line Regulation	$V_{IN} = (V_{OUT(NOMINAL)} + 0.2\text{V})$ to 12.6V		30	120	ppm/V
$V_{OUT}/I_{OUT}$	Load Regulation (Note 7)	Sourcing 0mA to 10mA Sinking 0mA to 2mA		0.1 1.75	0.3 4 6.5	mV/mA mV/mA mV/mA
$I_{SC}$	Short-Circuit Output Current	$V_{OUT}$ Shorted to GND $V_{OUT}$ Shorted to $V_{IN}$	20 2	40 4		mA mA
$\Delta V_{DO}$	Dropout Voltage (Note 8)	$I_{OUT} = 0$ , $\Delta V_{OUT} \leq 0.1\%$ $I_{OUT} = 10\text{mA}$ , $\Delta V_{OUT} \leq 0.1\%$			100 200	mV mV
$V_{HYST}$	Output Hysteresis (Note 9)	$\Delta T = -40^\circ\text{C}$ to $85^\circ\text{C}$ $\Delta T = 0^\circ\text{C}$ to $70^\circ\text{C}$		200 50		ppm ppm
$I_{FB}$	FB Pin Input Current	LTC1798, OUT = FB		10		nA

**Note 1:** Stresses beyond those listed under Absolute Maximum Ratings may cause permanent damage to the device. Exposure to any Absolute Maximum Rating condition for extended periods may affect device reliability and lifetime.

**Note 2:** The LTC1798 is guaranteed functional over the operating temperature range of  $-40^\circ\text{C}$  to  $100^\circ\text{C}$ .

**Note 3:** If the part is stored outside of the specified operating temperature range, the output may shift due to hysteresis.

**Note 4:** ESD (Electrostatic Discharge) sensitive device. Extensive use of ESD protection devices are used internal to the LTC1798, however, high electrostatic discharge can damage or degrade the device. Use proper ESD handling precautions.

**Note 5:** Peak-to-peak noise is measured with a single pole highpass filter at 0.1Hz and 2-pole lowpass filter at 10Hz.

**Note 6:** Temperature coefficient is the change in output voltage divided by the nominal output voltage divided by the specified temperature range.

**Note 7:** Load regulation is measured on a pulse basis from no load to the specified load current. Output changes due to die temperature change must be taken into account separately.

**Note 8:** Dropout voltage is  $(V_{IN} - V_{OUT})$  when  $V_{OUT}$  falls to 0.1% below its nominal value at  $V_{IN} = V_{OUT} + 0.5\text{V}$ .

**Note 9:** Hysteresis in output voltage is created by package stress that differs depending on whether the IC was previously at a higher or lower temperature. Output voltage is always measured at  $25^\circ\text{C}$ , but the IC is cycled hot or cold before successive measurements. Hysteresis is not normally a problem for operational temperature excursions where the instrument might be stored at high or low temperature.

## TYPICAL PERFORMANCE CHARACTERISTICS

**LTC1798-2.5\* Dropout Voltage vs Output Source Current**

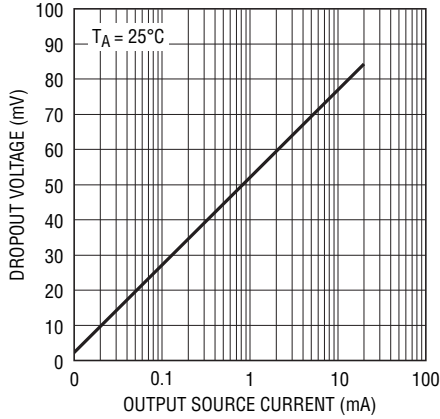

1798 G01

**LTC1798-2.5\* Input Current vs Temperature**

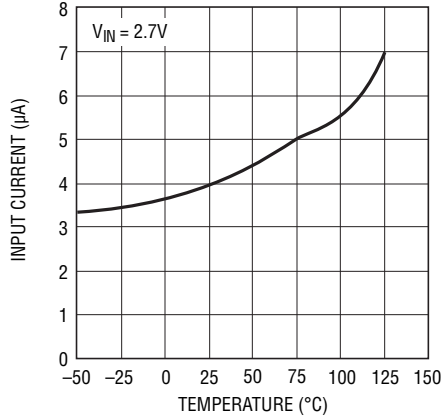

1798 G02

**LTC1798 Series Output Short-Circuit Current vs Temperature**

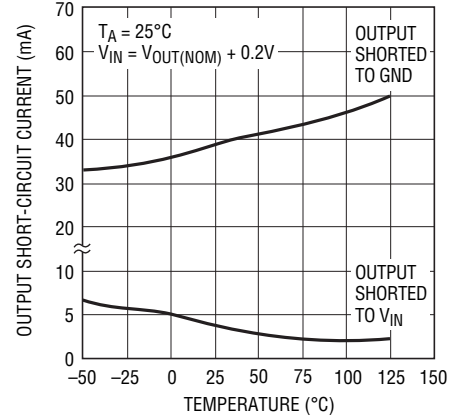

1798 G03

**LTC1798-2.5\* Output Short-Circuit Current vs Input Voltage**

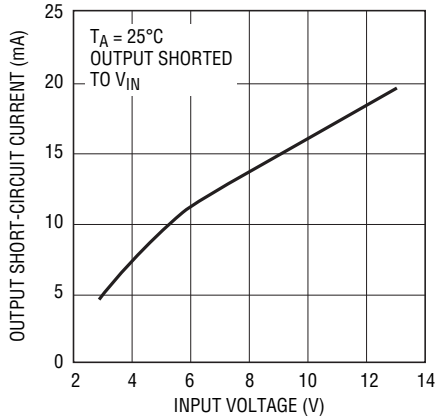

1798 G04

**LTC1798-2.5\* Output Short-Circuit Current vs Input Voltage**

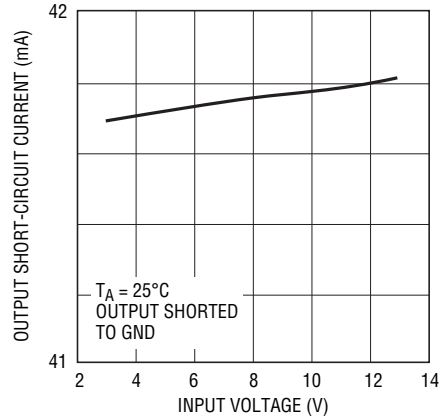

1798 G05

**LTC1798 Series Load Regulation**

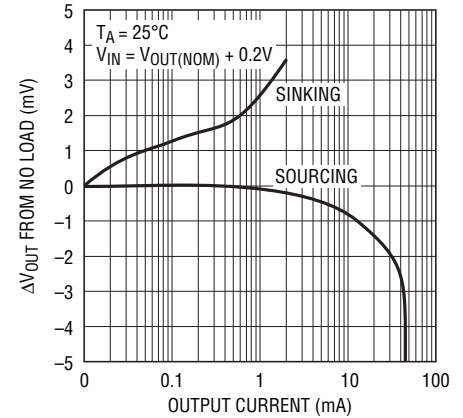

1798 G06

**LTC1798-2.5\* Output Voltage vs Input Voltage**

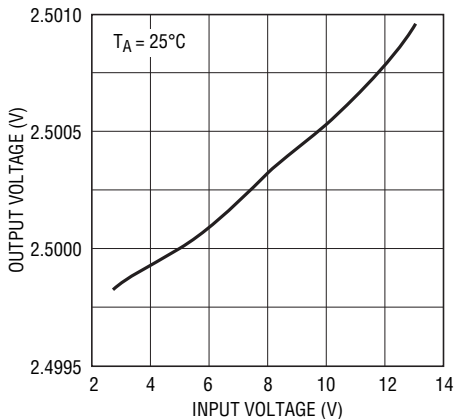

1798 G07

**LTC1798-2.5\* Input Current vs Input Voltage**

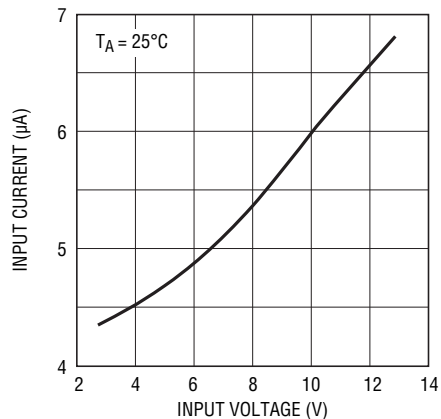

1798 G08

**LTC1798-2.5 PSRR vs Frequency**

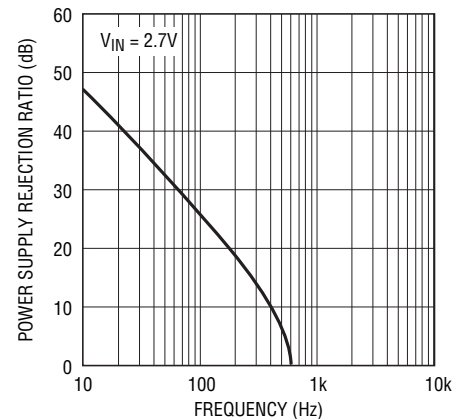

1798 G09

## TYPICAL PERFORMANCE CHARACTERISTICS

**LTC1798-2.5**  
0.1Hz to 10Hz Noise

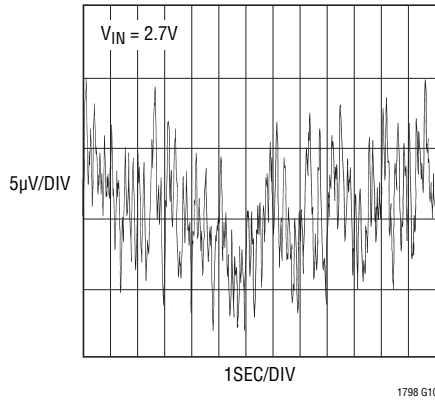

**LTC1798-5 Input Current vs Input Voltage in Dropout**

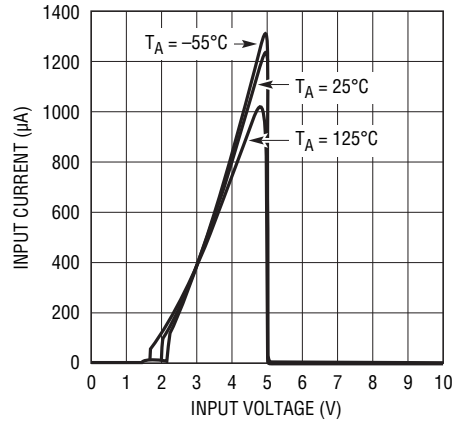

**LTC1798-2.5 Input Current vs Input Voltage in Dropout**

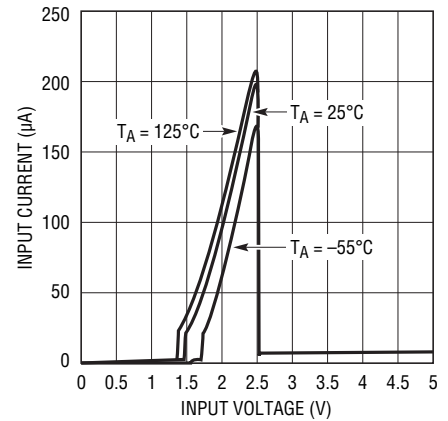

## PIN FUNCTIONS

**DNC (Pins 1, 5, 7, 8):** Do Not Connect. Connected internally for post package trim. These pins must be left unconnected.

**IN (Pin 2):** Positive Supply. Bypassing with a 0.1µF capacitor is recommended if the output loading changes. ( $V_{OUT} + 0.2V \leq V_{IN} \leq 12.6V$ ).

**DNC (Pin 3):** (LTC1798-2.5/LTC1798-3/LTC1798-4.1/LTC1798-5) Do Not Connect. Connected internally for post package trim. This pin must be left unconnected.

**FB (Pin 3):** (LTC1798) Resistor Divider Feedback Pin. Connect a resistor divider from OUT to GND and the center tap to FB. This pin sets the output potential.

$V_{OUT} = 2.385V \left( \frac{R1 + R2}{R2} \right)$ ; R1 is connected from OUT to FB and R2 from FB to GND. Selecting  $R2 \geq 10k$  will make  $I_{OUT} < 250\mu A$ .

**GND (Pin 4):** Negative Supply or Ground Connection.

**OUT (Pin 6):** Reference Output. The output can source up to 10mA and sink up to 2mA. It is stable with output bypass capacitor ranging from 0µF to 1µF.

## BLOCK DIAGRAM

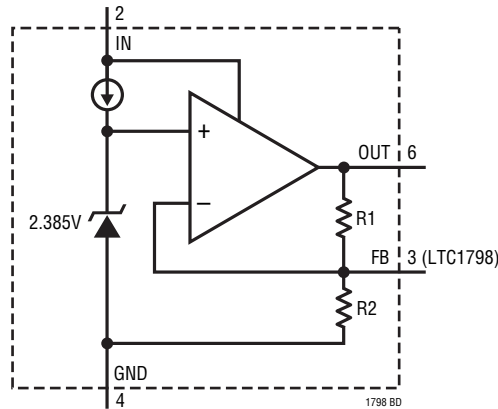

NOTE: R1 AND R2 ARE NOT CONNECTED FOR LTC1798

## APPLICATIONS INFORMATION

### Longer Battery Life

Series references have an advantage over shunt style references. To operate, shunt references require a resistor between the power supply and the output. This resistor must be chosen to supply the maximum current that is demanded by the circuit being regulated. When the circuit being controlled is not operating at this maximum current, the shunt reference must always sink this current, resulting in high power dissipation and short battery life.

The LTC1798 series low dropout references do not require a current setting resistor and can operate with any supply voltage from  $(V_{OUT(NOMINAL)} + 0.2V)$  to 12.6V. When the circuitry being regulated does not demand current, the LTC1798 series reduces its dissipation and battery life is extended. If the reference is not delivering load current it

dissipates only 10.8 $\mu$ W when operating on a 2.7V supply for LTC1798-2.5, yet the same connection can deliver 10mA of load current when demanded.

### Output Bypass Capacitor

The LTC1798 series is designed to be stable with or without capacitive loads. With no capacitive load, the reference is ideal for fast settling applications, or where PC board space is at a premium.

In applications with significant output loading changes, an output bypass capacitor of up to 1 $\mu$ F can be used to improve the output transient response. Figure 1 shows the response of the reference to a 1mA to 0 $\mu$ A load step with a 1 $\mu$ F output capacitor. If more than 1 $\mu$ F of output capacitance is required, a resistor in series with the capacitor is recommended

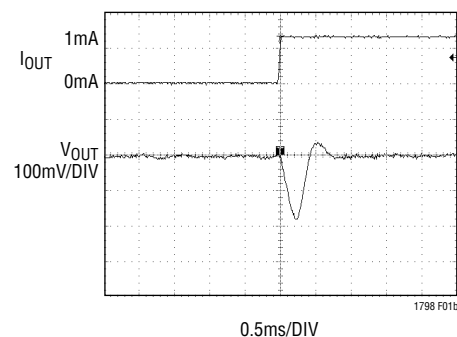
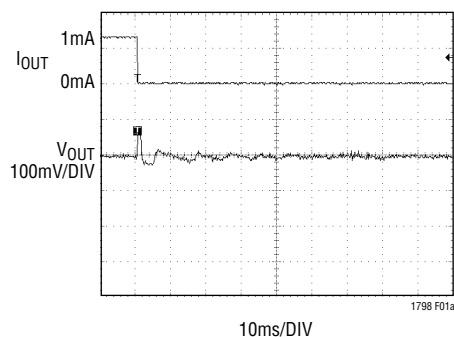

Figure 1. Reference Output Load Transient Response, 1 $\mu$ F Output Capacitor

## APPLICATIONS INFORMATION

to reduce the output ringing. Figure 2 illustrates the use of a damping resistor for capacitive loads greater than 1 $\mu$ F. Figure 3 shows the resistor and capacitor values required to achieve critical damping.

### Internal P-Channel Pass Transistor

The LTC1798 series features an internal P-channel MOSFET pass transistor. This provides several advantages over similar designs using a PNP bipolar pass transistor.

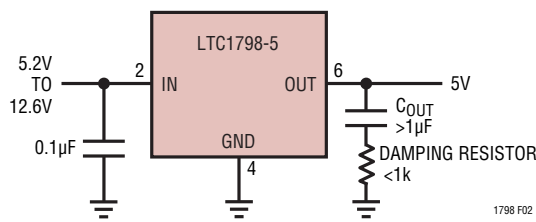

**Figure 2. Adding a Damping Resistor with Output Capacitors Greater Than 1 $\mu$ F**

These references consume only 4 $\mu$ A of quiescent current under light and heavy loads as well as in dropout; whereas, PNP-based references waste considerable amounts of current when the pass transistor is saturated. In addition, the LTC1798 series provides a lower dropout voltage (200mV max) than PNP-based references.

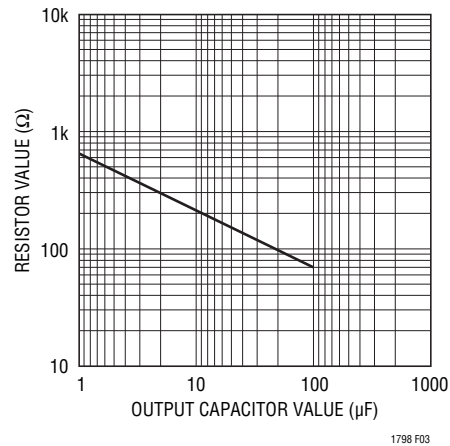

**Figure 3. Damping Resistance vs Output Capacitor Value**

## PACKAGE DESCRIPTION Dimensions in inches (millimeters) unless otherwise noted.

### S8 Package 8-Lead Plastic Small Outline (Narrow .150 Inch) (Reference LTC DWG # 05-08-1610)

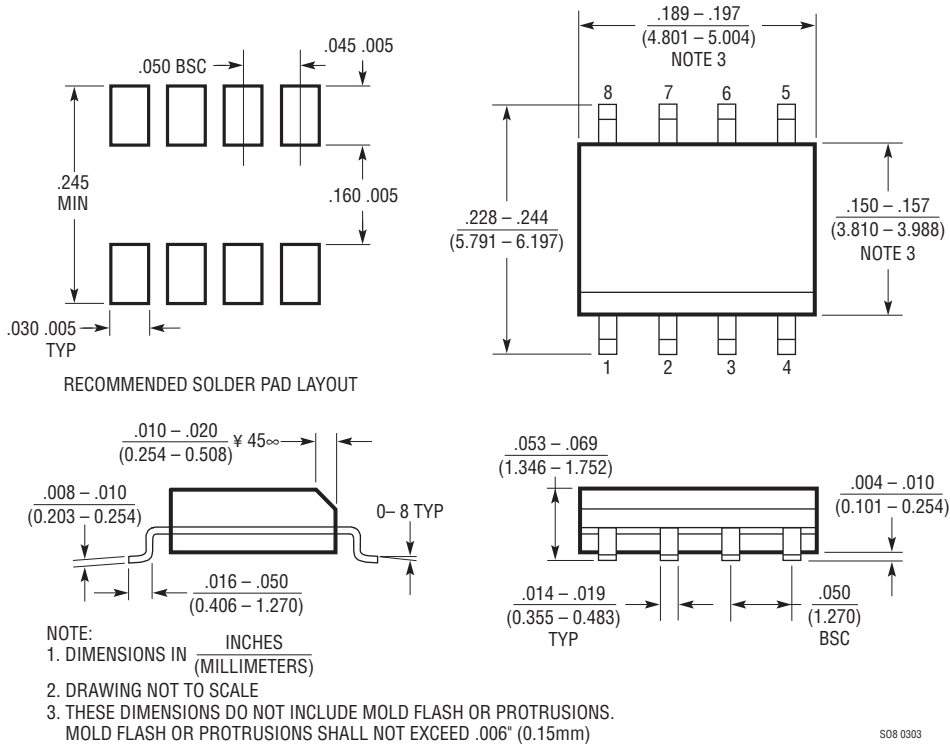



**REVISION HISTORY** (Revision history begins at Rev C)

REV	DATE	DESCRIPTION	PAGE NUMBER
C	9/10	Added Maximum limit for $V_{IN}$ in Electrical Characteristics section	3