

MAIN/CAM LED Controller with 64-Step Brightness Control in 3mm × 3mm QFN

FEATURES

- Low Noise Charge Pump Provides High Efficiency with Automatic Mode Switching
- Multimode Operation: 1x, 1.5x, 2x
- Individual Full-Scale Current Set Resistors
- Up to 500mA Total Output Current
- Single Wire EN/Brightness Control for MAIN and CAM LEDs
- 64:1 Linear Brightness Control Range for MAIN Display
- Four 25mA Low Dropout MAIN LED Outputs
- One 400mA Low Dropout CAM LED Output
- Low Noise Constant-Frequency Operation
- Low Shutdown Current: 3μA
- Internal Soft-Start Limits Inrush Current During Startup and Mode Switching
- Open/Short LED Protection
- No Inductors
- 3mm × 3mm × 0.75mm 16-Lead Plastic QFN Package

APPLICATIONS

- Multi-LED Light Supply for Cell Phones/DSCs/PDAs

LT, LT, LTC, LTM, Linear Technology and the Linear logo are registered trademarks and ThinSOT is a trademark of Linear Technology Corporation. All other trademarks are the property of their respective owners.

DESCRIPTION

The LTC[®]3210-1 is a low noise charge pump DC/DC converter designed to drive four MAIN LEDs and one high current CAM LED for camera lighting. The LTC3210-1 requires only four small ceramic capacitors and two current set resistors to form a complete LED power supply and current controller.

Built-in soft-start circuitry prevents excessive inrush current during start-up and mode changes. High switching frequency enables the use of small external capacitors. Independent MAIN and CAM full-scale current settings are programmed by two external resistors.

Shutdown mode and current output levels are selected via two logic inputs. ENM and ENC are toggled to adjust the LED currents via internal counters and DACs. A 6-bit linear DAC (64 steps) provides high resolution brightness control for the MAIN display.

The charge pump optimizes efficiency based on the voltage across the LED current sources. The part powers up in 1x mode and will automatically switch to boost mode whenever any enabled LED current source begins to enter dropout. The LTC3210-1 is available in a 3mm × 3mm × 0.75mm 16-lead QFN package.

TYPICAL APPLICATION

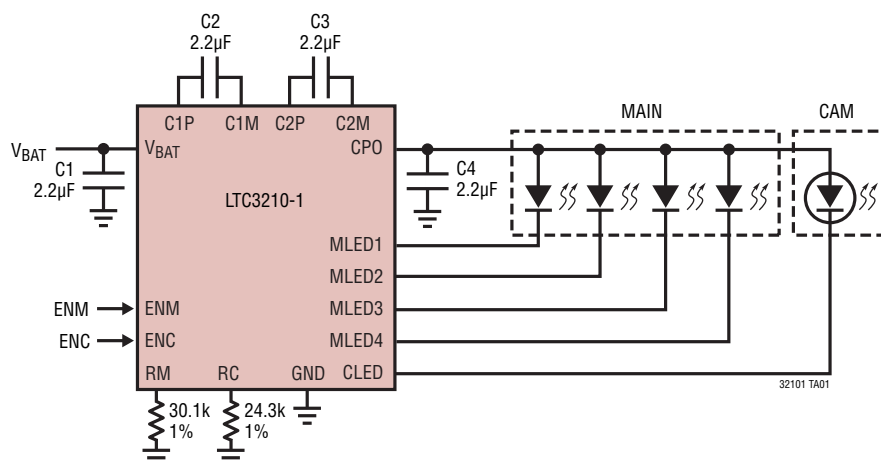

4-LED MAIN Display
Efficiency vs V_{BAT} Voltage

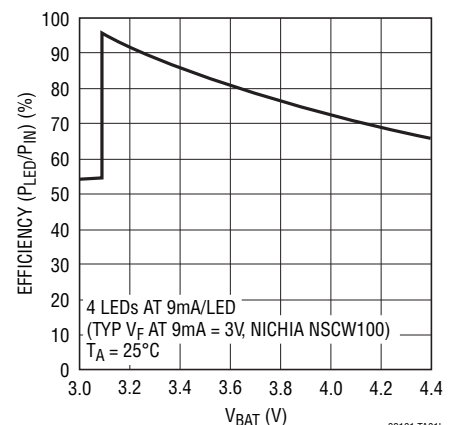

ABSOLUTE MAXIMUM RATINGS

(Note 1)

V_{BAT} , CPO to GND	-0.3V to 6V
ENM, ENC	-0.3V to ($V_{BAT} + 0.3V$)
I_{CPO} (Note 2)	600mA
$I_{MLED1-4}$	35mA
I_{CLED} (Note 2)	500mA
CPO Short-Circuit Duration	Indefinite
Operating Temperature Range (Note 3) ...	-40°C to 85°C
Storage Temperature Range	-65°C to 125°C

PIN CONFIGURATION

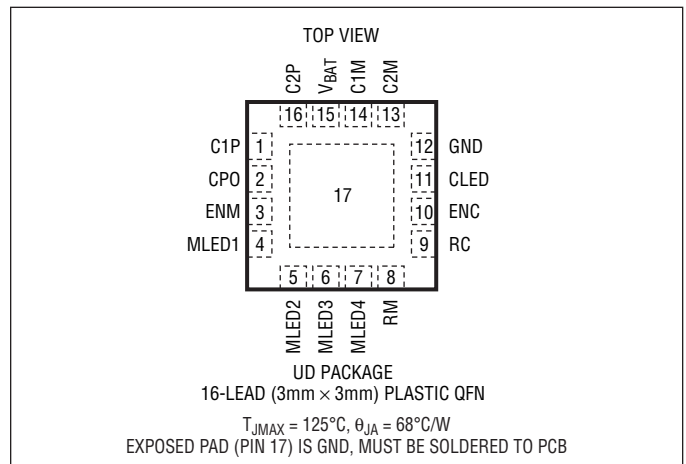

ORDER INFORMATION

LEAD FREE FINISH	TAPE AND REEL	PART MARKING	PACKAGE DESCRIPTION	TEMPERATURE RANGE
LTC3210EUD-1#PBF	LTC3210EUD-1#TRPBF	LCBT	16-Lead (3mm × 3mm) Plastic QFN	-40°C to 85°C
LTC3210EPD-1#PBF	LTC3210EPD-1#TRPBF	LCXT	16-Lead (3mm × 3mm) Plastic UTQFN	-40°C to 85°C (OBSOLETE)

Consult LTC Marketing for parts specified with wider operating temperature ranges.

Consult LTC Marketing for information on non-standard lead based finish parts.

For more information on lead free part marking, go to: <http://www.linear.com/leadfree/>

For more information on tape and reel specifications, go to: <http://www.linear.com/tapeandree/>

ELECTRICAL CHARACTERISTICS The ● denotes the specifications which apply over the full operating temperature range, otherwise specifications are at $T_A = 25^{\circ}C$. $V_{BAT} = 3.6V$, $C1 = C2 = C3 = C4 = 2.2\mu F$, $RM = 30.1k$, $RC = 24.3k$, $ENM = high$, unless otherwise noted.

PARAMETER	CONDITIONS	MIN	TYP	MAX	UNITS	
V_{BAT} Operating Voltage	●	2.9		4.5	V	
I_{VBAT} Operating Current	$I_{CPO} = 0$, 1x Mode, LSB Setting		0.4		mA	
	$I_{CPO} = 0$, 1.5x Mode		2.5		mA	
	$I_{CPO} = 0$, 2x Mode		4.5		mA	
V_{BAT} Shutdown Current	ENM = ENC = Low	●	3	6	μA	
MLED1, MLED2, MLED3, MLED4 Current						
LED Current Ratio (I_{MLED}/I_{RM})	$I_{MLED} = Full-Scale$	●	481	535	589	A/A
LED Dropout Voltage	Mode Switch Threshold, $I_{MLED} = Full-Scale$		75		mV	
LED Current Matching	Any Two Outputs		0.5		%	
MLED Current, 6-Bit Linear DAC	1 ENM Strobe (FS)		20		mA	
	63 ENM Strobes (FS/63)		0.318		mA	

ELECTRICAL CHARACTERISTICS

The ● denotes the specifications which apply over the full operating temperature range, otherwise specifications are at $T_A = 25^\circ\text{C}$. $V_{\text{BAT}} = 3.6\text{V}$, $C_1 = C_2 = C_3 = C_4 = 2.2\mu\text{F}$, $R_M = 30.1\text{k}$, $R_C = 24.3\text{k}$, $\text{ENM} = \text{high}$, unless otherwise noted.

PARAMETER	CONDITIONS		MIN	TYP	MAX	UNITS
Unused MLED Detection						
Test Current	MLED Tied to CPO	●	4		16	μA
Threshold Voltage	$V_{\text{CPO}} - V_{\text{MLED}}$	●	0.5		1.5	V
CLED Current						
LED Current Ratio ($I_{\text{CLED}}/I_{\text{RC}}$)	$I_{\text{CLED}} = \text{Full-Scale}$	●	6930	7700	8470	A/A
LED Dropout Voltage	Mode Switch Threshold, $I_{\text{CLED}} = \text{Full-Scale}$			500		mV
CLED Current, 3-Bit Linear DAC	1 ENC Strobe (FS)			380		mA
	7 ENC Strobes (FS/7)			54		mA
Charge Pump (CPO)						
1x Mode Output Voltage	$I_{\text{CPO}} = 0\text{mA}$			V_{BAT}		V
1.5x Mode Output Voltage	$I_{\text{CPO}} = 0\text{mA}$			4.55		V
2x Mode Output Voltage	$I_{\text{CPO}} = 0\text{mA}$			5.05		V
1x Mode Output Impedance				0.55		Ω
1.5x Mode Output Impedance	$V_{\text{BAT}} = 3.4\text{V}$, $V_{\text{CPO}} = 4.6\text{V}$ (Note 4)			3.15		Ω
2x Mode Output Impedance	$V_{\text{BAT}} = 3.2\text{V}$, $V_{\text{CPO}} = 5.1\text{V}$ (Note 4)			3.95		Ω
CLOCK Frequency				0.8		MHz
Mode Switching Delay				0.4		ms
CPO Short-Circuit Detection						
Threshold Voltage		●	0.4		1.3	V
Test Current	$\text{CPO} = 0\text{V}$, $\text{ENM} = \text{ENC} = \text{Low}$	●	10		30	mA
ENC, ENM						
V_{IL}		●			0.4	V
V_{IH}		●	1.4			V
I_{IH}	$\text{ENM} = \text{ENC} = 3.6\text{V}$	●	10	15	20	μA
I_{IL}	$\text{ENM} = \text{ENC} = 0\text{V}$	●	-1		1	μA
ENC, ENM Timing						
t_{PW}	Minimum Pulse Width	●	200			ns
t_{SD}	Low Time to Shutdown (ENC , $\text{ENM} = \text{Low}$)	●	50	150	250	μs
t_{EN}	Current Source Enable Time (ENC , $\text{ENM} = \text{High}$) (Note 5)	●	50	150	250	μs
RM, RC						
V_{RM} , V_{RC}		●	1.16	1.20	1.24	V
I_{RM} , I_{RC}		●			80	μA

Note 1: Stresses beyond those listed under Absolute Maximum Ratings may cause permanent damage to the device. Exposure to any Absolute Maximum Rating condition for extended periods may affect device reliability and lifetime.

Note 2: Based on long-term current density limitations. Assumes an operating duty cycle of $\leq 10\%$ under absolute maximum conditions for durations less than 10 seconds. Maximum current for continuous operation is 300mA.

Note 3: The LTC3210E-1 is guaranteed to meet performance specifications from 0°C to 85°C . Specifications over the -40°C to 85°C operating temperature range are assured by design, characterization and correlation with statistical process controls.

Note 4: 1.5x mode output impedance is defined as $(1.5V_{\text{BAT}} - V_{\text{CPO}})/I_{\text{OUT}}$. 2x mode output impedance is defined as $(2V_{\text{BAT}} - V_{\text{CPO}})/I_{\text{OUT}}$.

Note 5: If the part has been shut down then the initial enable time is about $100\mu\text{s}$ longer due to the bandgap enable time.

TYPICAL PERFORMANCE CHARACTERISTICS $T_A = 25^\circ\text{C}$ unless otherwise stated.

Dropout Time from Shutdown

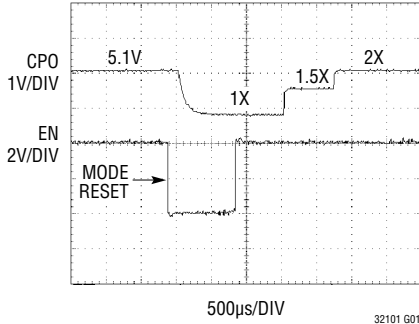

Dropout Time When Enabled

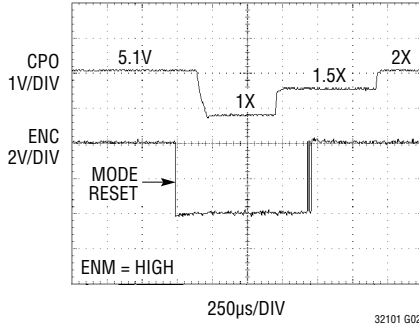

1.5x CPO Ripple

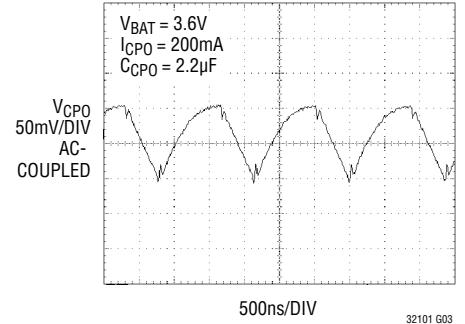

2x CPO Ripple

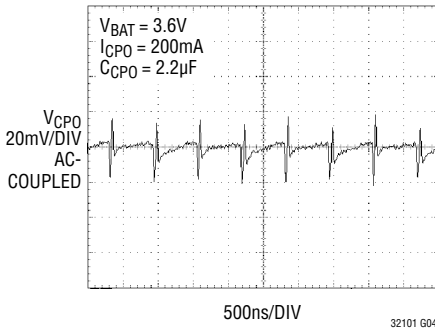

1x Mode Switch Resistance vs Temperature

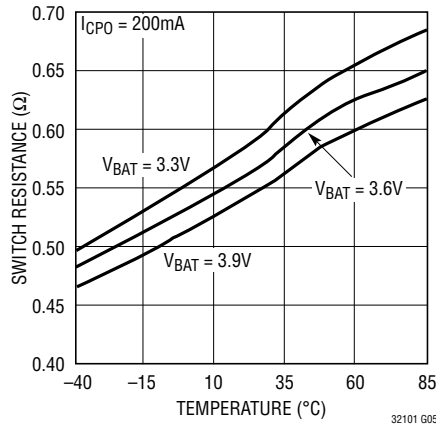

1.5x Mode Charge Pump Open-Loop Output Resistance vs Temperature $(1.5V_{BAT} - V_{CPO})/I_{CPO}$

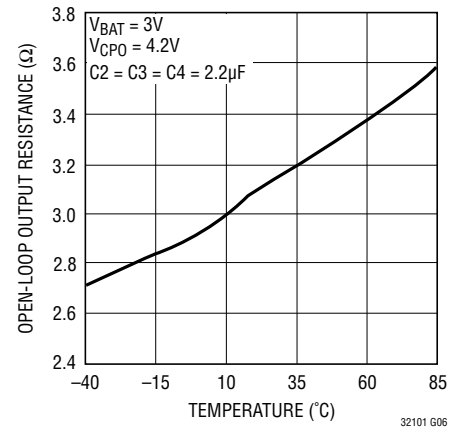

1.5x Mode CPO Voltage vs Load Current

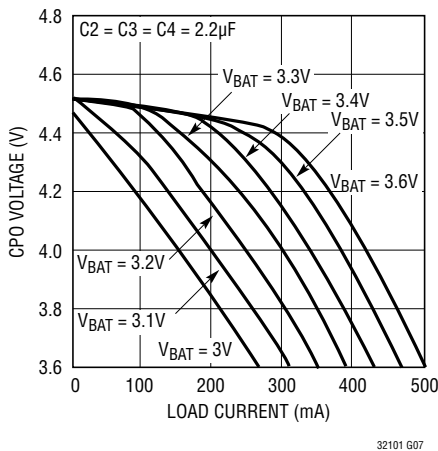

2x Mode Charge Pump Open-Loop Output Resistance vs Temperature $(2V_{BAT} - V_{CPO})/I_{CPO}$

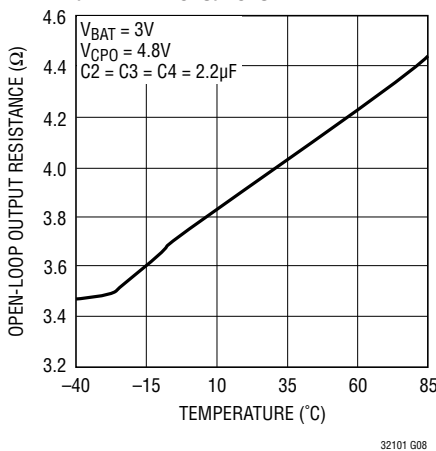

2x Mode CPO Voltage vs Load Current

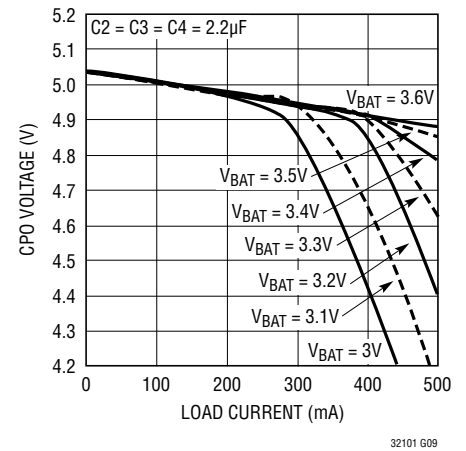

TYPICAL PERFORMANCE CHARACTERISTICS $T_A = 25^\circ\text{C}$, unless otherwise stated.

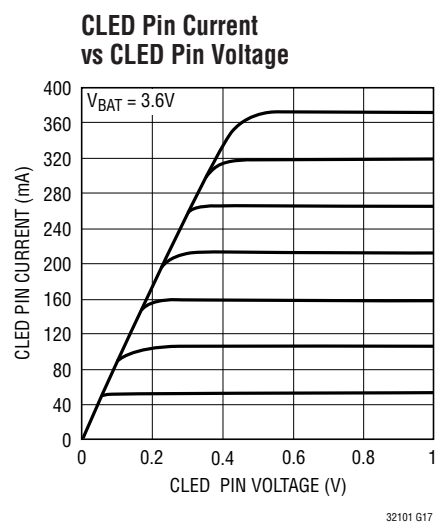
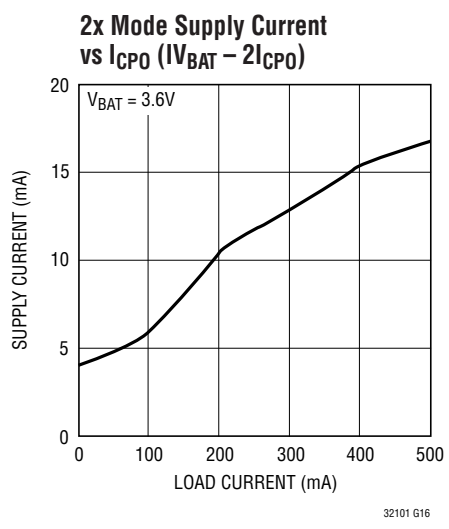
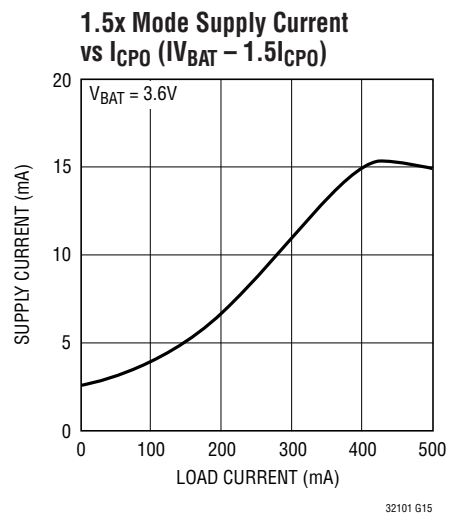
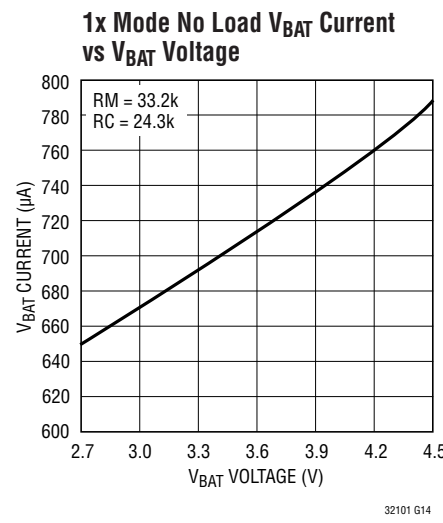
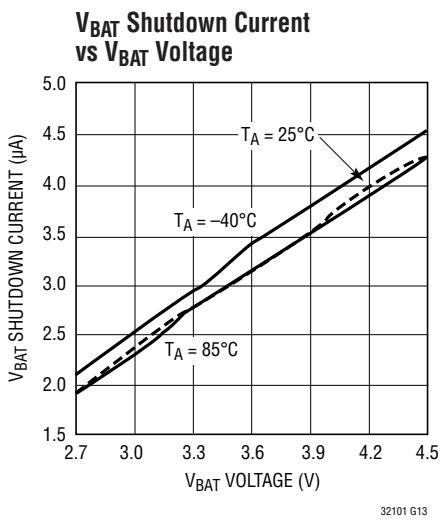
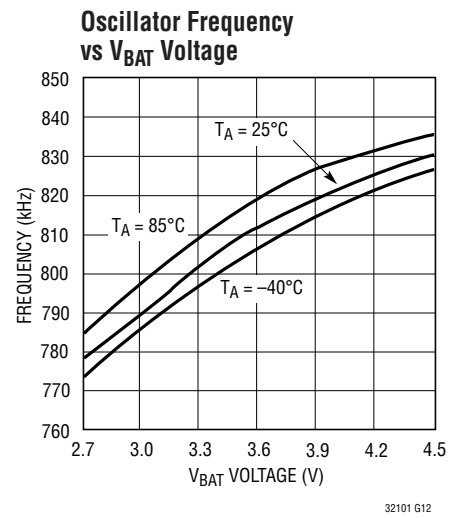
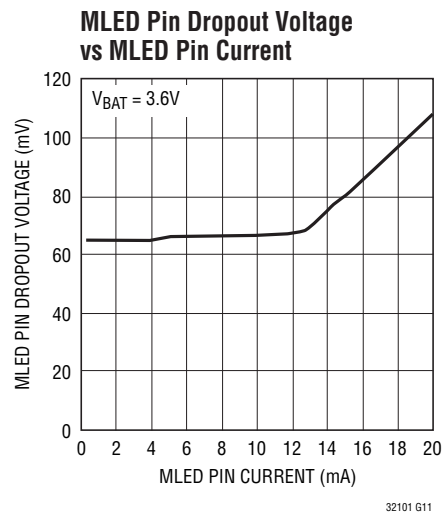
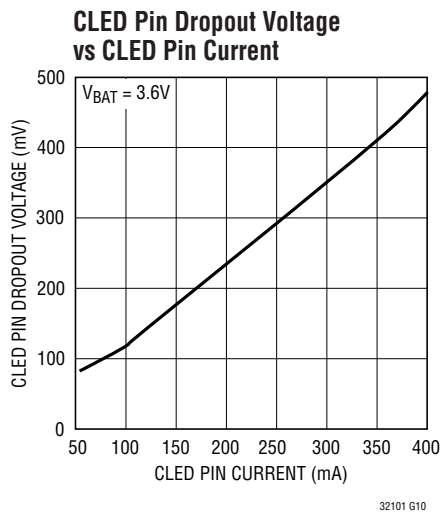

TYPICAL PERFORMANCE CHARACTERISTICS $T_A = 25^\circ\text{C}$, unless otherwise stated.

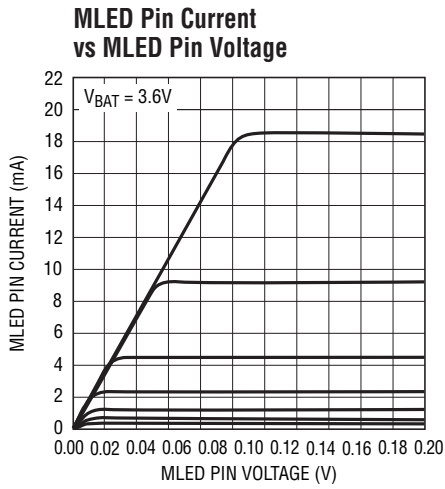

32101 G18

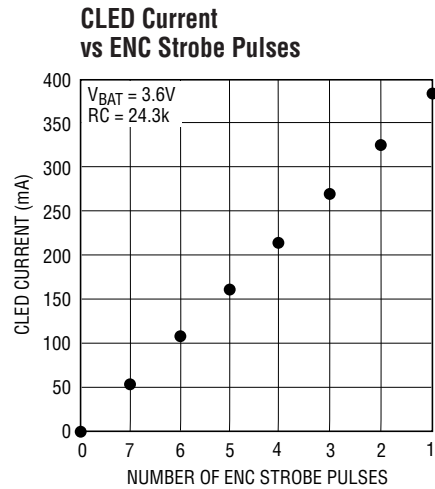

32101 G19

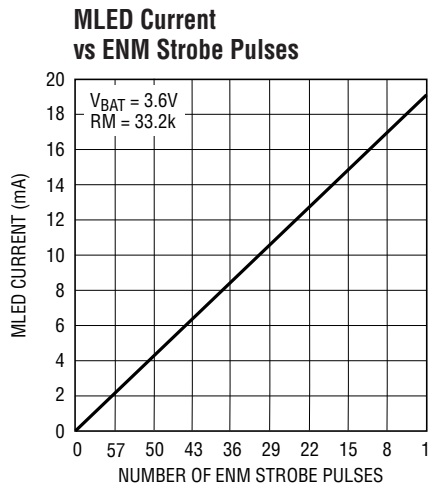

32101 G20

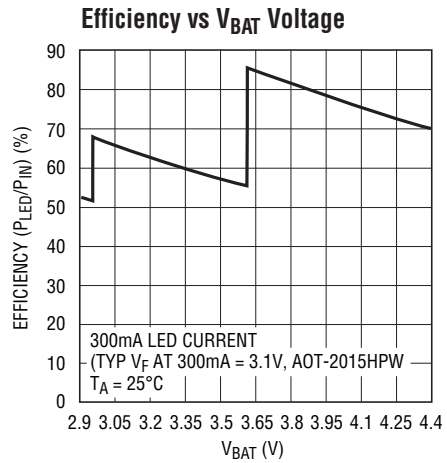

32101 G21

PIN FUNCTIONS

C1P, C2P, C1M, C2M (Pins 1, 16, 14, 13): Charge Pump Flying Capacitor Pins. A 2.2 μ F X7R or X5R ceramic capacitor should be connected from C1P to C1M and C2P to C2M.

CPO (Pin 2): Output of the Charge Pump Used to Power All LEDs. This pin is enabled or disabled using the ENM and ENC inputs. A 2.2 μ F X5R or X7R ceramic capacitor should be connected to ground.

ENM, ENC (Pins 3, 10): Inputs. The ENM and ENC pins are used to program the LED output currents. The ENC pin is strobed up to 7 times to decrement the internal 3-bit DAC's from full-scale to 1 LSB. The ENM pin is strobed 63 times to decrement the 6-bit DAC from full-scale to 1 LSB. The counters will stop at 1 LSB if the strobing continues. The pin must be held high after the final desired positive strobe edge and the data is transferred after a 150 μ s (typ) delay. Holding the ENM or ENC pin low will clear the counter for the selected display and reset the LED current to 0. If both inputs are held low for longer than 150 μ s (typ) the part will go into shutdown. The charge pump mode is reset to 1x whenever ENC goes low or when the part is shut down.

MLED1, MLED2, MLED3, MLED4 (Pins 4, 5, 6, 7): Outputs. MLED1 to MLED4 are the MAIN current source outputs. The LEDs are connected between CPO (anodes)

and MLED1-4 (cathodes). The current to each LED output is set via the ENM input, and the programming resistor connected between RM and GND. Each of the four LED outputs can be disabled by connecting the output directly to CPO. A 10 μ A current will flow through each directly connected LED output.

RM, RC (Pins 8,9): LED Current Programming Resistor Pins. The RM and RC pins will servo to 1.22V. Resistors connected between each of these pins and GND are used to set the high and low LED current levels. Connecting a resistor 12k or less will cause the LTC3210-1 to enter overcurrent shutdown.

CLED (Pin 11): Output. CLED is the CAM current source output. The LED is connected between CPO (anode) and CLED (cathode). The current to the LED output is set via the ENC input, and the programming resistor connected between RC and GND.

GND (Pin 12): Ground. This pin should be connected to a low impedance ground plane.

V_{BAT} (Pin 15): Supply voltage. This pin should be bypassed with a 2.2 μ F, or greater low ESR ceramic capacitor.

Exposed Pad (Pin 17): This pad should be connected directly to a low impedance ground plane for optimal thermal and electrical performance.

BLOCK DIAGRAM

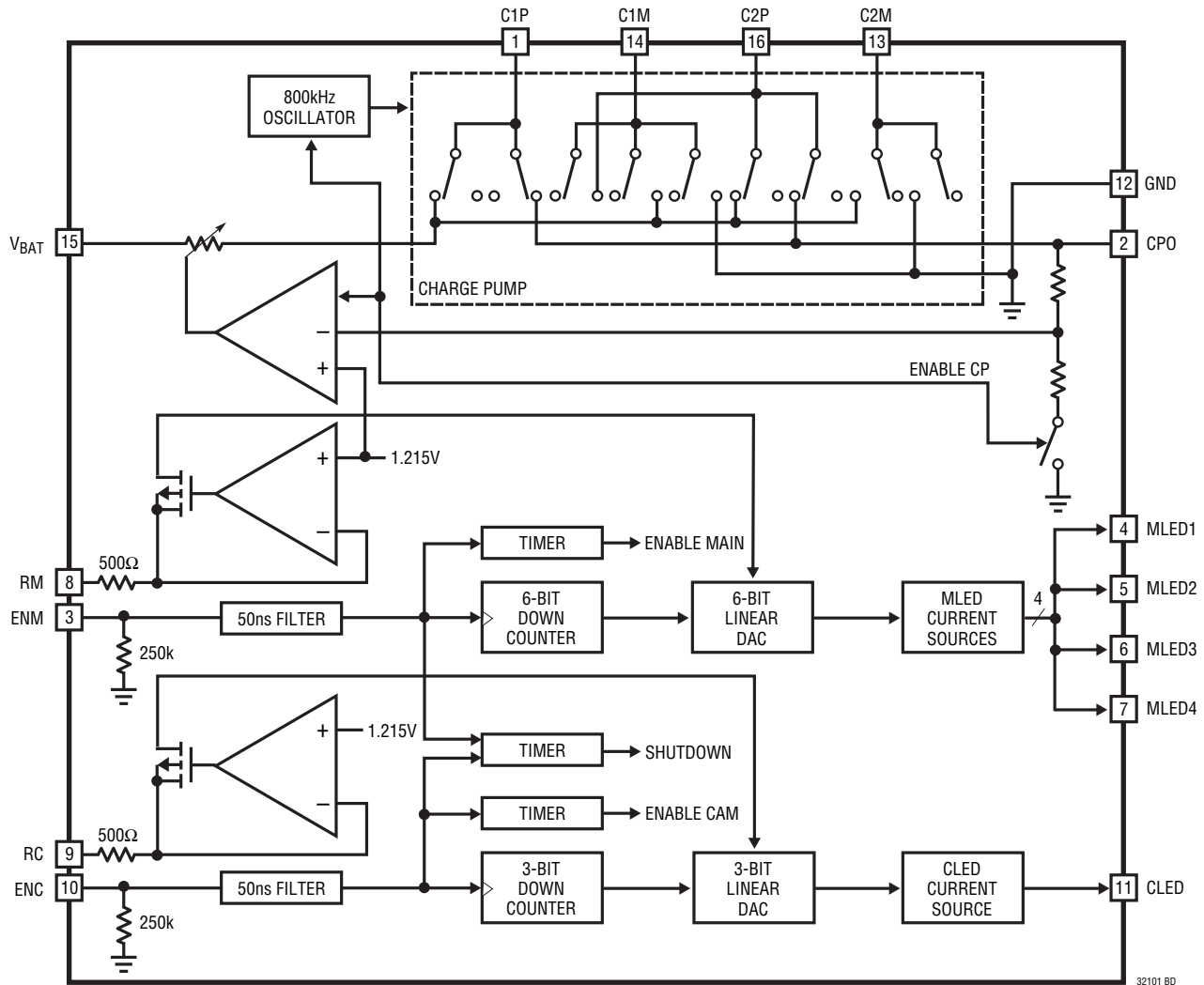

OPERATION

Power Management

The LTC3210-1 uses a switched capacitor charge pump to boost CPO to as much as 2 times the input voltage up to 5.1V. The part starts up in 1x mode. In this mode, V_{BAT} is connected directly to CPO. This mode provides maximum efficiency and minimum noise. The LTC3210-1 will remain in 1x mode until an LED current source drops out. Dropout occurs when a current source voltage becomes too low for the programmed current to be supplied. When dropout is detected, the LTC3210-1 will switch into 1.5x mode. The CPO voltage will then start to increase and will attempt to reach 1.5x V_{BAT} up to 4.6V. Any subsequent

dropout will cause the part to enter the 2x mode. The CPO voltage will attempt to reach 2x V_{BAT} up to 5.1V. The part will be reset to 1x mode whenever the part is shut down or when ENC goes low.

A two phase nonoverlapping clock activates the charge pump switches. In the 2x mode the flying capacitors are charged on alternate clock phases from V_{BAT} to minimize input current ripple and CPO voltage ripple. In 1.5x mode the flying capacitors are charged in series during the first clock phase and stacked in parallel on V_{BAT} during the second phase. This sequence of charging and discharging the flying capacitors continues at a constant frequency of 800kHz.

32101fd

OPERATION

LED Current Control

The MLED currents are delivered by the four programmable current sources. 64 linear current settings (0mA to 20mA, $R_M = 30.1k$) are available by strobing the ENM pin. Each positive strobe edge decrements a 6-bit down counter which controls a 6-bit linear DAC. When the desired current is achieved ENM is stopped high. The output current then changes to the programmed value after 150 μ s (typ). The counter will stop when the LSB is reached. The output current is set to 0 when ENM is toggled low after the output has been enabled. If strobing is started within 150 μ s (typ), after ENM has been set low, the counter will continue to count down. After 150 μ s (typ) the counter is reset.

The CLED current is delivered by a programmable current source. Eight linear current settings (0mA to 380mA, $R_C = 24.3k$) are available by strobing the ENC pin. Each positive strobe edge decrements a 3-bit down counter which controls a 3-bit linear DAC. When the desired current is reached, ENC is stopped high. The output current then changes to the programmed value after 150 μ s (typ). The counter will stop when the LSB is reached. The output current is set to 0 when ENC is toggled low after the output has been enabled. If strobing is started within 150 μ s (typ) after ENC has been set low, the counter will continue to count down. After 150 μ s (typ) the counter is reset.

The full-scale output current is calculated as follows:

$$\begin{aligned} \text{MLED full-scale output current} \\ = (1.215V / (R_M + 500)) \cdot 535 \end{aligned}$$

$$\begin{aligned} \text{CLED full-scale output current} \\ = (1.215V / (R_C + 500)) \cdot 7700 \end{aligned}$$

When both ENM and ENC are held low for more than 150 μ s (typ) the part will go into shutdown. See Figure 1 for timing information.

ENC resets the mode to 1x on a falling edge.

Soft-Start

Initially, when the part is in shutdown, a weak switch connects V_{BAT} to CPO. This allows V_{BAT} to slowly charge the CPO output capacitor to prevent large charging currents.

The LTC3210-1 also employs a soft-start feature on its charge pump to prevent excessive inrush current and supply droop when switching into the step-up modes. The current available to the CPO pin is increased linearly over a typical period of 150 μ s. Soft-start occurs at the start of both 1.5x and 2x mode changes.

Charge Pump Strength and Regulation

Regulation is achieved by sensing the voltage at the CPO pin and modulating the charge pump strength based on the error signal. The CPO regulation voltages are set internally, and are dependent on the charge pump modes, as shown in Table 1.

Table 1. Charge Pump Output Regulation Voltages

CHARGE PUMP MODE	REGULATED V_{CPO}
1.5x	4.55V
2x	5.05V

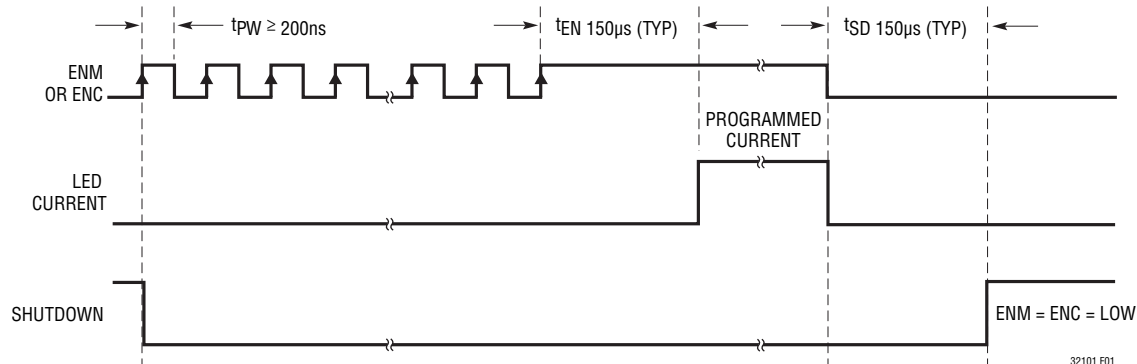

Figure 1. Current Programming Timing Diagram

OPERATION

When the LTC3210-1 operates in either 1.5x mode or 2x mode, the charge pump can be modeled as a Thevenin-equivalent circuit to determine the amount of current available from the effective input voltage and effective open-loop output resistance, R_{OL} (Figure 2).

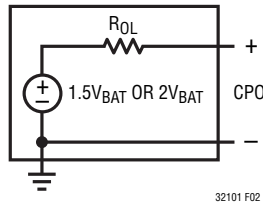

Figure 2. Charge Pump Thevenin Equivalent Open-Loop Circuit

R_{OL} is dependent on a number of factors including the switching term, $1/(2f_{OSC} \cdot C_{FLY})$, internal switch resistances and the nonoverlap period of the switching circuit. However, for a given R_{OL} , the amount of current available will be directly proportional to the advantage voltage of $1.5V_{BAT} - CPO$ for 1.5x mode and $2V_{BAT} - CPO$ for 2x mode. Consider the example of driving white LEDs from

a 3.1V supply. If the LED forward voltage is 3.8V and the current sources require 100mV, the advantage voltage for 1.5x mode is $3.1V \cdot 1.5 - 3.8V - 0.1V$ or 750mV. Notice that if the input voltage is raised to 3.2V, the advantage voltage jumps to 900mV—a 20% improvement in available strength.

From Figure 2, for 1.5x mode the available current is given by:

$$I_{OUT} = \frac{(1.5V_{BAT} - V_{CPO})}{R_{OL}}$$

For 2x mode, the available current is given by:

$$I_{OUT} = \frac{(2V_{BAT} - V_{CPO})}{R_{OL}}$$

Notice that the advantage voltage in this case is $3.1V \cdot 2 - 3.8V - 0.1V = 2.3V$. R_{OL} is higher in 2x mode but a significant overall increase in available current is achieved.

Typical values of R_{OL} as a function of temperature are shown in Figure 3 and Figure 4.

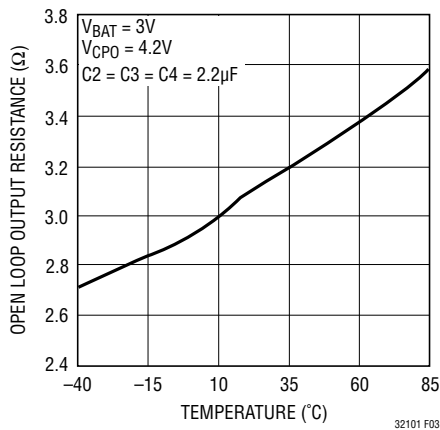

Figure 3. Typical 1.5x R_{OL} vs Temperature

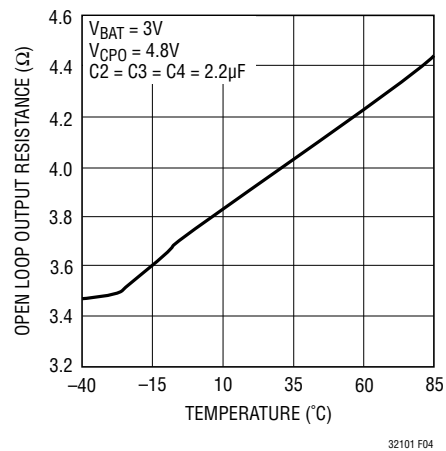

Figure 4. Typical 2x R_{OL} vs Temperature

OPERATION

Shutdown Current

In shutdown mode all the circuitry is turned off and the LTC3210-1 draws a very low current from the V_{BAT} supply. Furthermore, CPO is weakly connected to V_{BAT} . The LTC3210-1 enters shutdown mode when both the ENM and ENC pins are brought low at 150 μ s (typ). ENM and ENC have 250k internal pull down resistors to define the shutdown state when the drivers are in a high impedance state.

Thermal Protection

The LTC3210-1 has built-in overtemperature protection. At internal die temperatures of around 150°C thermal shut down will occur. This will disable all of the current sources and charge pump until the die has cooled by about 15°C. This thermal cycling will continue until the fault has been corrected.

Mode Switching

The LTC3210-1 will automatically switch from 1x mode to 1.5x mode and subsequently to 2x mode whenever a dropout condition is detected at an LED pin. Dropout occurs when a current source voltage becomes too low for the programmed current to be supplied. The time from dropout detection to mode switching is typically 0.4ms.

The part is reset back to 1x mode when the part is shut down (ENM = ENC = Low) or on the falling edge of ENC. An internal comparator will not allow the main switches to connect V_{BAT} and CPO in 1x mode until the voltage at the CPO pin has decayed to less than or equal to the voltage at the V_{BAT} pin.

APPLICATIONS INFORMATION

V_{BAT} , CPO Capacitor Selection

The style and value of the capacitors used with the LTC3210-1 determine several important parameters such as regulator control loop stability, output ripple, charge pump strength and minimum start-up time.

To reduce noise and ripple, it is recommended that low equivalent series resistance (ESR) ceramic capacitors are used for both C_{VBAT} and C_{CPO} . Tantalum and aluminum capacitors are not recommended due to high ESR.

The value of C_{CPO} directly controls the amount of output ripple for a given load current. Increasing the size of C_{CPO} will reduce output ripple at the expense of higher start-up current. The peak-to-peak output ripple of the 1.5x mode is approximately given by the expression:

$$V_{RIPPLE(P-P)} = \frac{I_{OUT}}{(3f_{OSC} \cdot C_{CPO})} \quad (3)$$

Where f_{OSC} is the LTC3210-1 oscillator frequency or typically 800kHz and C_{CPO} is the output storage capacitor.

The output ripple in 2x mode is very small due to the fact that load current is supplied on both cycles of the clock.

Both style and value of the output capacitor can significantly affect the stability of the LTC3210-1. As shown in the Block Diagram, the LTC3210-1 uses a control loop to adjust the strength of the charge pump to match the required output current. The error signal of the loop is stored directly on the output capacitor. The output capacitor also serves as the dominant pole for the control loop. To prevent ringing or instability, it is important for the output capacitor to maintain at least 1.3 μ F of capacitance over all conditions.

In addition, excessive output capacitor ESR >100m Ω will tend to degrade the loop stability. Multilayer ceramic chip capacitors typically have exceptional ESR performance and when combined with a tight board layout will result in very good stability. As the value of C_{CPO} controls the amount of output ripple, the value of C_{VBAT} controls the amount of ripple present at the input pin (V_{BAT}). The LTC3210-1's input current will be relatively constant while the charge pump is either in the input charging phase or

APPLICATIONS INFORMATION

the output charging phase but will drop to zero during the clock nonoverlap times. Since the nonoverlap time is small (~35ns), these missing “notches” will result in only a small perturbation on the input power supply line. Note that a higher ESR capacitor such as tantalum will have higher input noise due to the higher ESR. Therefore, ceramic capacitors are recommended for low ESR. Input noise can be further reduced by powering the LTC3210-1 through a very small series inductor, as shown in Figure 5. A 10nH inductor will reject the fast current notches, thereby presenting a nearly constant-current load to the input power supply. For economy, the 10nH inductor can be fabricated on the PC board with about 1cm (0.4") of PC board trace.

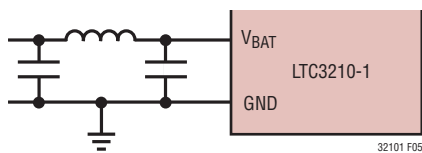

Figure 5. 10nH Inductor Used for Input Noise Reduction (Approximately 1cm of Board Trace)

Flying Capacitor Selection

Warning: Polarized capacitors such as tantalum or aluminum should never be used for the flying capacitors since their voltage can reverse upon start-up of the LTC3210-1. Ceramic capacitors should always be used for the flying capacitors.

The flying capacitors control the strength of the charge pump. In order to achieve the rated output current it is necessary to have at least 1.6 μ F of capacitance for each of the flying capacitors. Capacitors of different materials lose their capacitance with higher temperature and voltage at different rates. For example, a ceramic capacitor made of X7R material will retain most of its capacitance from -40°C to 85°C whereas a Z5U or Y5V style capacitor will lose considerable capacitance over that range. Capacitors may also have a very poor voltage coefficient causing them to lose 60% or more of their capacitance when the rated voltage is applied. Therefore, when comparing different capacitors, it is often more appropriate to compare the amount of achievable capacitance for a given case size rather than comparing the specified capacitance value. For

example, over rated voltage and temperature conditions, a 1 μ F, 10V, Y5V ceramic capacitor in a 0603 case may not provide any more capacitance than a 0.22 μ F, 10V, X7R available in the same case. The capacitor manufacturer's data sheet should be consulted to determine what value of capacitor is needed to ensure minimum capacitances at all temperatures and voltages.

Table 2 shows a list of ceramic capacitor manufacturers and how to contact them:

Table 2. Recommended Capacitor Vendors

AVX	www.avxcorp.com
Kemet	www.kemet.com
Murata	www.murata.com
Taiyo Yuden	www.t-yuden.com
Vishay	www.vishay.com

Layout Considerations and Noise

Due to the high switching frequency and the transient currents produced by the LTC3210-1, careful board layout is necessary. A true ground plane and short connections to all capacitors will improve performance and ensure proper regulation under all conditions.

The flying capacitor pins C1P, C2P, C1M and C2M will have high edge rate waveforms. The large dv/dt on these pins can couple energy capacitively to adjacent PCB runs. Magnetic fields can also be generated if the flying capacitors are not close to the LTC3210-1 (i.e., the loop area is large). To decouple capacitive energy transfer, a Faraday shield may be used. This is a grounded PCB trace between the sensitive node and the LTC3210-1 pins. For a high quality AC ground, it should be returned to a solid ground plane that extends all the way to the LTC3210-1.

The following guidelines should be followed when designing a PCB layout for the LTC3210-1:

- The exposed pad should be soldered to a large copper plane that is connected to a solid, low impedance ground plane using plated through-hole vias for proper heat sinking and noise protection.
- Input and output capacitors must be placed close to the part.

APPLICATIONS INFORMATION

- The flying capacitors must be placed close to the part. The traces from the pins to the capacitor pad should be as wide as possible.
- V_{BAT} , CPO traces must be wide to minimize inductance and handle high currents.
- LED pads must be large and connected to other layers of metal to ensure proper heat sinking.
- RM and RC pins are sensitive to noise and capacitance. The resistors should be placed near the part with minimum line width.

Power Efficiency

To calculate the power efficiency (η) of a white LED driver chip, the LED power should be compared to the input power. The difference between these two numbers represents lost power whether it is in the charge pump or the current sources. Stated mathematically, the power efficiency is given by:

$$\eta = \frac{P_{LED}}{P_{IN}}$$

The efficiency of the LTC3210-1 depends upon the mode in which it is operating. Recall that the LTC3210-1 operates as a pass switch, connecting V_{BAT} to CPO, until dropout is detected at the LED pin. This feature provides the optimum efficiency available for a given input voltage and LED forward voltage. When it is operating as a switch, the efficiency is approximated by:

$$\eta = \frac{P_{LED}}{P_{IN}} = \frac{(V_{LED} \cdot I_{LED})}{(V_{BAT} \cdot I_{BAT})} = \frac{V_{LED}}{V_{BAT}}$$

since the input current will be very close to the sum of the LED currents.

At moderate to high output power, the quiescent current of the LTC3210-1 is negligible and the expression above is valid.

Once dropout is detected at any LED pin, the LTC3210-1 enables the charge pump in 1.5x mode.

In 1.5x boost mode, the efficiency is similar to that of a linear regulator with an effective input voltage of 1.5 times the actual input voltage. This is because the input current for a 1.5x charge pump is approximately 1.5 times the load current. In an ideal 1.5x charge pump, the power efficiency would be given by:

$$\eta_{IDEAL} = \frac{P_{LED}}{P_{IN}} = \frac{(V_{LED} \cdot I_{LED})}{(V_{BAT} \cdot (1.5) \cdot I_{LED})} = \frac{V_{LED}}{(1.5 \cdot V_{BAT})}$$

Similarly, in 2x boost mode, the efficiency is similar to that of a linear regulator with an effective input voltage of 2 times the actual input voltage. In an ideal 2x charge pump, the power efficiency would be given by:

$$\eta_{IDEAL} = \frac{P_{LED}}{P_{IN}} = \frac{(V_{LED} \cdot I_{LED})}{(V_{BAT} \cdot (2) \cdot I_{LED})} = \frac{V_{LED}}{(2 \cdot V_{BAT})}$$

Thermal Management

For higher input voltages and maximum output current, there can be substantial power dissipation in the LTC3210-1. If the junction temperature increases above approximately 150°C the thermal shut down circuitry will automatically deactivate the output current sources and charge pump. To reduce maximum junction temperature, a good thermal connection to the PC board is recommended. Connecting the exposed pad to a ground plane and maintaining a solid ground plane under the device will reduce the thermal resistance of the package and PC board considerably.

PACKAGE DESCRIPTION

UD Package
16-Lead Plastic QFN (3mm × 3mm)
 (Reference LTC DWG # 05-08-1691)

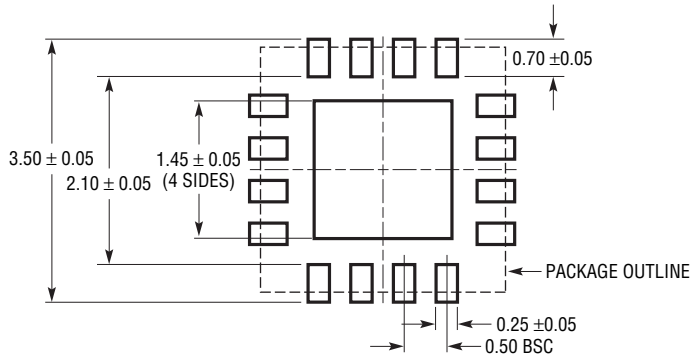

RECOMMENDED SOLDER PAD PITCH AND DIMENSIONS

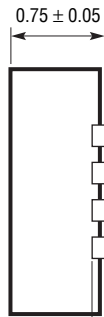
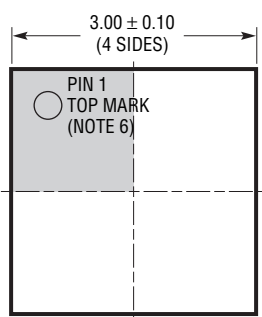

BOTTOM VIEW—EXPOSED PAD

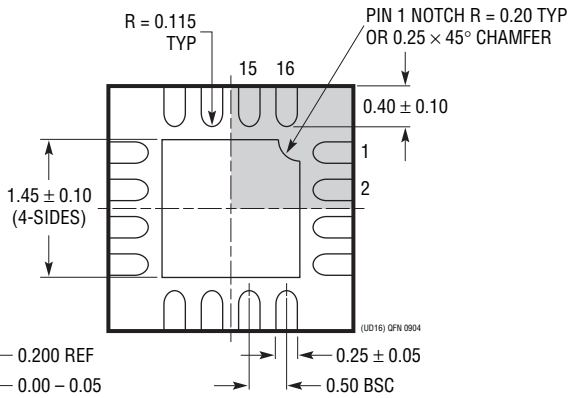

- NOTE:
1. DRAWING CONFORMS TO JEDEC PACKAGE OUTLINE MO-220 VARIATION (WEED-2)
 2. DRAWING NOT TO SCALE
 3. ALL DIMENSIONS ARE IN MILLIMETERS
 4. DIMENSIONS OF EXPOSED PAD ON BOTTOM OF PACKAGE DO NOT INCLUDE MOLD FLASH. MOLD FLASH, IF PRESENT, SHALL NOT EXCEED 0.15mm ON ANY SIDE
 5. EXPOSED PAD SHALL BE SOLDER PLATED
 6. SHADED AREA IS ONLY A REFERENCE FOR PIN 1 LOCATION ON THE TOP AND BOTTOM OF PACKAGE

REVISION HISTORY (Revision history begins at Rev D)

REV	DATE	DESCRIPTION	PAGE NUMBER
D	6/10	Removal of PDC package information from data sheet. LTC3210EPD-1 designated obsolete in Order Information section.	1 to 16 2