

LTC3859A

ABSOLUTE MAXIMUM RATINGS (Notes 1, 3)

Bias Input Supply Voltage (V_{BIAS}).....	-0.3V to 40V
Buck Top Side Driver Voltages (BOOST1, BOOST2)	-0.3V to 46V
Boost Top Side Driver Voltages (BOOST3)	-0.3V to 76V
Buck Switch Voltage (SW1, SW2)	-5V to 40V
Boost Switch Voltage (SW3)	-5V to 70V
INTV _{CC} , (BOOST1-SW1), (BOOST2-SW2), (BOOST3-SW3),.....	-0.3V to 6V
RUN1, RUN2, RUN3	-0.3V to 8V
Maximum Current Sourced Into Pin from Source >8V	100 μ A

SENSE1 ⁺ , SENSE2 ⁺ , SENSE1 ⁻ SENSE2 ⁻ Voltages	-0.3V to 28V
SENSE3 ⁺ , SENSE3 ⁻ Voltages.....	-0.3V to 40V
FREQ Voltages	-0.3V to INTV _{CC}
EXTV _{CC}	-0.3V to 14V
I _{TH1} , I _{TH2} , I _{TH3} , V _{FB1} , V _{FB2} , V _{FB3} Voltages....	-0.3V to 6V
PLLIN/MODE, PGOOD1, OV3 Voltages	-0.3V to 6V
TRACK/SS1, TRACK/SS2, SS3 Voltages	-0.3V to 6V
Operating Junction Temperature Range (Note 2)	
LTC3859AE, LTC3859AI.....	-40°C to 125°C
LTC3859AH.....	-40°C to 150°C
LTC3859AMP.....	-55°C to 150°C
Storage Temperature Range	-65°C to 150°C

PIN CONFIGURATION

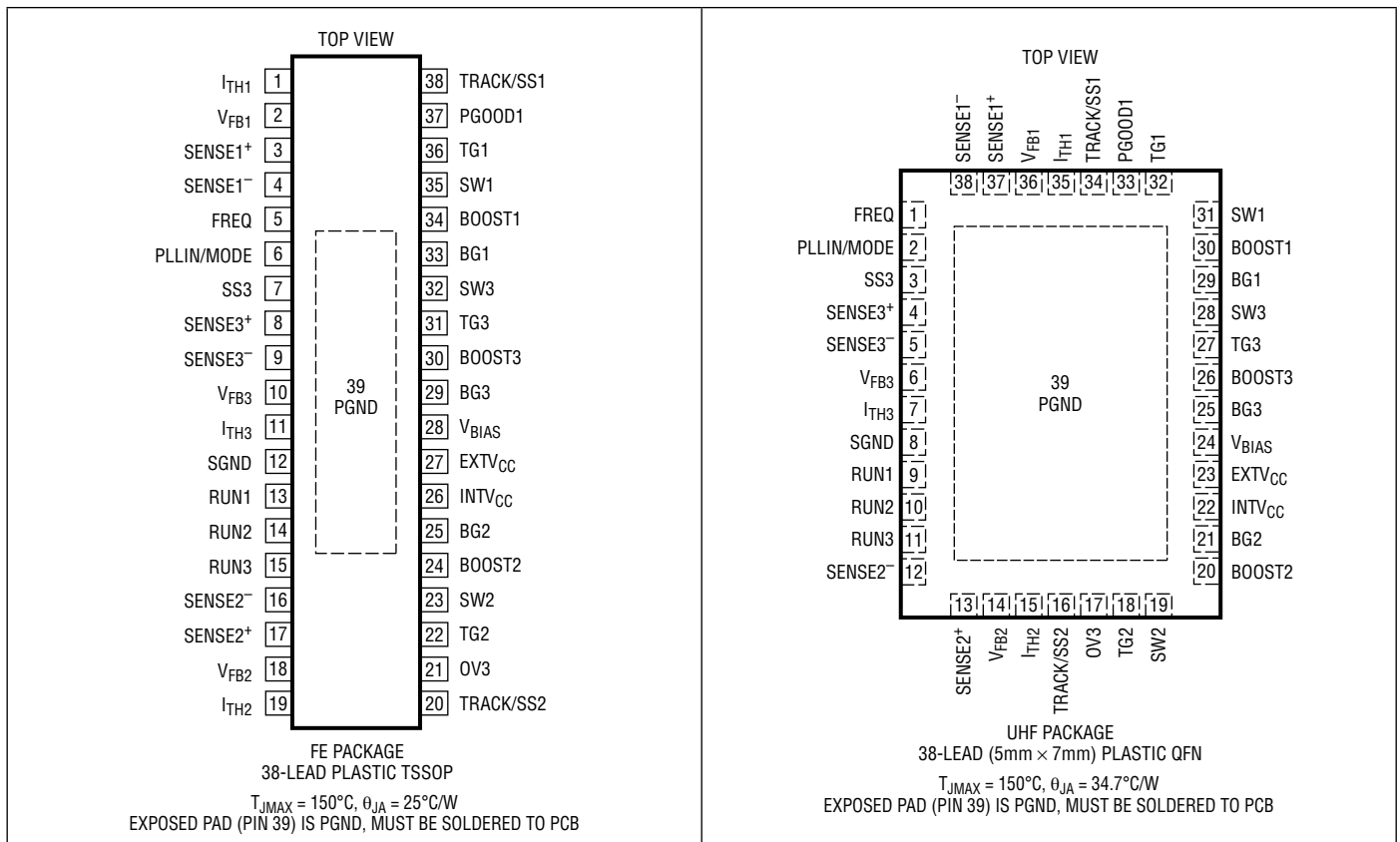

ORDER INFORMATION

LEAD FREE FINISH	TAPE AND REEL	PART MARKING*	PACKAGE DESCRIPTION	TEMPERATURE RANGE
LTC3859AEFE#PBF	LTC3859AEFE#TRPBF	LTC3859AFE	38-Lead Plastic TSSOP	-40°C to 125°C
LTC3859AIFE#PBF	LTC3859AIFE#TRPBF	LTC3859AFE	38-Lead Plastic TSSOP	-40°C to 125°C
LTC3859AHFE#PBF	LTC3859AHFE#TRPBF	LTC3859AFE	38-Lead Plastic TSSOP	-40°C to 150°C
LTC3859AMPFE#PBF	LTC3859AMPFE#TRPBF	LTC3859AFE	38-Lead Plastic TSSOP	-55°C to 150°C
LTC3859AEUHF#PBF	LTC3859AEUHF#TRPBF	3859A	38-Lead (5mm × 7mm) Plastic QFN	-40°C to 125°C
LTC3859AIUHF#PBF	LTC3859AIUHF#TRPBF	3859A	38-Lead (5mm × 7mm) Plastic QFN	-40°C to 125°C
LTC3859AHUHF#PBF	LTC3859AHUHF#TRPBF	3859A	38-Lead (5mm × 7mm) Plastic QFN	-40°C to 150°C
LTC3859AMPUHF#PBF	LTC3859AMPUHF#TRPBF	3859A	38-Lead (5mm × 7mm) Plastic QFN	-55°C to 150°C

Contact the factory for parts specified with wider operating temperature ranges. *The temperature grade is identified by a label on the shipping container.

[Tape and reel specifications](#). Some packages are available in 500 unit reels through designated sales channels with #TRMPBF suffix.

ELECTRICAL CHARACTERISTICS The ● denotes the specifications which apply over the specified operating junction temperature range, otherwise specifications are at $T_A = 25^\circ\text{C}$. $V_{\text{BIAS}} = 12\text{V}$, $V_{\text{RUN}1,2,3} = 5\text{V}$, $\text{EXTV}_{\text{CC}} = 0\text{V}$ unless otherwise noted. (Note 2)

SYMBOL	PARAMETER	CONDITIONS	MIN	TYP	MAX	UNITS
V_{BIAS}	Bias Input Supply Operating Voltage Range		4.5		38	V
$V_{\text{FB}1,2}$	Buck Regulated Feedback Voltage	(Note 4); $I_{\text{TH}1,2}$ Voltage = 1.2V -40°C to 85°C, All Grades LTC3859AE, LTC3859AI ● LTC3859AH, LTC3859AMP ●	0.792	0.800	0.808	V
$V_{\text{FB}3}$	Boost Regulated Feedback Voltage	(Note 4); $I_{\text{TH}3}$ Voltage = 1.2V -40°C to 85°C, All Grades LTC3859AE, LTC3859AI ● LTC3859AH, LTC3859AMP ●	1.188	1.200	1.212	V
$I_{\text{FB}1,2,3}$	Feedback Current	(Note 4)		-10	±50	nA
V_{REFLNREG}	Reference Voltage Line Regulation	(Note 4); $V_{\text{BIAS}} = 4.5\text{V}$ to 38V		0.002	0.02	%/V
V_{LOADREG}	Output Voltage Load Regulation	(Note 4)				
		Measured in Servo Loop; ΔI_{TH} Voltage = 1.2V to 0.7V ●		0.01	0.1	%
		Measured in Servo Loop; ΔI_{TH} Voltage = 1.2V to 2V ●		-0.01	-0.1	%
$g_{\text{m}1,2,3}$	Transconductance Amplifier g_{m}	(Note 4); $I_{\text{TH}1,2,3} = 1.2\text{V}$; Sink/Source 5 μA		2		mmho

ELECTRICAL CHARACTERISTICS

The ● denotes the specifications which apply over the specified operating junction temperature range, otherwise specifications are at $T_A = 25^\circ\text{C}$. $V_{BIAS} = 12\text{V}$, $V_{RUN1,2,3} = 5\text{V}$, $EXTV_{CC} = 0\text{V}$ unless otherwise noted. (Note 2)

SYMBOL	PARAMETER	CONDITIONS	MIN	TYP	MAX	UNITS	
I_Q	Input DC Supply Current	(Note 5)					
	Pulse-Skipping or Forced Continuous Mode (One Channel On)	RUN1 = 5V and RUN2,3 = 0V or RUN2 = 5V and RUN1,3 = 0V or RUN3 = 5V and RUN1,2 = 0V $V_{FB1,2\text{ ON}} = 0.83\text{V}$ (No Load) $V_{FB3} = 1.25\text{V}$		1.5		mA	
	Pulse-Skipping or Forced Continuous Mode (All Channels On)	RUN1,2,3 = 5V, $V_{FB1,2} = 0.83\text{V}$ (No Load) $V_{FB3} = 1.25\text{V}$		3		mA	
	Sleep Mode (One Channel On, Buck)	RUN1 = 5V and RUN2,3 = 0V or RUN2 = 5V and RUN1,3 = 0V $V_{FB,ON} = 0.83\text{V}$ (No Load)		55	80	μA	
	Sleep Mode (One Channel On, Boost)	RUN3 = 5V and RUN1,2 = 0V $V_{FB3} = 1.25\text{V}$		55	80	μA	
	Sleep Mode (Buck and Boost Channel On)	RUN1 = 5V and RUN2 = 0V or RUN2 = 5V and RUN1 = 0V RUN3 = 5V $V_{FB1,2} = 0.83\text{V}$ (No Load) $V_{FB3} = 1.25\text{V}$		65	100	μA	
	Sleep Mode (All Three Channels On)	RUN1,2,3 = 5V, $V_{FB1,2} = 0.83\text{V}$ (No Load) $V_{FB3} = 1.25\text{V}$		80	120	μA	
	Shutdown	RUN1,2,3 = 0V		14	30	μA	
UVLO	Undervoltage Lockout	INTV _{CC} Ramping Up	●	4.15	4.5	V	
		INTV _{CC} Ramping Down	●	3.5	3.8	4.0	V
$V_{OVL1,2}$	Buck Feedback Overvoltage Protection	Measured at $V_{FB1,2}$ Relative to Regulated $V_{FB1,2}$		7	10	13	%
$I_{SENSE1,2+}$	SENSE ⁺ Pin Current	Bucks (Channels 1 and 2)			± 1	μA	
$I_{SENSE3+}$	SENSE ⁺ Pin Current	Boost (Channel 3)		170		μA	
$I_{SENSE1,2-}$	SENSE ⁻ Pin Current	Bucks (Channels 1 and 2) $V_{OUT1,2} < V_{INTVCC} - 0.5\text{V}$ $V_{OUT1,2} > V_{INTVCC} + 0.5\text{V}$			± 2	μA	
				700		μA	
$I_{SENSE3-}$	SENSE ⁻ Pin Current	Boost (Channel 3) $V_{SENSE3+}, V_{SENSE3-} = 12\text{V}$			± 1	μA	
$DF_{MAX,TG}$	Maximum Duty Factor for TG	Bucks (Channels 1,2) in Dropout, FREQ = 0V	98	99		%	
		Boost (Channel 3) in Overvoltage		100		%	
$DF_{MAX,BG}$	Maximum Duty Factor for BG	Bucks (Channels 1,2) in Overvoltage		100		%	
		Boost (Channel 3)		96		%	
$I_{TRACK/SS1,2}$	Soft-Start Charge Current	$V_{TRACK/SS1,2} = 0\text{V}$	0.7	1.0	1.4	μA	
I_{SS3}	Soft-Start Charge Current	$V_{SS3} = 0\text{V}$	0.7	1.0	1.4	μA	
$V_{RUN1\text{ ON}}$ $V_{RUN2,3\text{ ON}}$	RUN1 Pin Threshold	V_{RUN1} Rising	●	1.19	1.25	1.31	V
	RUN2,3 Pin Threshold	$V_{RUN2,3}$ Rising	●	1.23	1.28	1.33	V
$V_{RUN1,2,3\text{ Hyst}}$	RUN Pin Hysteresis			80		mV	
$V_{SENSE1,2,3(MAX)}$	Maximum Current Sense Threshold	$V_{FB1,2} = 0.7\text{V}$, $V_{SENSE1,2-} = 3.3\text{V}$ $V_{FB1,2,3} = 1.1\text{V}$, $V_{SENSE3+} = 12\text{V}$	●	43	50	57	mV
$V_{SENSE3(CM)}$	SENSE3 Pins Common Mode Range (BOOST Converter Input Supply Voltage)			2.5	38	V	

ELECTRICAL CHARACTERISTICS

The ● denotes the specifications which apply over the specified operating junction temperature range, otherwise specifications are at $T_A = 25^\circ\text{C}$. $V_{\text{BIAS}} = 12\text{V}$, $V_{\text{RUN}1,2,3} = 5\text{V}$, $\text{EXTV}_{\text{CC}} = 0\text{V}$ unless otherwise noted. (Note 2)

SYMBOL	PARAMETER	CONDITIONS	MIN	TYP	MAX	UNITS	
Gate Driver							
TG1,2	Pull-Up On-Resistance			2.5		Ω	
	Pull-Down On-Resistance			1.5		Ω	
BG1,2	Pull-Up On-Resistance			2.4		Ω	
	Pull-Down On-Resistance			1.1		Ω	
TG3	Pull-Up On-Resistance			1.2		Ω	
	Pull-Down On-Resistance			1.0		Ω	
BG3	Pull-Up On-Resistance			1.2		Ω	
	Pull-Down On-Resistance			1.0		Ω	
TG1,2,3 t_r	TG Transition Time: Rise Time	(Note 6) $C_{\text{LOAD}} = 3300\text{pF}$		25		ns	
	TG1,2,3 t_f	Fall Time $C_{\text{LOAD}} = 3300\text{pF}$		16		ns	
BG1,2,3 t_r	BG Transition Time: Rise Time	(Note 6) $C_{\text{LOAD}} = 3300\text{pF}$		28		ns	
	BG1,2,3 t_f	Fall Time $C_{\text{LOAD}} = 3300\text{pF}$		13		ns	
TG/BG t_{1D}	Top Gate Off to Bottom Gate On Delay	$C_{\text{LOAD}} = 3300\text{pF}$ Each Driver	Bucks (Channels 1, 2) Boost (Channel 3)	30		ns	
	Synchronous Switch-On Delay Time			70		ns	
BG/TG t_{1D}	Bottom Gate Off to Top Gate On Delay	$C_{\text{LOAD}} = 3300\text{pF}$ Each Driver	Bucks (Channels 1, 2) Boost (Channel 3)	30		ns	
	Top Switch-On Delay Time			70		ns	
$t_{\text{ON(MIN)1,2}}$	Buck Minimum On-Time	(Note 7)		95		ns	
$t_{\text{ON(MIN)3}}$	Boost Minimum On-Time	(Note 7)		120		ns	
INTV_{CC} Linear Regulator							
$V_{\text{INTVCCBIAS}}$	Internal V_{CC} Voltage	$6\text{V} < V_{\text{BIAS}} < 38\text{V}$, $V_{\text{EXTVCC}} = 0\text{V}$, $I_{\text{INTVCC}} = 0\text{mA}$	5.0	5.4	5.6	V	
V_{LDOVBIAS}	INTV _{CC} Load Regulation	$I_{\text{CC}} = 0\text{mA}$ to 50mA , $V_{\text{EXTVCC}} = 0\text{V}$		0.7	2	%	
$V_{\text{INTVCCEXT}}$	Internal V_{CC} Voltage	$6\text{V} < V_{\text{EXTVCC}} < 13\text{V}$, $I_{\text{INTVCC}} = 0\text{mA}$	5.0	5.4	5.6	V	
V_{LDOEXT}	INTV _{CC} Load Regulation	$I_{\text{CC}} = 0\text{mA}$ to 50mA , $V_{\text{EXTVCC}} = 8.5\text{V}$		0.7	2	%	
V_{EXTVCC}	EXTV _{CC} Switchover Voltage	EXTV _{CC} Ramping Positive	4.5	4.7		V	
V_{LDOHYS}	EXTV _{CC} Hysteresis			200		mV	
Oscillator and Phase-Locked Loop							
f_{25k}	Programmable Frequency	$R_{\text{FREQ}} = 25k$; PLLIN/MODE = DC Voltage		115		kHz	
f_{65k}	Programmable Frequency	$R_{\text{FREQ}} = 65k$; PLLIN/MODE = DC Voltage	375	440	505	kHz	
f_{105k}	Programmable Frequency	$R_{\text{FREQ}} = 105k$; PLLIN/MODE = DC Voltage		835		kHz	
f_{LOW}	Low Fixed Frequency	$V_{\text{FREQ}} = 0\text{V}$ PLLIN/MODE = DC Voltage	320	350	380	kHz	
f_{HIGH}	High Fixed Frequency	$V_{\text{FREQ}} = \text{INTV}_{\text{CC}}$; PLLIN/MODE = DC Voltage	485	535	585	kHz	
f_{SYNC}	Synchronizable Frequency	PLLIN/MODE = External Clock	●	75	850	kHz	
PGOOD1 Output							
V_{PGL1}	PGOOD1 Voltage Low	$I_{\text{PGOOD1}} = 2\text{mA}$		0.2	0.4	V	
I_{PGOOD1}	PGOOD1 Leakage Current	$V_{\text{PGOOD1}} = 5\text{V}$			± 1	μA	
V_{PG1}	PGOOD1 Trip Level	V_{FB1} with Respect to Set Regulated Voltage		-13	-10	-7	%
		V_{FB1} Ramping Negative					%
		Hysteresis			2.5		%
		V_{FB1} Ramping Positive		7	10	13	%
		Hysteresis			2.5	%	

ELECTRICAL CHARACTERISTICS

The ● denotes the specifications which apply over the specified operating junction temperature range, otherwise specifications are at $T_A = 25^\circ\text{C}$. $V_{\text{BIAS}} = 12\text{V}$, $V_{\text{RUN}1,2,3} = 5\text{V}$, $\text{EXTV}_{\text{CC}} = 0\text{V}$ unless otherwise noted. (Note 2)

SYMBOL	PARAMETER	CONDITIONS	MIN	TYP	MAX	UNITS
T_{PG1}	Delay For Reporting a Fault			20		μs
OV3 Boost Overvoltage Indicator Output						
V_{OV3L}	OV3 Voltage Low	$I_{\text{OV3}} = 2\text{mA}$		0.2	0.4	V
I_{OV3}	OV3 Leakage Current	$V_{\text{OV3}} = 5\text{V}$			± 1	μA
V_{OV}	OV3 Trip Level	V_{FB} With Respect to Set Regulated Voltage	6	10	13	%
		Hysteresis		1.5		%
BOOST3 Charge Pump						
I_{BST3}	BOOST3 Charge Pump Available Output Current	$V_{\text{BOOST3}} = 16\text{V}$; $V_{\text{SW3}} = 12\text{V}$; Forced Continuous Mode		65		μA

Note 1: Stresses beyond those listed under Absolute Maximum Ratings may cause permanent damage to the device. Exposure to any Absolute Maximum Rating condition for extended periods may affect device reliability and lifetime.

Note 2: The LTC3859A is tested under pulsed load conditions such that $T_J \approx T_A$. The LTC3859AE is guaranteed to meet performance specifications from 0°C to 85°C . Specifications over the -40°C to 125°C operating junction temperature range are assured by design, characterization and correlation with statistical process controls. The LTC3859AI is guaranteed over the -40°C to 125°C operating junction temperature range, the LTC3859AH is guaranteed over the -40°C to 150°C operating junction temperature range and the LTC3859AMP is tested and guaranteed over the -55°C to 150°C operating junction temperature range. High junction temperatures degrade operating lifetimes; operating lifetime is derated for junction temperatures greater than 125°C . Note that the maximum ambient temperature consistent with these specifications is determined by specific operating conditions in conjunction with board layout, the rated package thermal impedance and other environmental factors. T_J is calculated from the ambient temperature T_A and power dissipation P_D according to the following formula: $T_J = T_A + (P_D \cdot \theta_{JA})$, where $\theta_{JA} = 34^\circ\text{C}/\text{W}$ for the QFN package and $\theta_{JA} = 25^\circ\text{C}/\text{W}$ for the TSSOP package.

Note 3: This IC includes overtemperature protection that is intended to protect the device during momentary overload conditions. The maximum rated junction temperature will be exceeded when this protection is active. Continuous operation above the specified absolute maximum operating junction temperature may impair device reliability or permanently damage the device.

Note 4: The LTC3859A is tested in a feedback loop that servos $V_{\text{ITH}1,2,3}$ to a specified voltage and measures the resultant V_{FB} . The specification at 85°C is not tested in production and is assured by design, characterization and correlation to production testing at other temperatures (125°C for the LTC3859AE/LTC3859AI, 150°C for the LTC3859AH/LTC3859AMP). For the LTC3859AMP, the specification at -40°C is not tested in production and is assured by design, characterization and correlation to production testing at -55°C .

Note 5: Dynamic supply current is higher due to the gate charge being delivered at the switching frequency. See the Applications Information section.

Note 6: Rise and fall times are measured using 10% and 90% levels. Delay times are measured using 50% levels.

Note 7: The minimum on-time condition is specified for an inductor peak-to-peak ripple current $\geq 40\%$ of I_{MAX} (See the Minimum On-Time Considerations in the Applications Information section).

TYPICAL PERFORMANCE CHARACTERISTICS

Efficiency and Power Loss vs Output Current (Buck)

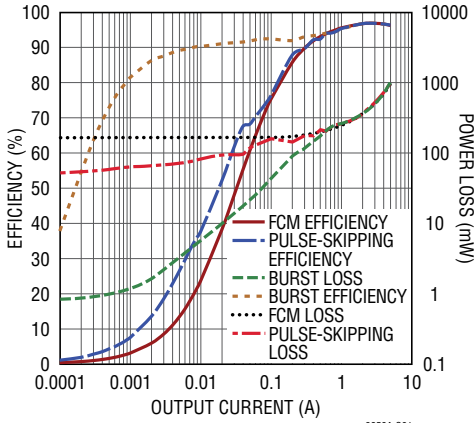

FIGURE 12 CIRCUIT
VIN = 10V, VOUT = 5V

3859A G01

Efficiency vs Output Current (Buck)

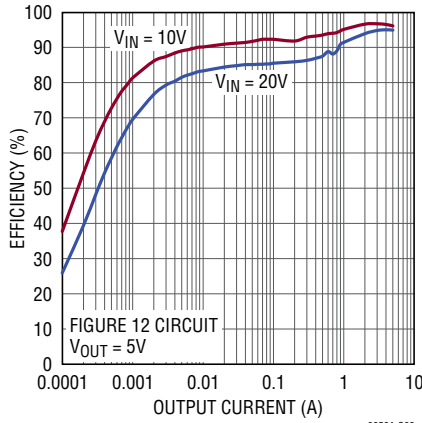

FIGURE 12 CIRCUIT
VOUT = 5V

3859A G02

Efficiency vs Input Voltage (Buck)

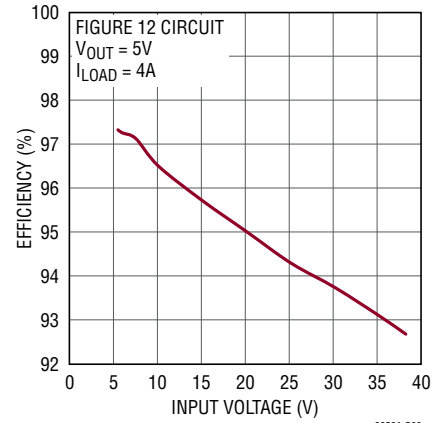
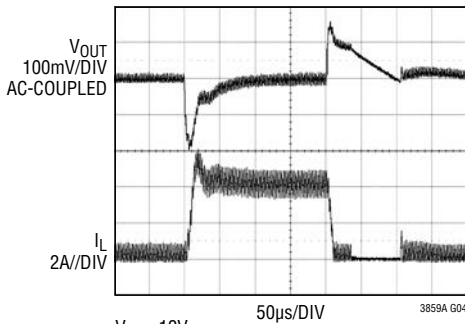

FIGURE 12 CIRCUIT
VOUT = 5V
ILOAD = 4A

3859A G03

Load Step (Buck) Burst Mode Operation



VIN = 12V
VOUT = 5V
FIGURE 12 CIRCUIT

3859A G04

Load Step (Buck) Pulse-Skipping Mode

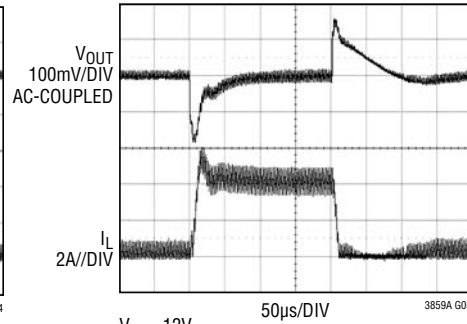

VIN = 12V
VOUT = 5V
FIGURE 12 CIRCUIT

3859A G05

Load Step (Buck) Forced Continuous Mode

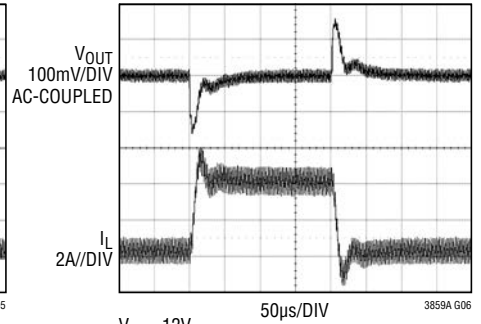

VIN = 12V
VOUT = 5V
FIGURE 12 CIRCUIT

3859A G06

Inductor Current at Light Load (Buck)

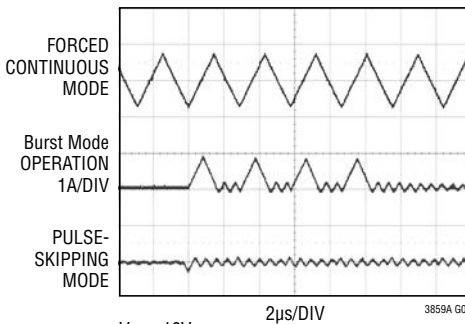

VIN = 10V
VOUT = 5V
ILOAD = 1mA
FIGURE 12 CIRCUIT

3859A G07

Soft Start-Up

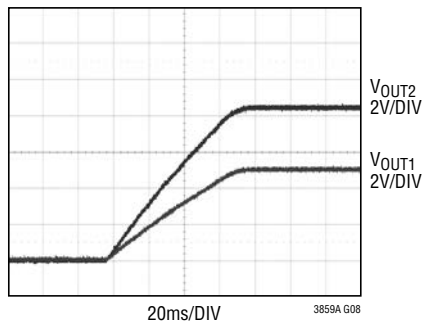
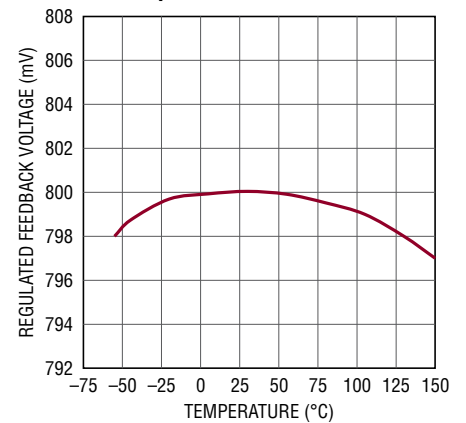

FIGURE 12 CIRCUIT

3859A G08

Buck Regulated Feedback Voltage vs Temperature



3859A G09

TYPICAL PERFORMANCE CHARACTERISTICS

Efficiency and Power Loss vs Output Current (Boost)

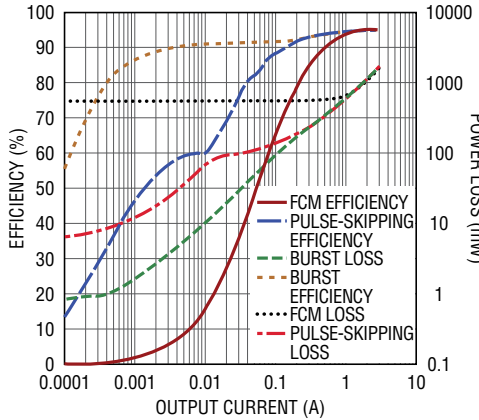
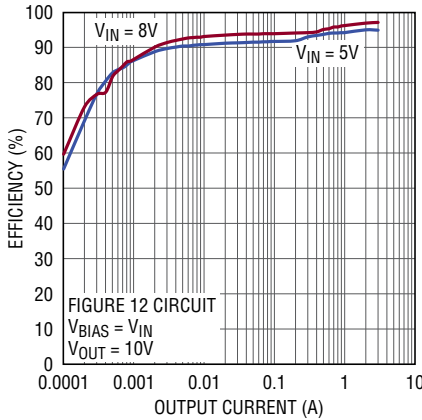

FIGURE 12 CIRCUIT
 $V_{IN} = 5V$, $V_{OUT} = 10V$, $V_{BIAS} = V_{IN}$

3859A G10

Efficiency vs Output Current (Boost)



3859A G11

Efficiency vs Input Voltage (Boost)

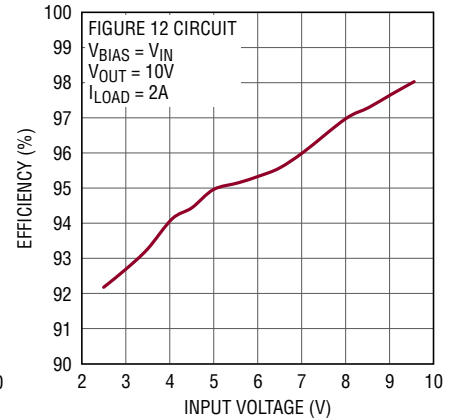

3859A G12

Load Step (Boost) Burst Mode Operation

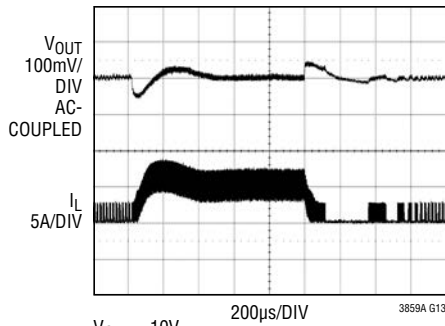

$V_{OUT} = 10V$
 $V_{IN} = 5V$
 FIGURE 12 CIRCUIT

3859A G13

Load Step (Boost) Pulse-Skipping Mode

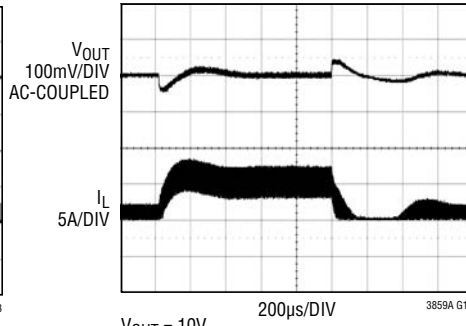

$V_{OUT} = 10V$
 $V_{IN} = 5V$
 FIGURE 12 CIRCUIT

3859A G14

Load Step (Boost) Forced Continuous Mode

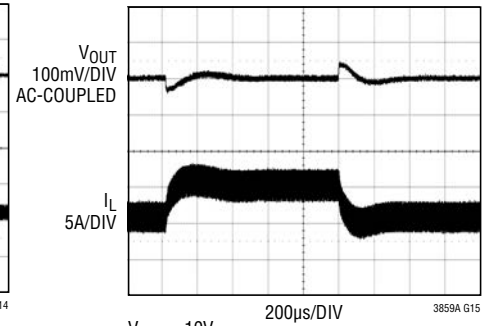

$V_{OUT} = 10V$
 $V_{IN} = 5V$
 FIGURE 12 CIRCUIT

3859A G15

Inductor Current at Light Load (Boost)

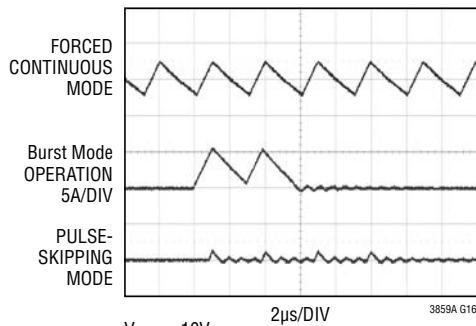

$V_{OUT} = 10V$
 $V_{IN} = 7V$
 $I_{LOAD} = 1mA$
 FIGURE 12 CIRCUIT

3859A G16

Soft Start-Up (Boost)

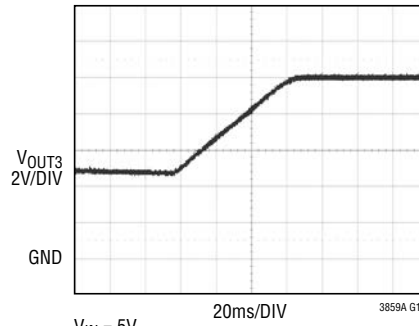

$V_{IN} = 5V$
 FIGURE 12 CIRCUIT

3859A G17

Boost Regulated Feedback Voltage vs Temperature

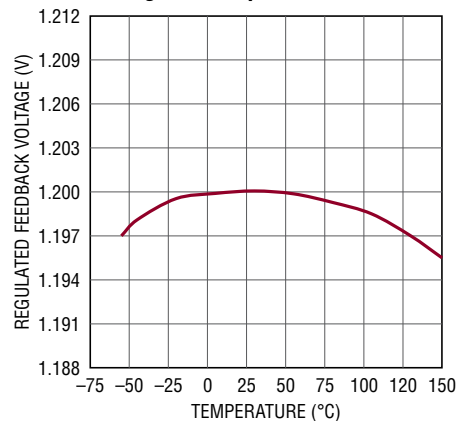

3859A G18

TYPICAL PERFORMANCE CHARACTERISTICS

INTV_{CC} Line Regulation

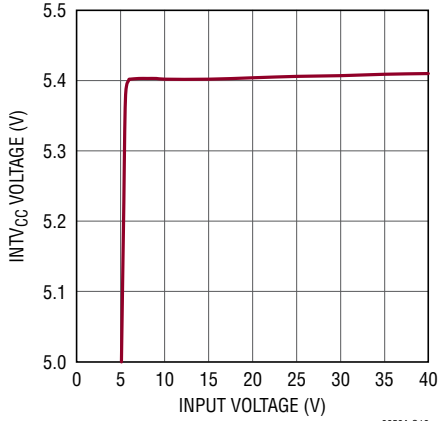

INTV_{CC} and EXT_{CC} vs Load Current

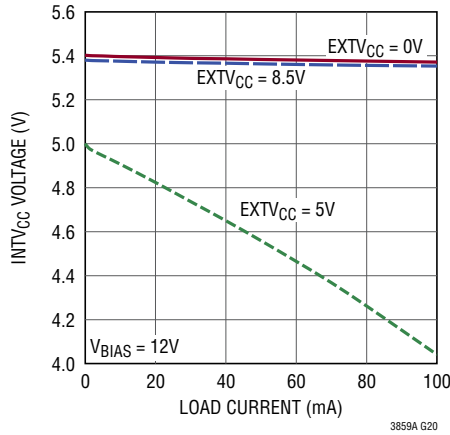

EXT_{CC} Switchover and INTV_{CC} Voltages vs Temperature

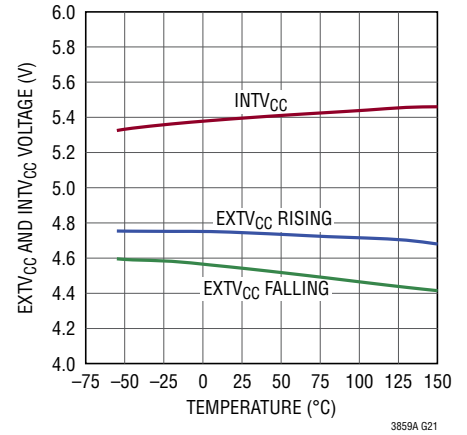

SENSE Pins Total Input Current vs V_{SENSE} Voltage

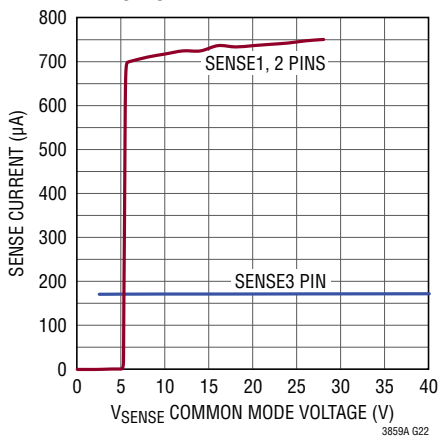

Buck SENSE⁻ Pin Input Bias Current vs Temperature

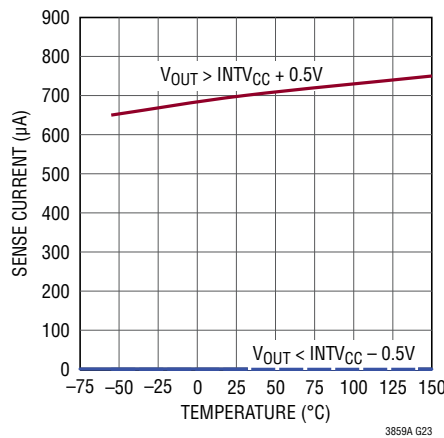

Boost SENSE Pin Total Input Current vs Temperature

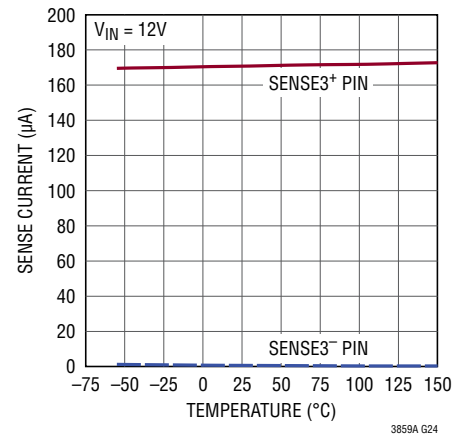

Maximum Current Sense Threshold vs Duty Cycle

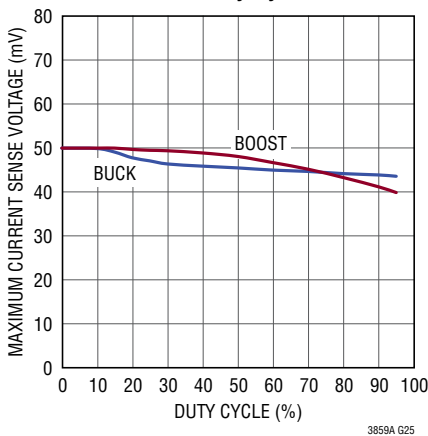

Maximum Current Sense Threshold vs I_{TH} Voltage

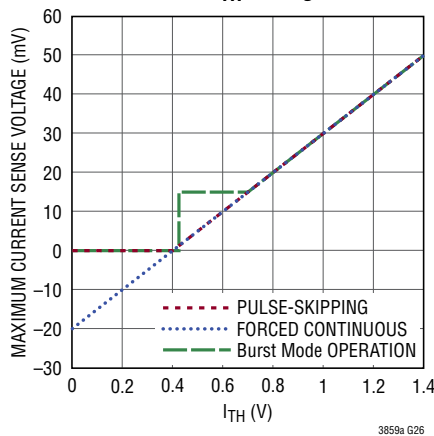

TRACK/SS Pull-Up Current vs Temperature

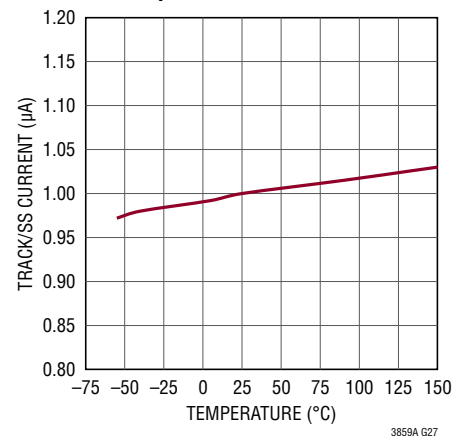

TYPICAL PERFORMANCE CHARACTERISTICS

Shutdown Current vs Temperature

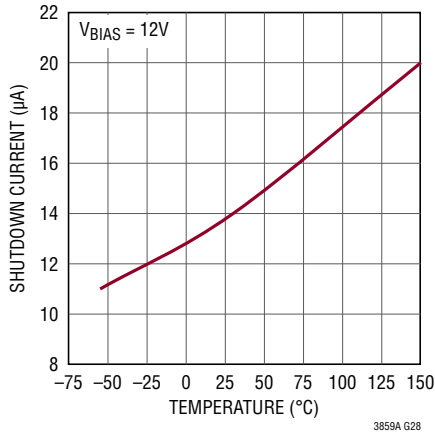

Shutdown Current vs Input Voltage

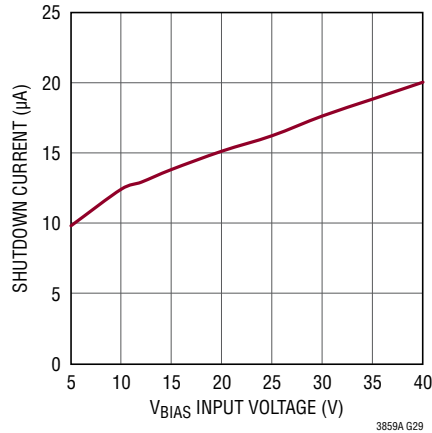

Quiescent Current vs Temperature

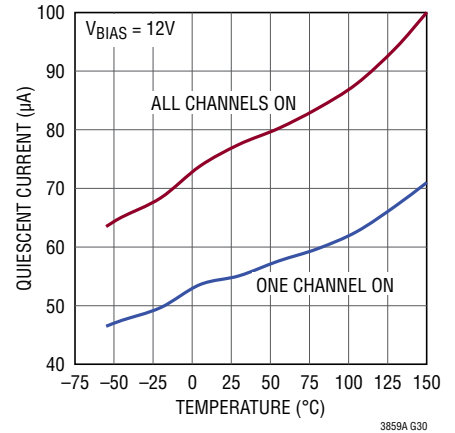

Buck Foldback Current Limit

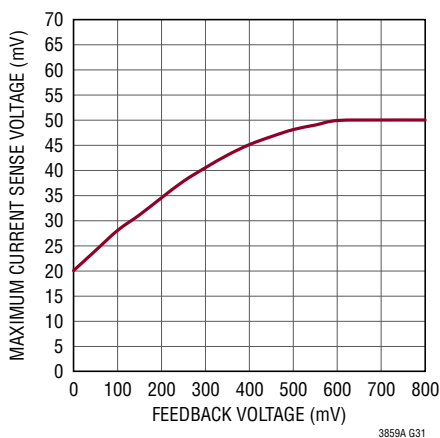

Oscillator Frequency vs Temperature

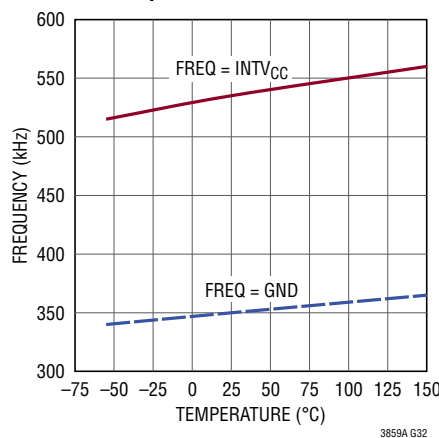

Undervoltage Lockout Threshold vs Temperature

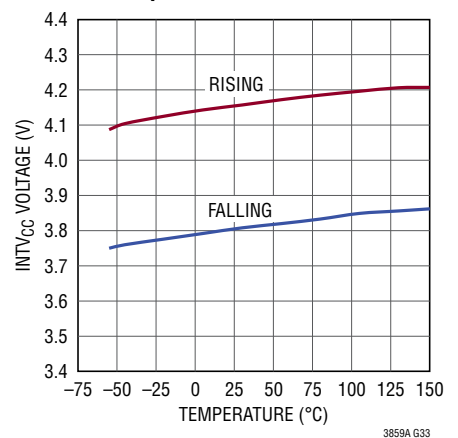

Shutdown (RUN) Threshold vs Temperature

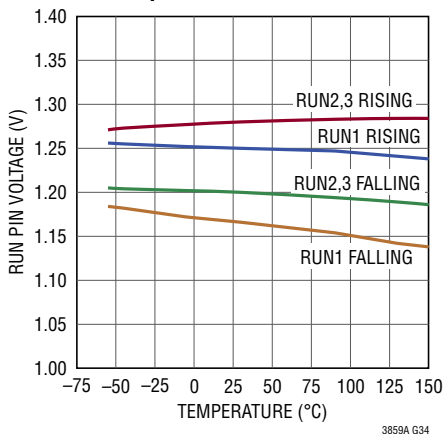

Charge Pump Charging Current vs Operating Frequency

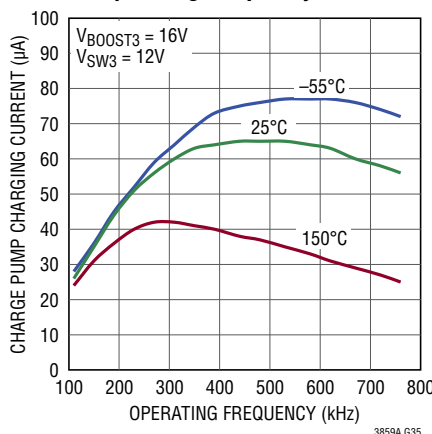

Charge Pump Charging Current vs Switch Voltage

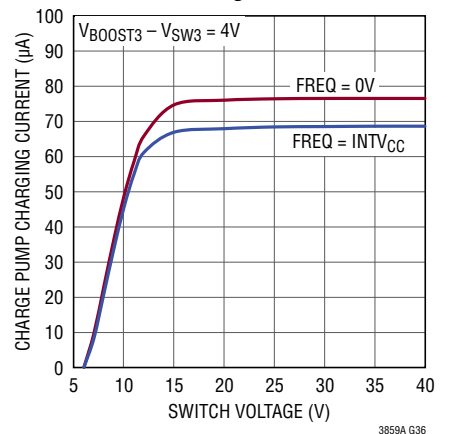

PIN FUNCTIONS (QFN/TSSOP)

FREQ (Pin 1/Pin 5): The Frequency Control Pin for the Internal VCO. Connecting the pin to GND forces the VCO to a fixed low frequency of 350kHz. Connecting the pin to INTV_{CC} forces the VCO to a fixed high frequency of 535kHz. Other frequencies between 50kHz and 900kHz can be programmed using a resistor between FREQ and GND. The resistor and an internal 20 μ A source current create a voltage used by the internal oscillator to set the frequency.

PLLIN/MODE (Pin 2/Pin 6): External Synchronization Input to Phase Detector and Forced Continuous Mode Input. When an external clock is applied to this pin, the phase-locked loop will force the rising TG1 signal to be synchronized with the rising edge of the external clock, and the regulators operate in forced continuous mode. When not synchronizing to an external clock, this input, which acts on all three controllers, determines how the LTC3859AA operates at light loads. Pulling this pin to ground selects Burst Mode operation. An internal 100k resistor to ground also invokes Burst Mode operation when the pin is floated. Tying this pin to INTV_{CC} forces continuous inductor current operation. Tying this pin to a voltage greater than 1.2V and less than INTV_{CC} – 1.3V selects pulse-skipping operation. This can be done by connecting a 100k resistor from this pin to INTV_{CC}.

SGND (Pin 8/Pin 12): Small Signal Ground common to all three controllers, must be routed separately from high current grounds to the common (–) terminals of the C_{IN} capacitors.

RUN1, RUN2, RUN3 (Pins 9, 10, 11/Pins 13, 14, 15): Digital Run Control Inputs for Each Controller. Forcing RUN1 below 1.17V and RUN2/RUN3 below 1.20V shuts down that controller. Forcing all of these pins below 0.7V shuts down the entire LTC3859A, reducing quiescent current to approximately 14 μ A.

OV3 (Pin 17/Pin 21): Overvoltage Open-Drain Logic Output for the Boost Regulator. OV3 is pulled to ground when the voltage on the V_{FB3} pin is under 110% of its set point, and becomes high impedance when V_{FB3} goes over 110% of its set point.

INTV_{CC} (Pin 22/Pin 26): Output of the Internal Linear Low Dropout Regulator. The driver and control circuits are powered from this voltage source. Must be decoupled to PGND with a minimum of 4.7 μ F ceramic or tantalum capacitor.

EXTV_{CC} (Pin 23/Pin 27): External Power Input to an Internal LDO Connected to INTV_{CC}. This LDO supplies INTV_{CC} power, bypassing the internal LDO powered from V_{BIAS} whenever EXTV_{CC} is higher than 4.7V. See EXTV_{CC} Connection in the Applications Information section. Do not float or exceed 14V on this pin.

V_{BIAS} (Pin 24/Pin 28): Main Bias Input Supply Pin. A bypass capacitor should be tied between this pin and the SGND pin.

BG1, BG2, BG3 (Pins 29, 21, 25/Pins 33, 25, 29): High Current Gate Drives for Bottom (Synchronous) N-Channel MOSFETs. Voltage swing at these pins is from ground to INTV_{CC}.

BOOST1, BOOST2, BOOST3 (Pins 30, 20, 26/Pins 34, 24, 30): Bootstrapped Supplies to the Top Side Floating Drivers. Capacitors are connected between the BOOST and SW pins and Schottky diodes are tied between the BOOST and INTV_{CC} pins. Voltage swing at the BOOST pins is from INTV_{CC} to (V_{IN} + INTV_{CC}).

SW1, SW2, SW3 (Pins 31, 19, 28/Pins 35, 23, 32): Switch Node Connections to Inductors.

TG1, TG2, TG3 (Pins 32, 18, 27/Pins 36, 22, 31): High Current Gate Drives for Top N-Channel MOSFETs. These are the outputs of floating drivers with a voltage swing equal to INTV_{CC} superimposed on the switch node voltage SW.

PGOOD1 (Pin 33/Pin 37): Open-Drain Logic Output. PGOOD1 is pulled to ground when the voltage on the V_{FB1} pin is not within $\pm 10\%$ of its set point.

PIN FUNCTIONS (QFN/TSSOP)

TRACK/SS1, TRACK/SS2, SS3 (Pins 34, 16, 3/Pins 38, 20, 7): External Tracking and Soft-Start Input. For the buck channels, the LTC3859A regulates the $V_{FB1,2}$ voltage to the smaller of 0.8V, or the voltage on the TRACK/SS1,2 pin. For the boost channel, the LTC3859A regulates the V_{FB3} voltage to the smaller of 1.2V, or the voltage on the SS3 pin. An internal 1 μ A pull-up current source is connected to this pin. A capacitor to ground at this pin sets the ramp time to final regulated output voltage. Alternatively, a resistor divider on another voltage supply connected to the TRACK/SS pins of the buck channels allow the LTC3859A buck outputs to track the other supply during start-up.

I_{TH1} , I_{TH2} , I_{TH3} (Pins 35, 15, 7/Pins 1, 19, 11): Error Amplifier Outputs and Switching Regulator Compensation Points. Each associated channel's current comparator trip point increases with this control voltage.

V_{FB1} , V_{FB2} , V_{FB3} (Pins 36, 14, 6/Pins 2, 18, 10): Receives the remotely sensed feedback voltage for each controller from an external resistive divider across the output.

SENSE1⁺, SENSE2⁺, SENSE3⁺ (Pins 37, 13, 4/Pins 3, 17, 8): The (+) Input to the Differential Current Comparators. The I_{TH} pin voltage and controlled offsets between the SENSE⁻ and SENSE⁺ pins in conjunction with R_{SENSE} set the current trip threshold. For the boost channel, the SENSE3⁺ pin supplies current to the current comparator.

SENSE1⁻, SENSE2⁻, SENSE3⁻ (Pins 38, 12, 5/Pins 4, 16, 9): The (-) Input to the Differential Current Comparators. When SENSE1,2⁻ for the buck channels is greater than $INTV_{CC}$, then SENSE1,2⁻ pin supplies current to the current comparator.

PGND (Exposed Pad Pin 39): Driver Power Ground. Connects to the sources of bottom N-channel MOSFETs and the (-) terminal(s) of C_{IN} . The exposed pad must be soldered to the PCB for rated electrical and thermal performance.

OPERATION (Refer to Functional Diagram)

Main Control Loop

The LTC3859A uses a constant frequency, current mode step-down architecture. The two buck controllers, channels 1 and 2, operate 180 degrees out of phase with each other. The boost controller, channel 3, operates in phase with channel 1. During normal operation, the external top MOSFET for the buck channels (the external bottom MOSFET for the boost channel) is turned on when the clock for that channel sets the RS latch, and is turned off when the main current comparator, ICMP, resets the RS latch. The peak inductor current at which ICMP trips and resets the latch is controlled by the voltage on the I_{TH} pin, which is the output of the error amplifier EA. The error amplifier compares the output voltage feedback signal at the V_{FB} pin, (which is generated with an external resistor divider connected across the output voltage, V_{OUT} , to ground) to the internal 0.800V reference voltage for the bucks (1.2V reference voltage for the boost). When the load current increases, it causes a slight decrease in V_{FB} relative to the reference, which causes the EA to increase the I_{TH} voltage until the average inductor current matches the new load current.

After the top MOSFET for the bucks (the bottom MOSFET for the boost) is turned off each cycle, the bottom MOSFET is turned on (the top MOSFET for the boost) until either the inductor current starts to reverse, as indicated by the current comparator IR, or the beginning of the next clock cycle.

INTV_{CC}/EXTV_{CC} Power

Power for the top and bottom MOSFET drivers and most other internal circuitry is derived from the INTV_{CC} pin. When the EXTV_{CC} pin is left open or tied to a voltage less than 4.7V, the V_{BIAS} LDO (low dropout linear regulator) supplies 5.4V from V_{BIAS} to INTV_{CC}. If EXTV_{CC} is taken above 4.7V, the V_{BIAS} LDO is turned off and an EXTV_{CC} LDO is turned on. Once enabled, the EXTV_{CC} LDO supplies 5.4V from EXTV_{CC} to INTV_{CC}. Using the EXTV_{CC} pin allows the INTV_{CC} power to be derived from a high efficiency external source such as one of the LTC3859A switching regulator outputs.

Each top MOSFET driver is biased from the floating bootstrap capacitor C_B , which normally recharges during each cycle through an external diode when the switch voltage goes low.

For buck channels 1 and 2, if the buck's input voltage decreases to a voltage close to its output, the loop may enter dropout and attempt to turn on the top MOSFET continuously. The dropout detector detects this and forces the top MOSFET off for about one twelfth of the clock period every tenth cycle to allow C_B to recharge.

Shutdown and Start-Up (RUN1, RUN2, RUN3 and TRACK/SS1, TRACK/SS2, SS3 Pins)

The three channels of the LTC3859A can be independently shut down using the RUN1, RUN2 and RUN3 pins. Pulling RUN1 below 1.17V and RUN2/RUN3 below 1.20V shuts down the main control loop for that channel. Pulling all three pins below 0.7V disables all controllers and most internal circuits, including the INTV_{CC} LDOs. In this state, the LTC3859A draws only 14 μ A of quiescent current.

Releasing a RUN pin allows a small internal current to pull up the pin to enable that controller. The RUN1 pin has a 6 μ A pull-up current while the RUN2 and RUN3 pins have a smaller 0.5 μ A. The 6 μ A current on RUN1 is designed to be large enough so that the RUN1 pin can be safely floated (to always enable the controller) without worry of condensation or other small board leakage pulling the pin down. This is ideal for always-on applications where one or more controllers are enabled continuously and never shut down.

Each RUN pin may also be externally pulled up or driven directly by logic. When driving a RUN pin with a low impedance source, do not exceed the absolute maximum rating of 8V. Each RUN pin has an internal 11V voltage clamp that allows the RUN pin to be connected through a resistor to a higher voltage (for example, V_{BIAS}), so long as the maximum current in the RUN pin does not exceed 100 μ A.

The start-up of each channel's output voltage V_{OUT} is controlled by the voltage on the TRACK/SS pin (TRACK/SS1 for channel 1, TRACK/SS2 for channel 2, SS3 for channel 3). When the voltage on the TRACK/SS pin is less than the 0.8V internal reference for the bucks and the 1.2V internal

OPERATION

reference for the boost, the LTC3859A regulates the V_{FB} voltage to the TRACK/SS pin voltage instead of the corresponding reference voltage. This allows the TRACK/SS pin to be used to program a soft-start by connecting an external capacitor from the TRACK/SS pin to SGND. An internal $1\mu\text{A}$ pull-up current charges this capacitor creating a voltage ramp on the TRACK/SS pin. As the TRACK/SS voltage rises linearly from 0V to 0.8V/1.2V (and beyond up to INTV_{CC}), the output voltage V_{OUT} rises smoothly from zero to its final value.

Alternatively the TRACK/SS pins for buck channels 1 and 2 can be used to cause the start-up of V_{OUT} to track that of another supply. Typically, this requires connecting to the TRACK/SS pin an external resistor divider from the other supply to ground (see the Applications Information section).

Light Load Current Operation (Burst Mode Operation, Pulse-Skipping, or Continuous Conduction) (PLLIN/MODE Pin)

The LTC3859A can be enabled to enter high efficiency Burst Mode operation, constant frequency pulse-skipping mode or forced continuous conduction mode at low load currents. To select Burst Mode operation, tie the PLLIN/MODE pin to ground. To select forced continuous operation, tie the PLLIN/MODE pin to INTV_{CC} . To select pulse-skipping mode, tie the PLLIN/MODE pin to a DC voltage greater than 1.2V and less than $\text{INTV}_{CC} - 1.3\text{V}$.

When a controller is enabled for Burst Mode operation, the minimum peak current in the inductor is set to approximately 25% of the maximum sense voltage (30% for the boost) even though the voltage on the I_{TH} pin indicates a lower value. If the average inductor current is higher than the load current, the error amplifier EA will decrease the voltage on the I_{TH} pin. When the I_{TH} voltage drops below 0.425V, the internal sleep signal goes high (enabling sleep mode) and both external MOSFETs are turned off. The I_{TH} pin is then disconnected from the output of the EA and parked at 0.450V.

In sleep mode, much of the internal circuitry is turned off, reducing the quiescent current that the LTC3859A draws. If one channel is in sleep mode and the other two are shut down, the LTC3859A draws only $55\mu\text{A}$ of quiescent current. If two channels are in sleep mode and the other

shut down, it draws only $65\mu\text{A}$ of quiescent current. If all three controllers are enabled in sleep mode, the LTC3859A draws only $80\mu\text{A}$ of quiescent. In sleep mode, the load current is supplied by the output capacitor. As the output voltage decreases, the EA's output begins to rise. When the output voltage drops enough, the I_{TH} pin is reconnected to the output of the EA, the sleep signal goes low, and the controller resumes normal operation by turning on the top external MOSFET on the next cycle of the internal oscillator.

When a controller is enabled for Burst Mode operation, the inductor current is not allowed to reverse. The reverse current comparator (IR) turns off the bottom external MOSFET (the top external MOSFET for the boost) just before the inductor current reaches zero, preventing it from reversing and going negative. Thus, the controller operates in discontinuous operation.

In forced continuous operation or clocked by an external clock source to use the phase-locked loop (see the Frequency Selection and Phase-Locked Loop section), the inductor current is allowed to reverse at light loads or under large transient conditions. The peak inductor current is determined by the voltage on the I_{TH} pin, just as in normal operation. In this mode, the efficiency at light loads is lower than in Burst Mode operation. However, continuous operation has the advantage of lower output voltage ripple and less interference to audio circuitry. In forced continuous mode, the output ripple is independent of load current.

When the PLLIN/MODE pin is connected for pulse-skipping mode, the LTC3859A operates in PWM pulse-skipping mode at light loads. In this mode, constant frequency operation is maintained down to approximately 1% of designed maximum output current. At very light loads, the current comparator ICMP may remain tripped for several cycles and force the external top MOSFET to stay off for the same number of cycles (i.e., skipping pulses). The inductor current is not allowed to reverse (discontinuous operation). This mode, like forced continuous operation, exhibits low output ripple as well as low audio noise and reduced RF interference as compared to Burst Mode operation. It provides higher low current efficiency than forced continuous mode, but not nearly as high as Burst Mode operation.

OPERATION

Frequency Selection and Phase-Locked Loop (FREQ and PLLIN/MODE Pins)

The selection of switching frequency is a trade-off between efficiency and component size. Low frequency operation increases efficiency by reducing MOSFET switching losses, but requires larger inductance and/or capacitance to maintain low output ripple voltage.

The switching frequency of the LTC3859A's controllers can be selected using the FREQ pin.

If the PLLIN/MODE pin is not being driven by an external clock source, the FREQ pin can be tied to SGND, tied to INTV_{CC}, or programmed through an external resistor. Tying FREQ to SGND selects 350kHz while tying FREQ to INTV_{CC} selects 535kHz. Placing a resistor between FREQ and SGND allows the frequency to be programmed between 50kHz and 900kHz.

A phase-locked loop (PLL) is available on the LTC3859A to synchronize the internal oscillator to an external clock source that is connected to the PLLIN/MODE pin. The LTC3859A's phase detector adjusts the voltage (through an internal lowpass filter) of the VCO input to align the turn-on of controller 1's external top MOSFET to the rising edge of the synchronizing signal. Thus, the turn-on of controller 2's external top MOSFET is 180 degrees out of phase to the rising edge of the external clock source.

The VCO input voltage is pre-biased to the operating frequency set by the FREQ pin before the external clock is applied. If prebiased near the external clock frequency, the PLL loop only needs to make slight changes to the VCO input in order to synchronize the rising edge of the external clock's to the rising edge of TG1. The ability to pre-bias the loop filter allows the PLL to lock in rapidly without deviating far from the desired frequency.

The typical capture range of the LTC3859A's phase-locked loop is from approximately 55kHz to 1MHz, with a guarantee over all manufacturing variations to be between 75kHz and 850kHz. In other words, the LTC3859A's PLL is guaranteed to lock to an external clock source whose frequency is between 75kHz and 850kHz.

The typical input clock thresholds on the PLLIN/MODE pin are 1.6V (rising) and 1.2V (falling).

Boost Controller Operation When $V_{IN} > V_{OUT}$

When the input voltage to the boost channel rises above its regulated V_{OUT} voltage, the controller can behave differently depending on the mode, inductor current and V_{IN} voltage. In forced continuous mode, the loop works to keep the top MOSFET on continuously once V_{IN} rises above V_{OUT} . An internal charge pump delivers current to the boost capacitor from the BOOST3 pin to maintain a sufficiently high TG voltage. (The amount of current the charge pump can deliver is characterized by two curves in the Typical Performance Characteristics section.)

In pulse-skipping mode, if V_{IN} is between 100% and 110% of the regulated V_{OUT} voltage, TG3 turns on if the inductor current rises above approximately 3% of the programmed I_{LIM} current. If the part is programmed in Burst Mode operation under this same V_{IN} window, then TG3 turns on at the same threshold current as long as the chip is awake (one of the buck channels is awake and switching). If both buck channels are asleep or shut down in this V_{IN} window, then TG3 will remain off regardless of the inductor current.

If V_{IN} rises above 110% of the regulated V_{OUT} voltage in any mode, the controller turns on TG3 regardless of the inductor current. In Burst Mode operation, however, the internal charge pump turns off if the entire chip is asleep (the two buck channels are asleep or shut down). With the charge pump off, there would be nothing to prevent the boost capacitor from discharging, resulting in an insufficient TG voltage needed to keep the top MOSFET completely on. The charge pump turns back on when the chip wakes up, and it remains on as long as one of the buck channels is actively switching.

Boost Controller at Low SENSE Pin Common Voltage

The current comparator of the boost controller is powered directly from the SENSE3+ pin and can operate to voltages as low as 2.5V. Since this is lower than the V_{BIAS} UVLO of the chip, V_{BIAS} can be connected to the output of the boost controller, as illustrated in the typical application circuit in Figure 12. This allows the boost controller to handle input voltage transients down to 2.5V while maintaining output voltage regulation. If the SENSE3+ rises back above 2.5V, the SS3 pin will be released initiating a new soft-start sequence.

OPERATION

Buck Controller Output Overvoltage Protection

The two buck channels have an overvoltage comparator that guards against transient overshoots as well as other more serious conditions that may overvoltage their outputs. When the $V_{FB1,2}$ pin rises by more than 10% above its regulation point of 0.800V, the top MOSFET is turned off and the bottom MOSFET is turned on until the overvoltage condition is cleared.

Channel 1 Power Good (PGOOD1)

Channel 1 has a PGOOD1 pin that is connected to an open drain of an internal N-channel MOSFET. The MOSFET turns on and pulls the PGOOD1 pin low when the V_{FB1} pin voltage is not within $\pm 10\%$ of the 0.8V reference voltage for the buck channel. The PGOOD1 pin is also pulled low when the RUN1 pin is low (shut down). When the V_{FB1} pin voltage is within the $\pm 10\%$ requirement, the MOSFET is turned off and the pin is allowed to be pulled up by an external resistor to a source no greater than 6V.

Boost Overvoltage Indicator (OV3)

The OV3 pin is an overvoltage indicator that signals whether the output voltage of the channel 3 boost controller goes over its programmed regulated voltage. The pin is connected to an open drain of an internal N-channel MOSFET. The MOSFET turns on and pulls the OV3 pin low when the V_{FB3} pin voltage is less than 110% of the 1.2V reference voltage for the boost channel. The OV3 pin is also pulled low when the RUN3 pin is low (shut down). When the V_{FB3} pin voltage goes higher than 110% of the 1.2V reference, the MOSFET is turned off and the pin is allowed to be pulled up by an external resistor to a source no greater than 6V.

Buck Foldback Current

When the buck output voltage falls to less than 70% of its nominal level, foldback current limiting is activated, progressively lowering the peak current limit in proportion to the severity of the overcurrent or short-circuit condition. Foldback current limiting is disabled during the soft-start interval (as long as the V_{FB} voltage is keeping up with the TRACK/SS1,2 voltage). There is no foldback current limiting for the boost channel.

THEORY AND BENEFITS OF 2-PHASE OPERATION

Why the need for 2-phase operation? Up until the 2-phase family, constant-frequency dual switching regulators operated both channels in phase (i.e., single-phase operation). This means that both switches turned on at the same time, causing current pulses of up to twice the amplitude of those for one regulator to be drawn from the input capacitor and battery. These large amplitude current pulses increased the total RMS current flowing from the input capacitor, requiring the use of more expensive input capacitors and increasing both EMI and losses in the input capacitor and battery.

With 2-phase operation, the two buck controllers of the LTC3859A are operated 180 degrees out of phase. This effectively interleaves the current pulses drawn by the switches, greatly reducing the overlap time where they add together. The result is a significant reduction in total RMS input current, which in turn allows less expensive input capacitors to be used, reduces shielding requirements for EMI and improves real world operating efficiency.

OPERATION

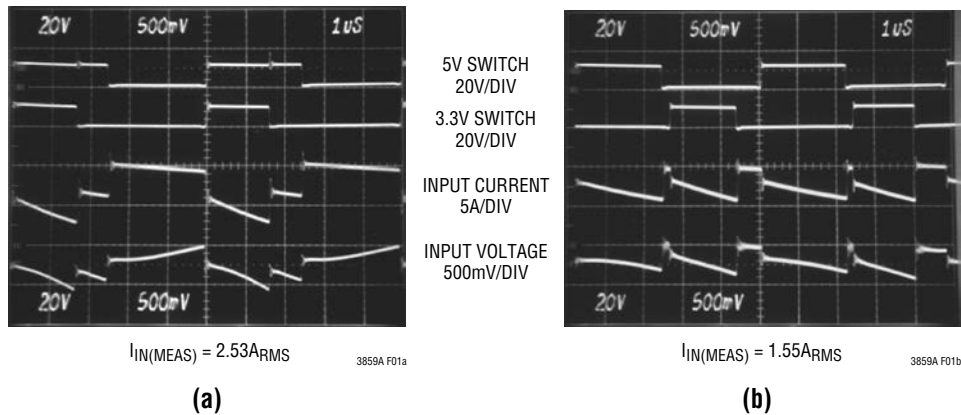

Figure 1. Input Waveforms Comparing Single-Phase (a) and 2-Phase (b) Operation for Dual Switching Regulators Converting 12V to 5V and 3.3V at 3A Each. The Reduced Input Ripple with the 2-Phase Regulator Allows Less Expensive Input Capacitors, Reduces Shielding Requirements for EMI and Improves Efficiency

Figure 1 compares the input waveforms for a representative single-phase dual switching regulator to the 2-phase dual buck controllers of the LTC3859A. An actual measurement of the RMS input current under these conditions shows that 2-phase operation dropped the input current from $2.53A_{RMS}$ to $1.55A_{RMS}$. While this is an impressive reduction in itself, remember that the power losses are proportional to I_{RMS}^2 , meaning that the actual power wasted is reduced by a factor of 2.66. The reduced input ripple voltage also means less power is lost in the input power path, which could include batteries, switches, trace/connector resistances and protection circuitry. Improvements in both conducted and radiated EMI also directly accrue as a result of the reduced RMS input current and voltage.

Of course, the improvement afforded by 2-phase operation is a function of the dual switching regulator's relative duty cycles which, in turn, are dependent upon the input voltage V_{IN} (Duty Cycle = V_{OUT}/V_{IN}). Figure 2 shows how the RMS input current varies for single-phase and 2-phase operation for 3.3V and 5V regulators over a wide input voltage range.

It can readily be seen that the advantages of 2-phase operation are not just limited to a narrow operating range, for most applications is that 2-phase operation will reduce the input capacitor requirement to that for just one channel operating at maximum current and 50% duty cycle.

The schematic on the first page is a basic LTC3859A application circuit. External component selection is driven by the load requirement, and begins with the selection of R_{SENSE} and the inductor value. Next, the power MOSFETs are selected. Finally, C_{IN} and C_{OUT} are selected.

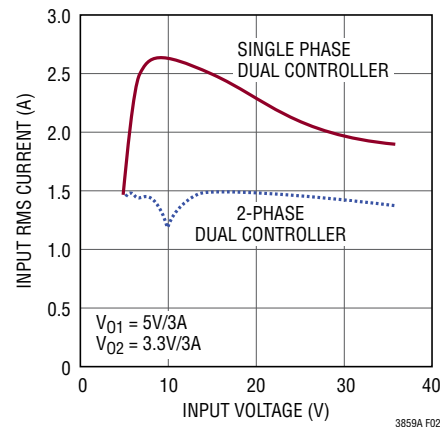

Figure 2. RMS Input Current Comparison

APPLICATIONS INFORMATION

The Typical Application on the first page is a basic LTC3859A application circuit. LTC3859A can be configured to use either DCR (inductor resistance) sensing or low value resistor sensing. The choice between the two current sensing schemes is largely a design trade-off between cost, power consumption, and accuracy. DCR sensing is becoming popular because it saves expensive current sensing resistors and is more power efficient, especially in high current applications. However, current sensing resistors provide the most accurate current limits for the controller. Other external component selection is driven by the load requirement, and begins with the selection of R_{SENSE} (if R_{SENSE} is used) and inductor value. Next, the power MOSFETs and Schottky diodes are selected. Finally, input and output capacitors are selected.

SENSE⁺ and SENSE⁻ Pins

The SENSE⁺ and SENSE⁻ pins are the inputs to the current comparators.

Buck Controllers (SENSE1⁺/SENSE1⁻, SENSE2⁺/SENSE2⁻): The common mode voltage range on these pins is 0V to 28V (absolute maximum), enabling the LTC3859A to regulate buck output voltages up to a nominal 24V (allowing margin for tolerances and transients). The SENSE⁺ pin is high impedance over the full common mode range, drawing at most $\pm 1\mu\text{A}$. This high impedance allows the current comparators to be used in inductor DCR sensing. The impedance of the SENSE⁻ pin changes depending on the common mode voltage. When SENSE⁻ is less than $\text{INTV}_{\text{CC}} - 0.5\text{V}$, a small current of less than $1\mu\text{A}$ flows out of the pin. When SENSE⁻ is above $\text{INTV}_{\text{CC}} + 0.5\text{V}$, a higher current ($\approx 700\mu\text{A}$) flows into the pin. Between $\text{INTV}_{\text{CC}} - 0.5\text{V}$ and $\text{INTV}_{\text{CC}} + 0.5\text{V}$, the current transitions from the smaller current to the higher current.

Boost Controller (SENSE3⁺/SENSE3⁻): The common mode input range for these pins is 2.5V to 38V, allowing the boost converter to operate from inputs over this full range. The SENSE3⁺ pin also provides power to the current comparator and draws about $170\mu\text{A}$ during normal operation (when not shut down or asleep in Burst Mode operation). There is a small bias current of less than $1\mu\text{A}$ that flows out of the SENSE3⁻ pin. This high impedance

on the SENSE3⁻ pin allows the current comparator to be used in inductor DCR sensing.

Filter components mutual to the sense lines should be placed close to the LTC3859A, and the sense lines should run close together to a Kelvin connection underneath the current sense element (shown in Figure 3). Sensing current elsewhere can effectively add parasitic inductance and capacitance to the current sense element, degrading the information at the sense terminals and making the programmed current limit unpredictable. If DCR sensing is used (Figure 4b), sense resistor R1 should be placed close to the switching node, to prevent noise from coupling into sensitive small-signal nodes.

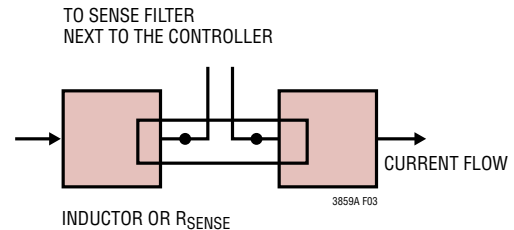

Figure 3. Sense Lines Placement with Inductor or Sense Resistor

Low Value Resistor Current Sensing

A typical sensing circuit using a discrete resistor is shown in Figure 4a. R_{SENSE} is chosen based on the required output current.

The current comparators have a maximum threshold $V_{SENSE(\text{MAX})}$ of 50mV. The current comparator threshold sets the peak of the inductor current, yielding a maximum average output current, I_{MAX} , equal to the peak value less half the peak-to-peak ripple current, ΔI_L . To calculate the sense resistor value, use the equation:

$$R_{\text{SENSE}} = \frac{V_{\text{SENSE}(\text{MAX})}}{I_{\text{MAX}} + \frac{\Delta I_L}{2}}$$

When using the buck controllers in very low dropout conditions, the maximum output current level will be reduced due to the internal compensation required to meet stability criterion for buck regulators operating at greater than 50% duty factor. A curve is provided in the Typical Performance Characteristics section to estimate this reduction in peak output current level depending upon the operating duty factor.

APPLICATIONS INFORMATION

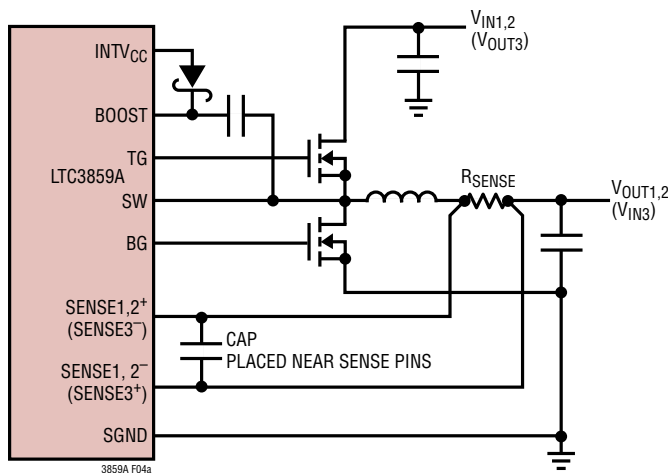

4a. Using a Resistor to Sense Current

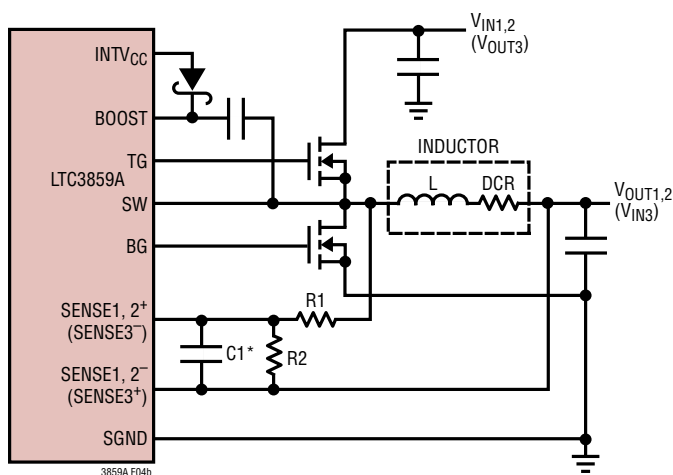

*PLACE C1 NEAR SENSE PINS $(R1 \parallel R2) \cdot C1 = L/DCR$
 $R_{SENSE(EQ)} = DCR/(R1+R2)$

4b. Using the Inductor DCR to Sense Current

Figure 4. Current Sensing Methods

Inductor DCR Sensing

For applications requiring the highest possible efficiency at high load currents, the LTC3859A is capable of sensing the voltage drop across the inductor DCR, as shown in Figure 4b. The DCR of the inductor represents the small amount of DC winding resistance of the copper, which can be less than 1mΩ for today's low value, high current inductors. In a high current application requiring such an inductor, conduction loss through a sense resistor would cost several points of efficiency compared to DCR sensing.

If the external $R1 \parallel R2 \cdot C1$ time constant is chosen to be exactly equal to the L/DCR time constant, the voltage drop across the external capacitor is equal to the drop across the inductor DCR multiplied by $R2/(R1 + R2)$. $R2$ scales the voltage across the sense terminals for applications where the DCR is greater than the target sense resistor value. To properly dimension the external filter components, the DCR of the inductor must be known. It can be measured using a good RLC meter, but the DCR tolerance is not always the same and varies with temperature; consult the manufacturers' data sheets for detailed information.

Using the inductor ripple current value from the Inductor Value Calculation section, the target sense resistor value is:

$$R_{(EQUIV)} = \frac{V_{SENSE(MAX)}}{I_{MAX} + \frac{\Delta I_L}{2}}$$

To ensure that the application will deliver full load current over the full operating temperature range, determine $R_{SENSE(EQUIV)}$, keeping in mind that the maximum current sense threshold ($V_{SENSE(MAX)}$) for the LTC3859A is fixed at 50mV.

Next, determine the DCR of the inductor. Where provided, use the manufacturer's maximum value, usually given at 20°C. Increase this value to account for the temperature coefficient of resistance, which is approximately 0.4%/°C. A conservative value for $T_{L(MAX)}$ is 100°C.

To scale the maximum inductor DCR to the desired sense resistor value, use the divider ratio:

$$R_D = \frac{R_{SENSE(EQUIV)}}{DCR_{MAX} \text{ at } T_{L(MAX)}}$$

$C1$ is usually selected to be in the range of 0.1μF to 0.47μF. This forces $R1 \parallel R2$ to around 2k, reducing error that might have been caused by the SENSE+ pin's ±1μA current.

The equivalent resistance $R1 \parallel R2$ is scaled to the room temperature inductance and maximum DCR:

$$R1 \parallel R2 = \frac{L}{(DCR \text{ at } 20^\circ\text{C}) \cdot C1}$$

The sense resistor values are:

$$R1 = \frac{R1 \parallel R2}{R_D}; \quad R2 = \frac{R1 \cdot R_D}{1 - R_D}$$

APPLICATIONS INFORMATION

The maximum power loss in R1 is related to duty cycle. For the buck controllers, the maximum power loss will occur in continuous mode at the maximum input voltage:

$$P_{\text{LOSS R1}} = \frac{(V_{\text{IN(MAX)}} - V_{\text{OUT}}) \cdot V_{\text{OUT}}}{R1}$$

For the boost controller, the maximum power loss in R1 will occur in continuous mode at $V_{\text{IN}} = 1/2 \cdot V_{\text{OUT}}$:

$$P_{\text{LOSS R1}} = \frac{(V_{\text{OUT(MAX)}} - V_{\text{IN}}) \cdot V_{\text{IN}}}{R1}$$

Ensure that R1 has a power rating higher than this value. If high efficiency is necessary at light loads, consider this power loss when deciding whether to use DCR sensing or sense resistors. Light load power loss can be modestly higher with a DCR network than with a sense resistor, due to the extra switching losses incurred through R1. However, DCR sensing eliminates a sense resistor, reduces conduction losses and provides higher efficiency at heavy loads. Peak efficiency is about the same with either method.

Inductor Value Calculation

The operating frequency and inductor selection are inter-related in that higher operating frequencies allow the use of smaller inductor and capacitor values. So why would anyone ever choose to operate at lower frequencies with larger components? The answer is efficiency. A higher frequency generally results in lower efficiency because of MOSFET gate charge losses. In addition to this basic trade-off, the effect of inductor value on ripple current and low current operation must also be considered.

The inductor value has a direct effect on ripple current. The inductor ripple current ΔI_L decreases with higher inductance or frequency. For the buck controllers, ΔI_L increases with higher V_{IN} :

$$\Delta I_L = \frac{1}{(f)(L)} V_{\text{OUT}} \left(1 - \frac{V_{\text{OUT}}}{V_{\text{IN}}} \right)$$

For the boost controller, the inductor ripple current ΔI_L increases with higher V_{OUT} :

$$\Delta I_L = \frac{1}{(f)(L)} V_{\text{IN}} \left(1 - \frac{V_{\text{IN}}}{V_{\text{OUT}}} \right)$$

Accepting larger values of ΔI_L allows the use of low inductances, but results in higher output voltage ripple and greater core losses. A reasonable starting point for setting ripple current is $\Delta I_L = 0.3(I_{\text{MAX}})$. The maximum ΔI_L occurs at the maximum input voltage for the bucks and $V_{\text{IN}} = 1/2 \cdot V_{\text{OUT}}$ for the boost.

The inductor value also has secondary effects. The transition to Burst Mode operation begins when the average inductor current required results in a peak current below 25% of the current limit (30% for the boost) determined by R_{SENSE} . Lower inductor values (higher ΔI_L) will cause this to occur at lower load currents, which can cause a dip in efficiency in the upper range of low current operation. In Burst Mode operation, lower inductance values will cause the burst frequency to decrease.

Inductor Core Selection

Once the value for L is known, the type of inductor must be selected. High efficiency converters generally cannot afford the core loss found in low cost powdered iron cores, forcing the use of more expensive ferrite or molypermalloy cores. Actual core loss is independent of core size for a fixed inductor value, but it is very dependent on inductance selected. As inductance increases, core losses go down. Unfortunately, increased inductance requires more turns of wire and therefore copper losses will increase.

Ferrite designs have very low core loss and are preferred at high switching frequencies, so design goals can concentrate on copper loss and preventing saturation. Ferrite core material saturates "hard," which means that inductance collapses abruptly when the peak design current is exceeded. This results in an abrupt increase in inductor ripple current and consequent output voltage ripple. Do not allow the core to saturate!

APPLICATIONS INFORMATION

Power MOSFET and Schottky Diode (Optional) Selection

Two external power MOSFETs must be selected for each controller in the LTC3859A: one N-channel MOSFET for the top switch (main switch for the buck, synchronous for the boost), and one N-channel MOSFET for the bottom switch (main switch for the boost, synchronous for the buck).

The peak-to-peak drive levels are set by the V_{INTVCC} voltage. This voltage is typically 5.4V during start-up (see V_{EXTVCC} Pin Connection). Consequently, logic-level threshold MOSFETs must be used in most applications. Pay close attention to the BV_{DSS} specification for the MOSFETs as well; many of the logic level MOSFETs are limited to 30V or less.

Selection criteria for the power MOSFETs include the on-resistance $R_{DS(ON)}$, Miller capacitance C_{MILLER} , input voltage and maximum output current. Miller capacitance, C_{MILLER} , can be approximated from the gate charge curve usually provided on the MOSFET manufacturers' data sheet. C_{MILLER} is equal to the increase in gate charge along the horizontal axis while the curve is approximately flat divided by the specified change in V_{DS} . This result is then multiplied by the ratio of the application applied V_{DS} to the gate charge curve specified V_{DS} . When the IC is operating in continuous mode the duty cycles for the top and bottom MOSFETs are given by:

$$\text{Buck Main Switch Duty Cycle} = \frac{V_{OUT}}{V_{IN}}$$

$$\text{Buck Sync Switch Duty Cycle} = \frac{V_{IN} - V_{OUT}}{V_{IN}}$$

$$\text{Boost Main Switch Duty Cycle} = \frac{V_{OUT} - V_{IN}}{V_{OUT}}$$

$$\text{Boost Sync Switch Duty Cycle} = \frac{V_{IN}}{V_{OUT}}$$

The MOSFET power dissipations at maximum output current are given by:

$$P_{\text{MAIN_BUCK}} = \frac{V_{OUT}}{V_{IN}} (I_{OUT(MAX)})^2 (1 + \delta) R_{DS(ON)} + (V_{IN})^2 \left(\frac{I_{OUT(MAX)}}{2} \right) (R_{DR}) (C_{MILLER}) \cdot$$

$$\left[\frac{1}{V_{INTVCC} - V_{THMIN}} + \frac{1}{V_{THMIN}} \right] (f)$$

$$P_{\text{SYNC_BUCK}} = \frac{V_{IN} - V_{OUT}}{V_{IN}} (I_{OUT(MAX)})^2 (1 + \delta) R_{DS(ON)}$$

$$P_{\text{MAIN_BOOST}} = \frac{(V_{OUT} - V_{IN}) V_{OUT}}{V_{IN}^2} (I_{OUT(MAX)})^2 \cdot$$

$$(1 + \delta) R_{DS(ON)} + \left(\frac{V_{OUT}}{V_{IN}} \right)^3 \left(\frac{I_{OUT(MAX)}}{2} \right) \cdot$$

$$(R_{DR}) (C_{MILLER}) \cdot \left[\frac{1}{V_{INTVCC} - V_{THMIN}} + \frac{1}{V_{THMIN}} \right] (f)$$

$$P_{\text{SYNC_BOOST}} = \frac{V_{OUT}}{V_{IN}} (I_{OUT(MAX)})^2 (1 + \delta) R_{DS(ON)}$$

where ζ is the temperature dependency of $R_{DS(ON)}$ and RDR (approximately 2Ω) is the effective driver resistance at the MOSFET's Miller threshold voltage. V_{THMIN} is the typical MOSFET minimum threshold voltage.

Both MOSFETs have I^2R losses while the main N-channel equations for the buck and boost controllers include an additional term for transition losses, which are highest at high input voltages for the bucks and low input voltages for the boost. For $V_{IN} < 20V$ (high V_{IN} for the boost) the high current efficiency generally improves with larger MOSFETs, while for $V_{IN} > 20V$ (low V_{IN} for the boost) the transition losses rapidly increase to the point that the use of a higher $R_{DS(ON)}$ device with lower C_{MILLER} actually provides higher

APPLICATIONS INFORMATION

efficiency. The synchronous MOSFET losses for the buck controllers are greatest at high input voltage when the top switch duty factor is low or during a short-circuit when the synchronous switch is on close to 100% of the period. The synchronous MOSFET losses for the boost controller are greatest when the input voltage approaches the output voltage or during an overvoltage event when the synchronous switch is on 100% of the period.

The term $(1 + \zeta)$ is generally given for a MOSFET in the form of a normalized $R_{DS(ON)}$ vs Temperature curve, but $\zeta = 0.005/^\circ\text{C}$ can be used as an approximation for low voltage MOSFETs.

An optional Schottky diode placed across the synchronous MOSFET conducts during the dead-time between the conduction of the two power MOSFETs. This prevents the body diode of the synchronous MOSFET from turning on, storing charge during the dead-time and requiring a reverse recovery period that could cost as much as 3% in efficiency at high V_{IN} . A 1A to 3A Schottky is generally a good compromise for both regions of operation due to the relatively small average current. Larger diodes result in additional transition losses due to their larger junction capacitance.

Boost C_{IN} , C_{OUT} Selection

The input ripple current in a boost converter is relatively low (compared with the output ripple current), because this current is continuous. The boost input capacitor C_{IN} voltage rating should comfortably exceed the maximum input voltage. Although ceramic capacitors can be relatively tolerant of overvoltage conditions, aluminum electrolytic capacitors are not. Be sure to characterize the input voltage for any possible overvoltage transients that could apply excess stress to the input capacitors.

The value of C_{IN} is a function of the source impedance, and in general, the higher the source impedance, the higher the required input capacitance. The required amount of input capacitance is also greatly affected by the duty cycle. High output current applications that also experience high duty cycles can place great demands on the input supply, both in terms of DC current and ripple current.

In a boost converter, the output has a discontinuous current, so C_{OUT} must be capable of reducing the output voltage ripple. The effects of ESR (equivalent series resistance) and the bulk capacitance must be considered when choosing the right capacitor for a given output ripple voltage. The steady ripple due to charging and discharging the bulk capacitance is given by:

$$\text{Ripple} = \frac{I_{OUT(MAX)} \cdot (V_{OUT} - V_{IN(MIN)})}{C_{OUT} \cdot V_{OUT} \cdot f} V$$

where C_{OUT} is the output filter capacitor.

The steady ripple due to the voltage drop across the ESR is given by:

$$\Delta V_{ESR} = I_{L(MAX)} \cdot ESR$$

Multiple capacitors placed in parallel may be needed to meet the ESR and RMS current handling requirements. Dry tantalum, special polymer, aluminum electrolytic and ceramic capacitors are all available in surface mount packages. Ceramic capacitors have excellent low ESR characteristics but can have a high voltage coefficient. Capacitors are now available with low ESR and high ripple current ratings such as OS-CON and POSCAP.

Buck C_{IN} , C_{OUT} Selection

The selection of C_{IN} for the two buck controllers is simplified by the 2-phase architecture and its impact on the worst-case RMS current drawn through the input network (battery/fuse/capacitor). It can be shown that the worst-case capacitor RMS current occurs when only one controller is operating. The controller with the highest $(V_{OUT})(I_{OUT})$ product needs to be used in the formula shown in Equation (1) to determine the maximum RMS capacitor current requirement. Increasing the output current drawn from the other controller will actually decrease the input RMS ripple current from its maximum value. The out-of-phase technique typically reduces the input capacitor's RMS ripple current by a factor of 30% to 70% when compared to a single phase power supply solution.

APPLICATIONS INFORMATION

In continuous mode, the source current of the top MOSFET is a square wave of duty cycle $(V_{OUT})/(V_{IN})$. To prevent large voltage transients, a low ESR capacitor sized for the maximum RMS current of one channel must be used. The maximum RMS capacitor current is given by:

$$C_{IN} \text{ Required } I_{RMS} \approx \frac{I_{MAX}}{V_{IN}} [(V_{OUT})(V_{IN} - V_{OUT})]^{1/2} \quad (1)$$

This formula has a maximum at $V_{IN} = 2V_{OUT}$, where $I_{RMS} = I_{OUT}/2$. This simple worst-case condition is commonly used for design because even significant deviations do not offer much relief. Note that capacitor manufacturers' ripple current ratings are often based on only 2000 hours of life. This makes it advisable to further derate the capacitor, or to choose a capacitor rated at a higher temperature than required. Several capacitors may be paralleled to meet size or height requirements in the design. Due to the high operating frequency of the LTC3859A, ceramic capacitors can also be used for C_{IN} . Always consult the manufacturer if there is any question.

The benefit of the LTC3859A 2-phase operation can be calculated by using Equation (1) for the higher power controller and then calculating the loss that would have resulted if both controller channels switched on at the same time. The total RMS power lost is lower when both controllers are operating due to the reduced overlap of current pulses required through the input capacitor's ESR. This is why the input capacitor's requirement calculated above for the worst-case controller is adequate for the dual controller design. Also, the input protection fuse resistance, battery resistance, and PC board trace resistance losses are also reduced due to the reduced peak currents in a 2-phase system. The overall benefit of a multiphase design will only be fully realized when the source impedance of the power supply/battery is included in the efficiency testing. The drains of the top MOSFETs should be placed within 1cm of each other and share a common C_{IN} (s). Separating the drains and C_{IN} may produce undesirable voltage and current resonances at V_{IN} .

A small (0.1 μ F to 1 μ F) bypass capacitor between the chip V_{IN} pin and ground, placed close to the LTC3859A, is also suggested. A small (1 Ω to 10 Ω) resistor placed between C_{IN} (C1) and the V_{IN} pin provides further isolation between the two channels.

The selection of C_{OUT} is driven by the effective series resistance (ESR). Typically, once the ESR requirement is satisfied, the capacitance is adequate for filtering. The output ripple (ΔV_{OUT}) is approximated by:

$$\Delta V_{OUT} \approx \Delta I_L \left(ESR + \frac{1}{8fC_{OUT}} \right)$$

where f is the operating frequency, C_{OUT} is the output capacitance and ΔI_L is the ripple current in the inductor. The output ripple is highest at maximum input voltage since ΔI_L increases with input voltage.

Setting Output Voltage

The LTC3859A output voltages are each set by an external feedback resistor divider carefully placed across the output, as shown in Figure 5. The regulated output voltages are determined by:

$$V_{OUT, BUCK} = 0.8V \left(1 + \frac{R_B}{R_A} \right)$$

$$V_{OUT, BOOST} = 1.2V \left(1 + \frac{R_B}{R_A} \right)$$

To improve the frequency response, a feedforward capacitor, C_{FF} , may be used. Great care should be taken to route the V_{FB} line away from noise sources, such as the inductor or the SW line.

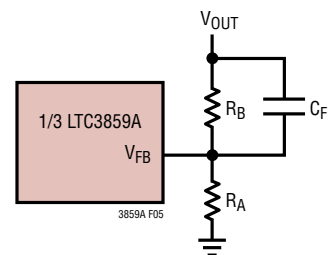

Figure 5. Setting Output Voltage

APPLICATIONS INFORMATION

Tracking and Soft-Start (TRACK/SS1, TRACK/SS2, SS3 Pins)

The start-up of each V_{OUT} is controlled by the voltage on the respective TRACK/SS pin (TRACK/SS1 for channel 1, TRACK/SS2 for channel 2, SS3 for channel 3). When the voltage on the TRACK/SS pin is less than the internal 0.8V reference (1.2V reference for the boost channel), the LTC3859A regulates the V_{FB} pin voltage to the voltage on the TRACK/SS pin instead of the internal reference. Likewise, the TRACK/SS pin for the buck channels can be used to program an external soft-start function or to allow V_{OUT} to track another supply during start-up.

Soft-start is enabled by simply connecting a capacitor from the TRACK/SS pin to ground, as shown in Figure 6. An internal $1\mu\text{A}$ current source charges the capacitor, providing a linear ramping voltage at the TRACK/SS pin. The LTC3859A will regulate the V_{FB} pin (and hence V_{OUT}) according to the voltage on the TRACK/SS pin, allowing V_{OUT} to rise smoothly from 0V to its final regulated value. The total soft-start time will be approximately:

$$t_{SS_BUCK} = C_{SS} \cdot \frac{0.8V}{1\mu A}$$

$$t_{SS_BOOST} = C_{SS} \cdot \frac{1.2V}{1\mu A}$$

Alternatively, the TRACK/SS1 and TRACK/SS2 pins for the two buck controllers can be used to track two (or more) supplies during start-up, as shown qualitatively in Figure 7a and Figure 7b. To do this, a resistor divider should be connected from the master supply (V_X) to the TRACK/SS pin of the slave supply (V_{OUT}), as shown in Figure 8. During start-up V_{OUT} will track V_X according to the ratio set by the resistor divider:

$$\frac{V_X}{V_{OUT}} = \frac{R_A}{R_{TRACKA}} \cdot \frac{R_{TRACKA} + R_{TRACKB}}{R_A + R_B}$$

For coincident tracking ($V_{OUT} = V_X$ during start-up),

$$R_A = R_{TRACKA}$$

$$R_B = R_{TRACKB}$$

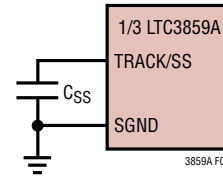
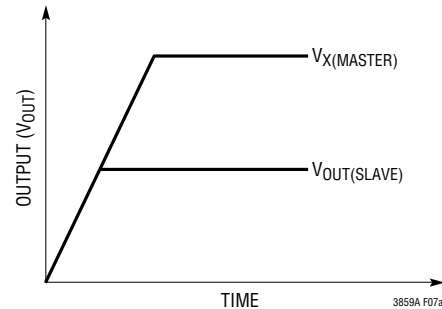
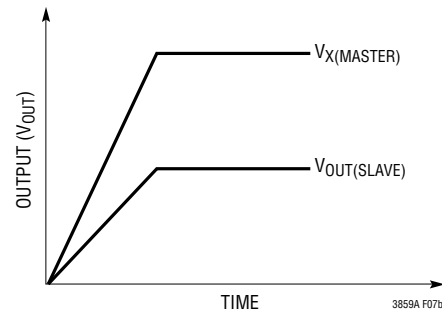

Figure 6. Using the TRACK/SS Pin to Program Soft-Start



7a. Coincident Tracking



7b. Ratiometric Tracking

Figure 7. Two Different Modes of Output Voltage Tracking

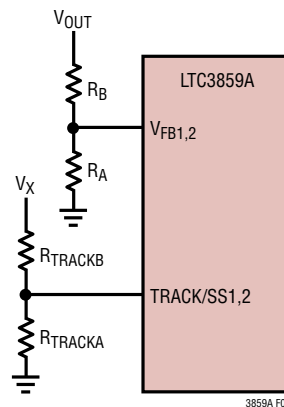

Figure 8. Using the TRACK/SS Pin for Tracking

APPLICATIONS INFORMATION

INTV_{CC} Regulators

The LTC3859A features two separate internal P-channel low dropout linear regulators (LDO) that supply power at the INTV_{CC} pin from either the V_{BIAS} supply pin or the EXTV_{CC} pin depending on the connection of the EXTV_{CC} pin. INTV_{CC} powers the gate drivers and much of the LTC3859A's internal circuitry. The V_{BIAS} LDO and the EXTV_{CC} LDO regulate INTV_{CC} to 5.4V. Each of these must be bypassed to ground with a minimum of 4.7μF ceramic capacitor. No matter what type of bulk capacitor is used, an additional 1μF ceramic capacitor placed directly adjacent to the INTV_{CC} and PGND IC pins is highly recommended. Good bypassing is needed to supply the high transient currents required by the MOSFET gate drivers and to prevent interaction between the channels.

High input voltage applications in which large MOSFETs are being driven at high frequencies may cause the maximum junction temperature rating for the LTC3859A to be exceeded. The INTV_{CC} current, which is dominated by the gate charge current, may be supplied by either the V_{BIAS} LDO or the EXTV_{CC} LDO. When the voltage on the EXTV_{CC} pin is less than 4.7V, the V_{BIAS} LDO is enabled. Power dissipation for the IC in this case is highest and is equal to V_{BIAS} • I_{INTVCC}. The gate charge current is dependent on operating frequency as discussed in the Efficiency Considerations section. The junction temperature can be estimated by using the equations given in Note 2 of the Electrical Characteristics. For example, the LTC3859A INTV_{CC} current is limited to less than 40mA from a 40V supply when not using the EXTV_{CC} supply at a 70°C ambient temperature in the QFN package:

$$T_J = 70^\circ\text{C} + (40\text{mA})(40\text{V})(34^\circ\text{C}/\text{W}) = 125^\circ\text{C}$$

To prevent the maximum junction temperature from being exceeded, the input supply current must be checked while operating in continuous conduction mode (PLLIN/MODE = INTV_{CC}) at maximum V_{IN}.

When the voltage applied to EXTV_{CC} rises above 4.7V, the V_{BIAS} LDO is turned off and the EXTV_{CC} LDO is enabled. The EXTV_{CC} LDO remains on as long as the voltage applied to EXTV_{CC} remains above 4.5V. The EXTV_{CC} LDO attempts to regulate the INTV_{CC} voltage to 5.4V, so while EXTV_{CC} is less than 5.4V, the LDO is in dropout and the INTV_{CC} voltage is approximately equal to EXTV_{CC}. When EXTV_{CC} is greater than 5.4V, up to an absolute maximum of 14V, INTV_{CC} is regulated to 5.4V.

Using the EXTV_{CC} LDO allows the MOSFET driver and control power to be derived from one of the LTC3859A's switching regulator outputs (4.7V ≤ V_{OUT} ≤ 14V) during normal operation and from the V_{BIAS} LDO when the output is out of regulation (e.g., startup, short-circuit). If more current is required through the EXTV_{CC} LDO than is specified, an external Schottky diode can be added between the EXTV_{CC} and INTV_{CC} pins. In this case, do not apply more than 6V to the EXTV_{CC} pin and make sure that EXTV_{CC} ≤ V_{BIAS}.

Significant efficiency and thermal gains can be realized by powering INTV_{CC} from the buck output, since the V_{IN} current resulting from the driver and control currents will be scaled by a factor of (Duty Cycle)/(Switcher Efficiency). For 5V to 14V regulator outputs, this means connecting the EXTV_{CC} pin directly to V_{OUT}. Tying the EXTV_{CC} pin to a 8.5V supply reduces the junction temperature in the previous example from 125°C to:

$$T_J = 70^\circ\text{C} + (40\text{mA})(8.5\text{V})(34^\circ\text{C}/\text{W}) = 82^\circ\text{C}$$

However, for 3.3V and other low voltage outputs, additional circuitry is required to derive INTV_{CC} power from the output.

APPLICATIONS INFORMATION

The following list summarizes the four possible connections for $EXTV_{CC}$:

1. $EXTV_{CC}$ grounded. This will cause $INTV_{CC}$ to be powered from the internal 5.4V regulator resulting in an efficiency penalty of up to 10% at high input voltages.
2. $EXTV_{CC}$ connected directly to the output voltage of one of the buck regulators. This is the normal connection for a 5V to 14V regulator and provides the highest efficiency.
3. $EXTV_{CC}$ connected to an external supply. If an external supply is available in the 5V to 14V range, it may be used to power $EXTV_{CC}$ providing it is compatible with the MOSFET gate drive requirements. Ensure that $EXTV_{CC} < V_{BIAS}$.
4. $EXTV_{CC}$ connected to an output-derived boost network off one of the buck regulators. For 3.3V and other low voltage buck regulators, efficiency gains can still be realized by connecting $EXTV_{CC}$ to an output-derived voltage that has been boosted to greater than 4.7V. This can be done with the capacitive charge pump shown in Figure 9. Ensure that $EXTV_{CC} < V_{BIAS}$.

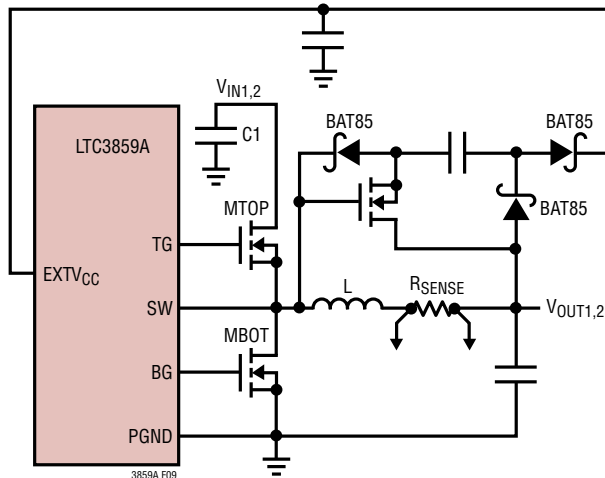

Figure 9. Capacitive Charge Pump for $EXTV_{CC}$

APPLICATIONS INFORMATION

Topside MOSFET Driver Supply (C_B , D_B)

External bootstrap capacitors C_B connected to the BOOST pins supply the gate drive voltages for the topside MOSFETs. Capacitor C_B in the Functional Diagram is charged through external diode D_B from $INTV_{CC}$ when the SW pin is low. When one of the topside MOSFETs is to be turned on, the driver places the C_B voltage across the gate-source of the desired MOSFET. This enhances the MOSFET and turns on the topside switch. The switch node voltage, SW, rises to V_{IN} for the buck channels (V_{OUT} for the boost channel) and the BOOST pin follows. With the topside MOSFET on, the boost voltage is above the input supply: $V_{BOOST} = V_{IN} + V_{INTV_{CC}}$ ($V_{BOOST} = V_{OUT} + V_{INTV_{CC}}$ for the boost controller). The value of the boost capacitor C_B needs to be 100 times that of the total input capacitance of the topside MOSFET(s). The reverse breakdown of the external Schottky diode must be greater than $V_{IN(MAX)}$ for the buck channels and $V_{OUT(MAX)}$ for the boost channel.

The external diode D_B can be a Schottky diode or silicon diode, but in either case it should have low leakage and fast recovery. Pay close attention to the reverse leakage at high temperatures where it generally increases substantially.

The topside MOSFET driver for the boost channel includes an internal charge pump that delivers current to the bootstrap capacitor from the BOOST3 pin. This charge current maintains the bias voltage required to keep the

top MOSFET on continuously during dropout/overvoltage conditions. The Schottky/silicon diode selected for the boost topside driver should have a reverse leakage less than the available output current the charge pump can supply. Curves displaying the available charge pump current under different operating conditions can be found in the Typical Performance Characteristics section.

A leaky diode D_B in the boost converter can not only prevent the top MOSFET from fully turning on but it can also completely discharge the bootstrap capacitor C_B and create a current path from the input voltage to the BOOST3 pin to $INTV_{CC}$. This can cause $INTV_{CC}$ to rise if the diode leakage exceeds the current consumption on $INTV_{CC}$. This is particularly a concern in Burst Mode operation where the load on $INTV_{CC}$ can be very small. There is an internal voltage clamp on $INTV_{CC}$ that prevents the $INTV_{CC}$ voltage from running away, but this clamp should be regarded as a failsafe only. The external Schottky or silicon diode should be carefully chosen such that $INTV_{CC}$ never gets charged up much higher than its normal regulation voltage.

Care should also be taken when choosing the external diode D_B for the buck converters. A leaky diode not only increases the quiescent current of the buck converter, but it can also cause a similar leakage path to $INTV_{CC}$ from V_{OUT} for applications with output voltages greater than the $INTV_{CC}$ voltage (~5.4V).

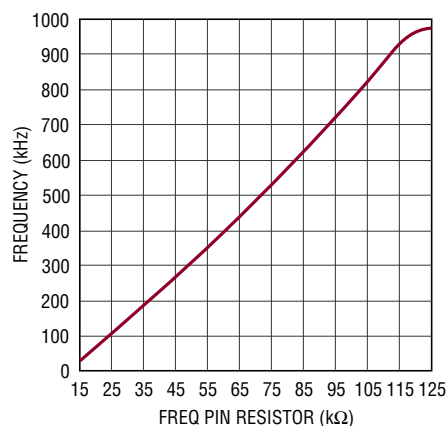

3859A F10

Figure 10. Relationship Between Oscillator Frequency and Resistor Value at the FREQ Pin

APPLICATIONS INFORMATION

Fault Conditions: Buck Current Limit and Current Foldback

The LTC3859A includes current foldback for the buck channels to help limit load current when the output is shorted to ground. If the buck output falls below 70% of its nominal output level, then the maximum sense voltage is progressively lowered from 100% to 40% of its maximum selected value. Under short-circuit conditions with very low duty cycles, the buck channel will begin cycle skipping in order to limit the short-circuit current. In this situation the bottom MOSFET will be dissipating most of the power but less than in normal operation. The short-circuit ripple current is determined by the minimum on-time $t_{ON(MIN)}$ of the LTC3859A ($\approx 95\text{ns}$), the input voltage and inductor value:

$$\Delta I_{L(SC)} = t_{ON(MIN)} (V_{IN}/L)$$

The resulting average short-circuit current is:

$$I_{SC} = 40\% \cdot I_{LIM(MAX)} - \frac{1}{2} \Delta I_{L(SC)}$$

Fault Conditions: Buck Overvoltage Protection (Crowbar)

The overvoltage crowbar is designed to blow a system input fuse when the output voltage of the one of the buck regulators rises much higher than nominal levels. The crowbar causes huge currents to flow, that blow the fuse to protect against a shorted top MOSFET if the short occurs while the controller is operating.

A comparator monitors the buck output for overvoltage conditions. The comparator detects faults greater than 10% above the nominal output voltage. When this condition is sensed, the top MOSFET of the buck controller is turned off and the bottom MOSFET is turned on until the overvoltage condition is cleared. The bottom MOSFET remains on continuously for as long as the overvoltage condition persists; if V_{OUT} returns to a safe level, normal operation automatically resumes.

A shorted top MOSFET for the buck channel will result in a high current condition which will open the system fuse. The switching regulator will regulate properly with a leaky top MOSFET by altering the duty cycle to accommodate the leakage.

Fault Conditions: Over Temperature Protection

At higher temperatures, or in cases where the internal power dissipation causes excessive self heating on chip (such as $INTV_{CC}$ short to ground), the over temperature shutdown circuitry will shut down the LTC3859A. When the junction temperature exceeds approximately 170°C , the over temperature circuitry disables the $INTV_{CC}$ LDO, causing the $INTV_{CC}$ supply to collapse and effectively shutting down the entire LTC3859A chip. Once the junction temperature drops back to approximately 155°C , the $INTV_{CC}$ LDO turns back on. Long term overstress ($T_J > 125^{\circ}\text{C}$) should be avoided as it can degrade the performance or shorten the life of the part.

Phase-Locked Loop and Frequency Synchronization

The LTC3859A has an internal phase-locked loop (PLL) comprised of a phase frequency detector, a lowpass filter, and a voltage-controlled oscillator (VCO). This allows the turn-on of the top MOSFET of controller 1 to be locked to the rising edge of an external clock signal applied to the $PLLIN/MODE$ pin. The turn-on of controller 2's top MOSFET is thus 180 degrees out of phase with the external clock. The phase detector is an edge sensitive digital type that provides zero degrees phase shift between the external and internal oscillators. This type of phase detector does not exhibit false lock to harmonics of the external clock.

If the external clock frequency is greater than the internal oscillator's frequency, f_{OSC} , then current is sourced continuously from the phase detector output, pulling up the VCO input. When the external clock frequency is less than f_{OSC} , current is sunk continuously, pulling down the VCO input.

APPLICATIONS INFORMATION

If the external and internal frequencies are the same but exhibit a phase difference, the current sources turn on for an amount of time corresponding to the phase difference. The voltage at the VCO input is adjusted until the phase and frequency of the internal and external oscillators are identical. At the stable operating point, the phase detector output is high impedance and the internal filter capacitor, CLP, holds the voltage at the VCO input.

Note that the LTC3859A can only be synchronized to an external clock whose frequency is within range of the LTC3859A's internal VCO, which is nominally 55kHz to 1MHz. This is guaranteed to be between 75kHz and 850kHz.

Typically, the external clock (on PLLIN/MODE pin) input high threshold is 1.6V, while the input low threshold is 1.2V.

Rapid phase-locking can be achieved by using the FREQ pin to set a free-running frequency near the desired synchronization frequency. The VCO's input voltage is prebiased at a frequency correspond to the frequency set by the FREQ pin. Once prebiased, the PLL only needs to adjust the frequency slightly to achieve phase-lock and synchronization. Although it is not required that the free-running frequency be near external clock frequency, doing so will prevent the operating frequency from passing through a large range of frequencies as the PLL locks.

Table 1 summarizes the different states in which the FREQ pin can be used.

Table 1.

FREQ PIN	PLLIN/MODE PIN	FREQUENCY
0V	DC Voltage	350kHz
INTV _{CC}	DC Voltage	535kHz
Resistor to SGND	DC Voltage	50kHz to 900kHz
Any of the Above	External Clock	Phase-Locked to External Clock

Minimum On-Time Considerations

Minimum on-time $t_{ON(MIN)}$ is the smallest time duration that the LTC3859A is capable of turning on the top MOSFET (bottom MOSFET for the boost controller). It is determined by internal timing delays and the gate charge required to turn on the top MOSFET. Low duty cycle applications may approach this minimum on-time limit and care should be taken to ensure that

$$t_{ON(MIN)_BUCK} < \frac{V_{OUT}}{V_{IN}(f)}$$

$$t_{ON(MIN)_BOOST} < \frac{V_{OUT} - V_{IN}}{V_{OUT}(f)}$$

If the duty cycle falls below what can be accommodated by the minimum on-time, the controller will begin to skip cycles. The output voltage will continue to be regulated, but the ripple voltage and current will increase.

The minimum on-time for the LTC3859A is approximately 95ns for the bucks and 120ns for the boost. However, as the peak sense voltage decreases the minimum on-time gradually increases up to about 130ns. This is of particular concern in forced continuous applications with low ripple current at light loads. If the duty cycle drops below the minimum on-time limit in this situation, a significant amount of cycle skipping can occur with correspondingly larger current and voltage ripple.

APPLICATIONS INFORMATION

Efficiency Considerations

The percent efficiency of a switching regulator is equal to the output power divided by the input power times 100%. It is often useful to analyze individual losses to determine what is limiting the efficiency and which change would produce the most improvement. Percent efficiency can be expressed as:

$$\% \text{Efficiency} = 100\% - (L1 + L2 + L3 + \dots)$$

where L1, L2, etc. are the individual losses as a percentage of input power.

Although all dissipative elements in the circuit produce losses, four main sources usually account for most of the losses in LTC3859A circuits: 1) IC V_{BIAS} current, 2) INTV_{CC} regulator current, 3) I^2R losses, 4) Topside MOSFET transition losses.

1. The V_{BIAS} current is the DC supply current given in the Electrical Characteristics table, which excludes MOSFET driver and control currents. V_{BIAS} current typically results in a small ($<0.1\%$) loss.
2. INTV_{CC} current is the sum of the MOSFET driver and control currents. The MOSFET driver current results from switching the gate capacitance of the power MOSFETs. Each time a MOSFET gate is switched from low to high to low again, a packet of charge, dQ , moves from INTV_{CC} to ground. The resulting dQ/dt is a current out of INTV_{CC} that is typically much larger than the control circuit current. In continuous mode, $I_{\text{GATECHG}} = f(Q_T + Q_B)$, where Q_T and Q_B are the gate charges of the topside and bottom side MOSFETs.

Supplying INTV_{CC} from an output-derived source power through EXTV_{CC} will scale the V_{IN} current required for the driver and control circuits by a factor of (Duty Cycle)/(Efficiency). For example, in a 20V to 5V application, 10mA of INTV_{CC} current results in approximately 2.5mA of V_{IN} current. This reduces the mid-current loss from 10% or more (if the driver was powered directly from V_{IN}) to only a few percent.

3. I^2R losses are predicted from the DC resistances of the fuse (if used), MOSFET, inductor, current sense resistor, and input and output capacitor ESR. In continuous mode the average output current flows through L and R_{SENSE} , but is “chopped” between the topside MOSFET and the synchronous MOSFET. If the two MOSFETs have approximately the same $R_{\text{DS(ON)}}$, then the resistance of one MOSFET can simply be summed with the resistances of L, R_{SENSE} and ESR to obtain I^2R losses. For example, if each $R_{\text{DS(ON)}} = 30\text{m}\Omega$, $R_L = 50\text{m}\Omega$, $R_{\text{SENSE}} = 10\text{m}\Omega$ and $R_{\text{ESR}} = 40\text{m}\Omega$ (sum of both input and output capacitance losses), then the total resistance is $130\text{m}\Omega$. This results in losses ranging from 3% to 13% as the output current increases from 1A to 5A for a 5V output, or a 4% to 20% loss for a 3.3V output. Efficiency varies as the inverse square of V_{OUT} for the same external components and output power level. The combined effects of increasingly lower output voltages and higher currents required by high performance digital systems is not doubling but quadrupling the importance of loss terms in the switching regulator system!
4. Transition losses apply only to the top MOSFET(s) (bottom MOSFET for the boost), and become significant only when operating at high input voltages (typically 15V or greater). Transition losses can be estimated from:

$$\text{Transition Loss} = (1.7)V_{\text{IN}}^2 \cdot I_{\text{O(MAX)}} \cdot C_{\text{RSS}} \cdot f$$

Other hidden losses such as copper trace and internal battery resistances can account for an additional 5% to 10% efficiency degradation in portable systems. It is very important to include these “system” level losses during the design phase. The internal battery and fuse resistance losses can be minimized by making sure that C_{IN} has adequate charge storage and very low ESR at the switching frequency. A 25W supply will typically require a minimum of 20 μF to 40 μF of capacitance having a maximum of 20m Ω to 50m Ω of ESR. The LTC3859A 2-phase architecture typically halves this input capacitance requirement over competing solutions. Other losses including Schottky conduction losses during dead-time and inductor core losses generally account for less than 2% total additional loss.

APPLICATIONS INFORMATION

Checking Transient Response

The regulator loop response can be checked by looking at the load current transient response. Switching regulators take several cycles to respond to a step in DC (resistive) load current. When a load step occurs, V_{OUT} shifts by an amount equal to $\Delta I_{LOAD}(ESR)$, where ESR is the effective series resistance of C_{OUT} . ΔI_{LOAD} also begins to charge or discharge C_{OUT} generating the feedback error signal that forces the regulator to adapt to the current change and return V_{OUT} to its steady-state value. During this recovery time V_{OUT} can be monitored for excessive overshoot or ringing, which would indicate a stability problem. OPTI-LOOP compensation allows the transient response to be optimized over a wide range of output capacitance and ESR values. The availability of the I_{TH} pin not only allows optimization of control loop behavior, but it also provides a DC coupled and AC filtered closed loop response test point. The DC step, rise time and settling at this test point truly reflects the closed loop response. Assuming a predominantly second order system, phase margin and/or damping factor can be estimated using the percentage of overshoot seen at this pin. The bandwidth can also be estimated by examining the rise time at the pin. The I_{TH} external components shown in Figure 15 will provide an adequate starting point for most applications.

The I_{TH} series RC-CC filter sets the dominant pole-zero loop compensation. The values can be modified slightly (from 0.5 to 2 times their suggested values) to optimize transient response once the final PC layout is done and the particular output capacitor type and value have been determined. The output capacitors need to be selected because the various types and values determine the loop gain and phase. An output current pulse of 20% to 80% of full-load current having a rise time of 1 μ s to 10 μ s will produce output voltage and I_{TH} pin waveforms that will give a sense of the overall loop stability without breaking the feedback loop.

Placing a power MOSFET directly across the output capacitor and driving the gate with an appropriate signal generator is a practical way to produce a realistic load step condition. The initial output voltage step resulting from the step change in output current may not be within the bandwidth of the feedback loop, so this signal cannot be

used to determine phase margin. This is why it is better to look at the I_{TH} pin signal which is in the feedback loop and is the filtered and compensated control loop response.

The gain of the loop will be increased by increasing RC and the bandwidth of the loop will be increased by decreasing CC. If RC is increased by the same factor that CC is decreased, the zero frequency will be kept the same, thereby keeping the phase shift the same in the most critical frequency range of the feedback loop. The output voltage settling behavior is related to the stability of the closed-loop system and will demonstrate the actual overall supply performance.

A second, more severe transient is caused by switching in loads with large (>1 μ F) supply bypass capacitors. The discharged bypass capacitors are effectively put in parallel with C_{OUT} , causing a rapid drop in V_{OUT} . No regulator can alter its delivery of current quickly enough to prevent this sudden step change in output voltage if the load switch resistance is low and it is driven quickly. If the ratio of C_{LOAD} to C_{OUT} is greater than 1:50, the switch rise time should be controlled so that the load rise time is limited to approximately $25 \cdot C_{LOAD}$. Thus a 10 μ F capacitor would require a 250 μ s rise time, limiting the charging current to about 200mA.

Buck Design Example

As a design example for one of the buck channels channel, assume $V_{IN} = 12V_{(NOMINAL)}$, $V_{IN} = 22V_{(MAX)}$, $V_{OUT} = 3.3V$, $I_{MAX} = 6A$, $V_{SENSE(MAX)} = 50mV$, and $f = 350kHz$.

The inductance value is chosen first based on a 30% ripple current assumption. The highest value of ripple current occurs at the maximum input voltage. Tie the FREQ pin to GND, generating 350kHz operation. The minimum inductance for 30% ripple current is:

$$\Delta I_L = \frac{V_{OUT}}{(f)(L)} \left(1 - \frac{V_{OUT}}{V_{IN(NOMINAL)}} \right)$$

A 3.9 μ H inductor will produce 29% ripple current. The peak inductor current will be the maximum DC value plus one half the ripple current, or 6.88A. Increasing the ripple current will also help ensure that the minimum on-time

APPLICATIONS INFORMATION

of 95ns is not violated. The minimum on-time occurs at maximum V_{IN} :

$$t_{ON(MIN)} = \frac{V_{OUT}}{V_{IN(MAX)}(f)} = \frac{3.3V}{22V(350kHz)} = 429ns$$

The R_{SENSE} resistor value can be calculated by using the minimum value for the maximum current sense threshold (43mV):

$$R_{SENSE} \leq \frac{43mV}{6.88A} = 0.006\Omega$$

Choosing 1% resistors: $R_A = 25k$ and $R_B = 80.6k$ yields an output voltage of 3.33V.

The power dissipation on the top side MOSFET can be easily estimated. Choosing a Fairchild FDS6982S dual MOSFET results in: $R_{DS(ON)} = 0.035\Omega/0.022\Omega$, $C_{MILLER} = 215pF$. At maximum input voltage with $T(\text{estimated}) = 50^\circ C$:

$$P_{MAIN} = \frac{3.3V}{22V} (6A)^2 \left\{ 1 + (0.005)(50^\circ C - 25^\circ C) \right\}$$

$$(0.035\Omega) + (22V)^2 6 \frac{5A}{2} (2.5\Omega)(215pF) \cdot$$

$$\left\{ \frac{1}{5V - 2.3V} + \frac{1}{2.3V} \right\} (350kHz) = 433mW$$

A short-circuit to ground will result in a folded back current of:

$$I_{SC} = \frac{20mV}{0.006\Omega} - \frac{1}{2} \left\{ \frac{95ns(22V)}{3.9\mu H} \right\} = 3.07A$$

with a typical value of $R_{DS(ON)}$ and $\zeta = (0.005/^\circ C)(25^\circ C) = 0.125$. The resulting power dissipated in the bottom MOSFET is:

$$P_{SYNC} = (2.23A)^2 (1.125)(0.022\Omega) = 233mW$$

which is less than under full-load conditions.

The input capacitor to the buck regulator C_{IN} is chosen for an RMS current rating of at least 3A at temperature assuming only this channel is on. C_{OUT} is chosen with an ESR of 0.02Ω for low output ripple. The output ripple in continuous mode will be highest at the maximum input voltage. The output voltage ripple due to ESR is approximately:

$$V_{ORIPPLE} = R_{ESR} (\Delta I_L) = 0.02\Omega(1.75A) = 35mV_{P-P}$$

PC Board Layout Checklist

When laying out the printed circuit board, the following checklist should be used to ensure proper operation of the IC. These items are also illustrated graphically in the layout diagram of Figure 11. Figure 12 illustrates the current waveforms present in the various branches of the 2-phase synchronous buck regulators operating in the continuous mode. Check the following in your layout:

1. Are the top N-channel MOSFETs MTOP1 and MTOP2 located within 1cm of each other with a common drain connection at C_{IN} ? Do not attempt to split the input decoupling for the two channels as it can cause a large resonant loop.
2. Are the signal and power grounds kept separate? The combined IC signal ground pin and the ground return of C_{INTVCC} must return to the combined C_{OUT} (-) terminals. The path formed by the top N-channel MOSFET, Schottky diode and the C_{IN} capacitor should have short leads and PC trace lengths. The output capacitor (-) terminals should be connected as close as possible to the (-) terminals of the input capacitor by placing the capacitors next to each other and away from the Schottky loop described above.
3. Do the LTC3859A V_{FB} pins' resistive dividers connect to the (+) terminals of C_{OUT} ? The resistive divider must be connected between the (+) terminal of C_{OUT} and signal ground. The feedback resistor connections should not be along the high current input feeds from the input capacitor(s).
4. Are the SENSE⁻ and SENSE⁺ leads routed together with minimum PC trace spacing? The filter capacitor between SENSE⁺ and SENSE⁻ should be as close as possible to the IC. Ensure accurate current sensing with Kelvin connections at the sense resistor.
5. Is the INTV_{CC} decoupling capacitor connected close to the IC, between the INTV_{CC} and the power ground pins? This capacitor carries the MOSFET drivers' current peaks. An additional 1 μ F ceramic capacitor placed immediately next to the INTV_{CC} and PGND pins can help improve noise performance substantially.

APPLICATIONS INFORMATION

6. Keep the switching nodes (SW1, SW2, SW3), top gate nodes (TG1, TG2, TG3), and boost nodes (BOOST1, BOOST2, BOOST3) away from sensitive small-signal nodes, especially from the opposite channel's voltage and current sensing feedback pins. All of these nodes have very large and fast moving signals and therefore should be kept on the output side of the LTC3859A and occupy minimum PC trace area.
7. Use a modified star ground technique: a low impedance, large copper area central grounding point on the same side of the PC board as the input and output capacitors with tie-ins for the bottom of the INTV_{CC} decoupling capacitor, the bottom of the voltage feedback resistive divider and the SGND pin of the IC.

PC Board Layout Debugging

Start with one controller on at a time. It is helpful to use a DC-50MHz current probe to monitor the current in the inductor while testing the circuit. Monitor the output switching node (SW pin) to synchronize the oscilloscope to the internal oscillator and probe the actual output voltage as well. Check for proper performance over the operating voltage and current range expected in the application. The frequency of operation should be maintained over the input voltage range down to dropout and until the output load drops below the low current operation threshold—typically 25% of the maximum designed current level in Burst Mode operation.

The duty cycle percentage should be maintained from cycle to cycle in a well-designed, low noise PCB implementation. Variation in the duty cycle at a subharmonic rate can suggest noise pickup at the current or voltage sensing inputs or inadequate loop compensation. Overcompensation of the loop can be used to tame a poor PC layout if regulator bandwidth optimization is not required. Only after each controller is checked for its individual performance should

both controllers be turned on at the same time. A particularly difficult region of operation is when one controller channel is nearing its current comparator trip point when the other channel is turning on its top MOSFET. This occurs around 50% duty cycle on either channel due to the phasing of the internal clocks and may cause minor duty cycle jitter.

Reduce V_{IN} from its nominal level to verify operation of the regulator in dropout. Check the operation of the undervoltage lockout circuit by further lowering V_{IN} while monitoring the outputs to verify operation.

Investigate whether any problems exist only at higher output currents or only at higher input voltages. If problems coincide with high input voltages and low output currents, look for capacitive coupling between the BOOST, SW, TG, and possibly BG connections and the sensitive voltage and current pins. The capacitor placed across the current sensing pins needs to be placed immediately adjacent to the pins of the IC. This capacitor helps to minimize the effects of differential noise injection due to high frequency capacitive coupling. If problems are encountered with high current output loading at lower input voltages, look for inductive coupling between C_{IN} , Schottky and the top MOSFET components to the sensitive current and voltage sensing traces. In addition, investigate common ground path voltage pickup between these components and the SGND pin of the IC.

An embarrassing problem, which can be missed in an otherwise properly working switching regulator, results when the current sensing leads are hooked up backwards. The output voltage under this improper hookup will still be maintained but the advantages of current mode control will not be realized. Compensation of the voltage loop will be much more sensitive to component selection. This behavior can be investigated by temporarily shorting out the current sensing resistor—don't worry, the regulator will still maintain control of the output voltage.

APPLICATIONS INFORMATION

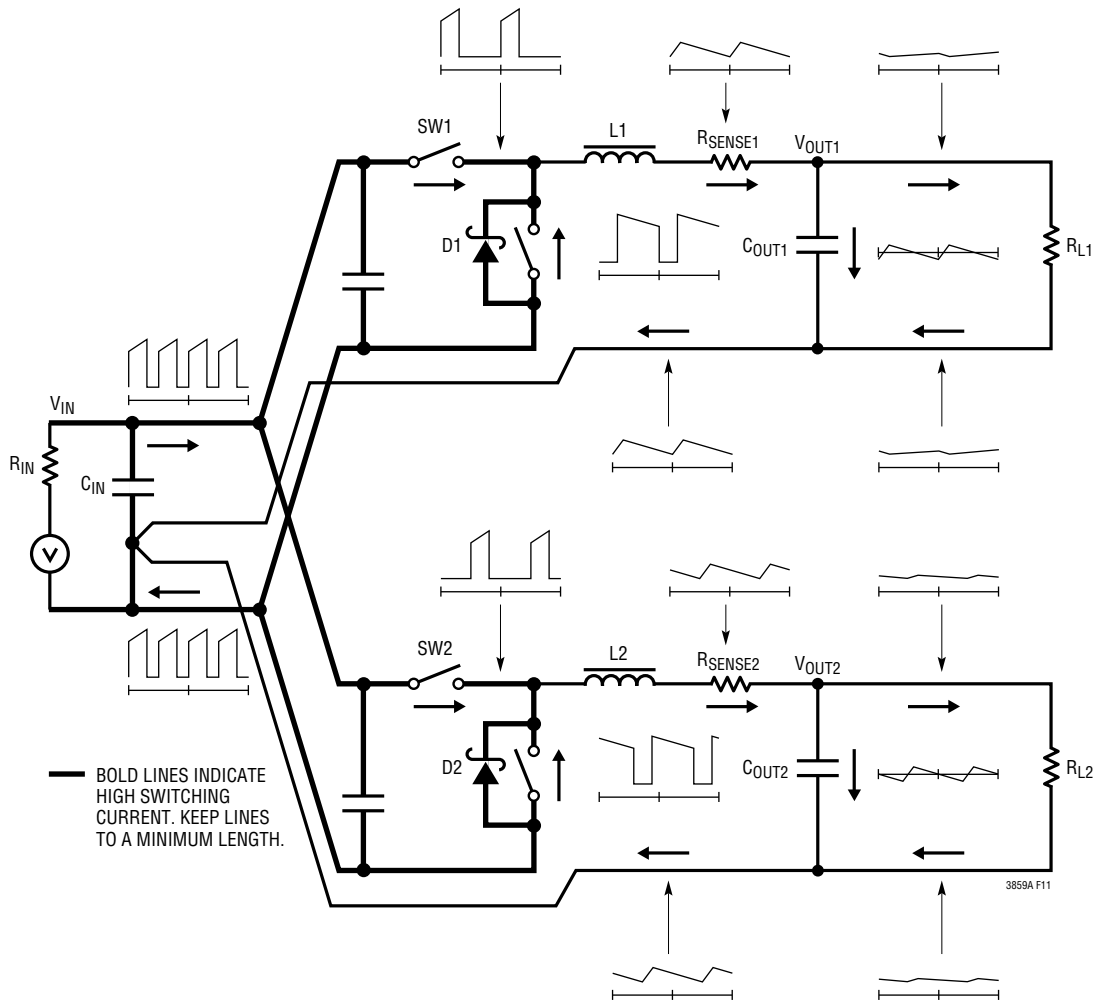

Figure 11. Branch Current Waveforms for Bucks

TYPICAL APPLICATIONS

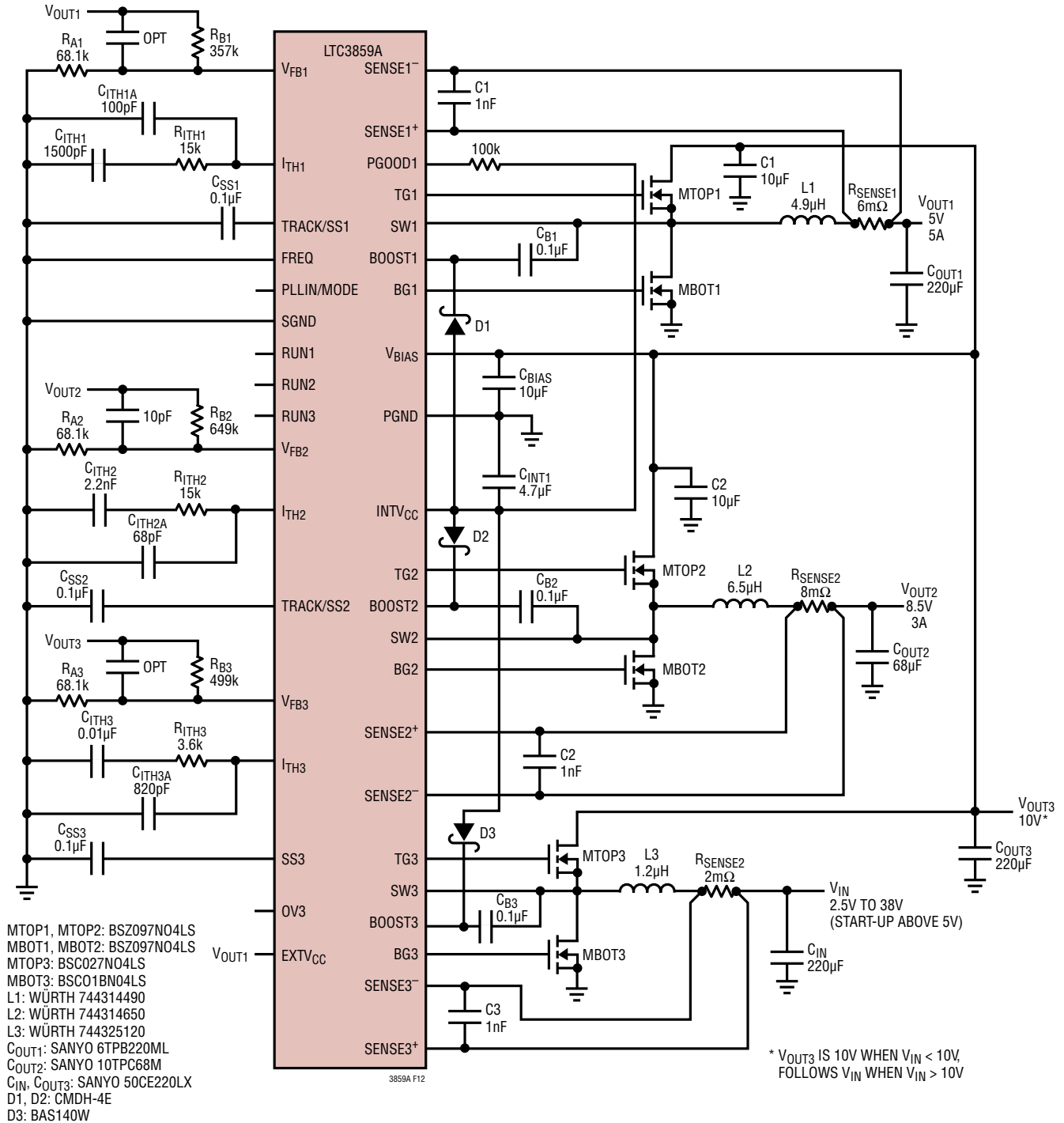

Figure 12. High Efficiency Wide Input Range Dual 5V/8.5V Converter

TYPICAL APPLICATIONS

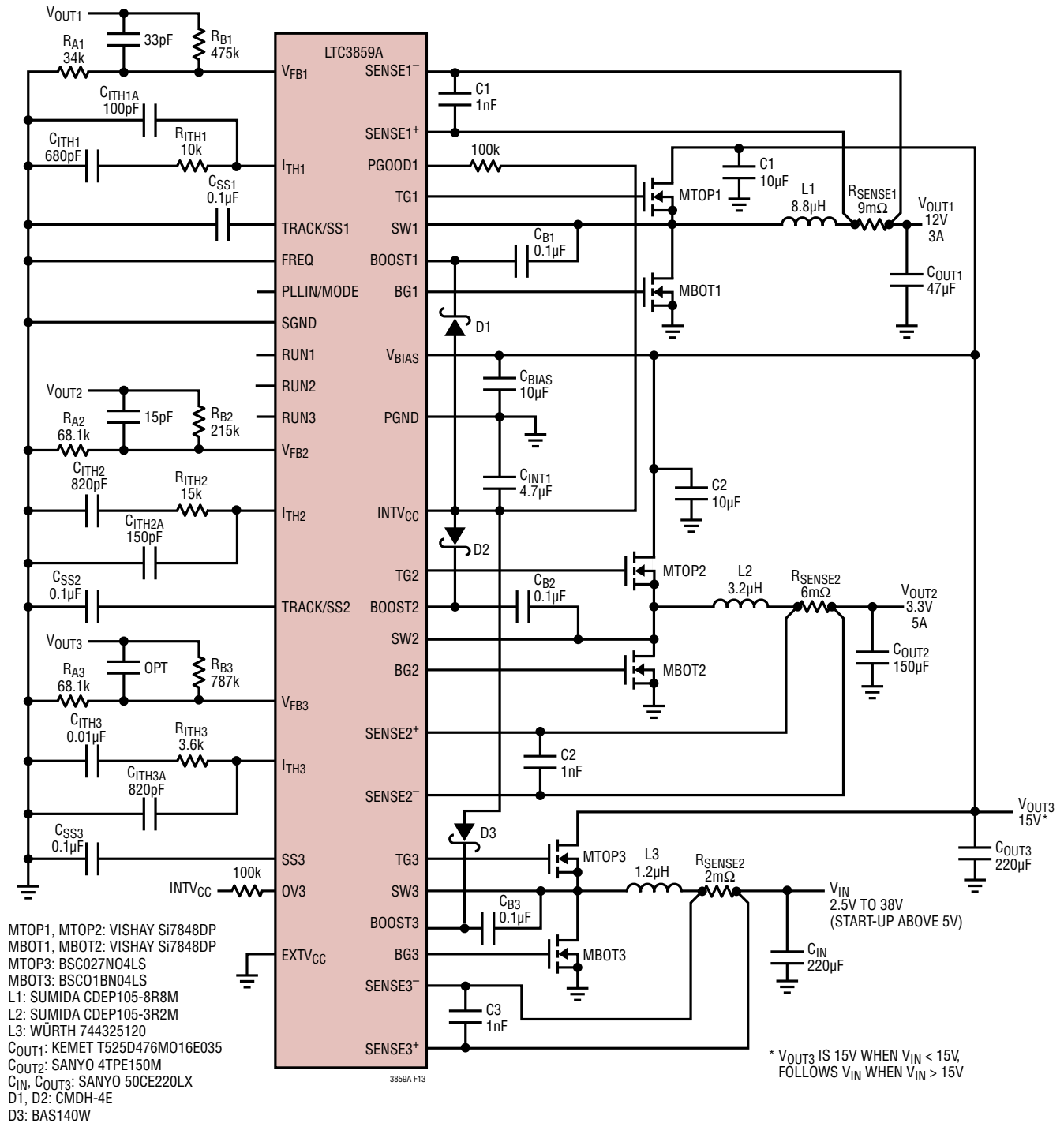

Figure 13. High Efficiency Wide Input Range Dual 12V/3.3V Converter

TYPICAL APPLICATIONS

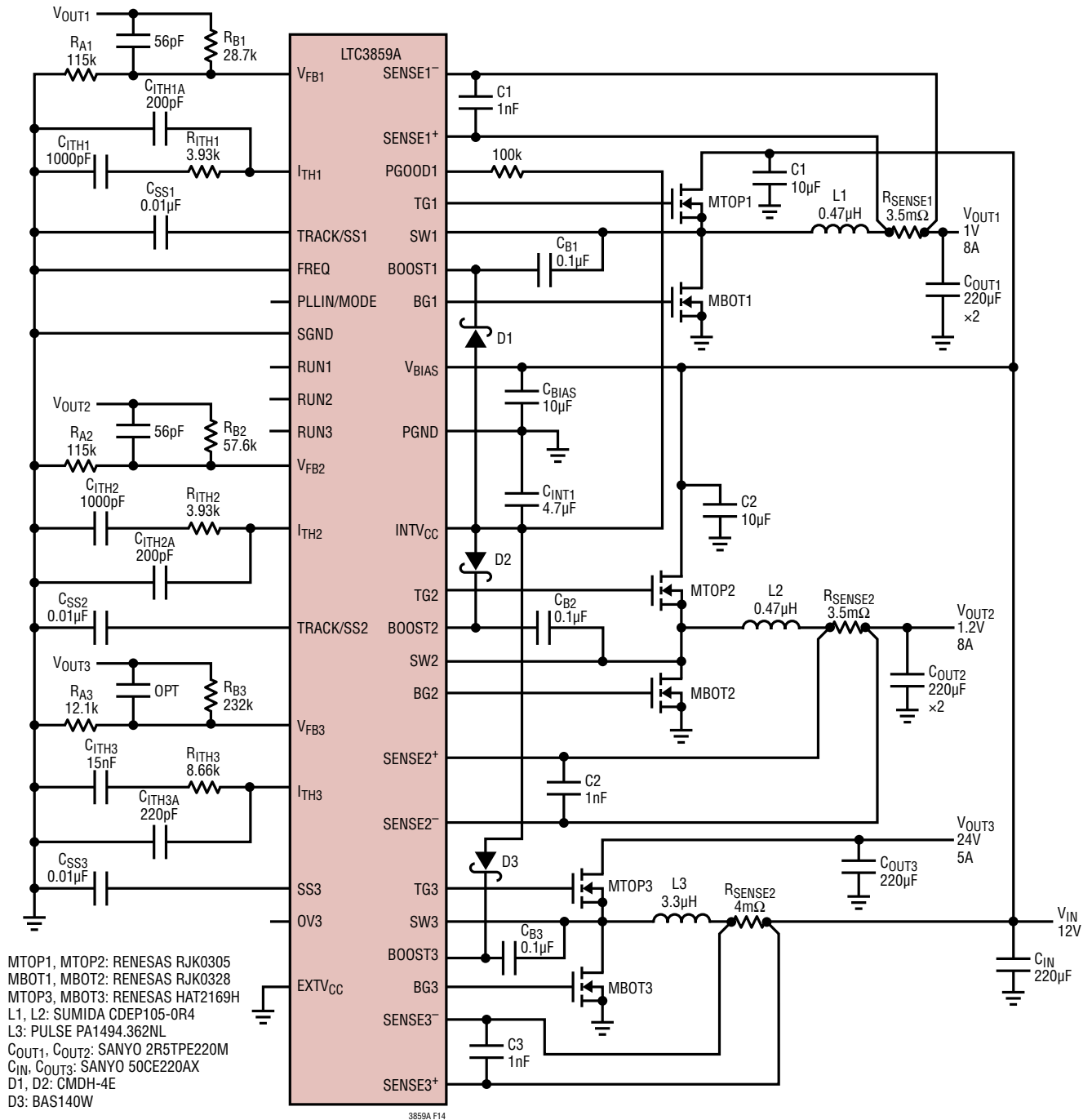

Figure 14. High Efficiency Triple 24V/1V/1.2V Converter from 12V VIN

TYPICAL APPLICATIONS

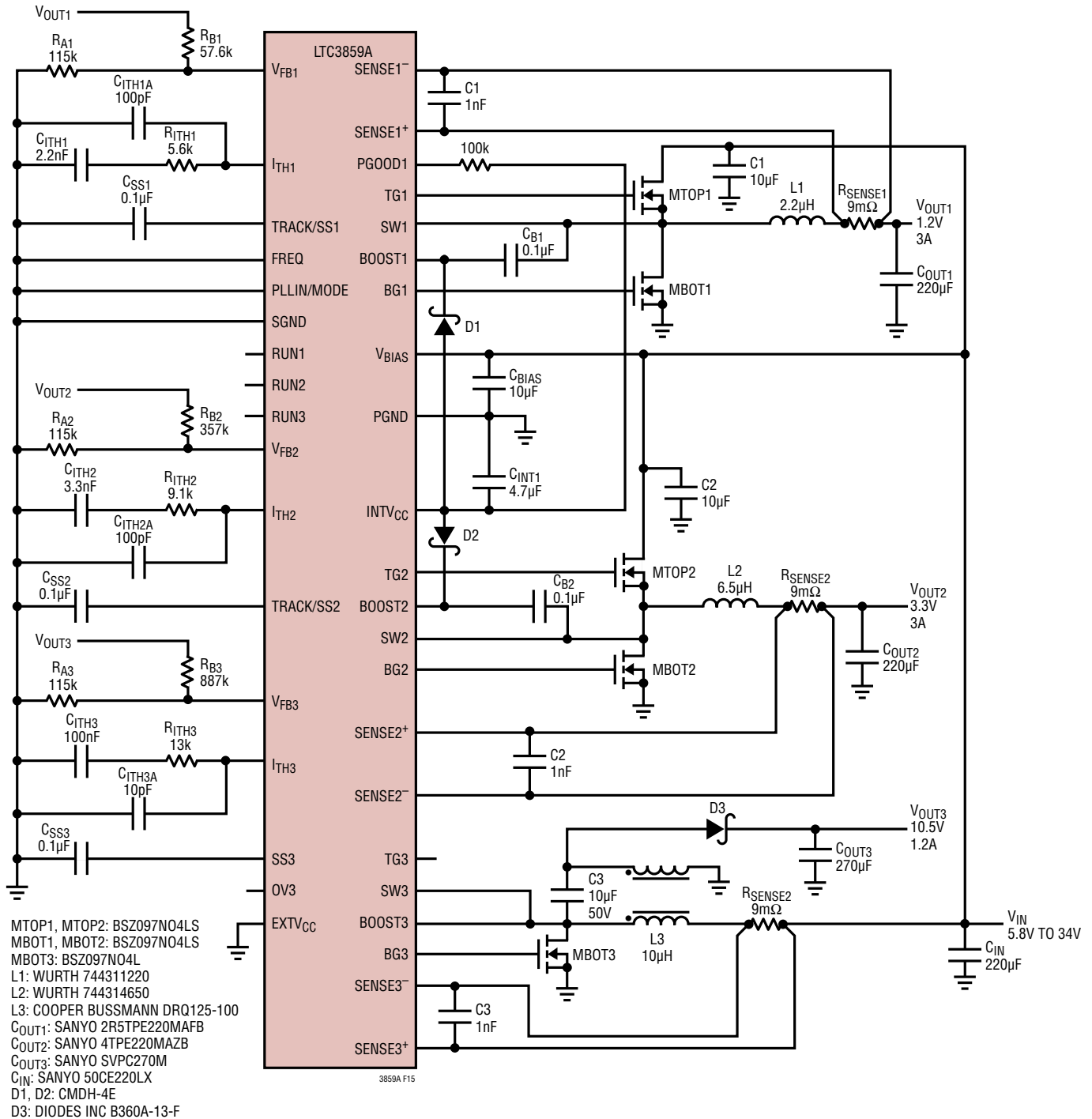
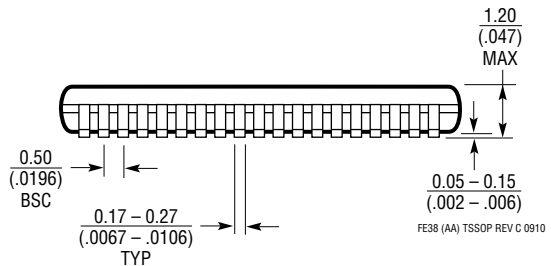
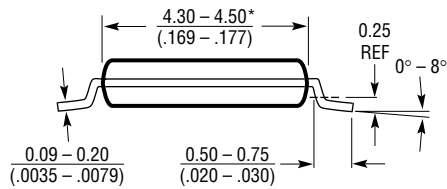
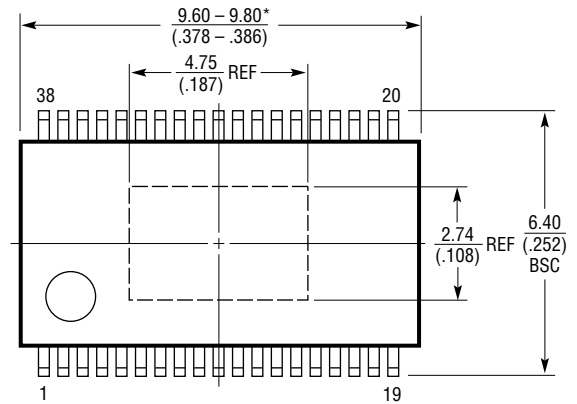
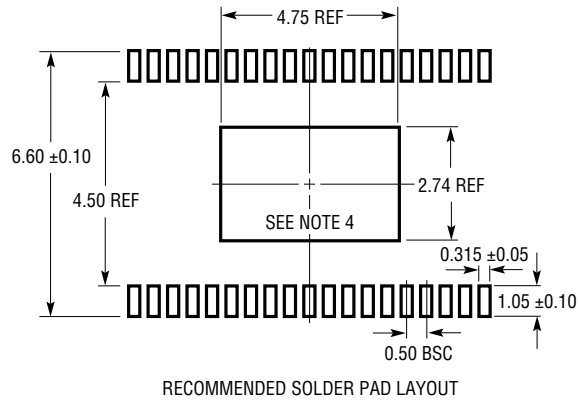

Figure 15. High Efficiency 1.2V/3.3V Step-Down Converter with 10.5V SEPIC Converter

PACKAGE DESCRIPTION

FE Package
38-Lead Plastic TSSOP (4.4mm)
 (Reference LTC DWG # 05-08-1772 Rev C)

Exposed Pad Variation AA



- NOTE:
1. CONTROLLING DIMENSION: MILLIMETERS
 2. DIMENSIONS ARE IN MILLIMETERS (INCHES)
 3. DRAWING NOT TO SCALE
 4. RECOMMENDED MINIMUM PCB METAL SIZE FOR EXPOSED PAD ATTACHMENT
 *DIMENSIONS DO NOT INCLUDE MOLD FLASH. MOLD FLASH SHALL NOT EXCEED 0.15mm (.006") PER SIDE

REVISION HISTORY

REV	DATE	DESCRIPTION	PAGE NUMBER
A	06/16	Block Diagram clarification	13, 14
		Corrected PMAIN_BOOST equation	23
		Modified points #3 and #4	28
		Modified Figure 9	28
B	01/20	Changed Line Regulation Conditions	3
		Minor Block Diagram Changes	13, 14