

Standalone Linear Li-Ion Battery Charger with Micropower Comparator

FEATURES

- Charge Current Programmable Up to 1A
- Charges Single-Cell Li-Ion Batteries Directly from USB Port
- Preset Float Voltage with $\pm 0.35\%$ Accuracy
- Micropower Comparator for Battery Monitoring
- Thermal Regulation Maximizes Charge Rate Without Risk of Overheating
- Programmable Charge Current Detection/Termination
- Programmable Charge Termination Timer
- Smart Pulsing Error Feature
- SmartStart™ Prolongs Battery Life
- 20 μ A Charger Quiescent Current in Shutdown
- Available in a Low Profile (0.75mm) 10-Lead (3mm \times 3mm) DFN Package

APPLICATIONS

- Handheld Computers
- Portable MP3 Players
- Digital Cameras

LT, LT, LTC and LTM are registered trademarks of Linear Technology Corporation. SmartStart is a trademark of Linear Technology Corporation. All other trademarks are the property of their respective owners. Protected by U.S. Patents, including 6522118.

DESCRIPTION

The LTC[®]4062 is a full-featured, flexible, standalone linear charger for single-cell Lithium-Ion batteries. It is capable of operating within USB power specifications.

Both programmable time and programmable current based termination schemes are available. Furthermore, the $\overline{\text{CHRG}}$ open-drain status pin can be programmed to indicate the battery charge state according to the needs of the application. A precise low power comparator is available even with no power applied as long as battery voltage is higher than 2.5V. Additional safety features designed to maximize battery lifetime and reliability include the SmartStart charging algorithm.

No external sense resistor or external blocking diode is required for charging due to the internal MOSFET architecture. Internal thermal feedback regulates the charge current to maintain a constant die temperature during high power operation or high ambient temperature conditions. The charge current is programmed with an external resistor. With power applied, the LTC4062 can be put into shutdown mode to reduce the supply current to 20 μ A and the battery drain current to less than 5 μ A. Without power applied, the internal low power comparator can work sinking only 10 μ A from the battery.

Other features include smart recharge, USB $\overline{\text{C/5}}$ current programming input and undervoltage lockout.

TYPICAL APPLICATION

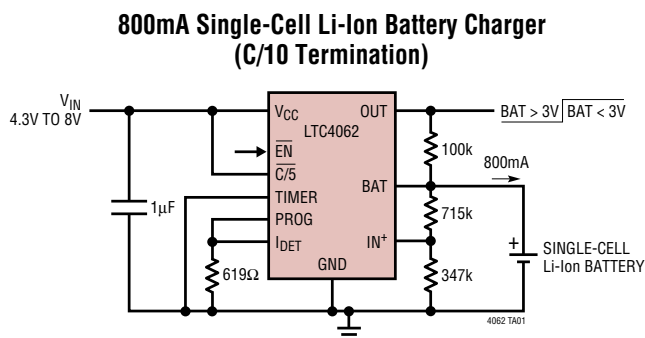

Complete Charge Cycle (1100mAh Battery)

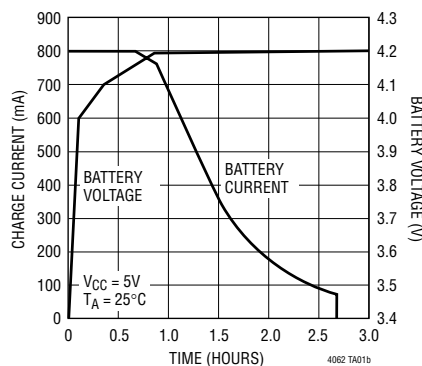

ABSOLUTE MAXIMUM RATINGS

(Note 1)

Input Supply Voltage (V_{CC})	-0.3V to 10V
EN, OUT, CHRG, IN+, PROG, C/5, BAT	-0.3V to 10V
TIMER, I _{DET}	-0.3V to $V_{CC} + 0.3V$
BAT Short-Circuit Duration	Continuous
V_{CC} Pin Current	1A
BAT Pin Current	1A
Maximum Junction Temperature	125°C
Operating Temperature Range (Note 2)	-40°C to 85°C
Storage Temperature Range	-65°C to 125°C

PACKAGE/ORDER INFORMATION

<p>TOP VIEW</p> <p>DD PACKAGE 10-LEAD (3mm × 3mm) PLASTIC DFN $T_{JMAX} = 125^{\circ}C$, $\theta_{JA} = 40^{\circ}C/W$ (NOTE 3) EXPOSED PAD IS GROUND (PIN 11) MUST BE SOLDERED TO PCB</p>	
ORDER PART NUMBER	DD PART MARKING
LTC4062EDD	LBJT
<p>Order Options Tape and Reel: Add #TR Lead Free: Add #PBF Lead Free Tape and Reel: Add #TRPBF Lead Free Part Marking: http://www.linear.com/leadfree/</p>	

Consult LTC Marketing for parts specified with wider operating temperature ranges.

ELECTRICAL CHARACTERISTICS

The ● denotes specifications which apply over the full operating temperature range, otherwise specifications are at $T_A = 25^{\circ}C$, $V_{CC} = 5V$, unless otherwise noted.

SYMBOL	PARAMETER	CONDITIONS	MIN	TYP	MAX	UNITS	
V_{CC}	Input Supply Voltage		●	4.3	8	V	
I_{CC}	Input Supply Current	Charge Mode (Note 4), $R_{PROG} = 10k$ Standby Mode, Charge Terminated Shutdown ($EN = 5V$, $V_{CC} < V_{BAT}$ or $V_{CC} < V_{UV}$)	●	240	500	μA	
			●	130	300	μA	
			●	20	50	μA	
V_{FLOAT}	V_{BAT} Regulated Output Voltage	$0 < T_A < 85^{\circ}C$		4.185 4.175	4.2 4.225	V V	
I_{BAT}	BAT Pin Current	$R_{PROG} = 10k$, Constant Current Mode $R_{PROG} = 1.25k$, Constant Current Mode Standby Mode, Charge Terminated, $V_{BAT} = 4.2V$ Shutdown Mode, $V_{BAT} = 4.2V$	●	93	107	mA	
			●	760	840	mA	
			●	-3.5	-7	μA	
			●	± 1	± 5	μA	
V_{PROG}	PROG Pin Voltage	$R_{PROG} = 10k$, Constant Current Mode $R_{PROG} = 1.25k$, Constant Current Mode		0.97	1.03	V	
				0.97	1.03	V	
V_{OUT}	OUT Output Low Voltage	$I_{OUT} = 5mA$ $I_{OUT} = 5mA$, $V_{CC} = 0V$, $V_{BAT} = 2.55V$		0.10	0.25	V	
				0.16	0.26	V	
V_{CHRG}	CHRG Output Low Voltage	$I_{CHRG} = 5mA$		0.1	0.25	V	
I_{TRIKL}	Trickle Charge Current	$V_{BAT} < V_{TRIKL}$, $R_{PROG} = 10k$ $V_{BAT} < V_{TRIKL}$, $R_{PROG} = 1.25k$		6 60	10 80	mA mA	
V_{TRIKL}	Trickle Charge Threshold Voltage	V_{BAT} Rising Hysteresis		2.8	2.9 100	V mV	
V_{UV}	V_{CC} Undervoltage Lockout Voltage	From Low to High Hysteresis		3.7	3.8 200	V V	
V_{ASD}	$V_{CC} - V_{BAT}$ Lockout Threshold Voltage	V_{CC} from Low to High, $V_{BAT} = 4.3V$ V_{CC} from High to Low, $V_{BAT} = 4.3V$		145 10	190 45	230 75	mV mV
R_{EN}	EN Pin Pull-Down Resistor		●	2	3.4	5	M Ω

ELECTRICAL CHARACTERISTICS

The ● denotes specifications which apply over the full operating temperature range, otherwise specifications are at $T_A = 25^\circ\text{C}$. $V_{CC} = 5\text{V}$, unless otherwise noted.

SYMBOL	PARAMETER	CONDITIONS	MIN	TYP	MAX	UNITS
$V_{\overline{\text{EN}}}$	$\overline{\text{EN}}$ Input Threshold Voltage	$\overline{\text{EN}}$ Rising, $4.3\text{V} < V_{CC} < 8\text{V}$ Hysteresis	0.4	0.7 70	1	V mV
V_{CT}	Charge Termination Mode Threshold Voltage	V_{TIMER} from High to Low Hysteresis	0.4	0.7 50	1	V mV
V_{UT}	User Termination Mode Threshold Voltage	V_{TIMER} from Low to High Hysteresis	3.9	4.2 50		V mV
I_{DETECT}	Charge Current Detection Threshold	$R_{\text{DET}} = 1\text{k}$, $0 \leq T_A \leq 85^\circ\text{C}$ $R_{\text{DET}} = 2\text{k}$, $0 \leq T_A \leq 85^\circ\text{C}$ $R_{\text{DET}} = 10\text{k}$, $0 \leq T_A \leq 85^\circ\text{C}$ $R_{\text{DET}} = 20\text{k}$, $0 \leq T_A \leq 85^\circ\text{C}$	90 45 8 3.8	100 50 10 5	110 55 12 6.2	mA mA mA mA
ΔV_{RECHRG}	Recharge Threshold Voltage	$V_{\text{FLOAT}} - V_{\text{RECHRG}}$, $0 \leq T_A \leq 85^\circ\text{C}$	65	100	135	mV
t_{SS}	Soft-Start Time	I_{BAT} from 0 to I_{CHG}		100		μs
t_{TERM}	Termination Comparator Filter Time	Current Termination Mode	0.8	1.5	2.5	ms
t_{RECHRG}	Recharge Comparator Filter Time		3	7	14	ms
t_{TIMER}	Charge Cycle Time	$C_{\text{TIMER}} = 0.1\mu\text{F}$	2.55	3	3.45	hr
$R_{\overline{\text{C}}/5}$	$\overline{\text{C}}/5$ Pin Pull-Down Resistor		● 2	3.4	5	$\text{M}\Omega$
$V_{\overline{\text{C}}/5}$	$\overline{\text{C}}/5$ Input Threshold Voltage	$\overline{\text{C}}/5$ Rising, $4.3\text{V} < V_{CC} < 8\text{V}$ Hysteresis	0.4	0.7 70	1	V mV
T_{LIM}	Junction Temperature in Constant Temperature Mode			105		$^\circ\text{C}$
R_{ON}	Power FET "ON" Resistance (Between V_{CC} and BAT)	$V_{\text{BAT}} = 3.85\text{V}$, $I_{\text{CC}} = 175\text{mA}$, $R_{\text{PROG}} = 2\text{k}$		375		$\text{m}\Omega$

Comparator

$V_{\text{IN}+}$	$\text{IN}+$ Pin Threshold Voltage	$V_{\text{IN}+}$ Falling Hysteresis	● 0.988	1 50	1.012	V mV
$V_{\text{BAT-MIN}}$	Minimum V_{BAT} Supply Voltage for the Low Power Comparator	$V_{CC} = 0\text{V}$, V_{BAT} Falling Hysteresis	2.4	2.5 100	2.6	V mV
I_{BAT}	Supply Current for the Low Power Comparator	$V_{CC} = 0\text{V}$, $V_{\text{BAT}} = 2.5\text{V}$	7	9	13	μA

Note 1: Stresses beyond those listed under Absolute Maximum Ratings may cause permanent damage to the device. Exposure to any Absolute Maximum Rating condition for extended periods may affect device reliability and lifetime.

Note 2: The LTC4062 is guaranteed to meet performance specifications from 0°C to 70°C . Specifications over the -40°C to 85°C operating temperature range are assured by design, characterization and correlation with statistical process controls.

Note 3: Failure to correctly solder the exposed pad of the package to the PC board will result in a thermal resistance much higher than $40^\circ\text{C}/\text{W}$.

Note 4: Supply current includes PROG pin current and I_{DET} pin current (approximately $100\mu\text{A}$ each) but does not include any current delivered to the battery through the BAT pin (approximately 100mA).

Note 5: This IC includes overtemperature protection that is intended to protect the device during momentary overload conditions. Overtemperature protection will become active at a junction temperature greater than the maximum operating temperature. Continuous operation above the specified maximum operating junction temperature may impair device reliability.

TYPICAL PERFORMANCE CHARACTERISTICS $T_A = 25^\circ\text{C}$ unless otherwise noted.

Battery Regulated Output (Float) Voltage vs Charge Current

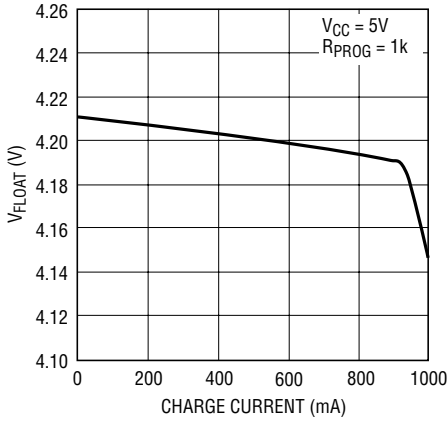

4062 G01

Battery Regulated Output (Float) Voltage vs Temperature

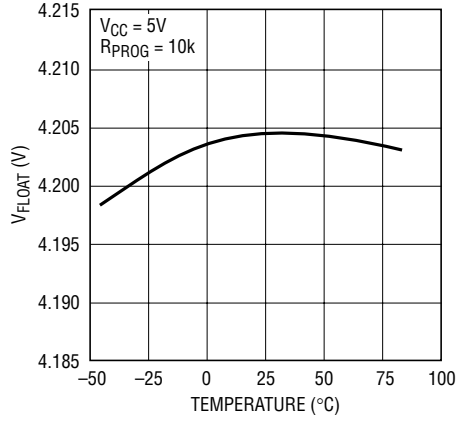

4062 G02

Battery Regulated Output (Float) Voltage vs Supply Voltage

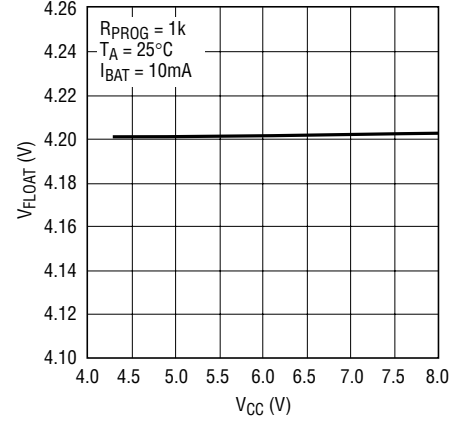

4062 G03

Charge Current vs PROG Pin Voltage

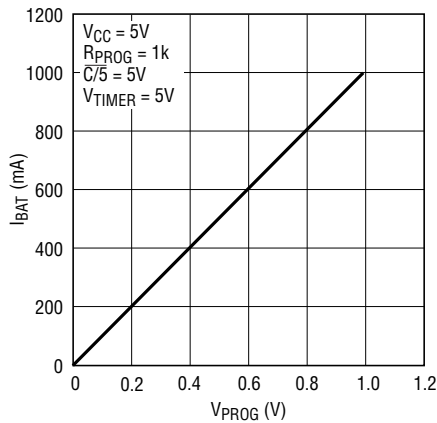

4062 G04

PROG Pin Voltage vs Temperature (Constant-Current Mode)

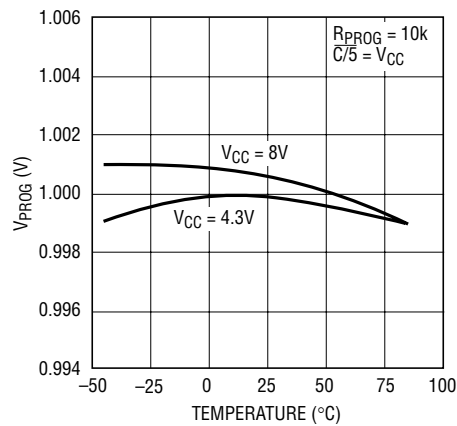

4062 G05

PROG Pin Voltage vs V_{CC} (Constant-Current Mode)

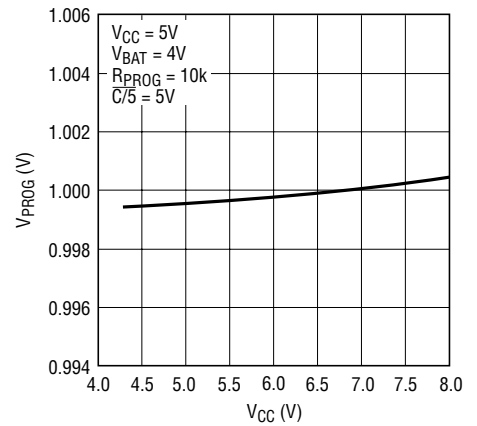

4062 G06

Trickle Charge Current vs Temperature

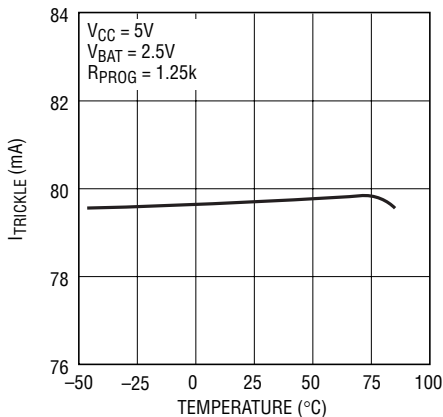

4062 G07

Trickle Charge Threshold Voltage vs Temperature

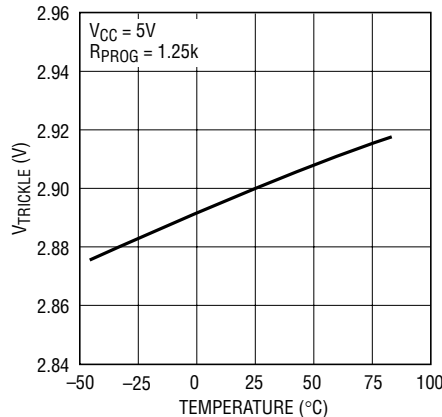

4062 G08

Charge Current vs Battery Voltage

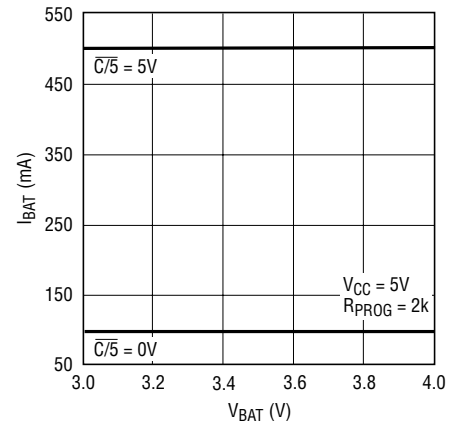

4062 G09

TYPICAL PERFORMANCE CHARACTERISTICS $T_A = 25^\circ\text{C}$ unless otherwise noted.

Internal Charge Timer vs Temperature

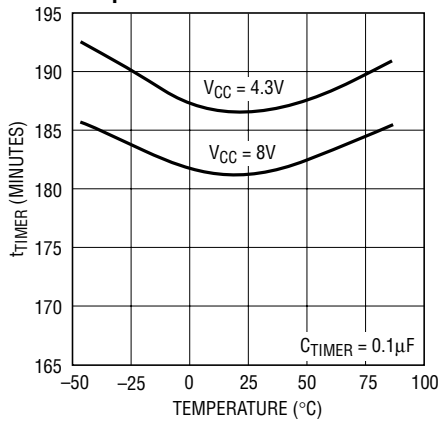

4062 G10

Charge Current vs Ambient Temperature with Thermal Regulation

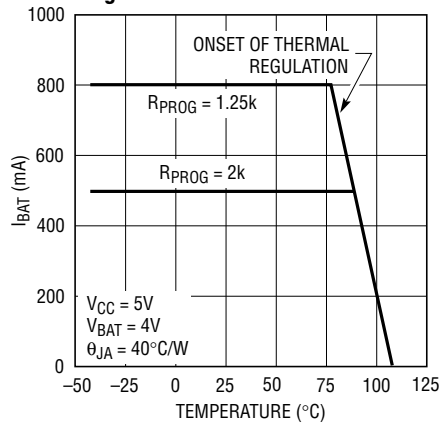

4062 G13

Charge Current vs Supply Voltage

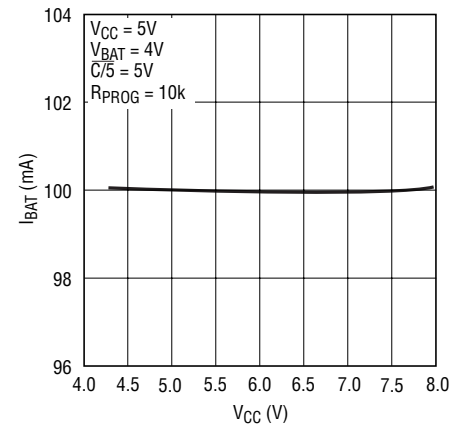

4062 G14

Recharge Threshold Voltage vs Temperature

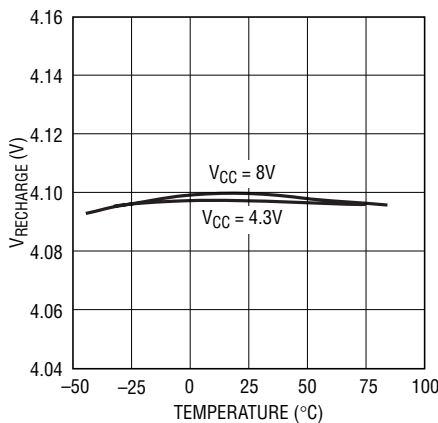

4062 G15

Power FET "ON" Resistance vs Temperature

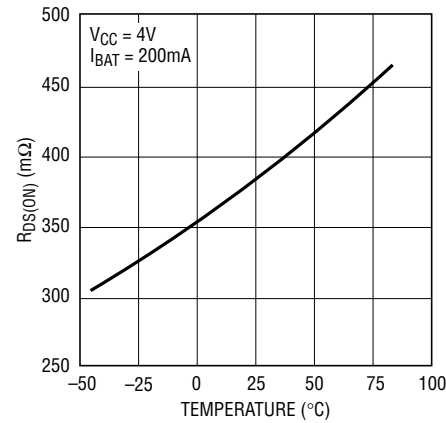

4062 G16

Undervoltage Lockout Voltage vs Temperature

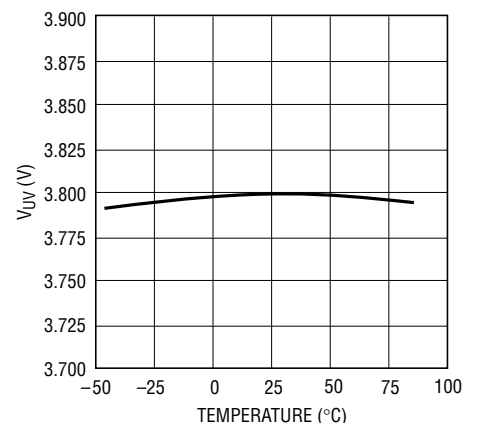

4062 G17

Charge Current vs Battery Voltage

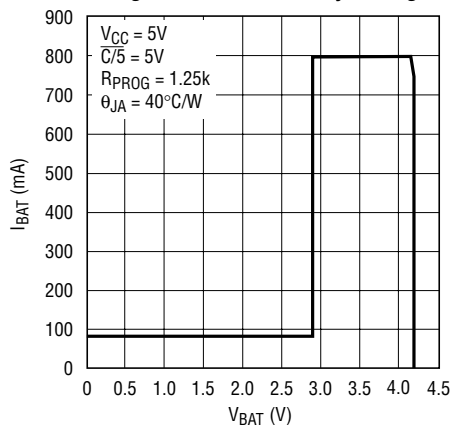

4062 G18

EN Pin Pulldown Resistance vs Temperature

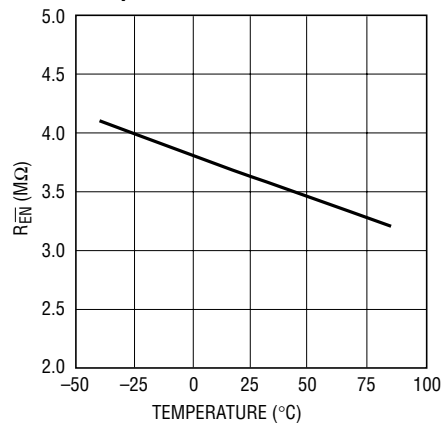

4062 G19

C/5 Pin Pulldown Resistance vs Temperature

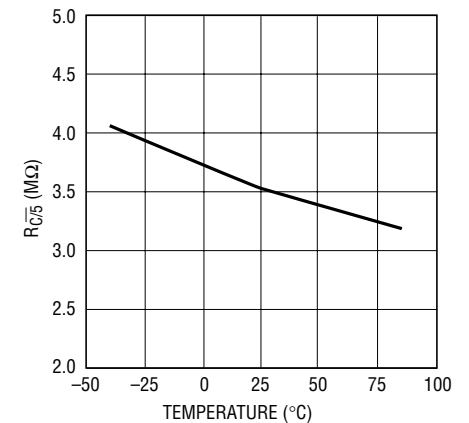

4062 G20

TYPICAL PERFORMANCE CHARACTERISTICS $T_A = 25^\circ\text{C}$ unless otherwise noted.

EN Pin Threshold Voltage (On-to-Off) vs Temperature

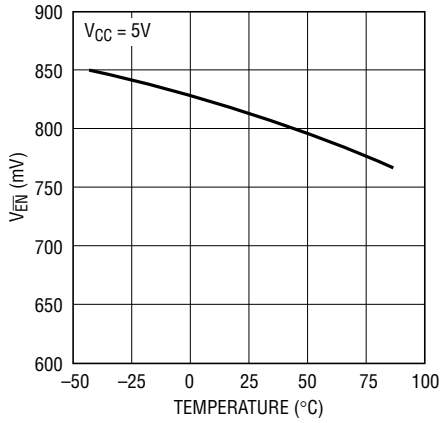

4062 G21

C/5 Pin Threshold Voltage (High-to-Low) vs Temperature

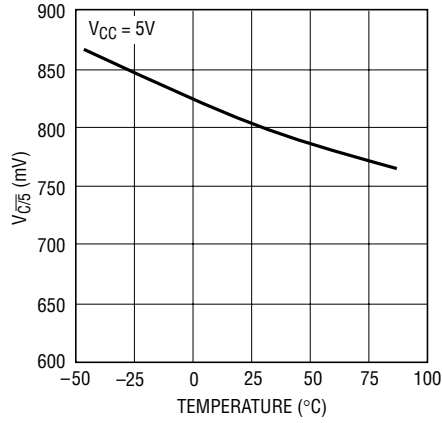

4062 G22

Shutdown Supply Current vs Temperature and V_{CC}

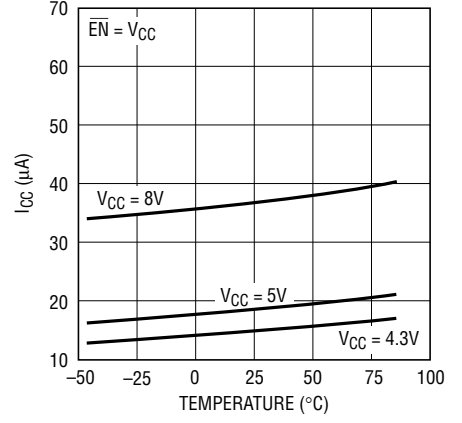

4062 G23

OUT Pin I-V Curve

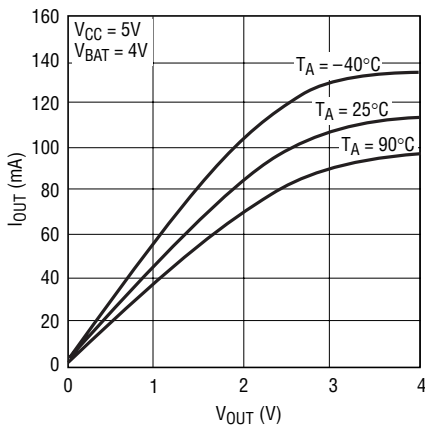

4062 G24

CHRG Pin Output Low Voltage vs Temperature

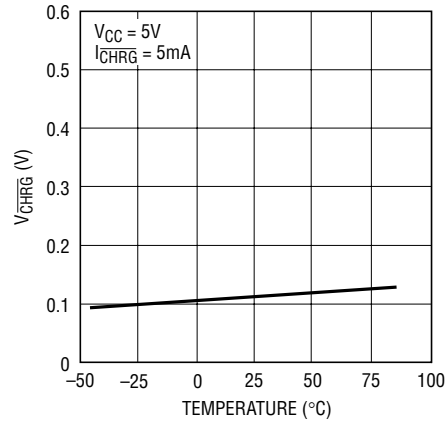

4062 G25

OUT Pin Output Low Voltage vs Temperature

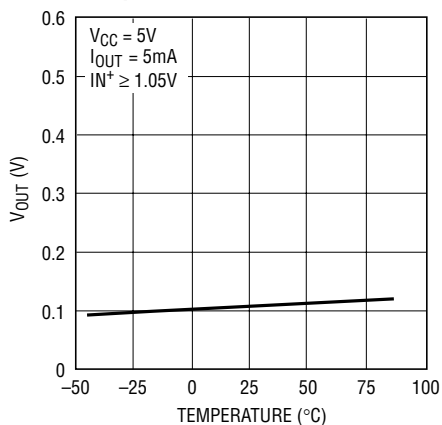

4062 G26

CHRG Pin I-V Curve

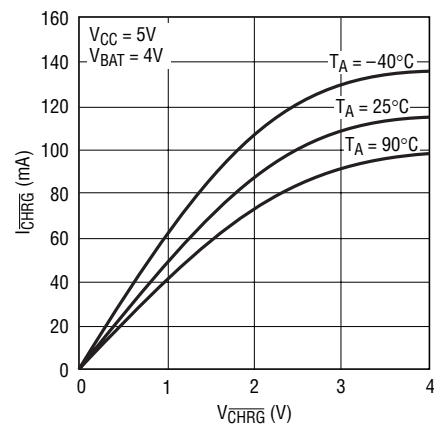

4062 G27

PIN FUNCTIONS

BAT (Pin 1): Charge Current Output. This pin provides charge current to the battery and regulates the final float voltage to 4.2V.

IN⁺ (Pin 2): Positive Input of the Micropower Comparator. The negative input is tied internally to a precise bandgap voltage reference of 1V. There is approximately 50mV of hysteresis associated with the input comparator threshold (rising edge).

TIMER (Pin 3): Timer Program and Termination Select Pin. This pin selects which method is used to terminate the charge cycle. Connecting a capacitor, C_{TIMER}, to ground selects charge time termination. The charge time is set by the following formula:

$$\text{TIME (HOURS)} = 3 \text{ (HOURS)} \cdot \frac{C_{\text{TIMER}}}{0.1\mu\text{F}} \text{ or}$$

$$C_{\text{TIMER}} = 0.1\mu\text{F} \cdot \frac{\text{TIME (HOURS)}}{3 \text{ (HOURS)}}$$

Connecting the TIMER pin to ground selects charge current termination, while connecting the pin to V_{CC} selects user termination. See Applications Information for more information on current and user termination.

OUT (Pin 4): Low Power Comparator Open-Drain Output. This comparator output pin has two states; pull-down and high impedance. This output can be used as a logic interface or as an LED driver. In the pull-down state, an NMOS transistor capable of sinking 10mA pulls down on the OUT pin. The state of this pin is dependent on the value of IN⁺. When IN⁺ is greater than 1V the output pin is in pull-down state, if IN⁺ is less than 1V the output pin is in high impedance state. See Applications Information.

CHRG (Pin 5): Open-Drain Charge Status Output. The charge status indicator pin has three states: pull-down, pulse at 6Hz and high impedance. This output can be used as a logic interface or as a LED driver. In the pull-down state, an NMOS transistor capable of sinking 10mA pulls down on the CHRG pin. The state of this pin depends on the value of I_{DETECT} as well as the termination method being used. See Applications Information.

C/5 (Pin 6): C/5 Enable Input. Used to control the amount of current drawn by the charger when powered from a USB port. A logic high on the C/5 pin sets the current limit to 100% of the current programmed by the PROG pin. A logic low on the C/5 pin sets the current limit to 20% of the current programmed by the PROG pin. An internal 3MΩ pull-down resistor defaults the C/5 pin to its low current state.

EN (Pin 7): Charger Enable Input. A logic high on the EN pin places the charger into shutdown mode, where the input quiescent current is less than 50μA. A logic low on this pin enables charging. An internal 3MΩ pull-down resistor to ground defaults the charger to its enabled state.

IDET (Pin 8): Current Detection Threshold Program Pin. The current detection threshold, I_{DETECT}, is set by connecting a resistor, R_{DETECT}, to ground. I_{DETECT} is set by the following formula:

$$I_{\text{DETECT}} = \frac{R_{\text{PROG}}}{10R_{\text{DET}}} \cdot I_{\text{CHG}} = \frac{100V}{R_{\text{DET}}} \text{ or}$$

$$R_{\text{DET}} = \frac{100V}{I_{\text{DETECT}}}$$

The CHRG pin becomes high impedance when the charge current drops below I_{DETECT}. I_{DETECT} can be set to 1/10th the programmed charge current by connecting I_{DET} directly to PROG. If the I_{DET} pin is not connected, the CHRG output remains in its pull-down state until the charge time elapses and terminates the charge cycle. See Applications Information.

This pin is clamped to approximately 2.4V. Driving this pin to voltages beyond the clamp voltage should be avoided.

PROG (Pin 9): Charge Current Program and Charge Current Monitor. The charge current is set by connecting a resistor, R_{PROG}, to ground. When charging in constant current mode, this pin serves to 1V. The voltage on this pin can be used to measure the charge current using the following formula:

$$I_{\text{BAT}} = \frac{V_{\text{PROG}}}{R_{\text{PROG}}} \cdot 1000$$

LTC4062

PIN FUNCTIONS

V_{CC} (Pin 10): Positive Input Supply Voltage. Provides power to the battery charger. This pin should be bypassed with a 1 μ F capacitor.

GND (Exposed Pad) (Pin 11): Ground. This pin is the back of the exposed metal pad package and must be soldered to the PCB copper for minimal thermal resistance.

BLOCK DIAGRAM

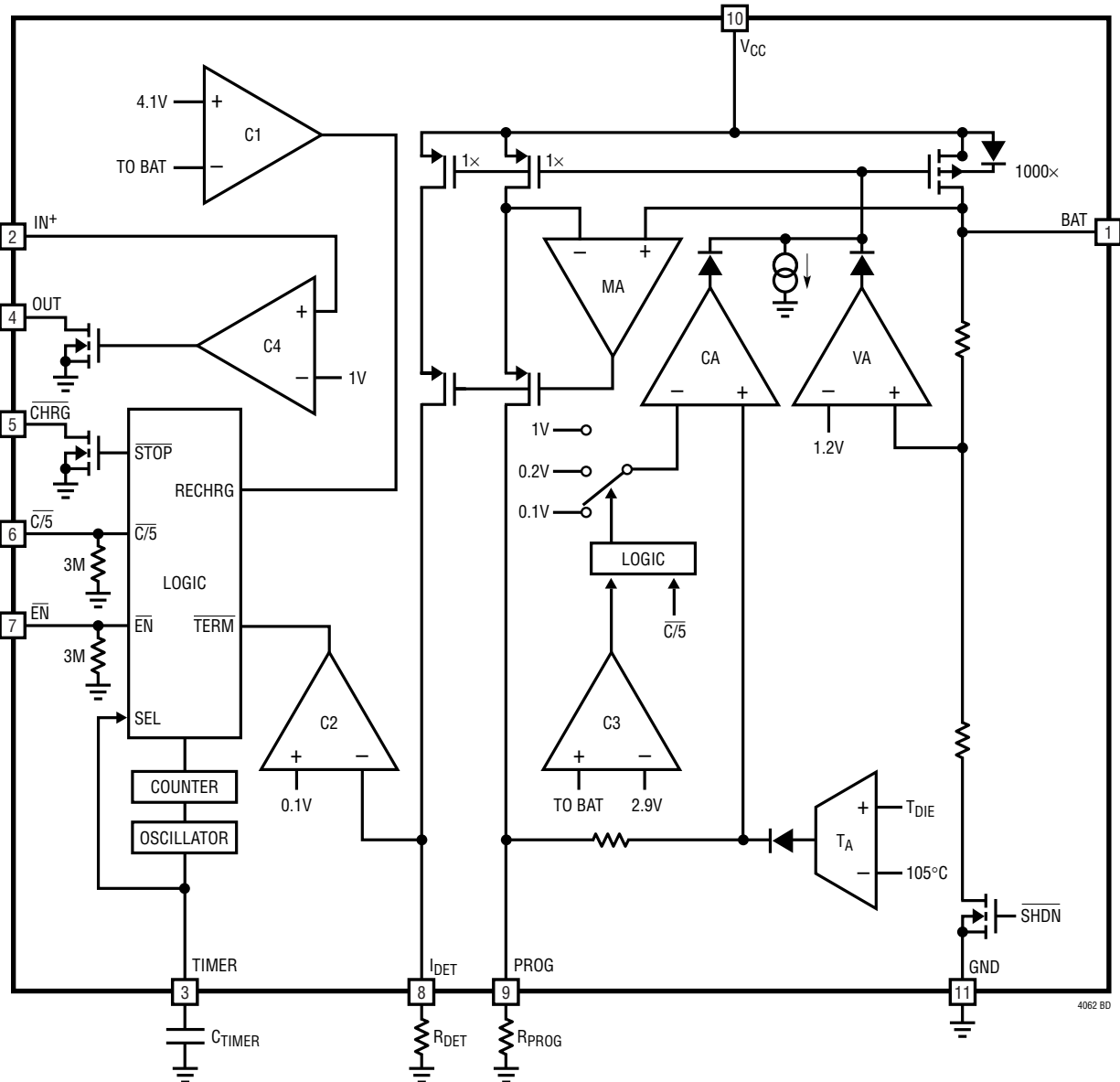

4062 8D

OPERATION

The LTC4062 is designed to charge single-cell lithium-ion batteries. Using the constant current/constant voltage algorithm, the charger can deliver up to 1A of charge current with a final float voltage accuracy of $\pm 0.35\%$. The LTC4062 includes an internal P-channel power MOSFET and thermal regulation circuitry. No blocking diode or external sense resistor is required; thus, the basic charger circuit requires only two external components.

Normal Operation

The charge cycle begins when the voltage at the V_{CC} pin rises above the UVLO level and a discharged battery is connected to BAT. If the BAT pin voltage is below 2.9V, the charger enters trickle charge mode. In this mode, the LTC4062 supplies 1/10th of the programmed charge current in order to bring the battery voltage up to a safe level for full current charging.

Once the BAT pin voltage rises above 2.9V, the charger enters constant current mode, where the programmed charge current is supplied to the battery. When the BAT pin approaches the final float voltage (4.2V), the LTC4062 enters constant voltage mode and the charge current decreases as the battery becomes fully charged.

The LTC4062 offers several methods with which to terminate a charge cycle. Connecting an external capacitor to the TIMER pin activates an internal timer that stops the charge cycle after the programmed time period has elapsed. Grounding the TIMER pin and connecting a resistor to the I_{DET} pin causes the charge cycle to terminate once the charge current falls below a set threshold when the charger is in constant voltage mode. Connecting the TIMER pin to V_{CC} disables internal termination, allowing external charge user termination through the \overline{EN} input. See Applications Information for more information on charge termination methods.

Programming Charge Current

The charge current is programmed using a single resistor from the PROG pin to ground. When the charger is in the constant current mode, the voltage on the PROG pin is 1V. The battery charge current is 1000 times the current out of the PROG pin. The program resistor and the charge current are calculated by the following equations:

$$R_{PROG} = \frac{1000V}{I_{CHG}}, \quad I_{CHG} = \frac{1000V}{R_{PROG}}$$

The charge current out of the BAT pin can be determined at any time by monitoring the PROG pin voltage and applying the following equation:

$$I_{BAT} = \frac{V_{PROG}}{R_{PROG}} \bullet 1000$$

SmartStart

When the LTC4062 is initially powered on or brought out of shutdown mode, the charger checks the battery voltage. If the BAT pin is below the recharge threshold of 4.1V (which corresponds to approximately 80-90% battery capacity), the LTC4062 enters charge mode and begins a full charge cycle. If the BAT pin is above 4.1V, the LTC4062 enters standby mode and does not begin charging. This feature reduces the number of unnecessary charge cycles, prolonging battery life.

Automatic Recharge

When the charger is in standby mode, the LTC4062 continuously monitors the voltage on the BAT pin. When the BAT pin voltage drops below 4.1V, the charge cycle is automatically restarted and the internal timer is reset to 50% of the programmed charge time (if time termination

OPERATION

is being used). This feature eliminates the need for periodic charge cycle initiations and ensures that the battery is always fully charged. Automatic recharge is disabled in user termination mode.

Thermal Regulation

An internal thermal feedback loop reduces the programmed charge current if the die temperature attempts to rise above a preset value of approximately 105°C. This feature protects the LTC4062 from excessive temperature and allows the user to push the limits of the power handling capability of a given circuit board without risk of damaging the LTC4062. The charge current can be set according to typical (not worst-case) ambient temperatures with the assurance that the charger will automatically reduce the current in worst-case conditions.

Undervoltage Lockout (UVLO)

An internal undervoltage lockout circuit monitors the input voltage and keeps the charger in shutdown mode until V_{CC} rises above the undervoltage lockout threshold (3.8V). The UVLO circuit has a built-in hysteresis of 200mV. Furthermore, to protect against reverse current in the power MOSFET, the UVLO circuit keeps the charger in shutdown mode if V_{CC} falls to less than 45mV above the battery voltage. Hysteresis of 145mV prevents the charger from cycling in and out of shutdown.

Manual Shutdown

At any point in the charge cycle, the charger can be put into shutdown mode by pulling the \overline{EN} pin high. This reduces the supply current to less than 50 μ A and the battery drain current of the charger to less than 2 μ A. A new charge cycle can be initiated by floating the \overline{EN} pin or pulling it low.

If shutdown is not required, leaving the pin disconnected continuously enables the circuit.

Trickle-Charge and Defective Battery Detection

When the BAT pin voltage is below the 2.9V trickle charge threshold (V_{TRIKL}), the charger reduces the charge current to 10% of the programmed value. If the battery remains in trickle charge for more than 25% of the total programmed charge time, the charger stops charging and enters a FAULT state, indicating that the battery is defective¹. The LTC4062 indicates the FAULT state by driving the \overline{CHRG} open-drain output with a square wave. The duty cycle of this oscillation is 50% and the frequency is set by C_{TIMER} :

$$f_{\overline{CHRG}} = \frac{0.1\mu F}{C_{TIMER}} \bullet 6\text{Hz}$$

A LED driven by the \overline{CHRG} output exhibits a pulsing pattern, indicating to the user that the battery needs replacing. To exit the FAULT state, the charger must be restarted either by toggling the \overline{EN} input or removing and reapplying power to V_{CC} .

Charge Status Output (\overline{CHRG})

The charge status indicator pin has three states: pull-down, pulse at 6Hz and high impedance. In the pull-down state, an NMOS transistor pulls down on the \overline{CHRG} pin capable of sinking up to 10mA. A pull-down state indicates that the LTC4062 is charging a battery and the charge current is greater than I_{DETECT} (which is set by the external component R_{DET}). A high impedance state indicates that the charge current has dropped below I_{DETECT} . In the case where the I_{DET} pin is left unconnected ($R_{DET} = \infty$, $I_{DETECT} = 0$), a high impedance state on \overline{CHRG} indicates that the LTC4062 is not charging.

¹The Defective Battery Detection Feature is only available when time termination is being used.

OPERATION

Smart Pulsing Error Feature

LTC4062 has a pulsing state at the $\overline{\text{CHRG}}$ pull-down pin of 6Hz (50% duty cycle) due to defective battery detection (see Trickle-Charge and Defective Battery Detection section).

Low Power Comparator (IN⁺; OUT)

The low power, low offset comparator is designed with an internal 1V reference connected to the negative input. This reference is generated by a precise bandgap circuit. The

comparator output drives a pull down NMOS transistor able to sink up to 10mA. Voltages lower than 1V at the IN⁺ pin set the OUT pin to a high impedance state.

Voltages higher than 1V plus a built-in 50mV hysteresis at the IN⁺ pin set the OUT pin to a low impedance state. The comparator is operational even when V_{CC} is not applied provided the BAT pin voltage is greater than 2.5V. When the voltage at the BAT pin drops below 2.5V, the comparator shuts down and the current at the BAT pin is reduced to $<1\mu\text{A}$.

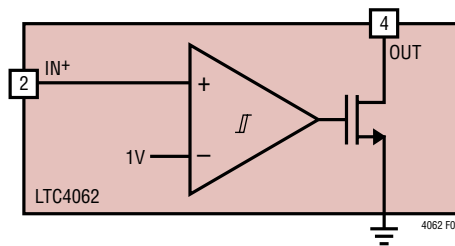

Figure 1. Low Power Comparator Circuit

APPLICATIONS INFORMATION

Programming Charge Termination

The LTC4062 can terminate a charge cycle using one of several methods, allowing the designer considerable flexibility in choosing an ideal charge termination algorithm. Table 1 shows a brief description of the different termination methods and their behaviors.

Charge Time Termination

Connecting a capacitor (C_{TIMER}) to the TIMER pin enables the timer and selects charge time termination. The total charge time is set by:

$$\text{TIME (HOURS)} = \frac{C_{\text{TIMER}}}{0.1\mu\text{F}} \cdot 3 \text{ HOURS}$$

When the programmed time has elapsed, the charge cycle terminates and the charger enters standby mode. Subsequent recharge cycles terminate when 50% of the programmed time has elapsed. The I_{DET} pin determines the behavior of the $\overline{\text{CHRG}}$ output. Connecting a resistor (R_{DET}) from the I_{DET} pin to ground sets the charge current detection threshold, I_{DETECT} :

$$I_{\text{DETECT}} = \frac{R_{\text{PROG}}}{10R_{\text{DET}}} \cdot I_{\text{CHG}} = \frac{100\text{V}}{R_{\text{DET}}} \text{ or}$$

$$R_{\text{DET}} = \frac{100\text{V}}{I_{\text{DETECT}}}$$

When the charge current (I_{BAT}) is greater than I_{DETECT} , the $\overline{\text{CHRG}}$ output is in its pull-down state. When the charger enters constant voltage mode operation and the charge current falls below I_{DETECT} , the $\overline{\text{CHRG}}$ output becomes high impedance, indicating that the battery is almost fully charged. The $\overline{\text{CHRG}}$ output will also become high impedance once the charge time elapses. If the I_{DET} pin is not connected, the $\overline{\text{CHRG}}$ output remains in its pull-down state until the charge time elapses and terminates the charge cycle.

Figure 2 shows a charger circuit using charge time termination that is programmed to charge at 500mA. Once the charge current drops below 100mA in constant voltage mode (as set by R_{DET}), the $\overline{\text{CHRG}}$ output turns off the LED. This indicates to the user that the battery is almost fully charged and ready to use. The LTC4062 continues to

Table 1

METHOD	TIMER	I_{DET}	CHARGER DESCRIPTION	$\overline{\text{CHRG}}$ OUTPUT DESCRIPTION
Charge Time Termination Mode	0.1 μF to GND	R_{DET} to GND	Charges for 3 Hours. After 3 Hours, the Charger Stops Charging and Enters Standby Mode. Recharge Cycles Last for 1.5 Hours.	Pull-Down State While $I_{\text{BAT}} > I_{\text{DET}}$. High Impedance State While $I_{\text{BAT}} < I_{\text{DETECT}}$ or When Charging Is Stopped. Pulsing State Available When NTC Is Used and Is Still Charging.
	0.1 μF to GND	NC	Charges for 3 Hours. After 3 Hours, the Charger Stops Charging and Enters Standby Mode. Recharge Cycles Last for 1.5 Hours.	Pull-Down State When Charging. High Impedance State When Charging Is Stopped. Pulsing State Available When NTC Is Used and Is Still Charging.
Charge Current Termination	GND	R_{DET} to GND	Charges Until Charge Current Drops Below I_{DET} , Then Enters Standby Mode.	Pull-Down State When Charging. High Impedance State When Charging Is Stopped. Pulsing State Available When NTC Is Used and Is Still Charging.
	GND	NC	Charges Indefinitely.	Pull-Down State When Charging. High Impedance State When Charging Is Stopped. Pulsing State Available When NTC Is Used and Is Still Charging.
User Selectable Charge Termination	VCC	R_{DET} to GND	Charges Indefinitely. SmartStart Is Disabled.	Pull-Down State While $I_{\text{BAT}} > I_{\text{DETECT}}$. High Impedance State While $I_{\text{BAT}} < I_{\text{DETECT}}$ or When Charging Is Stopped. Pulsing State Available When NTC Is Used and Is Still Charging.
	VCC	NC	Charges Indefinitely. SmartStart Is Disabled.	Pull-Down State When Charging. High Impedance State When Charging Is Stopped. Pulsing State Available When NTC Is Used and Is Still Charging.

APPLICATIONS INFORMATION

charge the battery until the internal timer reaches 3 hours (as set by C_{TIMER}). During recharge cycles, the LTC4062 charges the battery until the internal timer reaches 1.5 hours. Figure 3 describes the operation of the LTC4062 charger when charge time termination is used.

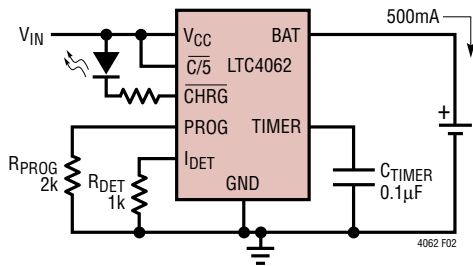

Figure 2. Time Termination Mode.
The Charge Cycle Ends After 3 Hours

Charge Current Termination

Connecting the TIMER pin to ground selects charge current termination. With this method, the timer is disabled and a resistor (R_{DET}) must be connected from the I_{DET} pin to ground. I_{DETECT} is programmed using the same equation stated in the previous section. The charge cycle terminates when the charge current falls below I_{DETECT} . This condition is detected using an internal filtered comparator to monitor the I_{DET} pin. When the I_{DET} pin falls below 100mV for longer than t_{TERM} (typically 1.5ms), charging is terminated.

When charging, transient loads on the BAT pin can cause the I_{DET} pin to fall below 100mV for short periods of time before the DC current has dropped below the I_{DETECT}

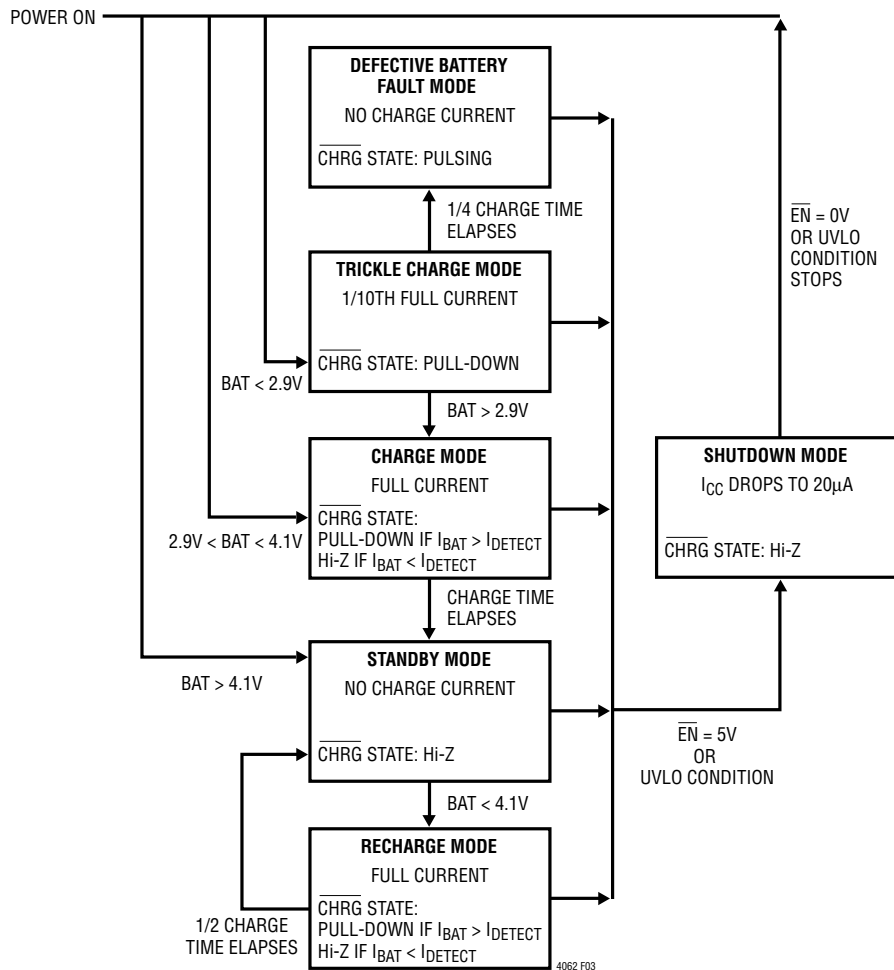

Figure 3. State Diagram of a Charge Cycle
Using Charge Time Termination

APPLICATIONS INFORMATION

threshold. The 1.5ms filter time (t_{TERM}) on the internal comparator ensures that transient loads of this nature do not result in premature charge cycle termination. Once the *average* charge current drops below I_{DETECT} , the charger terminates the charge cycle.

The \overline{CHRG} output is in a pull-down state while charging and in a high impedance state once charging has stopped. Figure 4 describes the operation of the LTC4062 charger when charge current termination is used.

When the charger is set for charge current termination and the battery is removed from the charger, a sawtooth waveform of several hundred mV will appear at the charger output. This is caused by the repeated cycling between termination and recharge events. This cycling results in pulsing at the \overline{CHRG} output. If an LED is connected to this pin, it will exhibit a pulsing pattern, indicating to the user that a battery is not present. The frequency of the sawtooth is dependent on the amount of output capacitance.

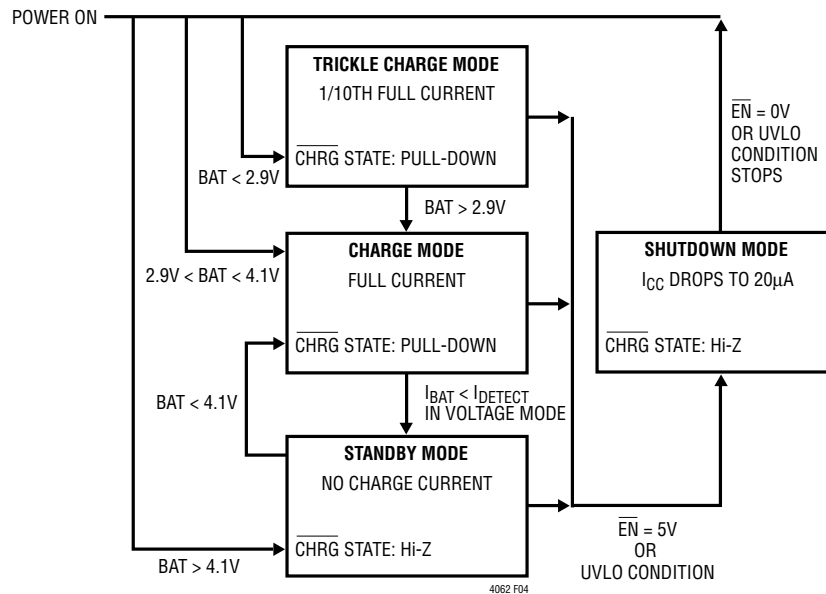

Figure 4. State Diagram of a Charge Cycle Using Charge Current Termination

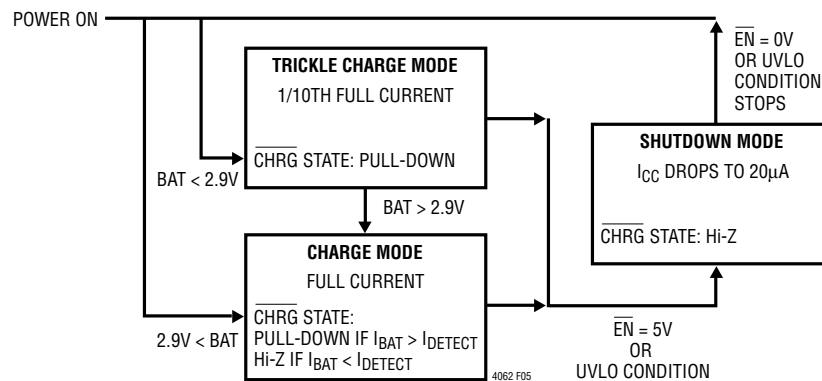

Figure 5. State Diagram of a Charge Cycle Using User-Selectable Termination

APPLICATIONS INFORMATION

User-Selectable Charge Termination

Connecting the TIMER pin to V_{CC} selects user-selectable charge termination, in which all of the internal termination features are disabled. The charge cycle continues indefinitely until the charger is shut down through the EN pin. The I_{DET} pin programs the behavior of the CHRG output in the same manner as when using charge time termination. If the I_{DET} pin is not connected, the CHRG output remains in its pull-down state until the charger is shut down.

With user-selectable charge termination, the SmartStart feature is disabled; when the charger is powered on or enabled, the LTC4062 automatically begins charging, regardless of the battery voltage. Figure 5 describes charger operation when user-selectable charge termination is used.

Programming C/10 Current Detection/Termination

In most cases, an external resistor, R_{DET} , is needed to set the charge current detection threshold, I_{DETECT} . However, when setting I_{DETECT} to be 1/10th of I_{CHG} , the I_{DET} pin can be connected directly to the PROG pin. This reduces the component count, as shown in Figure 6.

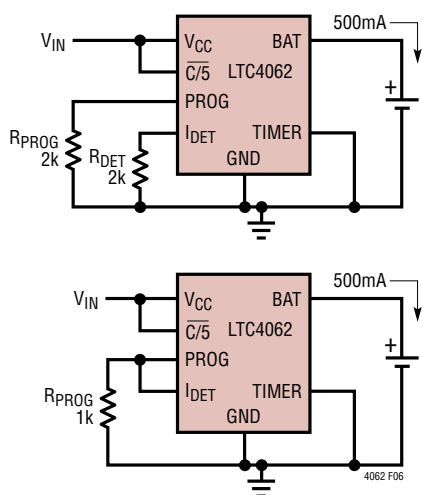

Figure 6. Two Circuits That Charge at 500mA Full-Scale Current and Terminate at 50mA

When PROG and I_{DET} are connected in this way, the full-scale charge current, I_{CHG} , is programmed with a different equation:

$$R_{PROG} = \frac{500V}{I_{CHG}}, I_{CHG} = \frac{500V}{R_{PROG}}$$

Stability Considerations

The battery charger constant voltage mode feedback loop is stable without any compensation provided a battery is connected. However, a $1\mu F$ capacitor with a 1Ω series resistor to GND is recommended at the BAT pin to reduce noise when no battery is present.

When the charger is in constant current mode, the PROG pin is in the feedback loop, not the battery. The constant current stability is affected by the impedance at the PROG pin. With no additional capacitance on the PROG pin, the charger is stable with program resistor values as high as $10k\Omega$; however, additional capacitance on this node reduces the maximum allowed program resistor value.

Power Dissipation

When designing the battery charger circuit, it is not necessary to design for worst-case power dissipation scenarios because the LTC4062 automatically reduces the charge current during high power conditions. The conditions that cause the LTC4062 to reduce charge current through thermal feedback can be approximated by considering the power dissipated in the IC. Most of the power dissipation is generated from the internal charger MOSFET. Thus, the power dissipation is calculated to be approximately:

$$P_D = (V_{CC} - V_{BAT}) \cdot I_{BAT}$$

P_D is the power dissipated, V_{CC} is the input supply voltage, V_{BAT} is the battery voltage and I_{BAT} is the charge current. The approximate ambient temperature at which the thermal feedback begins to protect the IC is:

$$T_A = 105^\circ C - P_D \cdot \theta_{JA}$$

$$T_A = 105^\circ C - (V_{CC} - V_{BAT}) \cdot I_{BAT} \cdot \theta_{JA}$$

APPLICATIONS INFORMATION

Example: An LTC4062 operating from a 5V wall adapter is programmed to supply 800mA full-scale current to a discharged Li-Ion battery with a voltage of 3.3V. Assuming θ_{JA} is 40°C/W (see Thermal Considerations), the ambient temperature at which the LTC4062 will begin to reduce the charge current is approximately:

$$T_A = 105^\circ\text{C} - (5\text{V} - 3.3\text{V}) \cdot (800\text{mA}) \cdot 40^\circ\text{C}/\text{W}$$

$$T_A = 105^\circ\text{C} - 1.36\text{W} \cdot 40^\circ\text{C}/\text{W} = 105^\circ\text{C} - 54.4^\circ\text{C}$$

$$T_A = 50.6^\circ\text{C}$$

The LTC4062 can be used above 50.6°C ambient, but the charge current will be reduced from 800mA. The approximate current at a given ambient temperature can be approximated by:

$$I_{\text{BAT}} = \frac{105^\circ\text{C} - T_A}{(V_{\text{CC}} - V_{\text{BAT}}) \cdot \theta_{JA}}$$

Using the previous example with an ambient temperature of 60°C, the charge current will be reduced to approximately:

$$I_{\text{BAT}} = \frac{105^\circ\text{C} - 60^\circ\text{C}}{(5\text{V} - 3.3\text{V}) \cdot 40^\circ\text{C}/\text{W}} = \frac{45^\circ\text{C}}{68^\circ\text{C}/\text{A}}$$

$$I_{\text{BAT}} = 662\text{mA}$$

It is important to remember that LTC4062 applications do not need to be designed for worst-case thermal conditions, since the IC will automatically reduce power dissipation if the junction temperature reaches approximately 105°C.

Thermal Considerations

In order to deliver maximum charge current under all conditions, it is critical that the exposed metal pad on the backside of the LTC4062 package is properly soldered to the PC board ground. Correctly soldered to a 2500mm² double sided 1oz copper board, the LTC4062 has a thermal resistance of approximately 40°C/W. Failure to make thermal contact between the exposed pad on the backside of the package and the copper board will result in thermal resistances far greater than 40°C/W. As an example, a

correctly soldered LTC4062 can deliver over 800mA to a battery from a 5V supply at room temperature. Without a good backside thermal connection, this number could drop to less than 500mA.

V_{CC} Bypass Capacitor

Many types of capacitors can be used for input bypassing; however, caution must be exercised when using multi-layer ceramic capacitors. Because of the self-resonant and high Q characteristics of some types of ceramic capacitors, high voltage transients can be generated under some start-up conditions such as connecting the charger input to a live power source. Adding a 1.5Ω resistor in series with an X5R ceramic capacitor will minimize start-up voltage transients. For more information, see Application Note 88.

Charge Current Soft-Start and Soft-Stop

The LTC4062 includes a soft-start circuit to minimize the inrush current at the start of a charge cycle. When a charge cycle is initiated, the charge current ramps from zero to the full-scale current over a period of approximately 100μs. Likewise, internal circuitry slowly ramps the charge current from full-scale to zero when the charger is shut off or self terminates. This has the effect of minimizing the transient current load on the power supply during start-up and charge termination.

Reverse Polarity Input Voltage Protection

In some applications, protection from reverse polarity on V_{CC} is desired. If the supply voltage is high enough, a series blocking diode can be used. In other cases, where the diode voltage drop must be kept low, a P-channel MOSFET can be used (as shown in Figure 7).

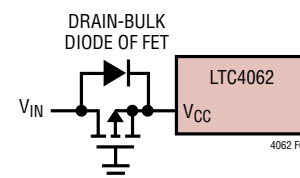

Figure 7. Low Loss Input Reverse Polarity Protection

APPLICATIONS INFORMATION

USB and Wall Adapter Power

The LTC4062 allows charging from both a wall adapter and a USB port. Figure 8 shows an example of how to combine wall adapter and USB power inputs. A P-channel MOSFET, MP1, is used to prevent back conducting into the USB port when a wall adapter is present and a Schottky diode, D1, is used to prevent USB power loss through the 1k Ω pull-down resistor.

Typically a wall adapter can supply more current than the 500mA limited USB port. Therefore, an N-channel MOSFET, MN1, and an extra 3.3k Ω program resistor are used to increase the charge current to 800mA when the wall adapter is present.

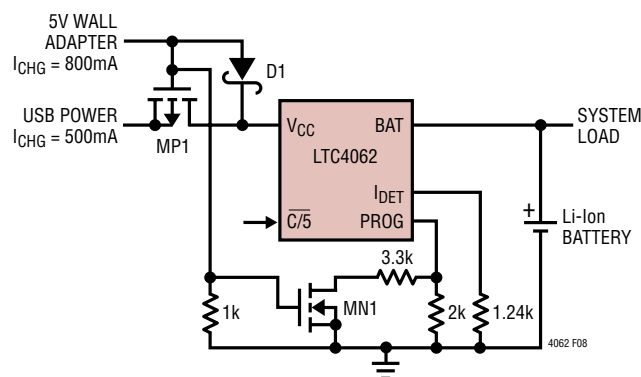

Figure 8. Combining Wall Adapter and USB Power

