

## FEATURES

- Complete Low Power Wireless NiMH Charger
- Low Minimum Input Voltage: 2.2V
- Small Total Solution Volume
- 1.5V, 25mA Linear Single-Cell NiMH Charger
- Temperature Compensated Charge Voltage
- Integrated Rectifier with Overvoltage Limit
- Zinc-Air Battery Detection
- Reverse Polarity Protection
- Thermally Enhanced 6-Lead (2mm × 2mm) DFN package

## APPLICATIONS

- Hearing Aids
- Smart Cards
- Fitness Devices
- Moving and/or Rotating Equipment

## DESCRIPTION

The **LTC<sup>®</sup>4123** is a low power wireless receiver and a constant-current/constant-voltage linear charger for NiMH batteries. An external programming resistor sets the charge current up to 25mA. The temperature compensated charge voltage feature protects the NiMH battery and prevents overcharging.

Wireless charging with the LTC4123 allows products to be charged while sealed within enclosures and eliminates bulky connectors in space constrained environments. The LTC4123 also makes it possible to charge NiMH batteries used in moving or rotating equipment.

The LTC4123 prevents charging of Zinc-Air batteries as well as batteries inserted with reverse polarity. The LTC4123 pauses charging if its temperature is too hot or too cold. An internal timer provides time-based charging termination.

The 2mm × 2mm DFN package and low external component count make the LTC4123 well-suited for hearing aid applications or other low power portable devices where small solution size is mandatory.

LT, LT, LTC, LTM, Linear Technology and the Linear logo are registered trademarks of Linear Technology Corporation. All other trademarks are the property of their respective owners.

## TYPICAL APPLICATION

25mA NiMH Wireless Battery Charger

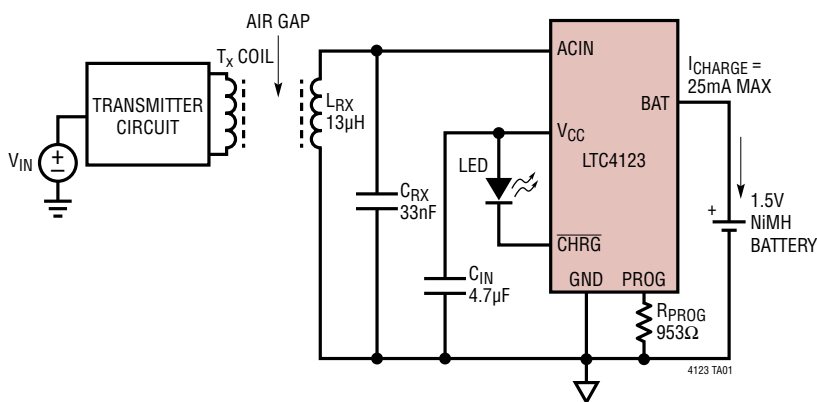

Complete Wireless Charging Solution for a Hearing Aid

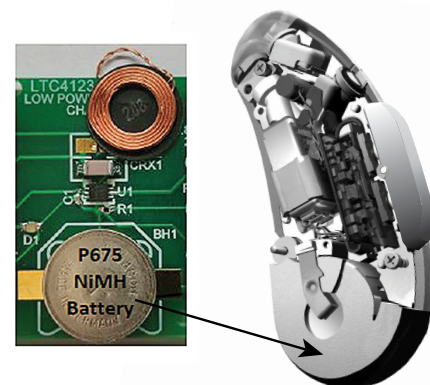

# LTC4123

## ABSOLUTE MAXIMUM RATINGS

(Notes 1, 3)

Input Supply Voltages

$V_{CC}$ ..... -0.3V to 5.5V

ACIN ..... -10V to  $V_{CC}+1V$

Input Supply Currents

$I(ACIN)$ ..... 200mA

BAT ..... -2V to 2V

PROG, CHRG..... -0.3V to  $V_{CC}+0.3V$

Operating Junction Temperature Range

(Note 2)..... -20 to 85°C

Storage Temperature Range ..... -65 to 150°C

## PIN CONFIGURATION

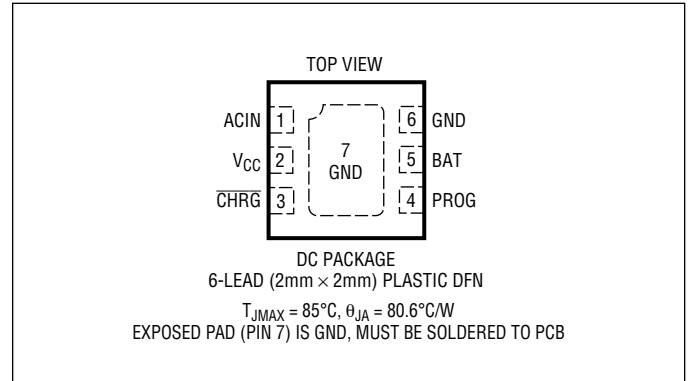

## ORDER INFORMATION <http://www.linear.com/product/LTC4123#orderinfo>

LEAD FREE FINISH	TAPE AND REEL	PART MARKING*	PACKAGE DESCRIPTION	TEMPERATURE RANGE
LTC4123EDC#PBF	LTC4123EDC#TRPBF	LGSY	6-Lead (2mm x 2mm) Plastic DFN	-20°C to 85°C

Consult LTC Marketing for parts specified with wider operating temperature ranges.

For more information on lead free part marking, go to: <http://www.linear.com/leadfree/>

For more information on tape and reel specifications, go to: <http://www.linear.com/tapeandreel/>. Some packages are available in 500 unit reels through designated sales channels with #TRMPBF suffix.

## ELECTRICAL CHARACTERISTICS

The ● denotes the specifications which apply over the specified operating junction temperature range, otherwise specifications are at  $T_A = 25^\circ\text{C}$ .  $V_{ACIN} = 0V$ ,  $V_{CC} = 5V$  unless otherwise noted (Notes 2, 3, 4).

SYMBOL	PARAMETER	CONDITIONS	MIN	TYP	MAX	UNITS
$V_{CC}$	Input Supply Operating Range		● 2.2		5	V
$I_{VCC}$	Input Quiescent Operating Current	Charging Terminated. $I_{BAT}$ and $I_{PROG} = 0A$	●	125	200	$\mu A$
$V_{UVLO}$	Input Supply Undervoltage Lockout Threshold	$V_{CC}$ Rising	1.88	1.95	2.02	V
	Hysteresis			40		mV
$V_{BAT}$	Battery Charge Voltage	$T_A = 25^\circ\text{C}$	1.4955	1.5075	1.5195	V
		$T_A = -10^\circ\text{C}$ (Note 4)	1.580	1.595	1.610	V
		$T_A = 75^\circ\text{C}$ (Note 4)	1.3675	1.3825	1.3975	V
$I_{BAT(LEAK)}$	Battery Pin Discharge Current	Charger Terminated or $V_{CC} < V_{UVLO}$ , $V_{BAT} = 2V$			100	nA
$V_{PROG}$	PROG Pin Servo Voltage			0.25		V
$h_{PROG}$	Ratio of BAT Current to PROG Current			96		mA/mA
$I_{CHG}$	Constant-Current Mode Charge Current	$R_{PROG} = 23.7k\Omega$	● 0.73	1	1.27	mA
		$R_{PROG} = 953\Omega$	● 22	25	28	mA
$V_{UVCL}$	Undervoltage Current Limit	$R_{PROG} = 4.99k\Omega$		2.2		V
$T_{CHG}$	Charge Termination Period		4.8	6	7.2	Hours

4123fa

## ELECTRICAL CHARACTERISTICS

The ● denotes the specifications which apply over the specified operating junction temperature range, otherwise specifications are at  $T_A = 25^\circ\text{C}$ .  $V_{ACIN} = 0\text{V}$ ,  $V_{CC} = 5\text{V}$  unless otherwise noted (Notes 2, 3, 4).

SYMBOL	PARAMETER	CONDITIONS	MIN	TYP	MAX	UNITS
<b>Thermal Sensing</b>						
	Cold Temperature Fault Threshold	Die Temperature Falling		-5		$^\circ\text{C}$
	Hysteresis			5		$^\circ\text{C}$
	Hot Temperature Fault Threshold	Die Temperature Rising		70		$^\circ\text{C}$
	Hysteresis			5		$^\circ\text{C}$
<b>Zinc-Air Battery Detection</b>						
$V_{Zn-AIR}$	Zinc-Air Fault Threshold Voltage	$V_{BAT}$ Rising	1.60	1.65		V
	Hysteresis			40		mV
$T_{Zn-AIR}$	Zinc-Air Detection Period			80		s
	Charge Voltage Limit	During Zinc-Air Battery Detection			1.8	V
	Zinc-Air Detection Charge Current	$R_{PROG} = 23.7\text{k}\Omega$		1		mA
<b>Reverse Polarity Detection</b>						
$V_{REVPOL}$	Reverse Polarity Threshold Voltage	$V_{BAT}$ Falling		-50		mV
	Hysteresis			40		mV
<b>AC Rectification</b>						
$V_{CC(HIGH)}$	$V_{CC}$ High Voltage Limit	$V_{CC}$ Rising		5		V
$V_{CC(LOW)}$	$V_{CC}$ Low Voltage Limit	$V_{CC}$ Falling		3		V
	ACIN to $V_{CC}$ Voltage Drop	$I_{VCC} = -20\text{mA}$ , Charger Terminated		0.65		V
<b>Status Pin (CHRG)</b>						
$I_{CHRG}$	CHRG Pin Pull-Down Current	$V_{CHRG} = 450\text{mV}$	250	340	430	$\mu\text{A}$
	CHRG Leakage Current	$\overline{\text{CHRG}} = 5\text{V}$			1	$\mu\text{A}$

**Note 1:** Stresses beyond those listed under Absolute Maximum Ratings may cause permanent damage to the device. Exposure to any Absolute Maximum Rating condition for extended periods may affect device reliability and lifetime.

**Note 2:** The LTC4123 is tested under conditions such that  $T_J \approx T_A$ . The LTC4123E is guaranteed to meet specifications from  $0^\circ\text{C}$  to  $85^\circ\text{C}$  junction temperature. Specifications over the  $-20^\circ\text{C}$  to  $85^\circ\text{C}$  operating junction temperature are assured by design, characterization and correlation with statistical process controls. Note that the maximum ambient temperature consistent with these specifications is determined by specific operating conditions in conjunction with board layout, the rated package thermal

impedance and other environmental factors. The junction temperature ( $T_J$ , in  $^\circ\text{C}$ ) is calculated from the ambient temperature ( $T_A$ , in  $^\circ\text{C}$ ) and power dissipation (PD, in Watts) according to the following formula:

$T_J = T_A + (P_D \cdot \theta_{JA})$ , where  $\theta_{JA}$  (in  $^\circ\text{C}/\text{W}$ ) is the package thermal impedance.

**Note 3:** All currents into pins are positive; all voltages are referenced to GND unless otherwise noted.

**Note 4:** These parameters are guaranteed by design and are not 100% tested. The battery charge voltage variation over temperature is guaranteed in a  $\pm 15\text{mV}$  band as shown in the Typical Performance Characteristics curve.

## TYPICAL PERFORMANCE CHARACTERISTICS $T_A = 25^\circ\text{C}$ , unless otherwise noted.

**Battery Charge Current vs Battery Charge Voltage**

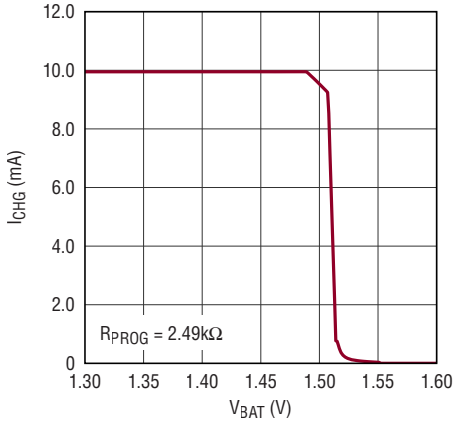

**Battery Charge Voltage vs Temperature**

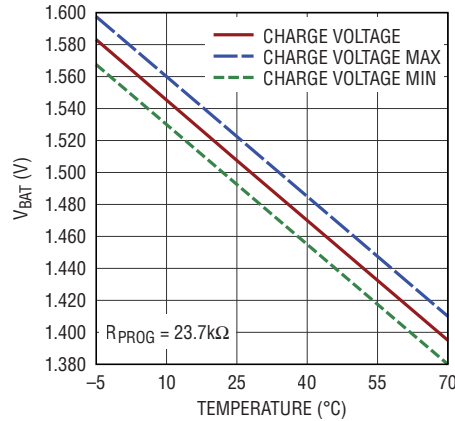

**Battery Charge Voltage vs Supply Voltage**

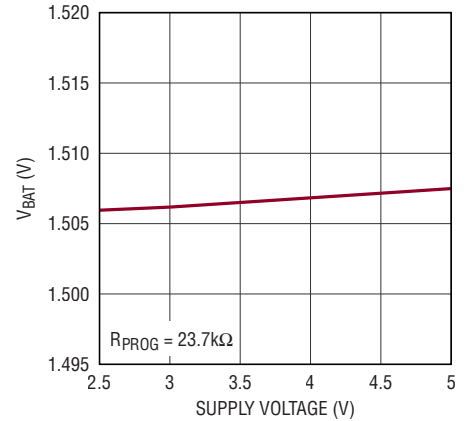

**PROG Pin Voltage vs Temperature (Constant Current Mode)**

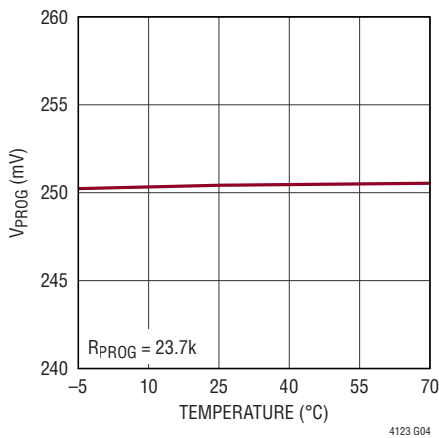

**Undervoltage Current Limit: Charge Current vs Supply Voltage**

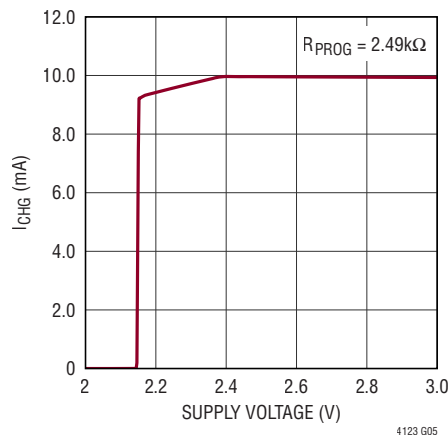

**Charge Current vs PROG Pin Voltage**

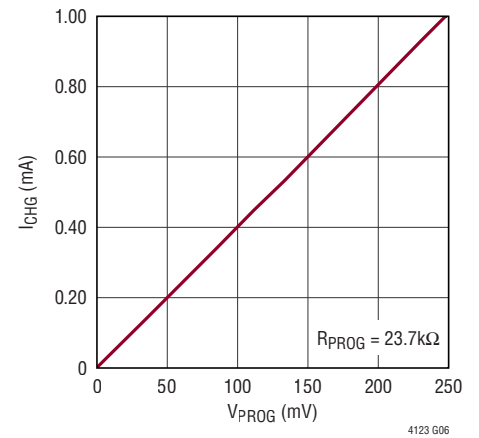

**Input Quiescent Current vs Supply Voltage**

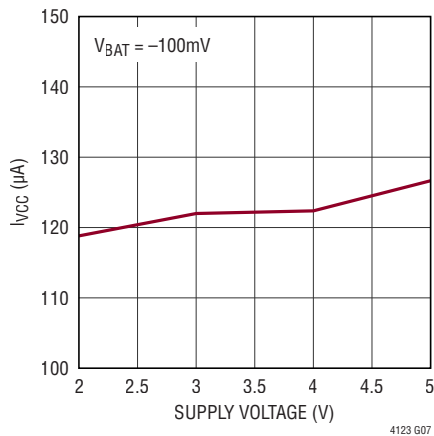

**Battery Leakage Current vs Temperature**

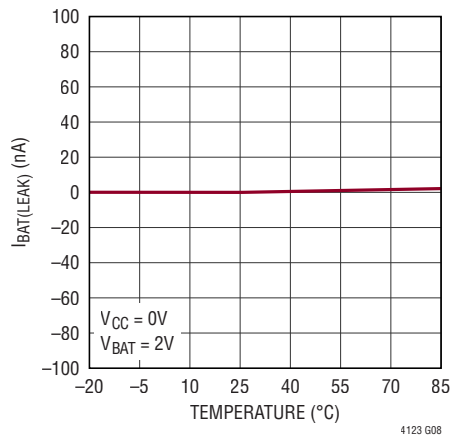

**UVLO Threshold vs Temperature (Rising and Falling)**

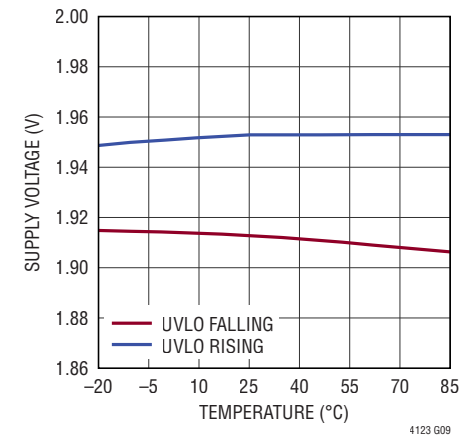

**TYPICAL PERFORMANCE CHARACTERISTICS**  $T_A = 25^\circ\text{C}$ , unless otherwise noted.

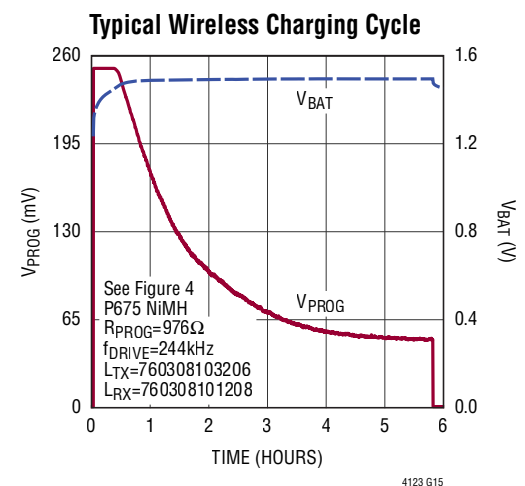
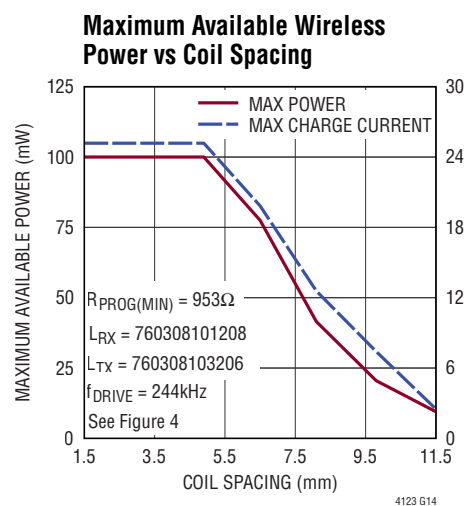
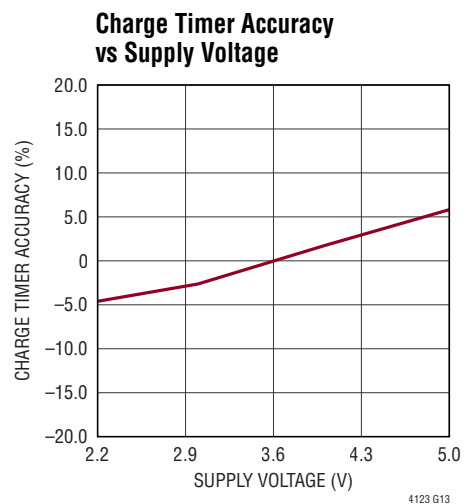
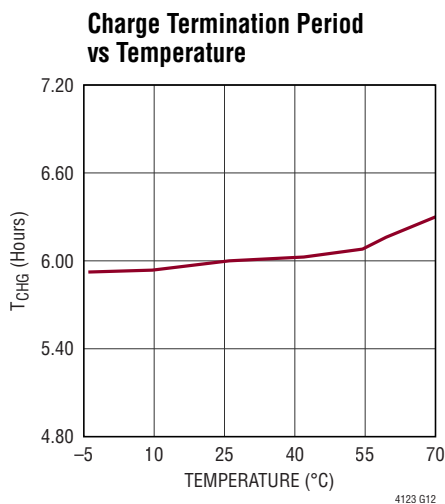
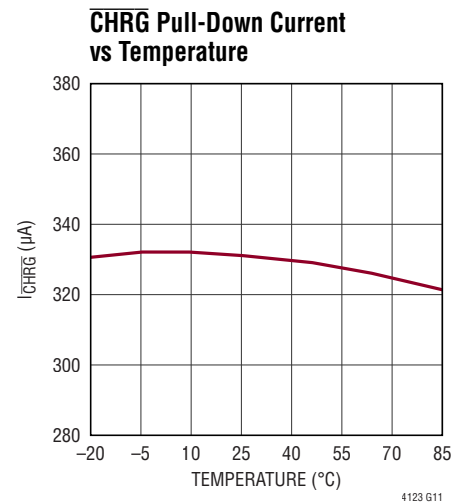
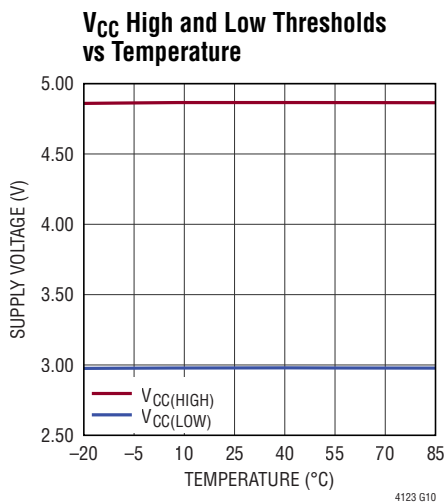

## PIN FUNCTIONS

**ACIN (Pin 1):** AC Input Voltage. Connect the external LC tank, which includes the receive inductor, to this pin. Short this pin to ground when not used.

**V<sub>CC</sub> (Pin 2):** The DC input voltage range is 2.2V to 5V. An internal diode is connected from the ACIN pin (anode) to this pin (cathode). When an AC voltage is present at the ACIN pin, the voltage on this pin is the rectified AC voltage. Connect a 4.7μF capacitor to ground on this pin. When the ACIN pin is not used (shorted to ground), connect this pin to a DC voltage source to provide power to the part and to charge the battery.

**CHRG (Pin 3):** Open-Drain charge status output.  $\overline{\text{CHRG}}$  requires a pull-up resistor and/or LED to indicate the status of the battery charger. This pin has four possible states: powered on/charging (blink slow), no power/not charging (high impedance), charging complete (pull-down), and Zinc-Air battery/reverse polarity detection/ battery temperature out of range/UVCL at the beginning of the charge cycle (blink fast). To conserve power, this pin implements a 340μA pull-down current source.

**PROG (Pin 4):** The charge current program pin. A 1% resistor, R<sub>PROG</sub>, connected from PROG to ground programs the charge current. In constant-current charging mode, the voltage at this pin is regulated to 0.25V. The voltage on this pin sets the constant current charge current to:

$$I_{\text{CHG}} = \frac{96 \cdot V_{\text{PROG}}}{R_{\text{PROG}}} = \frac{24\text{V}}{R_{\text{PROG}}}$$

**BAT (Pin 5):** Battery connection pin. Connect the NiMH battery to this pin. At 25°C, the battery voltage is regulated to 1.5075V. This charge voltage is temperature compensated with a temperature coefficient of -2.5mV/°C.

**GND (Pin 6, Exposed Pad Pin 7):** Ground. Connect the ground pins to a suitable PCB copper ground plane for proper electrical operation. The exposed pad must be soldered to PCB ground for the rated thermal performance.

# BLOCK DIAGRAM

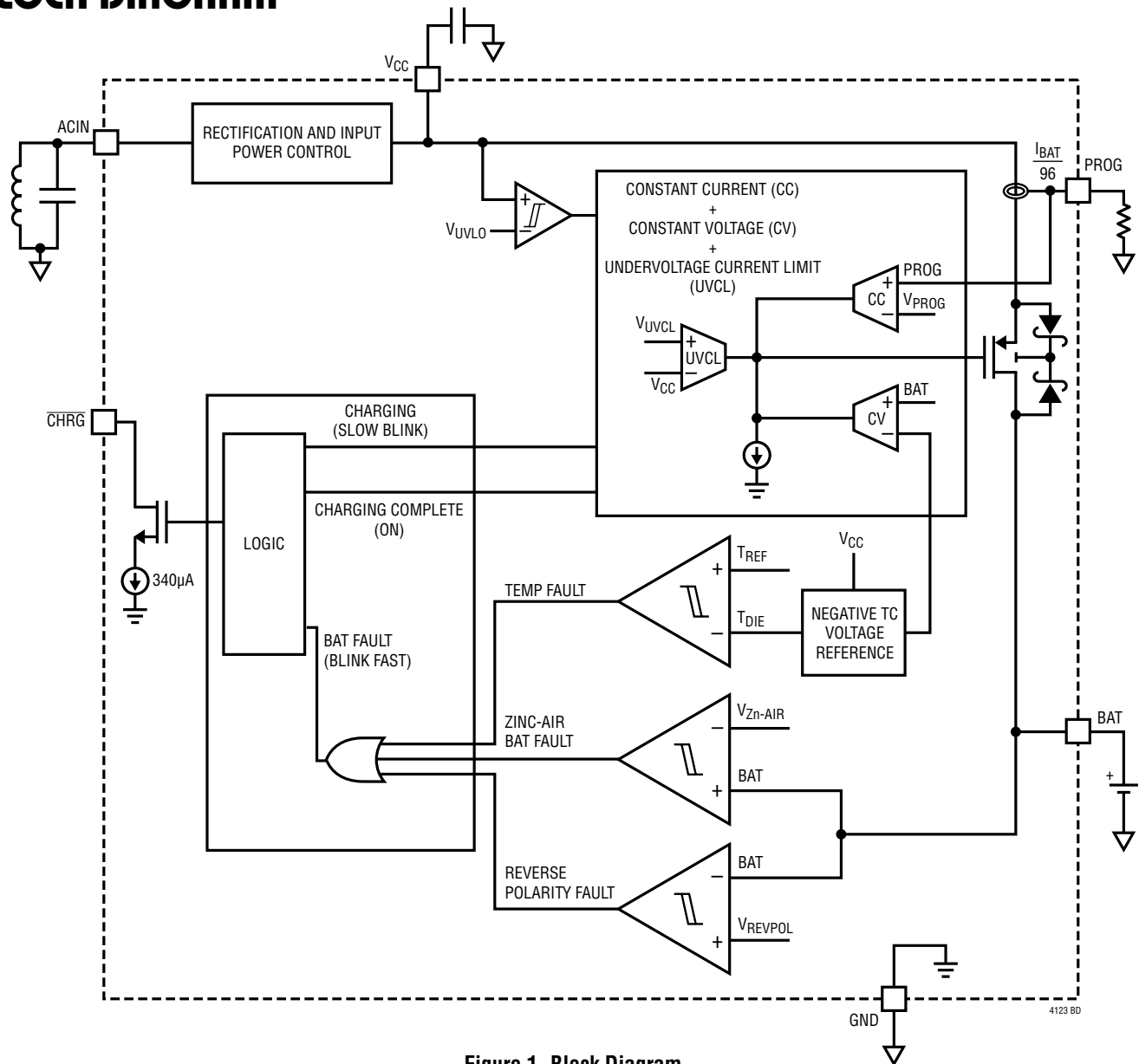

Figure 1. Block Diagram

## OPERATION

The LTC4123 is a low power battery charger designed to wirelessly charge single-cell NiMH batteries. The charger uses a constant-current/constant-voltage charge algorithm with a charge current programmable up to 25mA. The final charge voltage is temperature compensated to reach an optimum state-of-charge and prevent overcharging of the battery. The LTC4123 also guarantees the accuracy of the charge voltage to  $\pm 15\text{mV}$  from  $-5^{\circ}\text{C}$  to  $70^{\circ}\text{C}$  (see typical performance characteristics).

An external resonant LC tank connected to the ACIN pin allows the part to receive power wirelessly from an alternating magnetic field generated by a transmit coil. A complete wireless power transfer system consists of transmit circuitry, with a transmit coil, and receive circuitry, with a receive coil. The Rectification and Input Power control circuitry (Figure 1) rectifies the AC voltage at the ACIN pin and regulates the rectified voltage at  $V_{\text{CC}}$  to less than  $V_{\text{CC(HIGH)}}$  (typically 5V).

An LED can be connected to the  $\overline{\text{CHRG}}$  pin to indicate the status of the charge cycle and any fault conditions. An internal thermal limit will stop charging and pause the 6-hour charge timer if the die temperature rises above  $70^{\circ}\text{C}$  or falls below  $-5^{\circ}\text{C}$ .

In a typical charge cycle (see Figure 2), the 6-hour charge timer will begin when the part is powered. At the beginning of the charge cycle, the LTC4123 will determine if the battery is connected in reverse or if a Zinc-Air battery is connected to the BAT pin. If any of the above fault conditions is true, the BAT pin goes to a high impedance state and charging is stopped immediately. An LED connected to  $\overline{\text{CHRG}}$  will blink fast (typically at 6Hz). If the battery is a NiMH battery inserted with correct polarity, it will continue to charge at the programmed current level in constant-current mode and CHRG will blink slowly (typically at 0.8Hz).

When the BAT pin approaches the final charge voltage, the LTC4123 enters constant-voltage mode and the charge

current begins to drop. The charge current will continue to drop and the BAT pin voltage will be maintained at the proper charge voltage. After the charge termination timer expires, charge current ceases and the BAT pin assumes a high impedance state. Once the charge cycle terminates, the  $\overline{\text{CHRG}}$  pin stops blinking and assumes a pull-down state. To start a new charge cycle, remove the input voltage at ACIN or  $V_{\text{CC}}$  and reapply it.

### Input Voltage Qualification

An internal undervoltage lockout (UVLO) circuit monitors the input voltage at  $V_{\text{CC}}$  and disables the LTC4123 until  $V_{\text{CC}}$  rises above  $V_{\text{UVLO}}$  (typically 1.95V). The UVLO circuit has a built-in hysteresis of approximately 40mV. During undervoltage conditions, maximum battery drain current is  $I_{\text{BAT(LEAK)}}$  (100nA maximum).

The LTC4123 also includes undervoltage current limiting (UVCL) that prevents charging at the programmed current until the input supply voltage is above  $V_{\text{UVCL}}$  (typically 2.2V). UVCL is particularly useful in situations when the wireless power available is limited. Without UVCL if the magnetic coupling between the receive coil and transmit coil is low, UVLO could be easily tripped if the charger tries to provide the full charge current. UVLO forces the charge current to zero, which allows the supply voltage to rise above the UVLO threshold and switch on the charger again. This oscillatory behavior will result in intermittent charging. The UVCL circuitry prevents this undesirable behavior.

### Battery Fault Conditions

The LTC4123 detects the presence of Zinc-Air batteries at the beginning of the charge cycle. Initially, the LTC4123 will charge the battery at full charge current and if the BAT pin rises above  $V_{\text{Zn-AIR}}$  (typically 1.65V) in  $T_{\text{Zn-AIR}}$  (typically 80 seconds) or less from the start of the charge timer, the LTC4123 determines the battery connected is a Zinc-Air battery and charging is disabled immediately. The charging cycle continues normally otherwise. The



# OPERATION

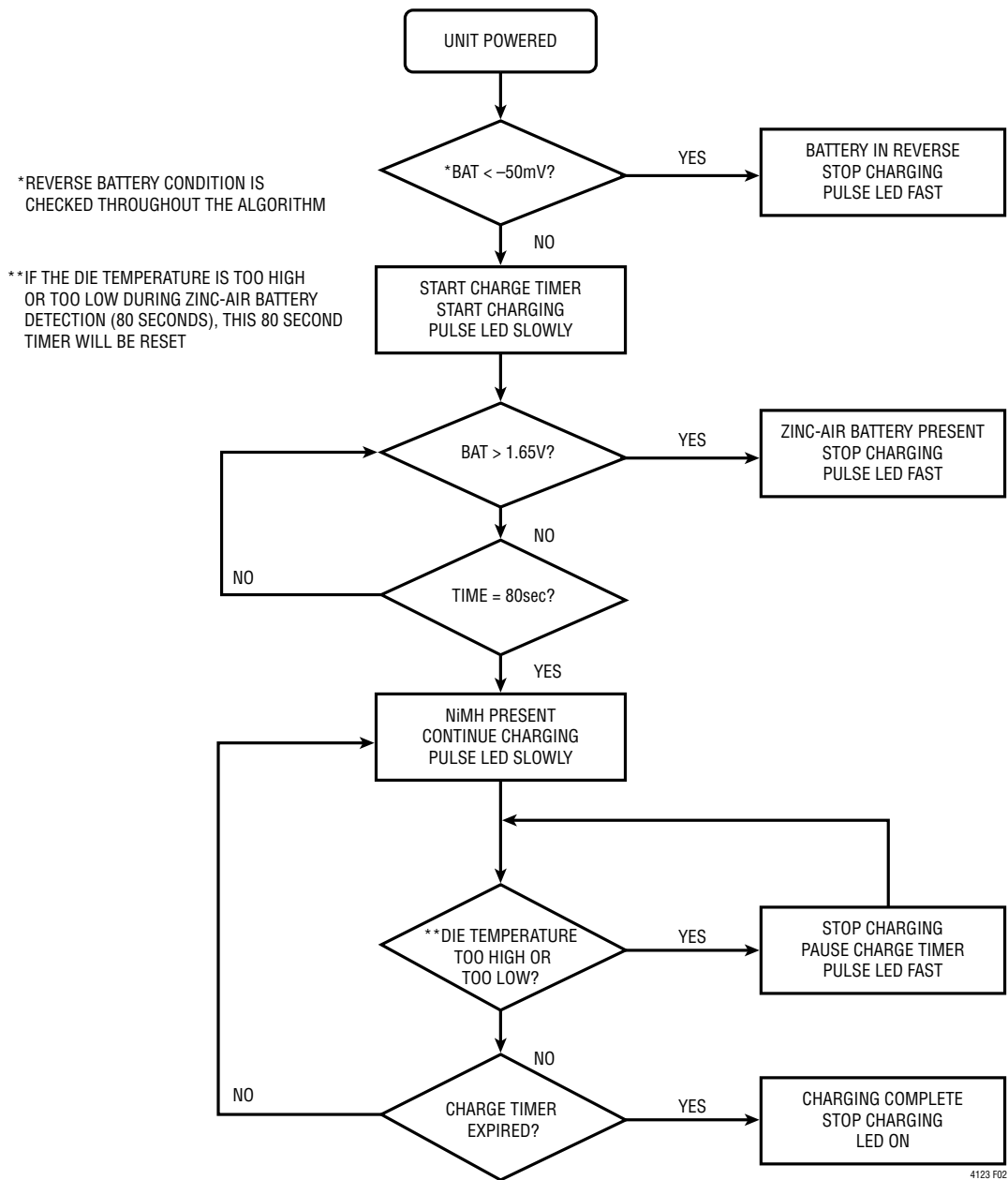

ALL THE VALUES LISTED ABOVE ARE TYPICAL.  
SEE ELECTRICAL CHARACTERISTICS TABLE FOR MORE INFORMATION

Figure 2. Charge Algorithm

## OPERATION

charge resistance of a Zinc-Air battery is higher than a NiMH battery and therefore the battery voltage of Zinc-Air rises significantly. An LED connected to  $\overline{\text{CHRG}}$  will blink fast indicating a battery fault condition.

If the LTC4123 is in UVCL mode at the beginning of the charge cycle (typically 3 seconds after power is first applied), it is unable to provide full charge current to perform Zinc-Air battery detection. In this case, a battery fault will be indicated at  $\overline{\text{CHRG}}$  (blink fast). Adjust the magnetic coupling between the receive and transmit coils to restart the charging cycle.

When a battery is inserted in reverse or the die temperature is above 70°C or below -5°C, an LED connected to  $\overline{\text{CHRG}}$  will blink fast. Table 1 summarizes the four different possible states of the  $\overline{\text{CHRG}}$  pin when the charger is active.

**Table 1.  $\overline{\text{CHRG}}$  Pin Status Summary**

$\overline{\text{CHRG}}$ Blink Frequency	Charge Status
On (Pull-Down)	Charging complete
Blink Slow (0.8Hz)	Charging
Blink Fast (6Hz)	Fault-No Charging; Temperature Fault/ Battery in Reverse/Zinc-Air Battery Present/UVCL at the beginning of charge cycle
Off (High Impedance)	No power/No Charging

### Operation without Wireless Power

LTC4123 can be powered by connecting a DC voltage source to the  $V_{\text{CC}}$  pin instead of receiving power wirelessly through the ACIN pin. Ground the ACIN pin if an input supply voltage is connected to  $V_{\text{CC}}$ .

## APPLICATIONS INFORMATION

### Wireless Power Transfer

In a wireless power transfer system, power is transmitted using an alternating magnetic field. An AC current in the transmit coil generates a magnetic field. When the receive coil is placed in this field, an AC current is induced in the receive coil. The AC current induced at the receive coil is a function of the applied AC current at the transmitter, and the magnetic coupling between the transmit and receive coils. The LTC4123 internal diode rectifies the AC voltage at the ACIN pin.

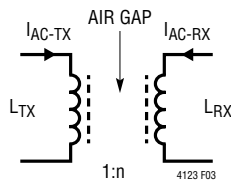

Figure 3. Wireless Power Transfer System

The power transmission range across the air gap can be improved using resonance by connecting an LC tank to the ACIN pin tuned to the same frequency as the transmit coil AC current frequency.

### Receiver and Single Transistor Transmitter

The Single Transistor Transmitter shown in Figure 4 is an example of a DC/AC converter that can be used to drive AC current into a transmit coil,  $L_{TX}$ .

The NMOS, M1, is driven by a 50% duty cycle square wave generated by the LTC6990 oscillator. During the first half of the cycle, M1 is switched on and the current through  $L_{TX}$  rises linearly. During the second half of the cycle, M1 is switched off and the current through  $L_{TX}$  circulates through the LC tank formed by  $C_{TX}$  and  $L_{TX}$ . The current through  $L_{TX}$  is shown in Figure 5.

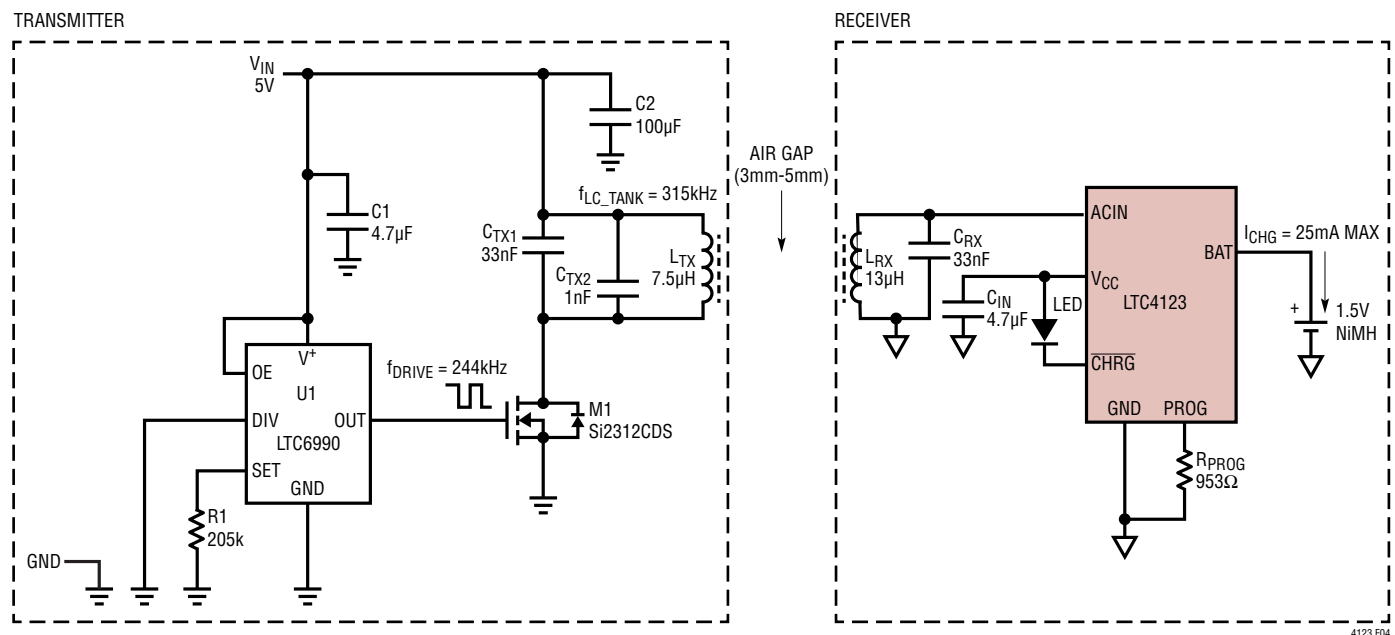
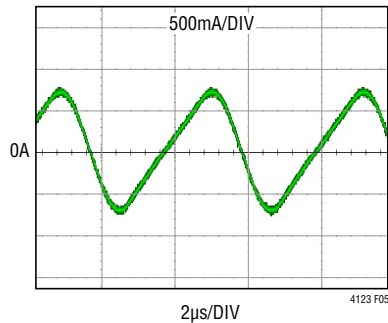
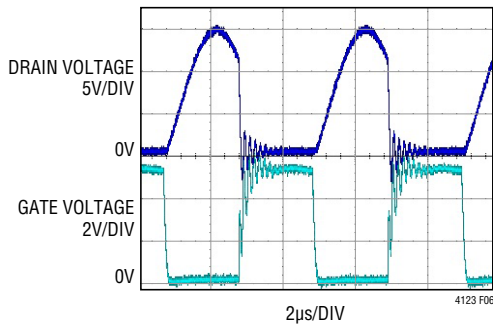

Figure 4. DC/AC Converter, Transmit/Receive Coils, Tuned Resonant LTC4123 Receiver

## APPLICATIONS INFORMATION



**Figure 5. Current Through Transmit Coil,  $L_{TX}$ , in Transmitter**



**Figure 6. Voltage on the Drain and Gate of NMOS, M1, when  $f_{TX\_TANK} = f_{DRIVE}$**

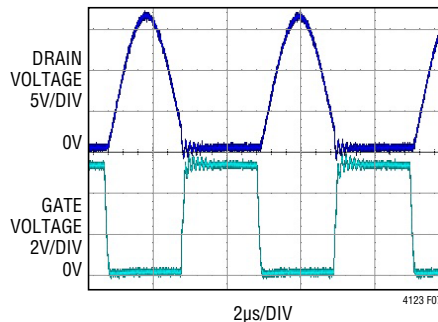

**Figure 7. Voltage on the Drain and Gate of NMOS, M1, when  $f_{TX\_TANK} = 1.29 \cdot f_{DRIVE}$**

If the transmit LC tank frequency is set to 1.29 times the driving frequency, switching losses in M1 are significantly reduced due to zero voltage switching (ZVS). Figure 6 and Figure 7 illustrate the ZVS condition at different  $f_{TX-TANK}$  frequencies.

$$f_{TX-TANK} = 1.29 \cdot f_{DRIVE}$$

$f_{DRIVE}$  is set by resistor  $R_{SET}$  in LTC6990.  $f_{TX-TANK}$  is set by:

$$f_{TX-TANK} = \frac{1}{2 \cdot \pi \sqrt{L_{TX} \cdot C_{TX}}}$$

The peak voltage of the transmit coil,  $L_{TX}$ , that appears at the drain of M1 is:

$$V_{TX-PEAK} = 1.038 \cdot \pi \cdot V_{IN}$$

And the peak current through  $L_{TX}$  is:

$$I_{TX-PEAK} = \frac{0.36 \cdot V_{IN}}{f_{TX-TANK} \cdot L_{TX}}$$

And the RMS current through  $L_{TX}$  is:

$$I_{TX-RMS} = 0.66 \cdot I_{TX-PEAK}$$

The LC tank at the receiver,  $L_{RX}$  and  $C_{RX}$ , is tuned to the same frequency as the driving frequency of the transmit LC tank:

$$f_{RX-TANK} = f_{DRIVE}$$

where  $f_{RX-TANK}$  is given by,

$$f_{RX-TANK} = \frac{1}{2 \cdot \pi \sqrt{L_{RX} \cdot C_{RX}}}$$

Note:  $f_{DRIVE}$  can be easily adjusted therefore it is best practice to choose  $f_{RX-TANK}$  using minimum component count (i.e.  $C_{RX}$ ) then adjusting  $f_{DRIVE}$  to match.

The amount of AC current in the transmit coil can be increased by increasing the supply voltage ( $V_{IN}$ ), decreasing the driving frequency ( $f_{DRIVE}$ ), or decreasing the inductance ( $L_{TX}$ ) of the transmit coil. Since the amount of power transmitted is proportional to the AC current in the transmit coil,  $V_{IN}$ ,  $f_{DRIVE}$  and  $L_{TX}$  can be varied to adjust the power delivery to the receive coil.

## APPLICATIONS INFORMATION

The overall power transfer efficiency is also dependent on the quality factor (Q) of the components used in the transmitter and receiver circuitry. Select components with low resistance for transmit/receive coils and capacitors.

### Choosing Transmit Power Level

As discussed in the previous section, several parameters can be used to adjust the transmit power of the transmitter shown in Figure 4. These include the supply voltage, ( $V_{IN}$ ), the driving frequency ( $f_{DRIVE}$ ) and the inductance of the transmit coil ( $L_{TX}$ ). Transmit power should be set as low as possible to receive the desired output power at worst-case coupling conditions (e.g. maximum transmit distance with the worst-case misalignment). Increased transmit power can deliver more power to the LTC4123-based receiver, but care must be taken not to exceed the rated current of the transmit coil. Furthermore, the LTC4123 has the ability to shunt excess received power, but this will start to increase the temperature of the LTC4123. Since the LTC4123 die temperature is assumed to be approximately equal to the battery temperature, it is important to minimize the die temperature rise to maintain an accurate battery charge voltage.

Using the rated current of the transmit inductor to set an upper limit, transmit power should be adjusted downward until charge current is negatively impacted at worst-case coupling conditions. Charge current can easily be monitored using the PROG pin voltage.

Once the transmit power level is determined, the transmit and receive coils should be arranged under best-case coupling conditions with a fully-charged battery or a battery simulator. In this scenario, the LTC4123 will shunt excess power. Measure the LTC4123 temperature using an infrared sensor or use the negative temperature coefficient of the battery charge voltage as an indication of temperature. Charge voltage measured under the best-case coupling condition should be within ten to fifteen millivolts of the charge voltage measured under worst-case coupling conditions (given the same battery current).

### Single Transistor Transmitter and LTC4123 Receiver – Design Example

The example in Figure 4 illustrates the design of the resonant coupled single transistor transmitter and LTC4123 charger. The steps needed to complete the design are reviewed below.

1. Set the charge current for the LTC4123: In this example, the charge current required is 25mA:

$$R_{PROG} = \frac{24V}{25mA} = 960\Omega$$

Since 960 $\Omega$  is not a standard 1% value, a 953 $\Omega$  resistor with a 1% tolerance is selected to obtain a charge current within 1% of the desired value.

2. Determine the receiver resonant frequency and set component values for the receiver LC tank:

It is best practice to select a resonant frequency that yields a low component count. In this example, 244kHz is selected as the receiver resonant frequency. At 244kHz, the tank capacitance ( $C_{RX}$ ) required with the selected receive coil (13 $\mu$ H) is 33nF. 33nF is a standard value for capacitors, therefore the tank capacitance requires only one component. The tank capacitance calculation is shown below.

$$C_{RX} = \frac{1}{4 \cdot \pi^2 \cdot f_{RX-TANK}^2 \cdot L_{RX}} = 32.7nF = 33nF$$

Select a 33nF capacitor with a minimum voltage rating of 25V and 5% (or 1%) tolerance for  $C_{RX}$ . A higher voltage rating usually corresponds to a higher quality factor which is preferable. However, the higher the voltage rating, the larger the package size usually is.

3. Set the driving frequency ( $f_{DRIVE}$ ) for the Single Transistor Transmitter:

$f_{DRIVE}$  is set to the same value as the receiver resonant frequency:

$$R_{SET} = \frac{1MHz}{N_{DIV}} \cdot \frac{50k\Omega}{244kHz} = 205k\Omega$$

where  $N_{DIV} = 1$  as the DIV pin in LTC6990 is grounded. Select a 205k $\Omega$  (standard value) resistor with 1% tol-

## APPLICATIONS INFORMATION

- erance. For more information regarding the LTC6990 oscillator see the data sheet.
4. Set the LC tank component values for the single transistor transmitter: If  $f_{\text{drive}}$  is 244kHz, the transmit LC tank frequency ( $f_{\text{TX-TANK}}$ ) is:

$$f_{\text{TX-TANK}} = 1.29 \cdot 244\text{kHz} = 315\text{kHz}$$

The transmit coil ( $L_{\text{TX}}$ ) used in the example is 7.5 $\mu\text{H}$ . The value of transmit tank capacitance ( $C_{\text{TX}}$ ) can be calculated:

$$C_{\text{TX}} = \frac{1}{4 \cdot \pi^2 \cdot f_{\text{TX-TANK}}^2 \cdot L_{\text{TX}}} = 34\text{nF}$$

Since 34nF is not a standard capacitor value, use a 33nF capacitor and a 1nF capacitor in parallel to obtain a value 1% of the calculated  $C_{\text{TX}}$ . The recommended rating for  $C_{\text{TX}}$  capacitors is 50V with 5% (or 1%) tolerance.

5. Verify if the AC current through the transmit coil is well within the rated current.

In this example, the supply voltage to the basic transistor transmitter is 5V. The peak AC current through the transmit ( $L_{\text{TX}}$ ) coil can be calculated:

$$I_{\text{TX-PEAK}} = \frac{0.36 \cdot V_{\text{IN}}}{f_{\text{TX-TANK}} \cdot L_{\text{TX}}} = \frac{0.36 \cdot 5\text{V}}{315\text{kHz} \cdot 7.5\mu\text{H}} = 0.76\text{A}$$

$$\text{And } I_{\text{TX-RMS}} = 0.66 \cdot 0.76 = 0.5\text{A}$$

The rated current for the transmit coil is 1.55A (please see the Würth 760308103206 data sheet for more information). The  $I_{\text{TX-RMS}}$  calculated is well below the rated current.

Verify the transmit power level chosen does not result in excessive heating of the LTC4123. Please refer to the Choosing Transmit Power Level section for more information.

**Table 2. Recommended Components for LTC4123 Receiver**

Item	Part Description	Manufacturer/Part Number
$C_{\text{IN}}$	CAP, CHIP, X5R, 4.7 $\mu\text{F}$ , $\pm 10\%$ , 10V, 0402	Samsung Electro-Mechanics America Inc. CL05A475KP5NRNC
$L_{\text{RX}}$	13 $\mu\text{H}$ , 10mm, Receive Coil	Würth 760308101208
$C_{\text{RX}}$	CAP, CHIP, COG, 33nF, $\pm 5\%$ , 50V, 0805 or	TDK C2012C0G1H333J125AA
	CAP, CHIP, COG, 33nF, $\pm 1\%$ , 50V, 1206	MURATA GCM3195C1H333FA16D
D1	LED, 630nm, Red, 0603, SMD	Rohm Semiconductor SML-311UTT86
$R_{\text{PROG}}$	RES, CHIP, 953 $\Omega$ , $\pm 1\%$ , 1/16W, 0402	VISHAY CRCW0402953RFKED

**Table 3. Recommended Components for Single Transistor Transmitter**

Item	Part Description	Manufacturer/Part Number
C1	CAP, CHIP, X5R, 4.7 $\mu\text{F}$ , $\pm 20\%$ , 6.3V, 0402	TDK C1005X5R0J475M
C2	CAP, CHIP, X5R, 100 $\mu\text{F}$ , $\pm 20\%$ , 6.3V, 1206	MURATA GRM31CR60J107ME39L
$L_{\text{TX}}$	7.5 $\mu\text{H}$ , 28mm $\times$ 15mm, Transmit Coil	Würth 760308103206
$C_{\text{TX1}}$	CAP, CHIP, COG, 33nF, $\pm 5\%$ , 50V, 0805	TDK C2012C0G1H333J125AA
$C_{\text{TX2}}$	CAP, CHIP, COG, 1nF, $\pm 5\%$ , 50V, 0603	TDK C1608C0G1H102J080AA
M1	MOSFET, N-CH 20V, 6A, SOT-23-3	Vishay Si2312CDS-T1-GE3
$R_{\text{SET}}$	RES, CHIP, 205k $\Omega$ , $\pm 1\%$ , 1/16W, 0402	Vishay CRCW0402205KFKED
U1	IC, TimerBlox: Voltage Controlled Silicon Oscillator, 2mm $\times$ 3mm DFN	Linear Tech. LTC6990IDCB

## APPLICATIONS INFORMATION

### Component Selection for Transmitter and Receiver

To ensure optimum performance from the LTC4123 in the design example discussed in the previous section, it is recommended to use the components listed in Table 2 and Table 3 for the receiver and transmitter respectively. Select receive and transmit coil with good quality factors to improve the overall power transmission efficiency. Use ferrite to improve the magnetic coupling between transmit and receive coils and to shield the rest of the transmit and receive circuitry from the AC magnetic field. Capacitors with low ESR and low thermal coefficients such as COG ceramics should be used in receive and transmit LC tanks.

### Component Selection for $\overline{\text{CHRG}}$ Status Indicator

The LED connected at  $\overline{\text{CHRG}}$  is powered by a 340 $\mu\text{A}$  pull-down current source. Select a high efficiency LED with low forward voltage drop. Some recommended components are shown in Table 4.

**Table 4. Recommended LED**

Manufacturer/Part Number	Part Description
SML-311UTT86	Rohm Semiconductor, LED, 630nm, RED, 0603, SMD
LTST-C193KRKT-5A	Lite-On Inc. LED, RED, SMT, 0603

### Stability Considerations

The LTC4123 has three control loops: constant-current (CC), constant-voltage (CV) and undervoltage current limit (UVCL). In constant-current mode, the PROG pin is in the feedback loop. An additional pole is created by the PROG pin capacitance. Therefore, capacitance on this pin must be kept to a minimum. With no additional capacitance on the PROG pin, the LTC4123 charger is stable with program resistor values as high as 23.7k $\Omega$ . However, any additional capacitance on the PROG pin limits the minimum allowed charge current.

In UVCL mode, the  $V_{\text{CC}}$  pin is in the feedback loop. Any series resistance from the supply to the  $V_{\text{CC}}$  pin and the decoupling capacitor at  $V_{\text{CC}}$  pin will create an additional

pole. The series resistance at the  $V_{\text{CC}}$  pin is highly variable and is dependent on the LC tank connected at the ACIN pin. The LTC4123 is internally compensated to operate with 1 $\mu\text{F}$  to 10 $\mu\text{F}$  decoupling capacitor and/or up to 100 $\Omega$  to 10k $\Omega$  equivalent series resistance from the supply to the  $V_{\text{CC}}$  pin.

### Zinc-Air Battery Detection

During Zinc-Air battery detection, the full programmed charge current is applied to the battery for up to 80 ( $T_{\text{Zn-AIR}}$ ) seconds after the charger is powered on. The full programmed charge current is necessary to perform successful Zinc-Air battery detection.

Upon initial application of input power, if the charger is unable to provide the programmed charge current, it signals a fault mode and the LED at  $\overline{\text{CHRG}}$  will blink fast. For instance, the programmed charge current could drop at the beginning of the charge cycle due to misalignment between transmit and receive coils. To restart a charge cycle, it is necessary to remove the receiver from the transmitter's magnetic field and try again.

At colder temperatures, if multiple charge cycles are initiated with a fully-charged NiMH battery, it is possible for the LTC4123 to detect that battery as a Zinc-Air battery and signal a fault (blink fast). This is because the internal impedance of a fully-charged NiMH battery is significantly higher at colder temperatures.

### Board Layout Considerations

The  $V_{\text{CC}}$  bypass capacitor should be connected as close as possible to the  $V_{\text{CC}}$  pin. The trace connection from the ground return of the bypass capacitor to the ground return of the LC tank should be as short as possible to minimize and localize AC noise. To minimize the parasitic capacitance on the PROG pin, the trace connection from the PROG pin to the programming resistor should be as short as possible. The ground return for the resistor should be connected to GND via the exposed pad with the shortest possible trace length.





## REVISION HISTORY

REV	DATE	DESCRIPTION	PAGE NUMBER
A	07/16	Modified Charge Voltage Limit in characteristics table.	3
		Modified $\overline{\text{CHRG}}$ pin description.	6
		Modified Block Diagram of CHRG pin. Corrected polarity symbol of comparator in Block Diagram.	7
		Modified Input Voltage Qualification section.	8
		Modified Table 2 and Table 3.	14
		Modified Component Selection for $\overline{\text{CHRG}}$ Status Indicator section.	15