

# 35V/3.2A Multicell LiFePO<sub>4</sub> Step-Down Battery Charger with PowerPath and I<sup>2</sup>C Telemetry

## FEATURES

- LiFePO<sub>4</sub> Battery Charger with Termination
- Wide Charging Input Voltage Range: 4.5V to 35V
- High Efficiency Synchronous Operation
- 16-Bit Digital Telemetry System Monitors V<sub>BAT</sub>, I<sub>BAT</sub>, R<sub>BAT</sub>, T<sub>BAT</sub>, T<sub>DIE</sub>, V<sub>IN</sub>, I<sub>IN</sub>, V<sub>OUT</sub>
- Charges 1-9 Lithium Iron Phosphate Cells
- Input Undervoltage Charge Current Limit Loop
- Input MPPT for Solar Panel Inputs
- Input Current Limit Prioritizes System Load Output
- Low Loss PowerPath™
- Instant-On Operation with Discharged or Missing Battery
- JEITA Temperature Controlled Charging
- Pin Compatible with Li-Ion and SLA Versions

## APPLICATIONS

- Medical Instruments
- USB-C Power Delivery
- Industrial Handhelds
- Ruggedized Notebooks
- Tablet Computers

## DESCRIPTION

The LTC<sup>®</sup>4162-F is an advanced monolithic synchronous step-down switching battery charger and PowerPath™ manager that seamlessly manages power distribution between input sources such as wall adapters, backplanes, solar panels, etc., and a rechargeable lithium iron phosphate battery.

A high resolution measurement system provides extensive telemetry information for circuit voltages, currents, battery resistance and temperature which can all be read back over the I<sup>2</sup>C port. The I<sup>2</sup>C port can also be used to configure many charging parameters including charging voltages and currents, termination algorithms and numerous system status alerts.

The LTC4162-F can charge LiFePO<sub>4</sub> cell stacks from 1 cell to 9 cells with as much as 3.2A of charge current.

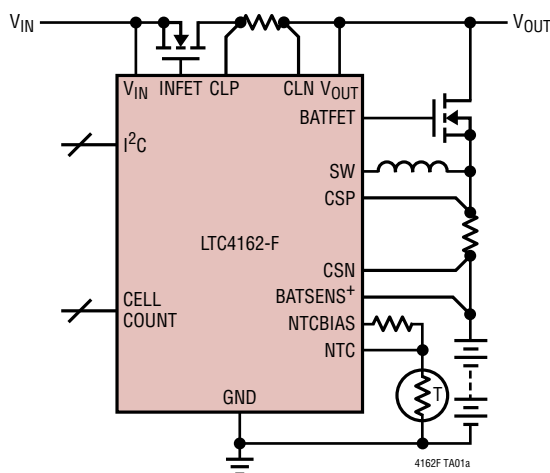
The power path topology decouples the output voltage from the battery allowing a portable product to start up instantly under very low battery voltage conditions.

The LTC4162-F is available in a thermally enhanced 28-pin 4mm × 5mm × 0.75mm QFN surface mount package.

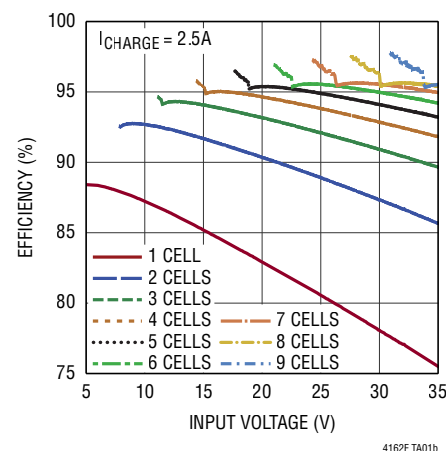
All registered trademarks and trademarks are the property of their respective owners.

## TYPICAL APPLICATION

1-9 Cell, 3.2A Step-Down Switching Battery Charger with PowerPath



Charging Efficiency vs Input Voltage by Cell Count



## TABLE OF CONTENTS

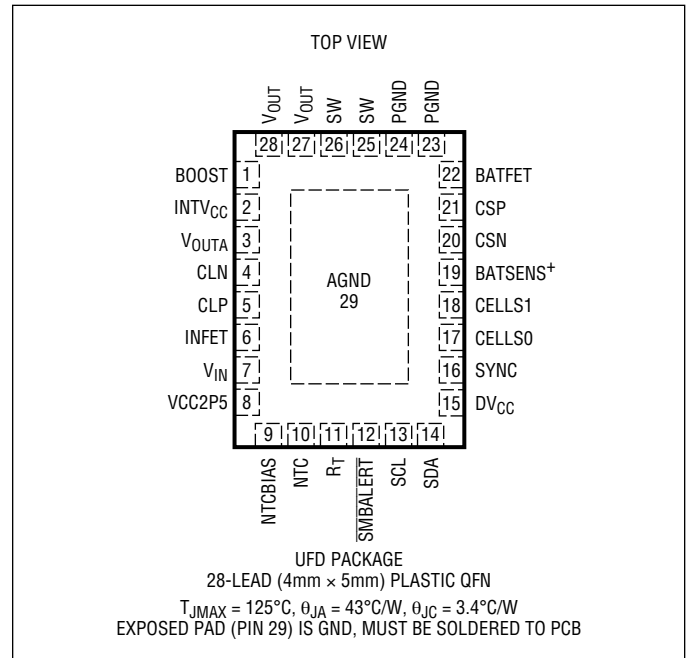
Features .....	1
Applications .....	1
Typical Application .....	1
Description.....	1
Absolute Maximum Ratings.....	3
Order Information .....	3
Pin Configuration .....	3
Electrical Characteristics.....	4
Typical Performance Characteristics .....	7
Pin Functions .....	10
Block Diagram.....	12
ESD Diagram .....	13
Timing Diagram.....	14
Operation.....	15
Applications Information .....	29
Register Descriptions .....	36
Typical Applications .....	48
Package Description .....	50
Revision History .....	51
Typical Application .....	52
Related Parts .....	52

## ABSOLUTE MAXIMUM RATINGS

(Note 1)

BATSENS+, V <sub>IN</sub> , CSP, CSN, CLP, CLN, V <sub>OUT</sub> , V <sub>OUTA</sub> .....	-0.3V to 36V
CSP to CSN, CLP to CLN.....	±0.3V
CELLSO, CELLS1, SYNC .....	-0.3V to INTVCC
DV <sub>CC</sub> .....	-0.3V to 5.5V
SDA, SCL, SMBALERT.....	-0.3V to DV <sub>CC</sub>
I <sub>SW</sub> .....	±3.5A
Operating Junction Temperature Range (Notes 2, 4).....	-40 to 125°C
Storage Temperature Range .....	-65 to 150°C

## PIN CONFIGURATION



## ORDER INFORMATION

PART NUMBER	PART MARKING*	TAPE AND REEL	TEMP GRADE	DESCRIPTION	TEMPERATURE RANGE
LTC4162EUFD-FAD#PBF	4162E		E	I <sup>2</sup> C Adjustable Voltage	-40°C to 125°C
LTC4162EUFD-FST#PBF	4162G		E	3.6V Fixed Voltage	-40°C to 125°C
LTC4162EUFD-FFS#PBF	4162F		E	3.8V Rapid Charge	-40°C to 125°C
LTC4162EUFD-FADM#PBF	4162P		E	I <sup>2</sup> C Adjustable Voltage MPPT ON	-40°C to 125°C
LTC4162EUFD-FSTM#PBF	4162S		E	3.6V Fixed Voltage MPPT ON	-40°C to 125°C
LTC4162EUFD-FFSM#PBF	4162R		E	3.8V Rapid Charge MPPT ON	-40°C to 125°C
LTC4162EUFD-FAD#TRPBF	4162E	✓	E	I <sup>2</sup> C Adjustable Voltage	-40°C to 125°C
LTC4162EUFD-FST#TRPBF	4162G	✓	E	3.6V Fixed Voltage	-40°C to 125°C
LTC4162EUFD-FFS#TRPBF	4162F	✓	E	3.8V Rapid Charge	-40°C to 125°C
LTC4162EUFD-FADM#TRPBF	4162P	✓	E	I <sup>2</sup> C Adjustable Voltage MPPT ON	-40°C to 125°C
LTC4162EUFD-FSTM#TRPBF	4162S	✓	E	3.6V Fixed Voltage MPPT ON	-40°C to 125°C
LTC4162EUFD-FFSM#TRPBF	4162R	✓	E	3.8V Rapid Charge MPPT ON	-40°C to 125°C
LTC4162IUFD-FAD#PBF	4162E		I	I <sup>2</sup> C Adjustable Voltage	-40°C to 125°C
LTC4162IUFD-FST#PBF	4162G		I	3.6V Fixed Voltage	-40°C to 125°C
LTC4162IUFD-FFS#PBF	4162F		I	3.8V Rapid Charge	-40°C to 125°C
LTC4162IUFD-FADM#PBF	4162P		I	I <sup>2</sup> C Adjustable Voltage MPPT ON	-40°C to 125°C

## ORDER INFORMATION

PART NUMBER	PART MARKING*	TAPE AND REEL	TEMP GRADE	DESCRIPTION	TEMPERATURE RANGE
LTC4162IUFD-FSTM#PBF	4162S		I	3.6V Fixed Voltage MPPT ON	-40°C to 125°C
LTC4162IUFD-FFSM#PBF	4162R		I	3.8V Rapid Charge MPPT ON	-40°C to 125°C
LTC4162IUFD-FAD#TRPBF	4162E	✓	I	I <sup>2</sup> C Adjustable Voltage	-40°C to 125°C
LTC4162IUFD-FST#TRPBF	4162G	✓	I	3.6V Fixed Voltage	-40°C to 125°C
LTC4162IUFD-FFS#TRPBF	4162F	✓	I	3.8V Rapid Charge	-40°C to 125°C
LTC4162IUFD-FADM#TRPBF	4162P	✓	I	I <sup>2</sup> C Adjustable Voltage MPPT ON	-40°C to 125°C
LTC4162IUFD-FSTM#TRPBF	4162S	✓	I	3.6V Fixed Voltage MPPT ON	-40°C to 125°C
LTC4162IUFD-FFSM#TRPBF	4162R	✓	I	3.8V Rapid Charge MPPT ON	-40°C to 125°C

Contact the factory for parts specified with wider operating temperature ranges. \*The temperature grade is identified by a label on the shipping container. [Tape and reel specifications](#). Some packages are available in 500 unit reels through designated sales channels with #TRMPBF suffix.

## ELECTRICAL CHARACTERISTICS

The ● denotes the specifications which apply over the full specified operating junction temperature range, otherwise specifications are at  $T_A = 25^\circ\text{C}$  (Note 4).  $V_{IN} = 18\text{V}$ ,  $DV_{CC} = 3.3\text{V}$ ,  $R_{SNSI} = 10\text{m}\Omega$ ,  $R_{SNSB} = 10\text{m}\Omega$  unless otherwise noted.

SYMBOL	PARAMETER	CONDITIONS	MIN	TYP	MAX	UNITS
<b>System Voltages and Currents</b>						
$V_{IN}$	Input Supply Voltage		●	4.5	35	V
$V_{BAT}$	Battery Voltage		●	2.7	35	V
$I_{BATSENS+}$	Battery Drain Current	$V_{IN} - V_{BATSENS+} > V_{IN\_DUVLO}$ , Terminated $V_{IN} - V_{BATSENS+} < V_{IN\_DUVLO}$ $V_{IN} = 0$ , SHIPMODE Activated		0.5 54 2.8	1 100 5	$\mu\text{A}$ $\mu\text{A}$ $\mu\text{A}$
$I_{VIN}$	$V_{IN}$ Drain Current	$V_{IN} - V_{BATSENS+} > V_{IN\_DUVLO}$ , Terminated		115	200	$\mu\text{A}$
<b>Switching Battery Charger</b>						
$V_{CHARGE}$	Range Resolution (5 Bits) Accuracy	Per <a href="#">cell_count</a>	●	3.4125–3.8 12.5		V mV %
$I_{CHARGE}$ Servo Voltage ( $V_{CSP} - V_{CSN}$ )	Range Resolution (5 Bits) Accuracy	$I_{CHARGE} = (V_{CSP} - V_{CSN})/R_{SNSB}$ Note 5	●	1–32 1	0.25 0.75	mV mV mV
$I_{INLIM}$ Servo Voltage ( $V_{CLP} - V_{CLN}$ )	Range Resolution (6 Bits) Accuracy	$I_{IN} = (V_{CLP} - V_{CLN})/R_{SNSI}$ Note 6		0.5–32 0.5	0.2	mV mV mV
$V_{INLIM}$	Range Resolution (8 Bits) Full Scale Accuracy			0.14–36 140.625	1	V mV %

**ELECTRICAL CHARACTERISTICS** The ● denotes the specifications which apply over the full specified operating junction temperature range, otherwise specifications are at  $T_A = 25^\circ\text{C}$  (Note 4).  $V_{IN} = 18\text{V}$ ,  $DV_{CC} = 3.3\text{V}$ ,  $R_{SNSI} = 10\text{m}\Omega$ ,  $R_{SNSB} = 10\text{m}\Omega$  unless otherwise noted.

SYMBOL	PARAMETER	CONDITIONS	MIN	TYP	MAX	UNITS
$f_{OSC}$	Switching Frequency	$R_T = 63.4\text{k}$	● 1.4	1.5	1.6	MHz
$D_{MAX}$	Maximum Duty Cycle			99.5		%
$R_{SWITCH}$	Primary Switch On-Resistance			90		$\text{m}\Omega$
$R_{RECT}$	Rectifier Switch On-Resistance			90		$\text{m}\Omega$
$I_{PEAK}$	Peak Inductor Current Limit	Note 3		$45\text{mV}/R_{SNSB}$		A

**System Controls**

$V_{IN\_UVLO}$	$V_{IN}$ Charger Enable Input Undervoltage Lockout	Rising Threshold Hysteresis	4.2	4.4 0.2	4.6	V V
$V_{IN\_DUVLO}$	$V_{IN}$ to BATSENS+ Charger Enable Differential Undervoltage Lockout	Rising Threshold Hysteresis	100	150 170	200	mV mV
$V_{IN\_OVLO}$	$V_{IN}$ Charger Disable Overvoltage Lockout	Rising Threshold Hysteresis	37.6	38.6 1.4	40	V V
$V_{INTVCC\_UVLO}$	$INTV_{CC}$ Telemetry Enable Undervoltage Lockout	Rising Threshold Hysteresis	2.75	2.85 0.12	2.95	V V

**Telemetry A/D Measurement Subsystem**

$I_{BAT}$ ( $V_{CSP} - V_{CSN}$ )	Resolution Offset Error Span Error	$I_{BAT} = (V_{CSP} - V_{CSN})/R_{SNSB}$ $0.32\text{mV} < V_{CSP} - V_{CSN} < 32\text{mV}$	-0.15 -1	1.466	0.15 1	$\mu\text{V}/\text{LSB}$ mV %rdng
$I_{IN}$ ( $V_{CLP} - V_{CLN}$ )	Resolution Offset Error Span Error	$I_{IN} = (V_{CLP} - V_{CLN})/R_{SNSI}$ $0.32\text{mV} < V_{CLP} - V_{CLN} < 32\text{mV}$	-0.15 -1	1.466	0.15 1	$\mu\text{V}/\text{LSB}$ mV %rdng
$V_{IN}$	Resolution Offset Error Span Error	$3\text{V} < V_{IN} < 35\text{V}$	-25 -1	1.649	25 1	mV/LSB mV %rdng
$V_{BATSENS+}$ (Per <code>cell_count</code> )	Resolution Offset Error Span Error	$2\text{V} < V_{BATSENS+} < 3.8\text{V}$	-10 -1	192.4	10 1	$\mu\text{V}/\text{LSB}$ mV %rdng
$V_{OUT}$	Resolution Offset Error Span Error	$3\text{V} < V_{OUT} < 35\text{V}$	-25 -1	1.653	25 1	mV/LSB mV %rdng
$V_{NTC}/V_{NTCBIAS}$	Resolution Offset Error Span Error	$0 < V_{NTC}/V_{NTCBIAS} < 1$	-1 -1	45.833	1 1	$\mu\text{V}/\text{V}/\text{LSB}$ mV/V %rdng
$T_{die}$	Resolution Offset			0.0215 -264.4		$^\circ\text{C}/\text{LSB}$ $^\circ\text{C}$

**Serial Port, SDA, SCL, SMBALERT**

$DV_{CC}$	Logic Reference Level		● 1.8		5.5	V
$I_{DVCCQ}$	$DV_{CC}$ Current	$SCL/SDA = DV_{CC}, 0\text{kHz}$		0		$\mu\text{A}$
ADDRESS	I <sup>2</sup> C Address			0b1101000[R/W]		
$V_{IH2C}$	Input High Threshold		70			% $DV_{CC}$
$V_{IL2C}$	Input Low Threshold				30	% $DV_{CC}$
$V_{OL2C}$	Digital Output Low (SDA/SMBALERT)	$I_{SDA/SMBALERT} = 3\text{mA}$			400	mV
$F_{SCL}$	SCL Clock Frequency				400	kHz

## ELECTRICAL CHARACTERISTICS

The ● denotes the specifications which apply over the full specified operating junction temperature range, otherwise specifications are at  $T_A = 25^\circ\text{C}$  (Note 4).  $V_{IN} = 18\text{V}$ ,  $DV_{CC} = 3.3\text{V}$ ,  $R_{SNS1} = 10\text{m}\Omega$ ,  $R_{SNSB} = 10\text{m}\Omega$  unless otherwise noted.

SYMBOL	PARAMETER	CONDITIONS	MIN	TYP	MAX	UNITS
$t_{LOW}$	LOW Period of SCL Clock		1.3			$\mu\text{s}$
$t_{HIGH}$	HIGH Period of SCL Clock		0.6			$\mu\text{s}$
$t_{BUF}$	Bus Free Time Between Start and Stop Conditions		1.3			$\mu\text{s}$
$t_{HD,STA}$	Hold Time, After (Repeated) Start Condition		0.6			$\mu\text{s}$
$t_{SU,STA}$	Setup Time after a Repeated Start Condition		0.6			$\mu\text{s}$
$t_{SU,STO}$	Stop Condition Set-Up Time		0.6			$\mu\text{s}$
$t_{HD,DAT(OUT)}$	Output Data Hold Time		0		900	ns
$t_{HD,DAT(IN)}$	Input Data Hold Time		0			ns
$t_{SU,DAT}$	Data Set-Up Time		100			ns
$t_{SP}$	Input Spike Suppression Pulse Width				50	ns
<b>SYNC Pin</b>						
VIHSYNC	Input High Threshold	●	1.5			V
VILSYNC	Input Low Threshold	●			0.2	V
<b>Pin Leakages (NTC, CELLS0, CELLS1, SDA, SCL, SYNC, SMBALERT)</b>						
	Pin Current		-50		50	nA

**Note 1:** Stresses beyond those listed under Absolute Maximum Ratings may cause permanent damage to the device. Exposure to any Absolute Maximum Rating condition for extended periods may affect device reliability and lifetime.

**Note 2:** The LTC4162 includes over-temperature protection that is intended to protect the device during momentary overload conditions. The maximum rated junction temperature will be exceeded when this protection is active. Continuous operation above the specified absolute maximum operating junction temperature may impair device reliability or permanently damage the device.

**Note 3:** The safety current limit features of this part are intended to protect the IC from short term or intermittent fault conditions. Continuous operation above the maximum specified pin current may result in device degradation or failure.

**Note 4:** The E-grade is tested under pulsed load conditions such that  $T_J \approx T_A$ . The E-grade is guaranteed to meet specifications from  $0^\circ\text{C}$  to  $85^\circ\text{C}$  junction temperature. Specifications over the  $-40^\circ\text{C}$  to  $125^\circ\text{C}$

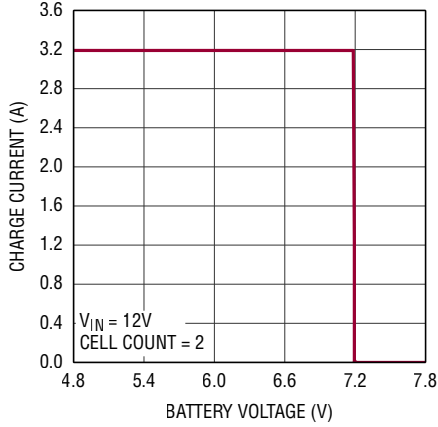
operating junction temperature range are assured by design, characterization, and correlation with statistical process controls. The I-grade is guaranteed over the full  $-40^\circ\text{C}$  to  $125^\circ\text{C}$  operating junction temperature range. The junction temperature ( $T_J$ ) is calculated from the ambient temperature ( $T_A$ ) and power dissipation ( $P_D$ ) according to the formula  $T_J = T_A + (P_D \cdot \theta_{JA})$ . Note that the maximum ambient temperature consistent with these specifications is determined by specific operating conditions in conjunction with board layout, the rated package thermal resistance and other environmental factors.

**Note 5:** Charge Current is given by the charger servo voltage,  $V_{CSP-CSN}$ , divided by the charge current setting resistor  $R_{SNSB}$ . Errors in the value of the external resistor contribute directly to the total charge current error.

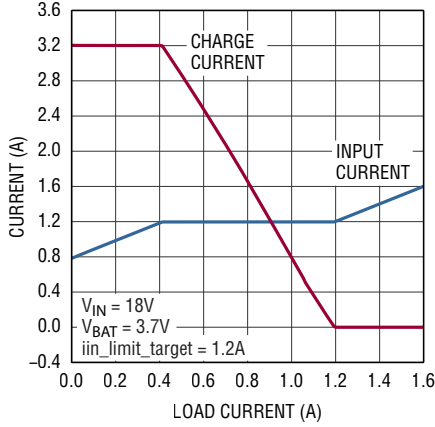
**Note 6:** Input Current is given by the  $V_{CLP-CLN}$  servo voltage divided by the input current setting resistor  $R_{SNS1}$ . Errors in the value of the external resistor contribute directly to the total input current error.

**TYPICAL PERFORMANCE CHARACTERISTICS**  $T_A = 25^\circ\text{C}$ , unless otherwise noted.

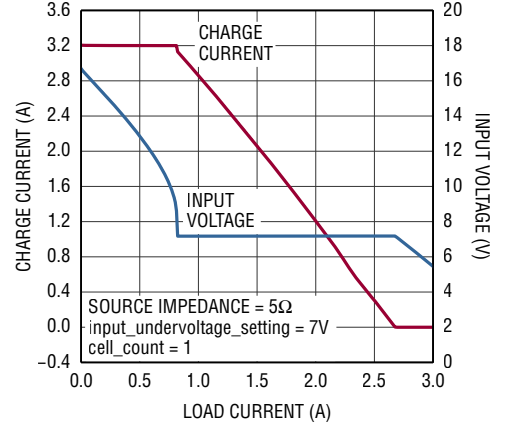
**Charge Current vs Battery Voltage**



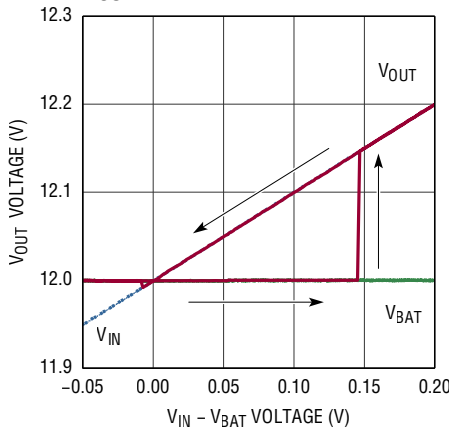
**Input Current and Charge Current vs Load Current**



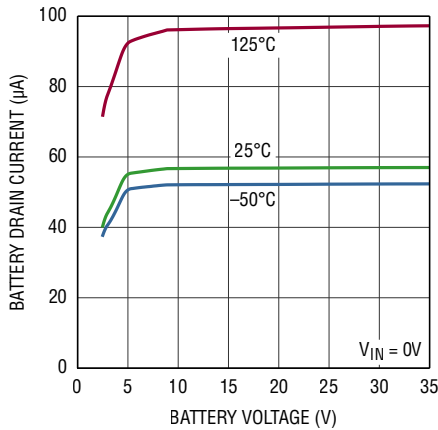
**Resistive Source Input Voltage and Charge Current vs Load Current**



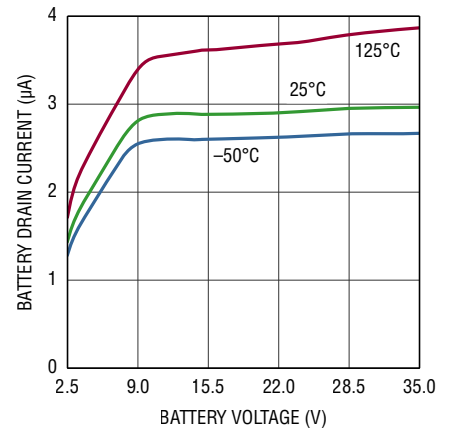
**$V_{OUT}$  vs  $V_{IN}$  Power Path Controller**



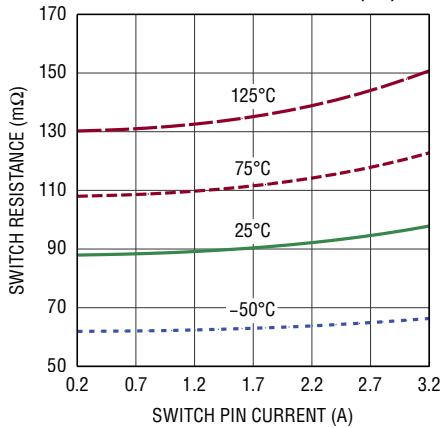
**No Input Battery Drain Current vs Battery Voltage**



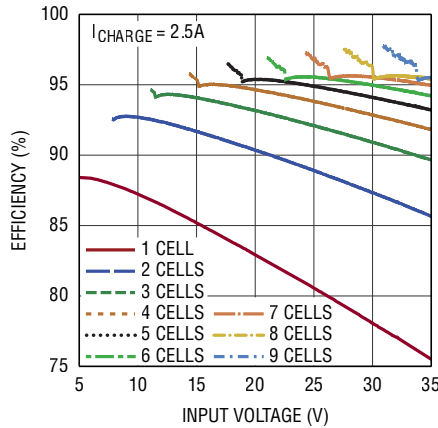
**Ship Mode Battery Drain Current vs Battery Voltage**



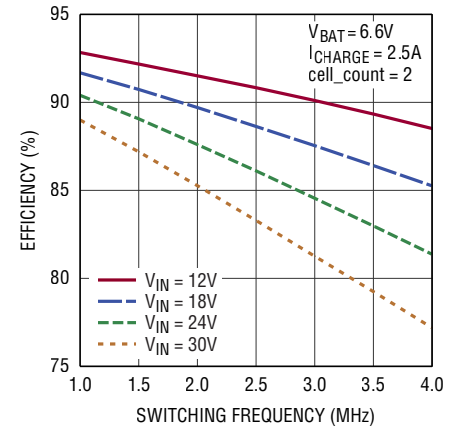
**Top and Bottom Switch  $R_{DS(ON)}$**



**Efficiency vs Input Voltage**

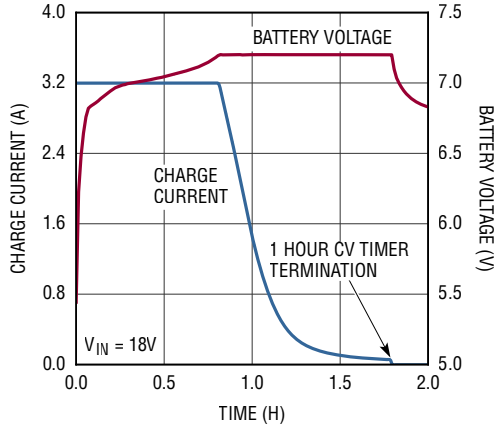


**Efficiency vs Switching Frequency**



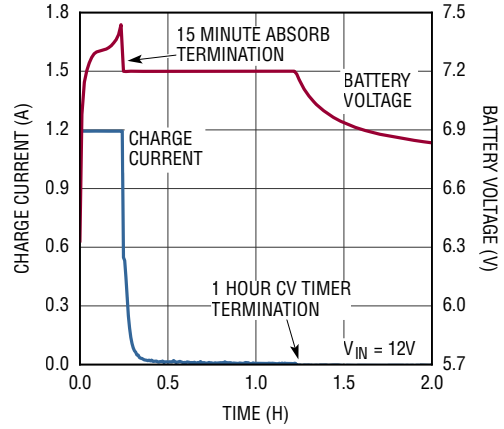
## TYPICAL PERFORMANCE CHARACTERISTICS $T_A = 25^\circ\text{C}$ , unless otherwise noted.

### 3.3Ah 2-Cell Battery Charge Current and Voltage vs Time



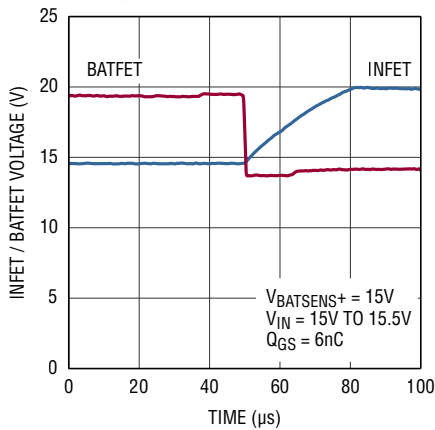
4162F G10

### 400mAh 2-Cell Battery Rapid Charge Current and Voltage vs Time



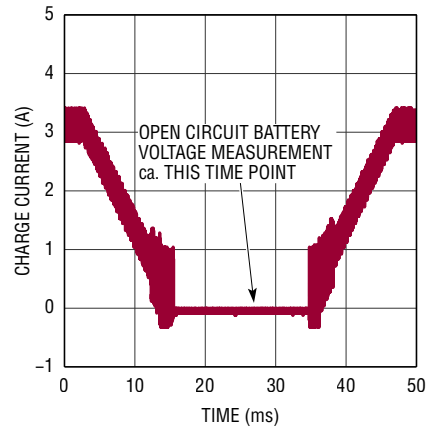
4162F G11

### Example Power Path Handover



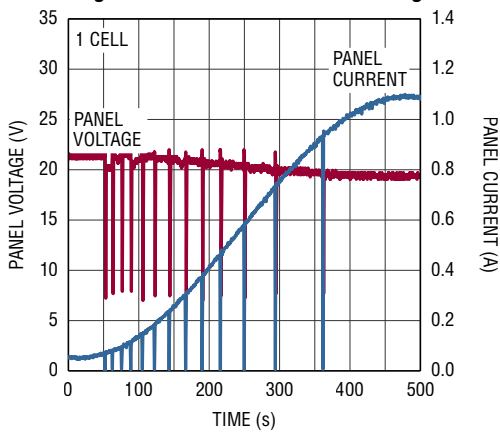
4162F G12

### Charge Current During BSR Measurement Cycle



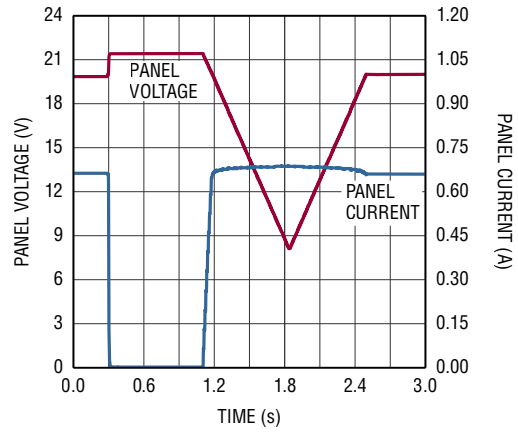
4162F G13

### Light to Dark Solar Panel Tracking



4162F G14

### Solar Panel Global Sweep

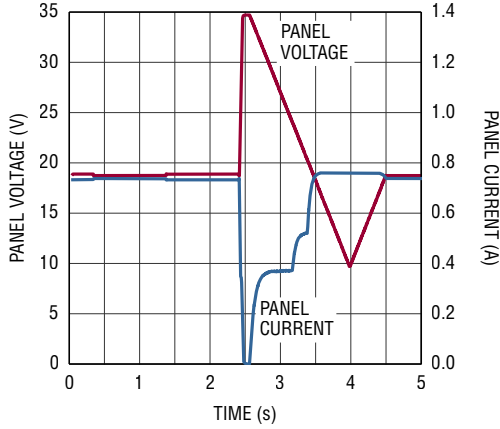


4162F G15

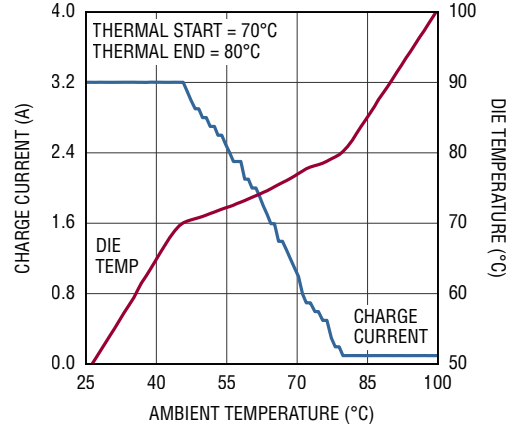


**TYPICAL PERFORMANCE CHARACTERISTICS**  $T_A = 25^\circ\text{C}$ , unless otherwise noted.

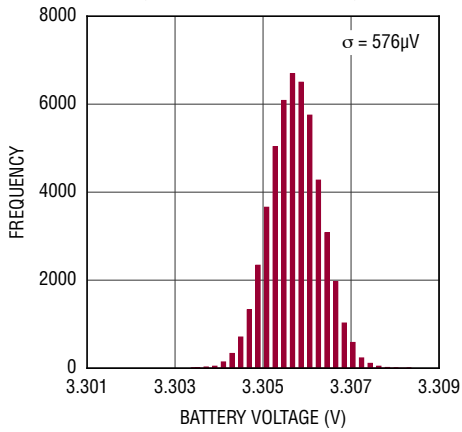
**Multi-Peak Solar Panel Acquisition**



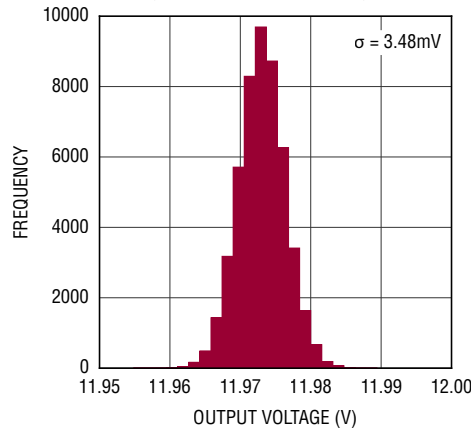
**Charge Current and Die Temperature Using Thermal Regulation**



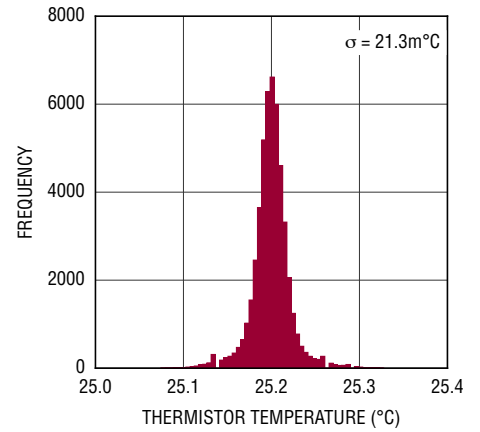
**Histogram of vbat Readings**



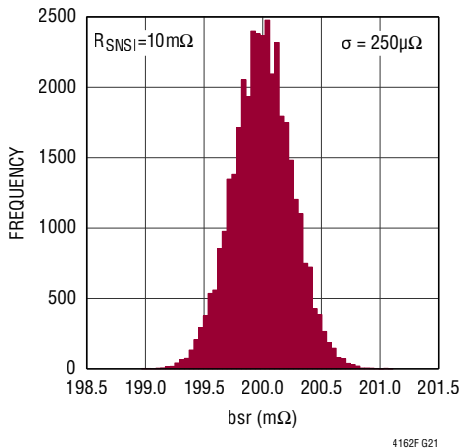
**Histogram of vout Readings**



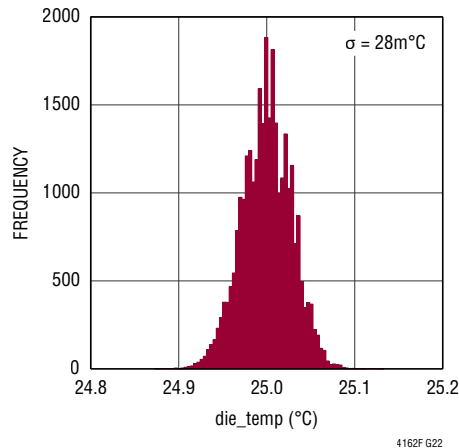
**Histogram of thermistor\_voltage Readings**



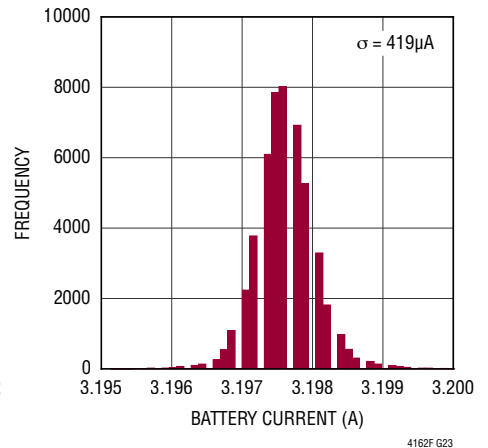
**Histogram of bsr Readings**



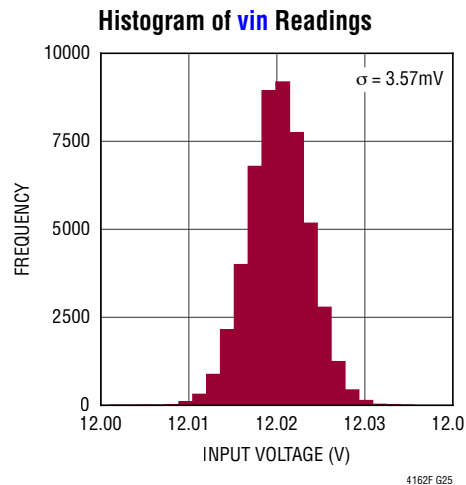
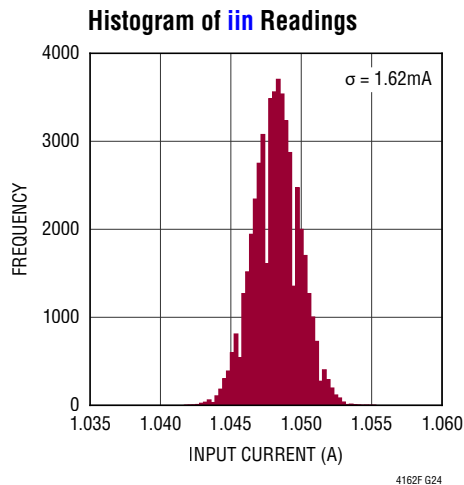
**Histogram of die\_temp Readings**



**Histogram of ibat Readings**



## TYPICAL PERFORMANCE CHARACTERISTICS $T_A = 25^\circ\text{C}$ , unless otherwise noted.



## PIN FUNCTIONS

**BOOST (Pin 1):** Gate-Drive bias for the high side switch in the switching regulator. This pin provides a pumped bias voltage relative to SW. The voltage on this pin is charged up through an internal diode from  $INTV_{CC}$ . A 22nF multilayer ceramic capacitor is required from SW to BOOST.

**$INTV_{CC}$  (Pin 2):** Bypass pin for the internal 5V regulator. This regulator provides power to the internal analog circuitry. A 4.7 $\mu\text{F}$  multilayer ceramic capacitor is required from  $INTV_{CC}$  to GND.

**$V_{OUTA}$  (Pin 3):** Analog system power pin.  $V_{OUTA}$  powers the majority of circuits on the LTC4162. A 0.1 $\mu\text{F}$  multilayer ceramic capacitor is required from  $V_{OUTA}$  to GND.

**CLN (Pin 4):** Connection point for the negative terminal of the sense resistor that measures and regulates input current by limiting charge current.

**CLP (Pin 5):** Connection point for the positive terminal of the sense resistor that measures and regulates input current by limiting charge current.

**INFET (Pin 6):** Gate control output pin for an input reverse blocking external N-channel MOSFET between  $V_{IN}$  and  $V_{OUT}$ .

**$V_{IN}$  (Pin 7):** Supply voltage detection and INFET charge pump supply for the INFET/BATFET PowerPath. When voltage at  $V_{IN}$  is detected as being high enough to charge a battery, the INFET charge-pump is activated and the BATFET charge-pump is deactivated thereby powering  $V_{OUTA}$  from the input supply through an external NMOS transistor and also starting a charge cycle. A 0.1 $\mu\text{F}$  multilayer ceramic capacitor is required from  $V_{IN}$  to GND.

**VCC2P5 (Pin 8):** Bypass pin for the internal 2.5V regulator. This regulator provides power to the internal logic circuitry. A 1 $\mu\text{F}$  multilayer ceramic capacitor is required from VCC2P5 to GND.

**NTCBIAS (Pin 9):** NTC thermistor bias output. Connect a low temperature coefficient bias resistor between NTCBIAS and NTC, and a thermistor between NTC and GND. The bias resistor should be equal in value to the nominal value of the thermistor. The LTC4162 applies 1.2V to this pin during NTC measurement and expects a thermistor  $\beta$  value of 3490K. Higher  $\beta$  value thermistors can be used with simple circuit modifications.

## PIN FUNCTIONS

**NTC (Pin 10):** Thermistor input. The NTC pin connects to a negative temperature coefficient thermistor to monitor the temperature of the battery. The voltage on this pin is digitized by the analog to digital converter to qualify battery charging and is available for readout via the I<sup>2</sup>C port. A low drift bias resistor is required from NTCBIAS to NTC and a thermistor is required from NTC to ground.

**R<sub>T</sub> (Pin 11):** Switching regulator frequency control pin. The R<sub>T</sub> pin controls the switching regulator's internal oscillator frequency by placing a resistor from R<sub>T</sub> to GND.

**SMBALERT (Pin 12):** Interrupt output. This open drain output pulls low when one or more of the programmable alerts is triggered.

**SCL (Pin 13):** Open drain clock input for the I<sup>2</sup>C port. The I<sup>2</sup>C port input levels are scaled with respect to DV<sub>CC</sub> for I<sup>2</sup>C compliance.

**SDA (Pin 14):** Open drain data input/output for the I<sup>2</sup>C port. The I<sup>2</sup>C port input levels are scaled with respect to DV<sub>CC</sub> for I<sup>2</sup>C compliance.

**DV<sub>CC</sub> (Pin 15):** Logic supply for the I<sup>2</sup>C port. DV<sub>CC</sub> sets the reference level of the SDA and SCL pins for I<sup>2</sup>C compliance. It should be connected to the same power supply as the SDA and SCL pull up resistors.

**SYNC (Pin 16):** Optional external clock input for the switching battery charger. The switching battery charger will lock to a square wave or pulse on this pin that is close to the frequency programmed by the R<sub>T</sub> pin. Ground SYNC if this feature is not needed.

**CELLS0 (Pin 17):** Cell count selection pin. Used in combination with CELLS1, this pin sets the total number of series cells to be charged. The pin should be strapped to either INTV<sub>CC</sub>, VCC2P5 or GND to represent one of three possible states. See Table 5.

**CELLS1 (Pin 18):** Cell count selection pin. Used in combination with CELLS0, this pin sets the total number of series cells to be charged. The pin should be strapped to either INTV<sub>CC</sub>, VCC2P5 or GND to represent one of three possible states. See Table 5.

**BATSENS+ (Pin 19):** Positive terminal battery sense pin. BATSENS+ should Kelvin sense the positive terminal of the battery for optimized charging. A 10μF multilayer ceramic capacitor is required from BATSENS+ to ground.

**CSN (Pin 20):** Connection point for the negative terminal of the current sense resistor used to measure and limit charge current.

**CSP (Pin 21):** Connection point for the positive terminal of the current sense resistor used to measure and limit charge current.

**BATFET (Pin 22):** Gate control pin for a reverse blocking external N-channel MOSFET between the battery and V<sub>OUT</sub>.

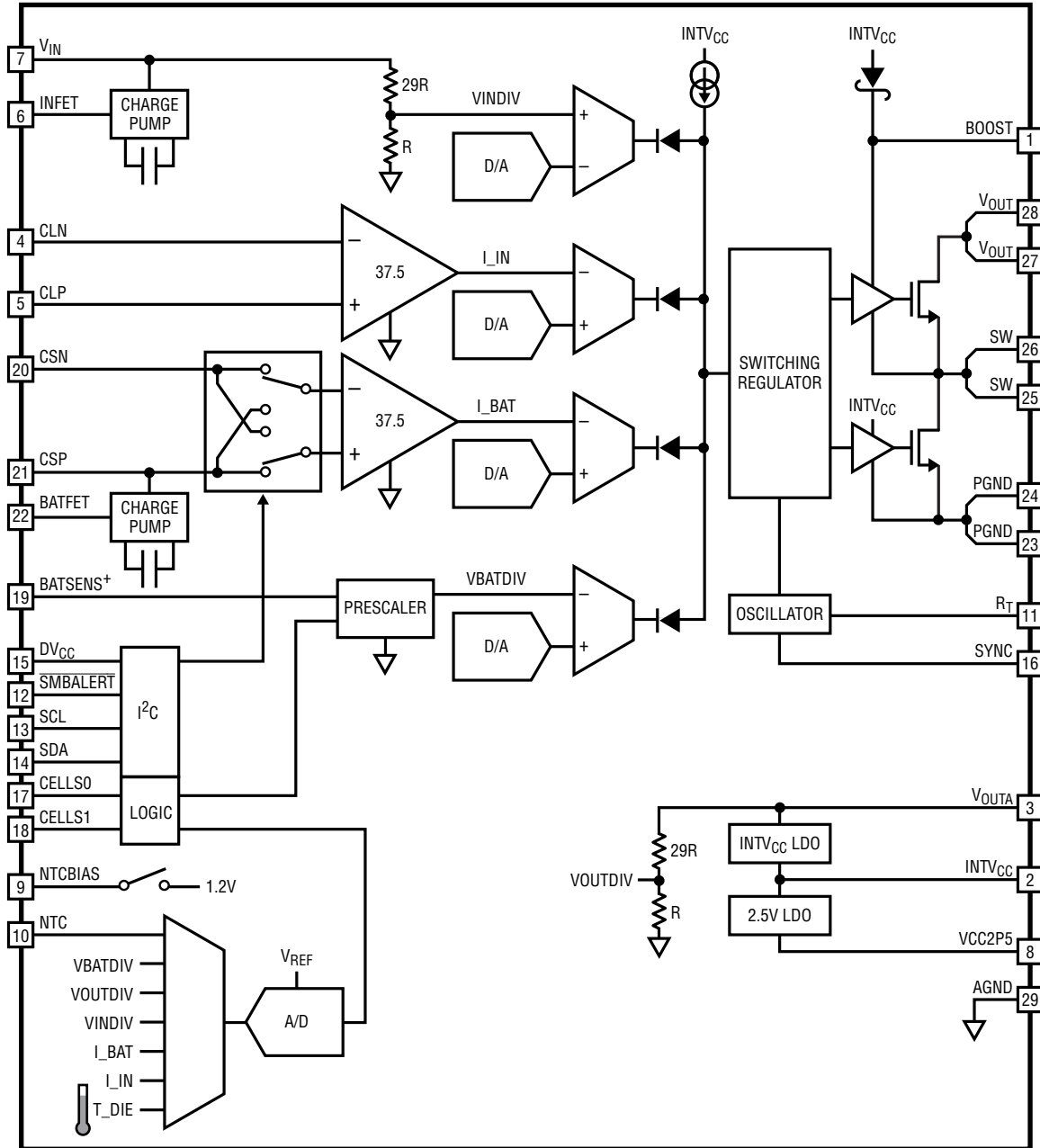
**PGND (Pins 23, 24):** Power ground pins. These pins should be connected to a copper pour that forms the return for the V<sub>OUT</sub> bypass capacitor on the top layer of the printed circuit board.

**SW (Pin 25, 26):** Switching regulator power transmission pins. The SW pins deliver power from the V<sub>OUT</sub> pins to the battery via the step-down switching regulator. An inductor should be connected from SW to a sense resistor at CSP. See the Applications Information section for a discussion of inductor value and current rating.

**V<sub>OUT</sub> (Pin 27, 28):** Switching regulator input pins. The V<sub>OUT</sub> pins deliver power to the switching charger. Having extremely high frequency current pulses, bypassing of the V<sub>OUT</sub> pins should take precedence over all other PCB layout considerations. A bypass capacitor of 10μF is a good starting point.

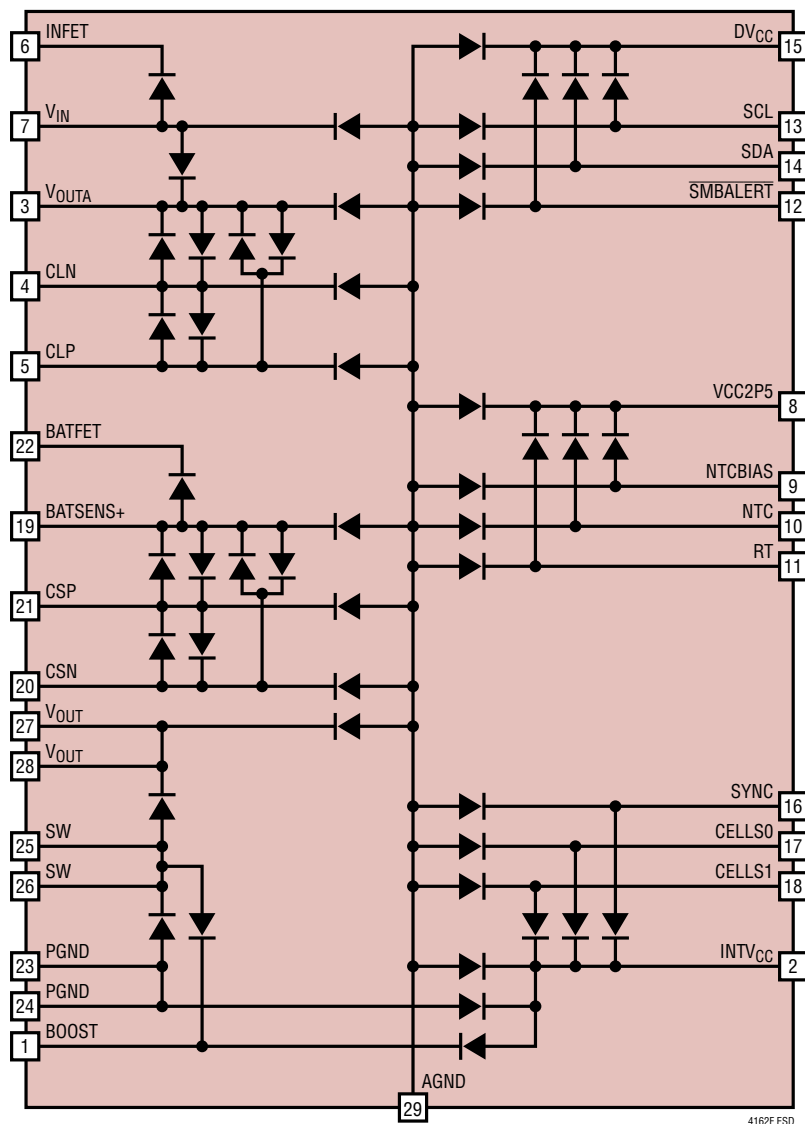
**AGND (Exposed PAD, Pin 29):** Analog ground pin. This is the ground pin used to return all of the analog circuitry inside the LTC4162 and should be connected to an analog ground pour that is common with PGND (pins 23 and 24). It should also be connected to a ground plane on layer 2 of the PCB to which all of the analog components return such as the R<sub>T</sub> resistor and the INTV<sub>CC</sub> and VCC2P5 bypass capacitors.

**BLOCK DIAGRAM**

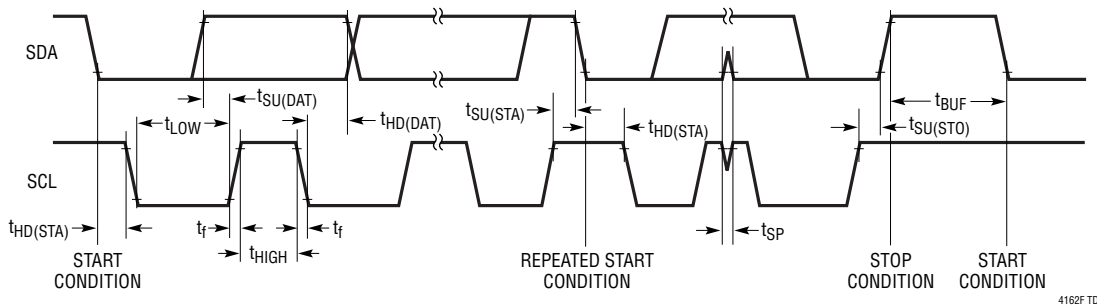


4162F BD

# ESD DIAGRAM



## TIMING DIAGRAM

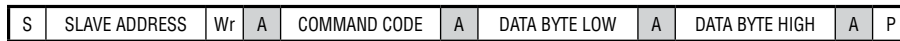


4162F TD

### I<sup>2</sup>C SMBus Legend

- S START CONDITION
- Sr REPEATED START CONDITION
- Rd READ (BIT VALUE OF 1)
- Wr WRITE (BIT VALUE OF 0)
- A ACKNOWLEDGE
- N NACK
- P STOP CONDITION
- PEC\* PACKET ERROR CODE
- MASTER TO SLAVE
- SLAVE TO MASTER

### SMBus WRITE WORD PROTOCOL



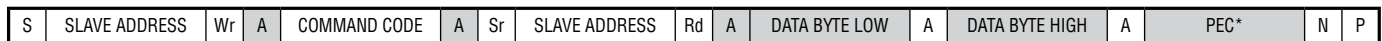
### SMBus WRITE WORD WITH PEC PROTOCOL



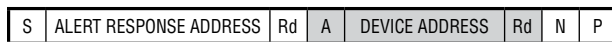
### SMBus READ WORD PROTOCOL



### SMBus READ WORD WITH PEC PROTOCOL



### SMBus ALERT RESPONSE ADDRESS PROTOCOL



### SMBus ALERT RESPONSE ADDRESS PROTOCOL WITH PEC



\*USE OF PACKET ERROR CHECKING IS OPTIONAL

## OPERATION

### Introduction

The LTC4162 is an advanced power manager and switching battery charger utilizing a high efficiency synchronous step-down switching regulator.

Using multiple feedback control signals, power is delivered from the input to the battery by a 1.5MHz constant-frequency step-down switching regulator. The switching regulator reduces output power in response to one of its four regulation loops including battery voltage, battery charge current, input current and input voltage.

The switching regulator is designed to efficiently transfer power from a variety of possible sources, such as USB ports, wall adapters and solar panels, to a battery while minimizing power dissipation and easing thermal budgeting constraints. Since a switching regulator conserves power, the LTC4162 allows the charge current to exceed the source's output current, making maximum use of the allowable power for battery charging without exceeding the source's delivery specifications. By incorporating input voltage and system current measurement and control systems, the switching charger ports seamlessly to these sources without requiring application software to monitor and adjust system loads. By decoupling the system load from the battery and prioritizing power to the system, the instant-on PowerPath architecture ensures that the system is powered upon input power arrival, even with a completely dead battery.

Two low power charge pumps drive external MOSFETs to provide low loss power paths from the input supply and battery to the system load while preventing the system node from back-driving the input supply or overcharging the battery. The power path from the battery to the system load guarantees that power is available to the system even if there is insufficient or absent power from  $V_{IN}$ . A wide range of input current settings as well as battery charge current settings are available by software control and by choosing the values of input and charge current sense resistors  $R_{SNSI}$  and  $R_{SNSB}$ .

A measurement subsystem periodically monitors and reports on a large collection of system parameters via the I<sup>2</sup>C port. An interrupt subsystem can be enabled to alert the host microprocessor of various status change events

so that system parameters can be varied as needed. All of the status change events are maskable for maximum flexibility. For example, features such as battery presence detection and battery impedance measurement are easily enabled.

To eliminate battery drain between manufacture and sale, a ship-and-store feature reduces the already low battery drain current even further.

The input undervoltage control loop can be engaged to keep the input voltage from decreasing beyond a minimum level when a resistive cable or power limited supply such as a solar panel is providing input power. A maximum power point tracking algorithm using this control loop can be deployed to maximize power extraction from solar panels and other resistive sources.

Finally, the LTC4162 has a digital subsystem that provides substantial adjustability so that power levels and status information can be controlled and monitored via the conventional I<sup>2</sup>C port.

### LTC4162 Digital System Overview

The LTC4162 contains an advanced digital system which can be accessed using the I<sup>2</sup>C port. Use of the I<sup>2</sup>C port is optional, it can be used extensively in the application or not at all, as dictated by the application requirements. Cell count, charge current, input current regulation and switching charger frequency are all externally configurable without using the I<sup>2</sup>C port. For applications requiring the LTC4162's advanced digital features, the I<sup>2</sup>C port provides a means to use status and A/D telemetry data from the measurement system, monitor charger operation, configure charger settings (e.g. charge voltage, charge current, temperature response, termination algorithm, etc), enable, disable, read and clear alerts, activate the low power ship mode, and enable/disable the battery charger.

### Power Path Controller

The LTC4162 features input and output N-channel MOSFET charge pump gate drivers. These drivers make up a dual unidirectional power path system that allows power to be delivered to the system load by either the input supply or the battery, whichever is greater. Only one of

## OPERATION

the external MOSFETs will be enabled at a time. If  $V_{IN}$  is more than 150mV above BATSENS+, the MOSFET from the input to the system load will be enabled and the one from the system load to BATSENS+ will block conduction preventing overcharging of the battery. If  $V_{IN}$  falls more than 20mV below BATSENS+ the MOSFET from the input supply to the system load will be disabled preventing reverse conduction and the MOSFET from BATSENS+ to the system load will be enabled powering downstream circuitry from the battery. It is important not to back drive  $V_{OUT}$  as one or the other of the power path MOSFETs will always be enabled.

### Step Down Switching Battery Charger

The LTC4162's battery charger is based on a very efficient synchronous step down switching regulator. As with any modern battery charger, the LTC4162 incorporates both constant-current and constant-voltage feedback control loops to prevent overcharging. The switching charger can charge either a single cell or a battery of up to nine series lithium iron phosphate cells.

Normal charging begins with a constant current until the battery reaches its target voltage. The charge current is determined by the combination of the sense resistor,  $R_{SNSB}$ , placed in series with the inductor and the servo control voltage set by either [icharge\\_jeita\\_2](#) through [icharge\\_jeita\\_6](#) with [en\\_jeita](#) set or just [charge\\_current\\_setting](#) if [en\\_jeita](#) is cleared. An internal soft-start algorithm ramps up the charge current setting from zero to its present setting. Once the battery voltage reaches the programmed voltage limit the constant-current control loop hands off to the constant-voltage control loop. The final battery voltage is set with the combination of either [vcharge\\_jeita\\_2](#) through [vcharge\\_jeita\\_6](#) with [en\\_jeita](#) set or with just [vcharge\\_setting](#) if [en\\_jeita](#) is cleared. The [cell\\_count](#), controlled by the CELLS0 and CELLS1 pins, is a charge voltage multiplier so that multiple series cells can be charged.

If [en\\_jeita](#) is set, the charge current is given by the expression:

$$I_{CHARGE} = (\text{icharge\_jeita\_x} + 1) \frac{1\text{mV}}{R_{SNSB}}$$

where [icharge\\_jeita\\_2](#) through [icharge\\_jeita\\_6](#) each range from 0 to 31.

If [en\\_jeita](#) is not set:

$$I_{CHARGE} = (\text{charge\_current\_setting} + 1) \frac{1\text{mV}}{R_{SNSB}}$$

where [charge\\_current\\_setting](#) ranges from 0 to 31.

If [en\\_jeita](#) is set, the charge voltage is given by the expression:

$$V_{CHARGE} = (3.4125\text{V} + 12.5\text{mV} \cdot \text{vcharge\_jeita\_x}) \cdot \text{cell\_count}$$

where [vcharge\\_jeita\\_2](#) through [vcharge\\_jeita\\_6](#) each range from 0 to 31.

If [en\\_jeita](#) is not set:

$$V_{CHARGE} = (3.4125\text{V} + 12.5\text{mV} \cdot \text{vcharge\_setting}) \cdot \text{cell\_count}$$

where [vcharge\\_setting](#) ranges from 0 to 31.

Beyond the conventional constant-current and constant-voltage control loops, the LTC4162 also has the ability to monitor and control both input current and input voltage, regulating battery charge power based on any one of these four control loops. Power limit is prioritized based on the lowest set-point of the group. For example, if the combined system load plus battery charge current is large enough to cause the switching charger to reach the programmed input current limit, the input current limit will reduce charge current to limit the voltage across the input sense resistor,  $R_{SNSI}$ , to the [iin\\_limit\\_target](#). Even if the charge current is programmed to exceed the allowable input current, the input current due to charge current will not be violated; the charger will reduce its current as needed. Similarly, the input voltage limit loop, controlled by [input\\_under-voltage\\_setting](#), can be used to prevent resistive power sources such as a solar panel from dragging the input voltage down below its under-voltage lockout level.

Only target values can be programmed with the I<sup>2</sup>C port. The LTC4162 uses the target values as a starting point from which the charging algorithms calculate the actual values to be applied to the DACs to support functions such as



## OPERATION

temperature compensated charge voltages and currents, maximum power point tracking, charger soft starting, etc. The target value registers are read/write whereas the actual DAC value registers, `icharge_dac`, `vcharge_dac`, `iin_limit_dac` and `input_undervoltage_dac` are read only.

Due to its all NMOS switch design, a small charge pump capacitor is required from SW to BOOST to provide high side boosted drive for the top switch.

### Input Current Regulation

Input current control limits loading on the input source during periods of high system demand by sacrificing charge current. Note that the LTC4162 only has the authority to reduce charge current to zero and cannot further reduce input current below the system load current. The input current limit is controlled by a combination of the sense resistor,  $R_{SNSI}$ , from CLP to CLN and either the default 32mV servo voltage or a lower value set by `iin_limit_target`. The servo voltage across the sense resistor divided by the resistor's value determines the input current regulation set point. A 10m $\Omega$  resistor, for example, would have an upper input current limit of 3.2A using the default 32mV servo voltage. `iin_limit_target` has 6 bit resolution giving adjustable values from 500 $\mu$ V to 32mV in 500 $\mu$ V steps and can be calculated in Amperes, by the following expression:

$$I_{NLIM} = (iin\_limit\_target + 1) \frac{500\mu V}{R_{SNSI}}$$

where `iin_limit_target` ranges from integer values of 0 to 63.

### Input Undervoltage Regulation and Solar Panel Maximum Power Point Tracking (MPPT)

The LTC4162 also contains an undervoltage control loop that allows it to tolerate a resistive connection to the input power source by automatically reducing charge current as the  $V_{IN}$  pin drops to `input_undervoltage_setting`. This circuit helps prevent UVLO oscillations by linearly regulating the input voltage above the LTC4162's undervoltage lockout level.

Optionally, the LTC4162 includes a maximum power point tracking (MPPT) algorithm to find and track the `input_undervoltage_dac` value that delivers the maximum charge current to the battery. If `mppt_en` is set, the MPPT algorithm performs a global sweep of `input_undervoltage_dac` values, measuring battery charge current at each setting. Once the sweep is complete, the LTC4162 applies the `input_undervoltage_dac` value corresponding to the maximum battery charge current `ibat` (i.e. the maximum power point). The LTC4162 then tracks small changes in the maximum power point by slowly dithering the `input_undervoltage_dac`. The LTC4162 performs a new global sweep of `input_undervoltage_dac` values every 15 minutes, applies the new maximum power point, and resumes dithering at that point. Alternatively, the global sweep will run immediately, bypassing the 15 minute wait, if `ibat` changes by more than 25%. With `mppt_en`, a solar panel can be used as a suitable power source for charging a battery and powering a load. The MPPT algorithm may not work for all solar panel applications and does not have to be used. Alternatively a solar panel can be used without the MPPT algorithm by setting the `input_undervoltage_setting` value to match the optimum loaded solar panel voltage, but significant shadows or drops in light will likely result in suboptimum power delivery.

Note that, due to the Power Path topology, current can flow from the input to the system load without being controlled by the LTC4162's switching charger. Therefore, the MPPT algorithm does not have full authority to track and find the maximum power point under all conditions. To obtain complete Maximum Power Point operation, it may be necessary to forgo the Power Path feature of the LTC4162 and connect the system load directly to the battery pack. In this configuration, the LTC4162 has full authority to track the maximum power point of the solar panel.

The input under voltage value, in Volts, will be given by the following expression:

$$V_{NLIM} = (input\_undervoltage\_setting + 1) \cdot 140.625mV$$

where `input_undervoltage_setting` ranges from integer values of 0 to 255.

## OPERATION

### System Controls

The switching battery charger can be disabled by setting [suspend\\_charger](#). This might be necessary, for instance, to pass USB Suspend compliance testing. [suspend\\_charger](#) should be used with caution as a low battery situation could prevent the system processor from being able to clear it and may require a factory service call to remove and replace the battery.

### Input Overvoltage Protection

The LTC4162 has over-voltage detection on its input. If  $V_{IN}$  exceeds approximately 38.6V as indicated by [vin\\_ovlo](#), the switching charger will stop delivering power. The charger will resume switching if  $V_{IN}$  falls below roughly 37.2V. The overvoltage detection cutoff circuit provides only modest over voltage protection and is not intended to prevent damage in all circumstances.

### Measurement Subsystem

The LTC4162 includes a 16-bit  $\Delta\Sigma$  A/D converter and signal multiplexer to monitor numerous analog parameters. It can measure the voltages at [vin](#), [vbat](#) and [vout](#), the input current (voltage between CLP and CLN), [iin](#), the battery charge current (voltage between CSP and CSN), [ibat](#), the battery pack [thermistor\\_voltage](#), its own internal [die\\_temp](#) and, once a charge cycle begins, the series resistance of the battery, [bsr](#). To save battery current, the measurement system is disabled if the battery is the only source of power ([vin\\_gt\\_vbat](#) = 0). This can be overridden with [force\\_telemetry\\_on](#). The A/D converter is automatically multiplexed between all of the measured channels and

its 16-bit signed two's complement results are stored in registers accessible via the I<sup>2</sup>C port. The seven channels measured by the ADC each take approximately 1.6ms to convert. The maximum range of the 16 bit  $\Delta\Sigma$  A/D converter is  $\pm 1.8V$  and it has an internal span term of 18191 counts per Volt. It measures each of the above parameters through different paths giving different sensitivity terms for each measurement as summarized in Table 1.

### Battery Voltage Measurement

Battery voltage is measured through a resistive voltage divider whose attenuation ratio is based on the [cell\\_count](#). The result is reported in [vbat](#). The divider ratio is  $BAT\_SENS+/(3.5 \cdot cell\_count)$  making the A/D span term  $3.5 \cdot cell\_count/18191$  or  $192.4\mu V \cdot cell\_count$  per LSB where [cell\\_count](#) varies from 1 to 9. An alert may be set on battery voltage by setting the [vbat](#) based value [vbat\\_lo\\_alert\\_limit](#) or [vbat\\_hi\\_alert\\_limit](#) and setting [en\\_vbat\\_lo\\_alert](#) or [en\\_vbat\\_hi\\_alert](#). These alerts are indicated by [vbat\\_lo\\_alert](#) or [vbat\\_hi\\_alert](#) and are cleared by writing them to 0.

### Input Voltage Measurement

Input voltage is measured through a 30:1 resistive voltage divider making the A/D span term for input voltage measurements  $30/18191$  or  $1.649mV/LSB$  and is digitized to [vin](#). An alert may be set on input voltage by setting the value [vin\\_lo\\_alert\\_limit](#) or [vin\\_hi\\_alert\\_limit](#) and setting [en\\_vin\\_lo\\_alert](#) or [en\\_vin\\_hi\\_alert](#). These alerts are indicated by [vin\\_lo\\_alert](#) and [vin\\_hi\\_alert](#) and are cleared by writing them to 0.

**Table 1. Measurement Subsystem LSB Sizes**

MEASUREMENT	UNITS	REGISTER SYMBOL	LSB SIZE	OFFSET
BATTERY VOLTAGE	V	<a href="#">vbat</a>	$192.4\mu V \cdot cell\_count$	
INPUT VOLTAGE	V	<a href="#">vin</a>	1.649mV	
OUTPUT VOLTAGE	V	<a href="#">vout</a>	1.653mV	
INPUT CURRENT	A	<a href="#">iin</a>	$1.466\mu V/RSNSI$	
BATTERY CURRENT	A	<a href="#">ibat</a>	$1.466\mu V/RSNSB$	
DIE TEMPERATURE	°C	<a href="#">die_temp</a>	0.0215°C	264.4°C
BATTERY IMPEDANCE	$\Omega$	<a href="#">bsr</a>	$RSNSB \cdot cell\_count/500$	
THERMISTOR VOLTAGE	V	<a href="#">thermistor_voltage</a>	$45.833\mu V/V$	

## OPERATION

### V<sub>OUT</sub> Voltage Measurement

Output voltage is measured through a 30.07:1 resistive voltage divider making the A/D span term for system voltage measurements 30.07/18191 or 1.653mV/LSB and is digitized to `vout`. An alert may be set on output voltage by setting the value `vout_lo_alert_limit` or `vout_hi_alert_limit` and setting `en_vout_lo_alert` or `en_vout_hi_alert`. These alerts are indicated by `vout_lo_alert` and `vout_hi_alert` and are cleared by writing them to 0.

### Battery Current Measurement

Battery current is measured with a current sense resistor between the CSP and CSN pins. An amplifier with a gain of 37.5 amplifies this signal and refers it to ground internally so that the A/D converter can measure it. The sensed battery current is therefore given by  $I_{BAT} \cdot R_{SNSB} \cdot 37.5$ . For a 10mΩ  $R_{SNSB}$  current sense resistor, the A/D sensitivity is  $1/(18191 \cdot 10m\Omega \cdot 37.5)$  or 146.6μA/LSB. The battery current measurement system has a built in commutator. While charging a battery, two's complement number `ibat` will be positive representing current into the battery. When the battery charger is disabled or terminated, as detected by `charger_suspended`, the commutator is activated and `ibat` will be negative, representing current out of the battery. An alert may be set on the `ibat` measurement by setting the desired value in `ibat_lo_alert_limit` and setting `en_ibat_lo_alert`. While charging, `ibat_lo_alert_limit` can be used to detect when the charge current has dropped below a given threshold. When `charger_suspended`, if set to a negative number, `ibat_lo_alert_limit` can be used to detect if the battery load has exceeded a given threshold. This alert is indicated by `ibat_lo_alert` and is cleared by writing it to 0.

### Input Current Measurement

Input current is measured with a current sense resistor between the CLP and CLN pins. An amplifier with a gain of 37.5 amplifies this signal and refers it to ground internally so that the A/D converter can measure it. The sensed input current is therefore given by  $I_{IN} \cdot R_{SNSI} \cdot 37.5$ . For a 10mΩ  $R_{SNSI}$  current sense resistor, the A/D sensitivity is  $1/(18191 \cdot 10m\Omega \cdot 37.5)$  or 146.6μA/LSB. The input current is digitized to `iin`. An upper limit alert may be set

on input current by setting the value `iin_hi_alert_limit` and setting the `en_iin_hi_alert`. This alert is indicated by `iin_hi_alert` and is cleared by writing it to 0.

### Battery Series Resistance (BSR) Measurement

The LTC4162 can optionally measure the series resistance of the battery stack or cell. If `run_bsr` is set, the LTC4162 momentarily suspends the battery charger and calculates the battery series resistance by dividing the voltage change (charging vs not charging) by the measured charge current (`bsr_charge_current`).

The per-cell resistance value is reported in `bsr` and the charge current observed during the measurement is reported in `bsr_charge_current`. The LTC4162 automatically resets `run_bsr` after the `bsr` measurement is complete. The total battery series resistance value is proportional to the charge current sense resistor,  $R_{SNSB}$ , as well as the `cell_count`, and can be computed in Ω from the expression:

$$R_{BAT}(\Omega) = \frac{bsr \cdot cell\_count \cdot R_{SNSB}}{500}$$

Higher `bsr_charge_current` during a `bsr` measurement results in a more accurate `bsr` measurement. Very low values of `bsr_charge_current` may adversely impact the accuracy of the `bsr` measurement. If charge current is less than C/10 (`bsr_charge_current < icharge_over_10`), `bsr_questionable` will be set indicating that `bsr_charge_current` during the `bsr` test was less than optimum for an accurate reading. Recall that full charge current typically flows at the beginning of a charge cycle (presuming the battery is more deeply depleted) and will diminish when the charger enters the constant voltage phase of charging.

If `run_bsr` is set to 1 and the battery charger is not currently running, then the LTC4162 will be queued to perform the `bsr` measurement only after the start of the next charge cycle. An alert can be set with `en_bsr_done_alert` to generate a `bsr_done_alert` interrupt indicating that a `bsr` measurement is complete and that the result is available. A `bsr_hi_alert` may also be set on battery series impedance by writing a `bsr_hi_alert_limit` and setting `en_bsr_hi_alert`. Again, the `bsr` reading is the per-cell battery resistance and should be scaled by `cell_count` or, consequently, the

## OPERATION

target total resistance threshold for `bsr_hi_alert_limit` should be divided by `cell_count` before being written to `bsr_hi_alert_limit`.

`bsr_done_alert` and `bsr_hi_alert` are cleared by writing them to 0.

### Die Temperature Measurement

The LTC4162 has an integrated die temperature sensor that is monitored by the A/D converter and is digitized to `die_temp`. The die temperature is derived from an internal circuit and follows the equation:

$$T_{DIE}(\text{°C}) = \text{die\_temp} \cdot 0.0215\text{°C/LSB} - 264.4\text{°C}$$

An alert may be set on die temperature by setting the value `die_temp_hi_alert_limit` and setting `en_die_temp_hi_alert`. This alert is indicated by `die_temp_hi_alert` and is cleared by writing it to 0.

To set the `die_temp_hi_alert_limit`, compute the threshold value from:

$$\text{die\_temp\_hi\_alert\_limit} = \frac{T_{DIE}(\text{°C}) + 264.4\text{°C}}{0.0215\text{°C/LSB}}$$

### Battery Temperature (NTC Thermistor) Measurement

To measure the battery temperature using a thermistor, connect the thermistor,  $R_{NTC}$ , normally being located in the battery pack, between the NTC pin and ground, and a low drift bias resistor,  $R_{NTCBIAS}$ , between NTCBIAS and NTC.  $R_{NTCBIAS}$  should be a 1% or better resistor with a value equal to the value of the chosen thermistor at 25°C ( $R_{25}$ ). The LTC4162 applies an excitation voltage of 1.2V to  $R_{NTCBIAS}$  to measure the thermistor value. The thermistor measurement result is available at `thermistor_voltage`. To minimize battery stress due to charging at temperature extremes, the LTC4162 has both a simple and a more advanced JEITA (Japan Electronics and Information Technology Industries Association) temperature qualified charging algorithm. If the application does not require temperature controlled charging, then the thermistor should be replaced with a resistor of equal value to the bias resistor  $R_{NTCBIAS}$  to continuously simulate 25°C. If the thermistor is found to be open (`thermistor_voltage` > `open_thermistor`)

either during the battery detection test or during charging, `charger_state` will switch to `bat_missing_fault` and charging will halt. Either a `thermistor_voltage_lo_alert` or `thermistor_voltage_hi_alert` may be set with `en_thermistor_voltage_lo_alert` or `en_thermistor_voltage_hi_alert`, both of which are cleared by writing them to 0.

The temperature vs resistance curve of a thermistor can be obtained from thermistor manufacturers in either table form or estimated by applying the modified Steinhart-Hart equation:

$$R_{NTC} = R_{25} \cdot e^{\left( A + \frac{B}{T_C + 273.15} + \frac{C}{(T_C + 273.15)^2} + \frac{D}{(T_C + 273.15)^3} \right)}$$

Where  $R_{25}$  is the thermistor's resistance at 25°C and A, B, C and D are provided by the thermistor manufacturer and  $T_C$  is the temperature in °C.

The temperature of the thermistor is computed from its resistance value by the complementary Steinhart-Hart expression where  $A_1$ ,  $B_1$ ,  $C_1$  and  $D_1$  are also provided by the thermistor manufacturer.

$$T_C = \frac{1}{A_1 + B_1 \ln\left(\frac{R_{NTC}}{R_{25}}\right) + C_1 \ln^2\left(\frac{R_{NTC}}{R_{25}}\right) + D_1 \ln^3\left(\frac{R_{NTC}}{R_{25}}\right)} - 273.15\text{°C} \quad (1)$$

Alternatively, the more common but less accurate condensed version of Steinhart-Hart using the ubiquitous  $\beta$  parameter may be employed:

$$R_{NTC} = R_{25} \cdot e^{-\beta_{25/85} \left( \frac{1}{298.15\text{°C}} - \frac{1}{T_C + 273.15\text{°C}} \right)}$$

Where again,  $R_{25}$  is the thermistor's resistance at 25°C and several  $\beta$  values are provided by the thermistor manufacturer, one for each of a number of temperature ranges.

The inverse  $\beta$  form is:

$$T_C = \frac{\beta_{25/85}}{\ln\left(\frac{R_{NTC}}{R_{25}}\right) + \frac{\beta_{25/85}}{298.15\text{°C}}} - 273.15\text{°C} \quad (2)$$



## OPERATION

The LTC4162 thermistor measurement system is designed specifically for a thermistor with a  $\beta_{25/85}$  value of 3490K and returns `thermistor_voltage` where:

$$\text{thermistor\_voltage} = 18191 \cdot 1.2 \cdot \frac{R_{\text{NTC}}}{R_{\text{NTC}} + R_{\text{NTCBIAS}}}$$

where typically  $R_{\text{NTCBIAS}}$  is set equal to  $R_{25}$ , the 25°C value of the thermistor. To arrive at the thermistor's temperature in °C from `thermistor_voltage` substitute  $R_{\text{NTC}}$  from:

$$R_{\text{NTC}} = R_{\text{NTCBIAS}} \cdot \frac{\text{thermistor\_voltage}}{18191 \cdot 1.2 - \text{thermistor\_voltage}}$$

into Equation 1 or Equation 2.

For thermistors with a  $\beta_{25/85}$  value higher than 3490K see Alternate Thermistors and Biasing in the Applications section.

### Output Current Measurement

There is no sense resistor dedicated to measuring output current but its value can be obtained nonetheless. Output current is delivered from the input supply if `vin_gt_vbat` is true and from the battery if it is false.

If `vin_gt_vbat` is true and the battery charger is enabled (`en_chg` is true) then the input current measurement will be the sum of current to the switching charger and the output load. In this instance the switching charger will need to be disabled with `suspend_charger` to obtain an output current reading. It's also possible that the charger may already be terminated. If `en_chg` is false then set `telemetry_speed` to `tel_high_speed`, wait 20ms or more, and record `iin` as output current. If `en_chg` is true then set both `suspend_charger` and `force_telemetry_on` to 1 and `telemetry_speed` to `tel_high_speed`, wait 20ms or more for at least one telemetry cycle, and again record `iin` as output current. `suspend_charger` should then be cleared. Note that suspending the charger resets the `tchargetimer` and `tcvtimer` termination timers to 0.

On the other hand if `vin_gt_vbat` is false then the output current will be delivered from the battery and its value can be obtained from `-ibat`. Since `vin_gt_vbat` is low, the telemetry system will be disabled and the `ibat` reading will be stale.

To enable the telemetry system, set `force_telemetry_on` to 1 and `telemetry_speed` to `tel_high_speed`. `telemetry_valid` indicates when fresh telemetry readings are available. To avoid polling for `telemetry_valid` a `telemetry_valid_alert` can be set with `en_telemetry_valid_alert`. Once the reading is obtained, `force_telemetry_on` can be cleared or `telemetry_speed` set to `tel_low_speed` for power savings.

### Low Power Telemetry

If input power is available (`vin_gt_vbat` = 1), and the battery is being charged, the telemetry system will be in its high speed mode returning results at a rate of roughly once per 11ms. If, on the other hand, charging has terminated normally or paused due to battery temperature out of range, the telemetry system will drop back to a rate of about once every 5 seconds to save power. When input power is not available (`vin_gt_vbat` = 0) it is still possible to collect telemetry data by setting `force_telemetry_on`. To save power in this mode the telemetry system will default to the lower speed 5 second mode. To force the higher telemetry rate, and suffer the higher quiescent current of roughly 2.5mA, the `telemetry_speed` can be set to the higher ~11ms rate by setting it to `tel_high_speed`.

### Configurable Limit Alert Subsystem

The I<sup>2</sup>C port also supports the SMBus `SMBALERT` protocol, including the Alert Response Address. An alert can optionally be generated if a monitored parameter exceeds a programmed limit or if a selected battery `charger_state` or any of a wide number of other `charge_status` change or fault events occur. This off-loads much of the continuous monitoring from the system's microcontroller and onto the LTC4162; reducing bus traffic and microprocessor load.

The `SMBALERT` pin is asserted (pulled low) whenever an enabled alert occurs. After asserting an interrupt, the LTC4162 responds to the host's Alert Response Address (ARA = 0b0001100[1]) with its own read address. If another part with a pending alert and a lower address also responds, that part wins the arbitration and the LTC4162 will stop responding to this ARA, keeping its `SMBALERT` pin asserted. Only a response of the LTC4162's complete read address will clear the LTC4162's `SMBALERT` signal.

## OPERATION

**Table 2. Summary of Limit Alerts Registers**

ALERT VALUE SETTING (0x01 – 0x0C)	EN_LIMIT_ALERTS_REG	LIMIT_ALERTS_REG
vin_hi_alert_limit	en_vin_hi_alert	vin_hi_alert
vin_lo_alert_limit	en_vin_lo_alert	vin_lo_alert
thermistor_voltage_hi_alert_limit	en_thermistor_voltage_hi_alert	thermistor_voltage_hi_alert
thermistor_voltage_lo_alert_limit	en_thermistor_voltage_lo_alert	thermistor_voltage_lo_alert
bsr_hi_alert_limit	en_bsr_hi_alert	bsr_hi_alert
die_temp_hi_alert_limit	en_die_temp_hi_alert	die_temp_hi_alert
ibat_lo_alert_limit	en_ibat_lo_alert	ibat_lo_alert
iin_hi_alert_limit	en_iin_hi_alert	iin_hi_alert
vout_hi_alert_limit	en_vout_hi_alert	vout_hi_alert
vout_lo_alert_limit	en_vout_lo_alert	vout_lo_alert
vbat_hi_alert_limit	en_vbat_hi_alert	vbat_hi_alert
vbat_lo_alert_limit	en_vbat_lo_alert	vbat_lo_alert
NA	en_bsr_done_alert	bsr_done_alert
NA	en_telemetry_valid_alert	telemetry_valid_alert

**Table 3. Summary of Charger State Alerts**

CHARGER_STATE_REG	EN_CHARGER_STATE_ALERTS_REG	CHARGER_STATE_ALERTS_REG
bat_detect_failed_fault	en_bat_detect_failed_fault_alert	bat_detect_failed_fault_alert
battery_detection	en_battery_detection_alert	battery_detection_alert
charger_suspended	en_charger_suspended_alert	charger_suspended_alert
cc_cv_charge	en_cc_cv_charge_alert	cc_cv_charge_alert
ntc_pause	en_ntc_pause_alert	ntc_pause_alert
timer_term	en_timer_term_alert	timer_term_alert
c_over_x_term	en_c_over_x_term_alert	c_over_x_term_alert
max_charge_time_fault	en_max_charge_time_alert	max_charge_time_fault_alert
bat_missing_fault	en_bat_missing_fault_alert	bat_missing_fault_alert
bat_short_fault	en_bat_short_fault_alert	bat_short_fault_alert

**Table 4. Summary of Charger Status Alerts**

CHARGE_STATUS_REG	EN_CHARGE_STATUS_ALERTS_REG	CHARGE_STATUS_ALERTS_REG
constant_voltage	en_constant_voltage_alert	constant_voltage_alert
constant_current	en_constant_current_alert	constant_current_alert
iin_limit_active	en_iin_limit_active_alert	iin_limit_active_alert
vin_uvcl_active	en_vin_uvcl_active_alert	vin_uvcl_active_alert
thermal_reg_active	en_thermal_reg_active_alert	thermal_reg_active_alert
ilim_reg_active	en_ilim_reg_active_alert	ilim_reg_active_alert

## OPERATION

This allows the system to have many parts share a common interrupt line. If multiple parts are asserting the `SMBALERT` signal then multiple reads from the ARA are needed. For more information refer to the SMBus specification.

After the ARA process is complete, alert bits can be cleared by individually writing them to 0 and writing the remaining bits in the register to 1. This preserves any other pending alert bits as writing 1s to the alert registers are ignored.

### Series Cell Count Selection

Cell count selection of up to eight series cells is made via the `CELLS1` and `CELLS0` pins. `CELLS1` and `CELLS0` should be pin strapped to either GND, `VCC2P5`, or `INTVCC` to make the `cell_count` selection (see Table 5). For added safety, `cell_count` can be read back from the I<sup>2</sup>C port. The GND/GND combination will result in a `cell_count_err` and will inhibit charging. Note that the number of cells multiplied by their expected maximum cell voltage during charging cannot exceed  $V_{IN} - V_{IN\_DUVLO}$ .

**Table 5. CELLS0 and CELLS1 Pin Mapping to Series Cell Count**

CELLS1	CELLS0	cell_count
INTV <sub>CC</sub>	INTV <sub>CC</sub>	1
INTV <sub>CC</sub>	VCC2P5	2
INTV <sub>CC</sub>	GND	3
VCC2P5	INTV <sub>CC</sub>	4
VCC2P5	VCC2P5	5
VCC2P5	GND	6
GND	INTV <sub>CC</sub>	7
GND	VCC2P5	8
GND	GND	9

When charging stacks of two or more cells in series it is important to consult with the battery manufacturer to ascertain requirements pertaining to cell balancing. Repeatedly charging series stacks of cells without balancing is usually degenerative and typically leads to increased mismatch accompanied with shorter battery life. For high reliability applications an auxiliary battery balancer is recommended.

### Battery Detection

The LTC4162 begins a charging cycle by performing a 2-4 second battery detection test, during which a 1mA load is drawn from the battery followed by a small charge current being sent to the battery. If the battery voltage remains stable during the battery detection test, the LTC4162 proceeds with battery charger soft-start. If the battery voltage does not remain stable, the LTC4162 proceeds with a battery open/short test. The battery is charged at minimum charge current for one to two seconds. Abnormal results from the battery detection test result in `charger_state` becoming `bat_missing_fault`, `bat_short_fault` or `bat_detect_failed_fault` and will prevent further charging. A `charger_state` of `bat_missing_fault` will also occur if the thermistor is open or has a very high value (`thermistor_voltage` > `open_thermistor`). Programmable interrupts `en_bat_short_fault_alert`, `en_bat_missing_fault_alert` and `en_bat_detect_failed_fault_alert` can be set to generate an `SMBALERT` if one of these cases occurs. In the event of a battery detection fault, the battery detection test will retry every 30 seconds.

### Battery Charger Soft-Start

The LTC4162 soft starts charge current by ramping `icharge_dac` from 0 to its target charge current setting at a nominal rate of 400 $\mu$ S per `icharge_dac` LSB. This results in a maximum charge current soft start time of  $31 \cdot 400\mu\text{s}$  or 12.4ms. Any time the battery charger needs to change its charge current setting up or down, the ramp routine is invoked. The charge current target is derived from either `charge_current_setting` or the JEITA temperature qualified charging system, `icharge_jeita_2` through `icharge_jeita_6` (See Advanced JEITA Temperature Controlled Charging).

### Low Battery

If the `BATSENS+` pin voltage is lower than about 2.5V, the battery charger delivers roughly 10mA directly from `INTVCC`. This operating mode is mainly used to pull a pack protected battery out of protection mode. When the `BATSENS+` pin voltage reaches 2.5V, charging hands over to the switching battery charger and proceeds to the full constant-current/constant-voltage charging phase reporting `cc_cv_charge`.

## OPERATION

### Constant-Current Charging

The charger will attempt to deliver either  $(\text{icharge\_jeita\_x} + 1) \cdot 1\text{mV}/R_{\text{SNSB}}$  with `en_jeita` or  $(\text{charge\_current\_setting} + 1) \cdot 1\text{mV}/R_{\text{SNSB}}$  without `en_jeita` in constant-current mode where `icharge_jeita_x` or `charge_current_setting` ranges from 0 to 31. For example, A 10mΩ resistor between CPS and CSN would give an upper limit charge current of 3.2A. Depending on available input power and external load conditions, the battery charger may not be able to charge at the full programmed rate. An alternate control loop such as the input current limit loop or input voltage limit loop may be in force and only partial power will be available to charge the battery. If input current limit is reached, for instance, the system load will be prioritized over the battery charge current. When system loads are light, battery charge current will be maximized and could be as high as the value programmed by `icharge_jeita_x` or `charge_current_setting`.

The charge current programming resistor,  $R_{\text{SNSB}}$ , should always be set to match the capacity of the battery without regard to source or load limitations from any other control loop. The multiple control-loop architecture of the LTC4162 will correct for any discrepancies, always optimizing transfer of power to the battery and the load.

### Thermal Regulation

When the switching battery charger is enabled at an elevated ambient temperature, LTC4162 self heating may push its junction temperature to an unacceptable level. To prevent overheating the LTC4162 monitors its own `die_temp` and automatically reduces the `icharge_dac` to limit power dissipation. The differential servo voltage at CSP to CSN can drop to as low as 1mV giving about 3% (1/32) of the maximum charge current. The thermal regulation algorithm achieves this by enforcing a maximum `icharge_dac` setting which drops linearly from 31 to 0 as `die_temp` increases from `thermal_reg_start_temp` (default 120°C) to `thermal_reg_end_temp` (default 125°C). When the thermal regulation algorithm is active, `charge_status` becomes `thermal_reg_active`. A `thermal_reg_active_alert` can be set with `en_thermal_reg_active_alert` and cleared by writing either back to 0. Thermal regulation can be programmed to any temperature within the LTC4162's operating range.

### Constant-Voltage Charging

Once the BATSENS+ voltage reaches the programmed charging voltage the switching regulator will reduce its output power and hold the battery voltage steady at either  $(3.4125\text{V} + 12.5\text{mV} \cdot \text{vcharge\_jeita\_x}) \cdot \text{cell\_count}$  with `en_jeita` or  $(3.4125\text{V} + 12.5\text{mV} \cdot \text{vcharge\_setting}) \cdot \text{cell\_count}$  without `en_jeita` where `vcharge_jeita_x` and `vcharge_setting` each range from 0 to 31. In constant voltage mode the charge current will decrease naturally toward zero providing inherently safe operation by preventing the battery from being over charged. Multiple charge voltage settings are available for final top-off voltage selection via `vcharge_jeita_x` with `en_jeita` or `vcharge_setting` without `en_jeita`. While charge voltage trade-offs can be made to preserve battery life or maximize capacity, it is not possible for the LTC4162 to be set to a charge voltage that is dangerously high or inconsistent with a Lithium-Ion/Polymer Battery.

Note that `charge_current_setting` and `vcharge_setting` do not directly control the `icharge_dac` and `vcharge_dac`. They are only target values. For example, if the JEITA Temperature Controlled Charging system is enabled (`en_jeita = 1`), the DACs will be controlled by this user programmable system (i.e. `icharge_jeita_2` through `icharge_jeita_6`, `vcharge_jeita_2` through `vcharge_jeita_6`).

### Basic Temperature Controlled Charging

The LTC4162 provides temperature controlled charging if a grounded thermistor and a bias resistor are connected to the NTCBIAS and NTC pins and `en_jeita` is set to 0. Charging is paused if `thermistor_voltage` rises above `jeita_t1` (0°C) or falls below `jeita_t6` (60°C). Recall that thermistors have a negative temperature coefficient so higher temperatures will read lower `thermistor_voltage` and vice versa. If charging is not suspended, the charging voltage and current will follow `vcharge_setting` and `charge_current_setting` respectively.

The default upper and lower limits are based on a thermistor with a  $\beta_{25/85}$  value of 3490K, such as provided by a Vishay NTCS0402E3103FLT. This thermistor was chosen specifically because of its weak temperature characteristic relative to other thermistors. Stronger thermistors can



## OPERATION

be diluted to match it by placing a low drift resistor in series with the thermistor and increasing the bias resistor accordingly. (see [Alternate Thermistors and Biasing](#) in Applications Information for details). If the application does not require temperature controlled charging then the thermistor should be replaced with a resistor of equal value to bias resistor  $R_{NTCBIAS}$ , for example, 100k $\Omega$ .

### Advanced JEITA Temperature Controlled Charging

A control system is included to provide compliance with the Japan Electronics and Information Technology Industries Association guidelines on battery charging by leaving `en_jeita` set to its default value of 1. Specifically, a very flexible multi-point temperature-voltage-current profile can be programmed into the LTC4162 to ensure that charging parameters as a function of temperature are used. Figure 1 and Table 6 illustrate default values of the JEITA system available in the LTC4162. There are seven distinct temperature regions programmed by the six `thermistor_voltage` based temperature set points `jeita_t1`

through `jeita_t6`. For each of the temperature regions, the charge current and charge voltage can be programmed within the limits set by  $(V_{CSP} - V_{CSN})/R_{SNSB}$  (`charge_current_setting`) and battery charge voltage (`vcharge_setting`). When `en_jeita` is true, The JEITA system writes its registers, `icharge_jeita_2` through `icharge_jeita_6` and `vcharge_jeita_2` through `vcharge_jeita_6` to `charge_current_setting` and `vcharge_setting` which are then passed on to the `icharge_dac` and `vcharge_dac`.

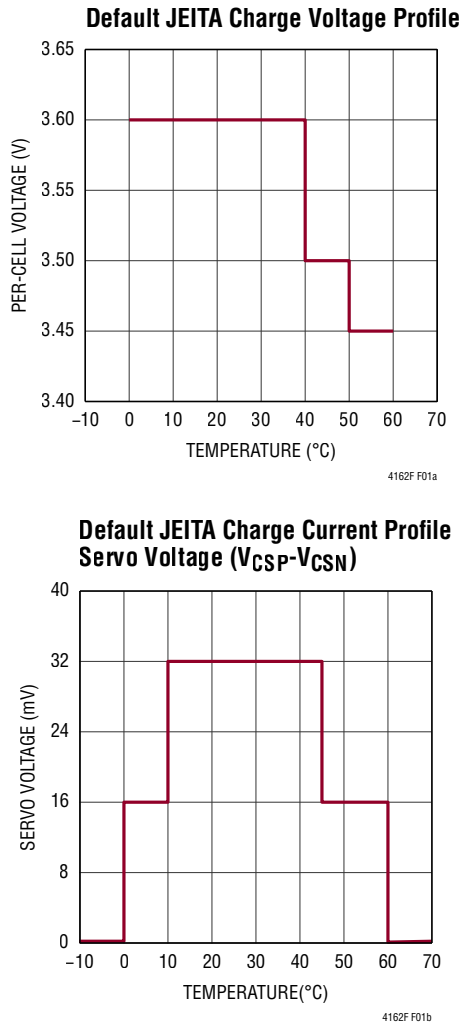
*Writing values to `charge_current_setting` and `vcharge_setting` with `en_jeita` set is futile as the JEITA system will overwrite these values every 11ms.*

The values for the JEITA registers are shown below. The bold values in the tables are programmable. The `jeita_t1` through `jeita_t6` registers determine the `thermistor_voltage` values for the breakpoints between regions. Table 6 lists the default values of the JEITA charging parameters along with example values of a 10k $\Omega$  thermistor with a  $\beta$  value of 3490K. All of the temperature, voltage and current settings can be modified for maximum flexibility.

**Table 6. Tabular Representation of the JEITA system, Default JEITA Values and  $\beta = 3490K$  Equivalent Temperatures**

<code>jeita_region</code>	<code>vcharge_jeita</code>	Charge Voltage	<code>icharge_jeita</code>	Charge Current	JEITA Temperature	<code>thermistor_voltage</code>	RNTC	Temp
R1	Charger Off							
					<code>jeita_t1</code>	<b>16117</b>	28215 $\Omega$	0°C
R2	<b>15</b>	3.60V	<b>15</b>	16mV/ $R_{SNSB}$				
					<code>jeita_t2</code>	<b>14113</b>	18290 $\Omega$	10°C
R3	<b>15</b>	3.60V	<b>31</b>	32mV/ $R_{SNSB}$				
					<code>jeita_t3</code>	<b>7970</b>	5751 $\Omega$	40°C
R4	<b>7</b>	3.50V	<b>31</b>	32mV/ $R_{SNSB}$				
					<code>jeita_t4</code>	<b>7112</b>	4832 $\Omega$	45°C
R5	<b>7</b>	3.50V	<b>15</b>	16mV/ $R_{SNSB}$				
					<code>jeita_t5</code>	<b>6325</b>	4080 $\Omega$	50°C
R6	<b>3</b>	3.45V	<b>15</b>	16mV/ $R_{SNSB}$				
					<code>jeita_t6</code>	<b>4970</b>	2948 $\Omega$	60°C
R7	Charger Off							

## OPERATION



**Figure 1. Default JEITA Temperature Profile Gives A Graphical Representation of the Seven JEITA Regions, the Six Breakpoint and the Default Values**

### Battery Charger Termination and Full Charge Indication (C/x)

The LTC4162 supports several battery charge termination methods.

If enabled, a maximum elapsed charge time timer is started at the beginning of each charge cycle and, upon achieving [constant\\_voltage](#) regulation, a constant-voltage timer may also be started. At the expiration of either of these timers, charging of the battery will discontinue and no more current will be delivered. The elapsed time timer expires

when [tcharge\\_timer](#) reaches [max\\_charge\\_time](#) and the constant-voltage timer expires in [constant\\_voltage](#) when [tcvtimer](#) reaches [max\\_cv\\_time](#). Default [max\\_cv\\_time](#) is 3600 seconds (1 hour). To set different timer expiration values, [max\\_charge\\_time](#) and [max\\_cv\\_time](#) are both adjustable. The resolution of [max\\_cv\\_time](#) is 1 second/LSB and for [max\\_charge\\_time](#) it is 1 minute/LSB.

[tcvtimer](#) can be read back to determine the cumulative time in [constant\\_voltage](#) regulation. [max\\_cv\\_time](#) is a 16 bit unsigned value ranging from 0 to 65535 seconds (~18 hours). [tcharge\\_timer](#), the total charge time safety timer, can be read back at any time to determine the elapsed time since the beginning of this charge cycle. [max\\_charge\\_time](#) is a 16 bit unsigned value at 1 minute per LSB ranging from 0 to 65535 minutes (~45 days). The [tcharge\\_timer](#) is disabled when [max\\_charge\\_time](#) is left at its default value of 0. To enable the [tcharge\\_timer](#) write a non 0 value to [max\\_charge\\_time](#).

[max\\_charge\\_time\\_fault](#) indicates that charging has terminated due to [tcharge\\_timer](#) reaching [max\\_charge\\_time](#) and [timer\\_term](#) indicates that charging has terminated due to [tcvtimer](#) reaching [max\\_cv\\_time](#). The [max\\_charge\\_time\\_fault](#) will persist until either the battery voltage drops to less than 35% of its target voltage setting, whereupon a new charge cycle begins and the [tcharge\\_timer](#) resets, or a power cycle occurs resetting the entire charger state machine. A normal termination such as [timer\\_term](#) or [c\\_over\\_x\\_term](#) also resets [tcharge\\_timer](#). Finally, the [max\\_charge\\_time\\_fault](#) is cleared upon abnormal conditions such as the input voltage falling below the BATSNS+ pin voltage, [suspend\\_charger](#) or if any another system fault occurs: not [intvcc\\_gt\\_2p8v](#), not [vin\\_gt\\_4p2v](#), not [vin\\_gt\\_vbat](#), [thermal\\_shutdown](#), [no\\_rt](#) or [cell\\_count\\_err](#).

Alternately, if [en\\_c\\_over\\_x\\_term](#) is set, the LTC4162 will also terminate charging once [constant\\_voltage](#) is reached and [ibat](#) has naturally dropped to the [c\\_over\\_x\\_threshold](#). The default [c\\_over\\_x\\_threshold](#) value of [c\\_over\\_10](#) is a good indication that the battery has reached a nearly full state of charge. The [c\\_over\\_x\\_threshold](#) is adjustable via the I<sup>2</sup>C port. If [en\\_c\\_over\\_x\\_term](#) is set, charging will terminate at the first of either [c\\_over\\_x\\_term](#), [timer\\_term](#) or [max\\_charge\\_time\\_fault](#). The [constant\\_voltage](#) timer ter-

## OPERATION

mination features can be disabled by setting `max_cv_time` to 0. Both of the charge timers will be paused in `ntc_pause`.

The LTC4162 can optionally be configured to generate an interrupt at C/x termination by setting `en_c_over_x_term_alert`. Timer termination alerts can also be set with either `en_timer_term_alert` for the `constant_voltage` timer or `en_max_charge_time_alert` for `max_charge_time_fault`.

`c_over_x_term`, `timer_term` and `max_charge_time_fault` determine what caused the `SMBALERT`. The LTC4162 terminates charging by disabling the switching charger which makes the SW node high impedance.

## Automatic Recharge

After a normal termination, the charger will remain off. If the portable product remains in this state long enough, the battery will eventually self discharge. To ensure that the battery is always topped off, a new charge cycle will automatically begin when the battery voltage falls below approximately 3.35V per `cell_count` and can be changed by writing a new value to `v_recharge_lifepo4`. The termination safety timers, `tcvtimer` and `tchargetimer`, will reset back to zero. A new charge cycle will also be initiated if input power is cycled or if the charger is momentarily disabled (e.g. `suspend_charger` set to 1, then back to 0).

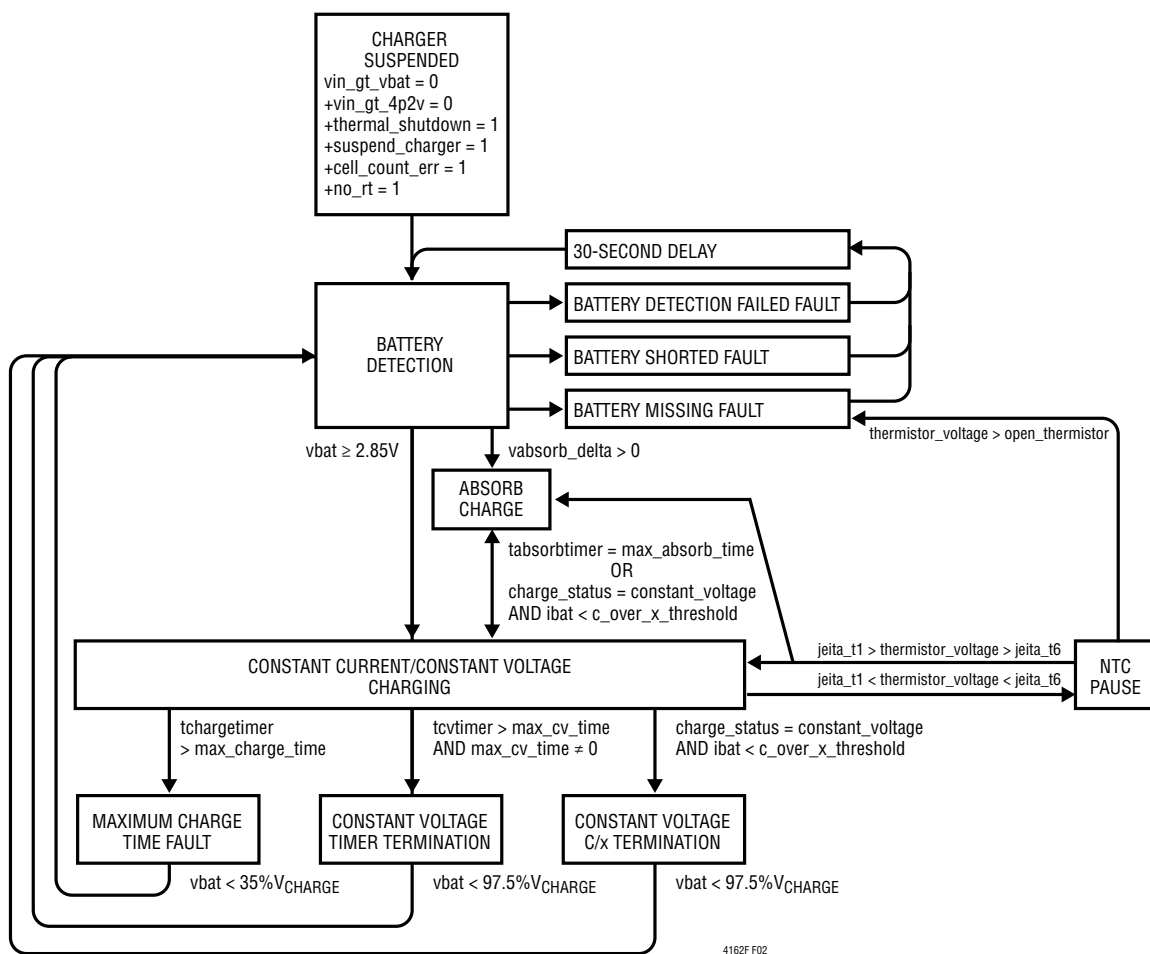


Figure 2. Battery Charging State Diagram

## OPERATION

### Absorb (Rapid) Charging

The LTC4162 can optionally perform an accelerated absorb, or rapid, charge phase if `vabsorb_delta` is greater than zero. During the absorb phase the battery terminal voltage is allowed to rise `vabsorb_delta` above the normal `constant_voltage` level for up to a default `max_absorb_time` of 900 seconds or 15 minutes. Note that depending on battery state of charge, charge current and series resistance the battery terminal voltage may not necessarily reach the increased absorb voltage during the `tabsovertime` period. The `vabsorb_delta` default of 0 inhibits the rapid charging phase.

### Low Power Ship Mode

The LTC4162 can reduce its already low battery-only standby current to about 2.8 $\mu$ A in a special mode designed for shipment and storage. Ship mode is armed by setting `arm_ship_mode` to `arm`. It does not take effect, however, until the input voltage  $V_{IN}$  drops below approximately 1V. Upon return of the input voltage above approximately 1V the LTC4162 wakes from ship mode. The decision to remain out of ship mode is latched once the internal voltage reference is re-biased and  $V_{IN}$  is detected as having reached about 4.2V (`vin_gt_4p2v`). In ship mode, the VCC2P5 2.5V logic LDO and the INTV<sub>CC</sub> 5V system LDO are deactivated and, along with them, all logic and communications with the I<sup>2</sup>C port. Consequently, no settings or state information will persist through a ship mode cycle.

### Oscillator Synchronization

The SYNC pin is available to synchronize the switching battery charger to an external clock for optimum noise immunity. To use the SYNC pin, use the  $R_T$  pin to set the frequency of the internal oscillator to the frequency expected by the SYNC signal. If no signal is present at SYNC, the internal oscillator will run normally. If a signal within the required tolerance range appears at SYNC, the internal oscillator will detect it and synchronize with it. To avoid a long or short cycle, synchronization won't occur until the internal oscillator and external signals coincide.

Therefore, synchronization may take several thousand cycles (milliseconds) to occur. If SYNC is not used, it should just be grounded.

### Under Voltage Lockout Circuits/`suspend_charger`/ System Faults

Various supply monitor circuits, as well as `suspend_charger`, can disable charging. If the voltage at  $V_{IN}$  falls below BATSENS+ (i.e. not `vin_gt_vbat`), or `thermal_shutdown` (die temperature above  $\sim 150^{\circ}\text{C}$ ), `no_rt` resistor, not `intvcc_gt_2p8v`, not `vin_gt_4p2v`, or a CELLS0/1 pins `cell_count_err`, the LTC4162 suspends charging and reports `charger_suspended`. In the absence of any of the above fault conditions, charging is re-enabled when  $V_{IN}$  rises  $V_{IN\_DUVLO}$  above the BATSENS+ voltage.

### LTC4162 Lithium Iron Phosphate Variants

The LTC4162-FAD is fully programmable and follows the descriptions given thus far but there are two other variants available as well. Each of these three versions is available with and without solar panel maximum power tracking enabled by default.

The other LTC4162 lithium iron phosphate variants are:

LTC4162-FST

LTC4162-FFS

The LTC4162-FST is identical to the LTC4162-FAD but, for improved safety, the JEITA values as well as `v_recharge_lifepo4`, `vabsorb_delta` and `max_absorb_time` are not writable.

The LTC4162-FFS variant enables the `absorb_charge` (rapid) feature by having a default `vabsorb_delta` of 16 representing 200mV/`cell_count` above the normal charging voltage. In the LTC4162-FFS variant the JEITA values, `v_recharge_lifepo4`, `vabsorb_delta` and `max_absorb_time` are also not writable.

## APPLICATIONS INFORMATION

### SMBus and I<sup>2</sup>C Protocol Compatibility

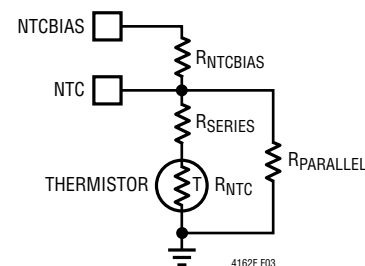
The LTC4162 uses an SMBus/I<sup>2</sup>C style 2-wire serial port for some programming and all monitoring functions. Over the serial port the user may program alert values which are compared against measured parameters, set control parameters and read status data. The [Timing Diagram](#) shows the relationship of the signals on the bus. The two bus lines, SDA and SCL, must be high when the bus is not in use. External pull-up resistors are required on these lines. The LTC4162 is both a slave receiver and slave transmitter. It is never a master. The control signals, SDA and SCL, are scaled internally to the DV<sub>CC</sub> supply for compliance with the I<sup>2</sup>C specification. DV<sub>CC</sub> should be connected to the same power supply as the bus pull-up resistors.

Aside from electrical levels and bus speed, the SMBus specification is generally compatible with the I<sup>2</sup>C specification, but extends beyond I<sup>2</sup>C to define and standardize specific formats for various types of transactions. The LTC4162 serial port is compatible with the 0Hz-400kHz speed and ratiometric input thresholds of the I<sup>2</sup>C specification, but supports both the Read-Word and Write-Word protocols of the SMBus specification, either with or without packet error checking (PEC). The SMBALERT and ARA protocols of the SMBus specification are also supported. Finally, it has built-in timing delays and glitch suppression filters to ensure correct operation with both protocols.

The input logic levels of I<sup>2</sup>C and SMBus are specified differently. I<sup>2</sup>C specifies logic levels that are ratiometric to supply and SMBus specifies absolute levels. By comparing the specifications, it can be shown that the logic levels are compatible for supply voltages ranging from 2.667V to 3.000V, however, with a well designed system, I<sup>2</sup>C compatible and SMBus compatible parts are often found to be interchangeable. Appendix B of System Management Bus (SMBus) Specification Version 2.0 highlights differences between SMBus and I<sup>2</sup>C, as does section 4 of I<sup>2</sup>C-bus Specification and User Manual.

### Alternate Thermistors and Biasing

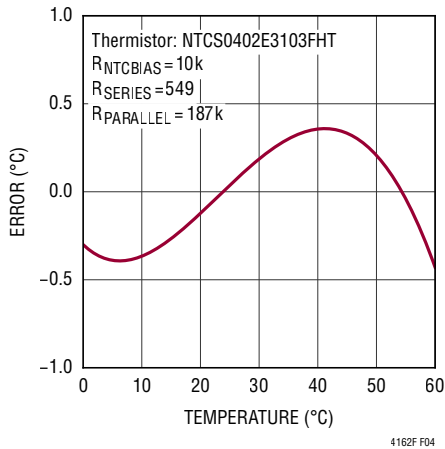
Thermistors with a  $\beta$  value higher than 3490K may be used with the LTC4162 by either diluting the thermistor with an inexpensive low drift series resistor, R<sub>SERIES</sub>, or overwriting [jeita\\_t1](#) through [jeita\\_t6](#) with appropriate values. If a single dilution resistor is added, R<sub>NTCBIAS</sub> should be increased by an amount equal to the dilution resistor to pad the bias resistor, thereby returning the resistor ratio to 50% and, therefore, yielding no error at 25°C. Slightly more padding of R<sub>NTCBIAS</sub> may be desired to lift and center the error curve over a given temperature range. With the addition of one more resistor, R<sub>PARALLEL</sub>, to the thermistor bias network, it's possible to further refine the temperature profile of a higher  $\beta$  thermistor to match the expected  $\beta$  value of 3490K. The values of R<sub>NTCBIAS</sub>, R<sub>PARALLEL</sub> and R<sub>SERIES</sub> can be selected to nearly match the thermistor profile expected by the LTC4162. An example is included here as a demonstration.



**Figure 3. Diluting the Thermistor with Low Drift Series and Parallel Resistors**

For a 10k Vishay NTC50402E3103FHT thermistor which has a  $\beta_{25/75}$  value of 3950K, using R<sub>NTCBIAS</sub> = 10k, R<sub>SERIES</sub> = 549 and R<sub>PARALLEL</sub> = 187k will closely mimic the profile of a thermistor  $\beta$  value of 3490K over the 0°C to 60°C range resulting in a nominal error of under  $\pm 0.5^\circ\text{C}$  for the default JEITA temperature thresholds defined by [jeita\\_t1](#) through [jeita\\_t6](#). This error is significantly less than the error tolerance of most thermistors.

## APPLICATIONS INFORMATION



**Figure 4. Residual Error from 0°C to 60°C for a  $\beta_{25/75} = 3950K$  Thermistor**

For tools that can assist with alternate thermistors, please visit the [LTC4162](#) web page.

### Programming the Input and Battery Charge Current Limits

The LTC4162 features independent resistor programmability of the input current and battery charge current upper limits to facilitate optimal charging from a wide variety of input power sources. The battery charge current should be programmed solely on the basis of the size of the battery and its associated safe charging rate. Typically, this rate is about "1C", or equal to the current which would discharge the battery in one hour. For example, a 2000mAh battery would be charged with no more than 2A. With the full scale (default) charge current programmed via the resistor,  $R_{SNSB}$ , between CSP and CSN, all other selectable charge current settings are lower and may be appropriate for custom charge algorithms at extreme temperatures. If the battery charge current limit requires more power than is available from the selected input current limit, the input current limit will be enforced and the battery will be charged with less than the programmed current. Thus, the battery charger sense resistor should be programmed

based on the battery capacity only, without concern for the input source.

The maximum average input current is determined by the sense resistor,  $R_{SNSI}$ , connected between the CLP and CLN pins. Its value should be chosen based only on the maximum available current limit of the expected input source. The input and charge current loops servo the voltages across their respective sense resistors to a maximum of 32mV, giving maximum input and charge currents of:

$$I_{IN(MAX)} = 32mV/R_{SNSI}$$

$$I_{CHG(MAX)} = 32mV/R_{SNSB}$$

The charge current and input current sense resistors convert the charge and input currents into a voltage measurable by the LTC4162. The accuracy and temperature coefficient of the current sense resistors contribute directly to the current regulation accuracy of the LTC4162. While 4-terminal resistors are available for current sensing applications, simpler 2-terminal resistors provide a more economical solution. Power dissipation of the sense resistors should be carefully considered. For example, with a 3.2A charge current the sense resistor would be 10m $\Omega$  and power dissipation would be  $3.2^2A^2 \cdot 10m\Omega = 102.4mW$ . While a 1/8W 0603 resistor is theoretically feasible in this application, its temperature rise could be quite high. A 1/4W to 1/2W 0805 resistor might be a better choice for lower thermal rise and subsequently better accuracy. Using larger copper pours and having more copper coverage will reduce the thermal resistance of the sense resistors. Figure 5 shows an example of a proper Kelvin connection to the current sense resistors.



**Figure 5. Kelvin Current Sensing with an 0805 Resistor.**



## APPLICATIONS INFORMATION

### Power Path Isolation in Ship Mode

In ship mode, the LTC4162 shuts down nearly all internal circuits and reduces its quiescent current to only a few micro-Amperes. The body diodes of the power path transistors still provide a conduction path from the battery to the system load however. If circuits down stream of the LTC4162 power path must be completely cut off in ship mode, an external PMOS transistor and one small signal NMOS transistor can provide this isolation. The circuit of Figure 6 exploits the fact that the VCC2P5 pin drops to ground in ship mode. MP1 should be chosen to have a fairly low threshold voltage if full conductance is needed for single cell applications because in the single cell case MN1 drops out and R<sub>A</sub> and R<sub>B</sub> form a voltage divider preventing full gate drive to MP1.

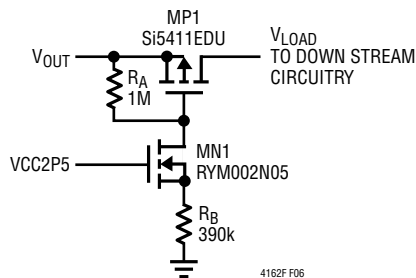


Figure 6. Isolating Downstream Circuits in Ship Mode.

### Choosing the BOOST Capacitor

The BOOST capacitor should be a low ESR surface mount ceramic type rated to at least 6.3V and should have a value of 22nF.

### Choosing the Inductor

To ensure proper ripple current and control loop stability the inductor value as a function of switching frequency and maximum input voltage should be computed from the following expression:

$$L(\mu\text{H}) = \frac{0.3 \cdot V_{\text{IN}(\text{MAX})}}{f_{\text{OSC}}(\text{MHz})}$$

Once the value for L is known, the type of inductor core must be selected. Ferrite cores are recommended for their very low core loss at frequencies above 100kHz, such as is the operating frequency of the LTC4162. Ferrite core material saturates hard, however, which means that inductance collapses abruptly when the peak design current is exceeded. This causes an abrupt increase in inductor ripple current and consequent output voltage ripple. The saturation current for the inductor should be about 30% higher than the maximum regulated current, I<sub>CHG(MAX)</sub>.

### Setting the Switching Frequency (R<sub>T</sub> Resistor)

The operating frequency and inductor selection are inter-related. Higher operating frequencies allow the use of smaller inductors and capacitors but generally also results in lower efficiency because of switching and charge transfer losses. The feedback loops of LTC4162 are internally compensated and cannot be adjusted. The LTC4162 is designed to operate properly with frequencies ranging from 1MHz to 2.5MHz. Operation at lower or higher frequencies jeopardizes control loop stability. A resistor on the R<sub>T</sub> pin sets the LTC4162's step-down switching charger operating frequency. To keep the inductor size down and ensure peak efficiency and stability, the LTC4162 has been optimized to run at 1.5MHz with an R<sub>T</sub> value of 63.4kΩ. Small changes in oscillator frequency can be achieved by altering R<sub>T</sub> from this value. The oscillator frequency is inversely proportional to R<sub>T</sub> as given by the expression:

$$f_{\text{OSC}}(\text{MHz}) = \frac{94}{R_{\text{T}}(\text{k}\Omega)}$$

### Choosing the V<sub>OUT</sub>, BATSENS+, INTV<sub>CC</sub> and VCC2P5 Bypass Capacitors

The style and value of the capacitors used with the LTC4162 determine important parameters, such as regulator control loop stability and input voltage ripple. Because the LTC4162 uses a step-down switching power supply from V<sub>OUT</sub> to BATSENS+, its input current waveform contains very high frequency components. It is imperative that low equivalent

## APPLICATIONS INFORMATION

series resistance (ESR) multilayer ceramic capacitors be used to bypass  $V_{OUT}$ . Tantalum and aluminum capacitors will not work because of their high ESR and ESL. The value of the total capacitance on  $V_{OUT}$  directly controls the amount of input ripple for a given load current. Increasing the size of this capacitor will reduce the input ripple. The LTC4162 has been designed with  $V_{OUT}$  and PGND as two corner pin groups so there is ample room to fit an appropriate bypass capacitor. The need for low impedance capacitance directly adjacent to the  $V_{OUT}$  and PGND pins cannot be overemphasized. PCB distance of only a few millimeters will introduce nano-Henrys of inductance and compromise the high frequency "hot-loop" (See Printed Circuit Board Layout Considerations).

It is also recommended that a ceramic capacitor be used to bypass BATSENS+. At least 10 $\mu$ F with low ESR is required. Multilayer ceramic chip capacitors typically have exceptional ESR performance. MLCCs combined with a tight board layout and an unbroken ground plane will yield very good performance and low EMI emissions.

The INTV<sub>CC</sub> and VCC2P5 pins are the outputs of onboard low dropout regulators and also require ceramic capacitors. The INTV<sub>CC</sub> and VCC2P5 capacitors should be as close to the LTC4162 as possible and returned immediately to an analog ground plane. The INTV<sub>CC</sub> pin requires at least 4.7 $\mu$ F of capacitance rated to at least 6.3V and the VCC2P5 pin requires at least 1 $\mu$ F rated to 4V.

The actual capacitance of any ceramic capacitor should be measured with a small AC signal and DC bias, as is expected in-circuit. Many vendors specify the capacitance versus voltage with a 1V<sub>RMS</sub> AC test signal with no bias and, as a result, grossly overstate the capacitance that the capacitor will present in the application. Using similar operating conditions as the application, the user must measure, or request from the vendor, the actual capacitance to determine if the selected capacitor meets the minimum capacitance that the application requires.

### INFET and BATFET MOSFET Selection

An external N-channel MOSFET is required for both the input and battery paths. Important parameters for the selection of these MOSFETs are the maximum drain-source voltage,  $V_{DSS}$ , gate threshold voltage and on-resistance ( $R_{DS(ON)}$ ). When the input is grounded, the battery stack voltage is applied across the input MOSFET. When  $V_{BAT}$  is at 0V, the input voltage is applied across the battery MOSFET. Therefore, the  $V_{DSS}$  of the input MOSFET must withstand the maximum voltage on  $V_{BAT}$  while the  $V_{DSS}$  of the output MOSFET must withstand the highest voltage on  $V_{IN}$ . The gate drive for both is 5V. This requires the use of logic-level threshold N-channel MOSFETs. As a general rule, select MOSFETs with a low enough  $R_{DS(ON)}$  to obtain the desired  $V_{DS}$  and power dissipation while operating at full load current.

### Operation Without a Battery

The LTC4162 has built in battery detection. Its switching regulator will generally not start if the battery is missing. However, if a battery is present at the beginning of a charge cycle and is removed, the LTC4162 will operate without a battery. Typically the BATSENS+ pin will rise quickly to the programmed constant-voltage level and remain there. However, it is important that the impedance on the BATSENS+ node be kept relatively low at the switching frequency. Therefore a ceramic capacitor of 10 $\mu$ F or more near the LTC4162 is necessary. Note that without a load on the BATSENS+ pin, the switching regulator will eventually terminate due to [tcvtimer](#) reaching [max\\_cv\\_time](#).

### Operation With Long Battery Leads

The LTC4162 is generally resilient to operation with long battery leads, however a ceramic capacitor of 10 $\mu$ F or more of appropriate voltage tolerance near the LTC4162 is necessary. Note that any parasitic battery resistance, such as long cabling, will push the LTC4162 into constant voltage charging sooner, dramatically extending charging



## APPLICATIONS INFORMATION

time. If possible, the BATSENS+ pin should be connected to the battery terminals with a separate Kelvin connection from that of the current carrying inductor path. The bulk load capacitor should be on the inductor side of this connection, not the BATSENS+ side. A smaller ceramic capacitor may additionally be added to the BATSENS+ pin near the LTC4162. A heavy copper run from the low side of battery to the GND (paddle) of the LTC4162 is also necessary to reduce resistance optimizing charging time.

### Resistive Inputs and Test Equipment

Care must be exercised in the laboratory while evaluating the LTC4162 with inline ammeters. The combined resistance of the internal current sense resistor and fuse of many meters can be  $0.5\Omega$  or more. At currents of 3A+ it is possible to drop several volts across the meter and wiring, possibly resulting in unusual voltage readings or artificially high switch duty cycles. A resistive connection to the source of input power can be particularly troublesome. With the undervoltage limit feature enabled, the switching regulator output power will be automatically reduced to prevent  $V_{IN}$  from falling below its programmed level. This feature greatly improves tolerance to resistive input power sources (from either undersized wiring and connectors or test equipment) and facilitates stable behavior, but if engaged, could result in much less power delivery to the battery.

### Solar Panel Input Impedance Correction

The maximum power point tracking algorithm uses the LTC4162's input voltage regulation control loop to find and operate at the maximum power point of the solar panel. In general solar panels have two distinct regions of operation roughly corresponding to constant voltage and constant current. In its constant voltage region the panel presents a somewhat low impedance and in its constant current region a very high impedance. Figure 7 shows an I-V characteristic collected from a brightly lit high quality 40W solar panel. Notice the very high impedance below 16V and fairly low impedance above 16V.

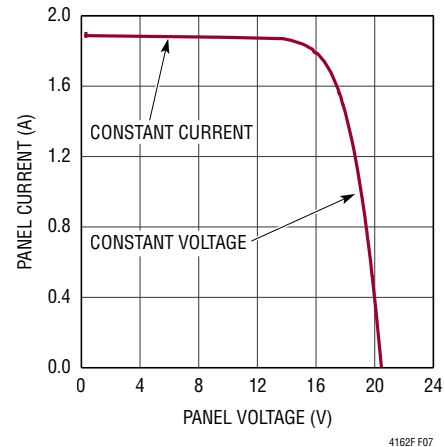


Figure 7. High Quality 40W Solar Panel

When the driving impedance is at or below a few Ohms the LTC4162's input voltage regulation loop is very stable. However, in its attempt to find the maximum power point, the LTC4162 drags the panel voltage down to its constant-current high impedance region. In this region the LTC4162 input voltage control loop will become unstable. To avoid instability and UVLO restarts the real input impedance of the LTC4162 should be maintained at about  $2.5\Omega$  in the 1kHz to 10kHz band. To achieve this characteristic an R-C network should be added to the solar panel. For example, a lower quality  $100\mu\text{F}$  to  $1000\mu\text{F}$  capacitor plus a  $2.5\Omega$  series resistor would make a good impedance correction network as shown in Figure 8.

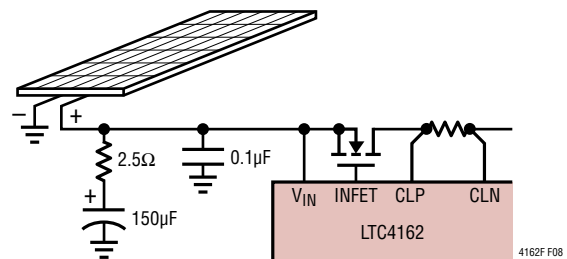


Figure 8. Input Impedance Compensation Network

Figure 9 shows the driving impedance presented by the combined solar panel plus  $10\mu\text{F}$  bypass capacitor on  $V_{OUT}$  in both low impedance and high impedance solar panel regions. In the low impedance region the aggregate impedance characteristic is about one to three Ohms in parallel

## APPLICATIONS INFORMATION

with a 10 $\mu$ F capacitor. Also shown is the troublesome constant-current region where the impedance is essentially that of just the 10 $\mu$ F bypass capacitor. Two other networks are shown comprising a larger 100 $\mu$ F and 1000 $\mu$ F capacitor both in series with a 2.5 $\Omega$  resistor for impedance flattening and phase shift mitigation. The compensation capacitor should be a solid or "polymer" electrolytic type such as the Panasonic ZA hybrid series to preserve stable ESR over temperature. Conventional, or "wet", electrolytic capacitors should be avoided as their ESR increases dramatically at low temperature. The larger compensation capacitor will create a wider impedance flattening frequency range and therefore more stable operation.

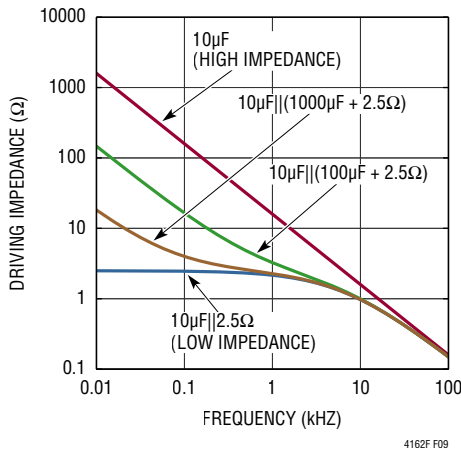


Figure 9. Aggregate Input Impedance vs Frequency

### USB Power Delivery

For 1 to 4 cell Lithium-Ion products, the LTC4162 can support the USB Power Delivery specification. Table 7 shows the relevant compatibility of `cell_count` vs USB profile.

Table 7. Cell Count Support vs USB Power Delivery Profile

USB PD Profile	1 Cell Product	2 Cell Product	3 Cell Product	4 Cell Product	5 Cell Product
5V	✓	✗	✗	✗	✗
9V	✓	✓	✗	✗	✗
15V	✓	✓	✓	✓	✗
20V	✓	✓	✓	✓	✓

### Battery and Input Voltage Hot Plugging

Aluminum-polymer, aluminum-electrolytic or tantalum capacitors can minimize overshoot when hot plugging a battery or power connector. Ceramic capacitors are required close to the LTC4162  $V_{OUT}$  pins to supply very high frequency switching current but their extreme non-linearity produces excessively high overshoot during hot plug. Their capacitance typically plunges by more than 80% as the voltage increases from 0V to rated voltage. This nonlinearity encourages high current at low voltage while rapidly shedding capacitance as the voltage rises; a dangerous combination resulting in high voltage overshoot. Empirically, the combination of a ceramic capacitor near the LTC4162 and a lower Q, voltage-stable, aluminum type capacitor provides the most robust combination. TVS diodes may also be used to limit voltage overshoot on either the input connector or the battery connector of a portable product. A single protection device (lossy capacitor or TVS) on the  $V_{OUT}$  terminal may be sufficient to handle hot plug events from either the battery or the input connector as the power path MOSFETs diode-OR to the  $V_{OUT}$  node. For solar panel applications the solar panel compensation network may provide adequate hot plug protection on the input terminal. See Application Note AN88 for examples.

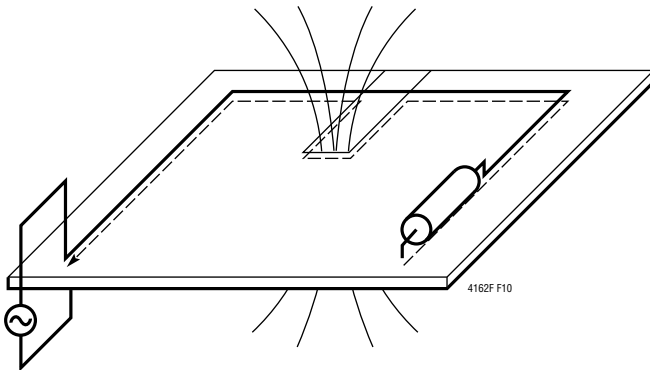
### Printed Circuit Board Layout Considerations

The Exposed Pad on the backside of the LTC4162 must be securely soldered to the PC board ground. It serves as the analog ground pin and thermal sink. There should be a group of vias under the grounded backside leading directly down to an internal unbroken ground plane.

High frequency currents tend to find their way on the ground plane along a mirror path directly beneath the incident path on the top of the board. If there are slits or cuts in the ground plane due to other traces on that layer, the current will be forced to go around the slits. If high frequency currents are not allowed to flow back through their natural, least-area, path, excessive voltage will build up and radiated emissions will occur (see Figure 10). To

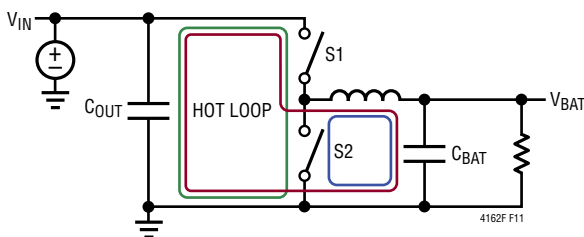
## APPLICATIONS INFORMATION

minimize parasitic inductance, the ground plane should be as close as possible to the top plane of the PC board (i.e. layer 2).

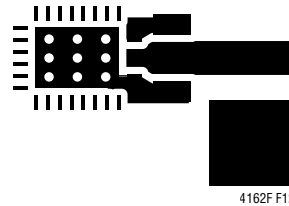


**Figure 10. Currents Tend to Follow Their Natural Least Area Path. Breaks in the Ground Plane Lead to Increased Impedance and EMI**

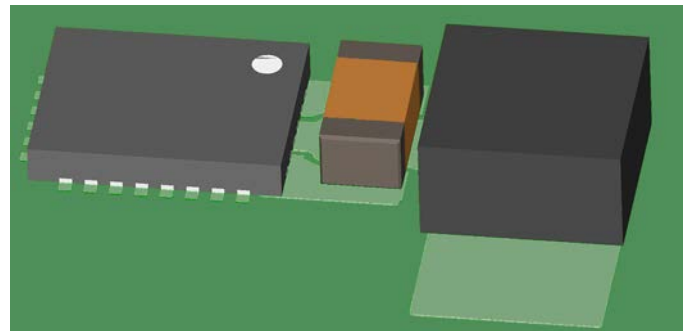
The capacitor from  $V_{OUT}$  to PGND is the most critical high frequency component. It's proximity to the LTC4162 should be prioritized above all else. The LTC4162 is designed to have this capacitor placed directly adjacent to the short side of the package where the connections to pins (27,28) and (23,24) can be made on the top copper layer of the PC board (see Figures 12 and 13). The inductor connection to SW should feed out between the input capacitor terminals or down to a lower layer with a group of vias very close to the LTC4162.



**Figure 11. Hot Loop**



**Figure 12. Recommended Placement of the  $V_{OUT}$  Bypass Capacitor and Inductor**



**Figure 13. Recommended Placement of the  $V_{OUT}$  Bypass Capacitor and Inductor**

Due to its high frequency switching circuitry, it is also imperative that the  $INTV_{CC}$  and  $VCC2P5$  LDO capacitors as well as the BOOST-SW capacitor be as close to the LTC4162 as possible. Additionally, minimizing the SW pin trace area will help minimize high frequency radiated energy.

The ceramic capacitor on BATSSENS+ carries the inductor ripple current. While not as critical as the  $V_{OUT}$  bypass capacitor, an unbroken copper pour from this capacitor's low side to the LTC4162 PGND pins (23, 24) and the analog ground pin (paddle) will reduce output voltage ripple and ensure proper regulation.

The LTC4162 demonstration board DC2038A provides an excellent example of a suitable PC board layout.

## REGISTER DESCRIPTIONS

Symbol Name	Command Code	Access	Bit Range	Default	Description
<b>vbat_lo_alert_limit</b>	0x01	R/W	[15:0]	0	Signed number that sets a lower limit that can be used to trigger an interrupt based on the per-cell battery voltage out of range. The value is based on the A/D value, <b>vbat</b> , which has a scaling factor of $\text{cell\_count} \times 192.4\mu\text{V}/\text{LSB}$ . To compute the per-cell bit count, divide the desired trigger voltage by both <b>cell_count</b> and $192.4\mu\text{V}$ . The alert is enabled by setting <b>en_vbat_lo_alert</b> and can be read back and cleared at <b>vbat_lo_alert</b> .
<b>vbat_hi_alert_limit</b>	0x02	R/W	[15:0]	0	Signed number that sets an upper limit that can be used to trigger an interrupt based on the per-cell battery voltage out of range. The value is based on the A/D value, <b>vbat</b> , which has a scaling factor of $\text{cell\_count} \times 192.4\mu\text{V}/\text{LSB}$ . To compute the per-cell bit count, divide the desired trigger voltage by both <b>cell_count</b> and $192.4\mu\text{V}$ . The alert is enabled by setting <b>en_vbat_hi_alert</b> and can be read back and cleared at <b>vbat_hi_alert</b> .
<b>vin_lo_alert_limit</b>	0x03	R/W	[15:0]	0	Signed number that sets a lower limit that can be used to trigger an interrupt based on input voltage out of range. The value is based on the A/D value, <b>vin</b> , which has a scaling factor of $1.649\text{mV}/\text{LSB}$ . The alert is enabled by setting <b>en_vin_lo_alert</b> and can be read back and cleared at <b>vin_lo_alert</b> .
<b>vin_hi_alert_limit</b>	0x04	R/W	[15:0]	0	Signed number that sets an upper limit that can be used to trigger an interrupt based on input voltage out of range. The value is based on the A/D value, <b>vin</b> , which has a scaling factor of $1.649\text{mV}/\text{LSB}$ . The alert is enabled by setting <b>en_vin_hi_alert</b> and can be read back and cleared at <b>vin_hi_alert</b> .
<b>vout_lo_alert_limit</b>	0x05	R/W	[15:0]	0	Signed number that sets a lower limit that can be used to trigger an interrupt based on <b>vout</b> voltage out of range. The value is based on the A/D value, <b>vout</b> , which has a scaling factor of $1.653\text{mV}/\text{LSB}$ . The alert is enabled by setting <b>en_vout_lo_alert</b> and can be read back and cleared at <b>vout_lo_alert</b> .
<b>vout_hi_alert_limit</b>	0x06	R/W	[15:0]	0	Signed number that sets an upper limit that can be used to trigger an interrupt based on <b>vout</b> voltage out of range. The value is based on the A/D value, <b>vout</b> , which has a scaling factor of $1.653\text{mV}/\text{LSB}$ . The alert is enabled by setting <b>en_vout_hi_alert</b> and can be read back and cleared at <b>vout_hi_alert</b> .
<b>iin_hi_alert_limit</b>	0x07	R/W	[15:0]	0	Signed number that sets an upper limit that can be used to trigger an interrupt based on input current out of range. The value is based on the A/D value, <b>iin</b> , which has a scaling factor of $1.466\mu\text{V} / \text{RSNSI amperes}/\text{LSB}$ . The alert is enabled by setting <b>en_iin_hi_alert</b> and can be read back and cleared at <b>iin_hi_alert</b> .
<b>ibat_lo_alert_limit</b>	0x08	R/W	[15:0]	0	Signed number that sets a lower limit that can be used to trigger an interrupt based on charge current dropping below a particular value, such as during the constant-voltage phase of charging, or, load current exceeding a particular limit when not charging. When the charger is not running, and telemetry is enabled with <b>force_telemetry_on</b> , this limit indicates that the battery draw has exceeded a particular value. Telemetry will be enabled automatically if the input voltage exceeds the battery voltage, in which case discharge current will be nearly zero. <b>ibat</b> values are positive for charging and negative for discharging so the polarity of this register should be set according to the mode in which the limit alert is of interest. The value is based on the A/D value, <b>ibat</b> , which has a scaling factor of $1.466\mu\text{V} / \text{RSNSB amperes}/\text{LSB}$ . The alert is enabled by setting <b>en_ibat_lo_alert</b> and can be read back and cleared at <b>ibat_lo_alert</b> .
<b>die_temp_hi_alert_limit</b>	0x09	R/W	[15:0]	0	Signed number that sets an upper limit that can be used to trigger an interrupt based on high die temperature. The value in $^{\circ}\text{C}$ can be calculated from the A/D reading, <b>die_temp</b> , as $\text{TDIE}(^{\circ}\text{C}) = \text{die\_temp} \times 0.0215^{\circ}\text{C}/\text{LSB} - 264.4^{\circ}\text{C}$ . The alert is enabled by setting <b>en_die_temp_hi_alert</b> and can be read back and cleared at <b>die_temp_hi_alert</b> .
<b>bsr_hi_alert_limit</b>	0x0A	R/W	[15:0]	0	Sets an upper limit that can be used to trigger an interrupt based on high battery resistance. The per-cell battery resistance is relative to the battery charge current setting resistor, <b>RSNSB</b> , and can be computed in $\Omega$ from: $\text{BSR} = \text{cell\_count} \times \text{bsr} \times \text{RSNSB} / 500$ . The alert is enabled by setting <b>en_bsr_hi_alert</b> and can be read back and cleared at <b>bsr_hi_alert</b> .

## REGISTER DESCRIPTIONS

Symbol Name	Command Code	Access	Bit Range	Default	Description
<b>thermistor_voltage_hi_alert_limit</b>	0x0B	R/W	[15:0]	0	Signed number that sets an upper limit that can be used to trigger an interrupt based on thermistor value out of range. The value is based on the A/D value for <a href="#">thermistor_voltage</a> . The thermistor value can be determined by the expression $RNTC = RNTCBIAS \times (21829 - \text{thermistor\_voltage}) / \text{thermistor\_voltage}$ . Recall that the thermistor has a negative temperature coefficient so higher temperatures correspond to lower <a href="#">thermistor_voltage</a> readings and vice-versa. The alert is enabled by setting <a href="#">en_thermistor_voltage_hi_alert</a> can be read back and cleared at <a href="#">thermistor_voltage_hi_alert</a> .
<b>thermistor_voltage_lo_alert_limit</b>	0x0C	R/W	[15:0]	0	Signed number that sets a lower limit that can be used to trigger an interrupt based on thermistor value out of range. The value is based on the A/D value for <a href="#">thermistor_voltage</a> . The thermistor value can be determined by the expression $RNTC = RNTCBIAS \times (21829 - \text{thermistor\_voltage}) / \text{thermistor\_voltage}$ . Recall that the thermistor has a negative temperature coefficient so higher temperatures correspond to lower <a href="#">thermistor_voltage</a> readings and vice-versa. The alert is enabled by setting <a href="#">en_thermistor_voltage_lo_alert</a> and can be read back and cleared at <a href="#">thermistor_voltage_lo_alert</a> .
<b>EN_LIMIT_ALERTS_REG</b>	0x0D	R/W	[15:0]	0	Enable limit monitoring and alert notification via SMBALERT
en_telemetry_valid_alert			[15]	0	To ensure high measurement accuracy, the telemetry system in the LTC4162 has a nominal start-up time of approximately 12ms. Setting this interrupt request causes an SMBALERT <a href="#">telemetry_valid_alert</a> when <a href="#">telemetry_valid</a> indicates that the telemetry system's readings are valid. Note that the switching battery charger will not operate until this telemetry system warmup period has passed, regardless of the state of this setting.
en_bsr_done_alert			[14]	0	Interrupt request that causes an SMBALERT upon <a href="#">bsr_done_alert</a> when the <a href="#">bsr</a> (battery-series-resistance) measurement is finished.
en_vbat_lo_alert			[11]	0	Interrupt request that causes an SMBALERT upon <a href="#">vbat_lo_alert</a> when <a href="#">vbat</a> is below <a href="#">vbat_lo_alert_limit</a> .
en_vbat_hi_alert			[10]	0	Interrupt request that causes an SMBALERT upon <a href="#">vbat_hi_alert</a> when <a href="#">vbat</a> is above <a href="#">vbat_hi_alert_limit</a> .
en_vin_lo_alert			[9]	0	Interrupt request that causes an SMBALERT upon <a href="#">vin_lo_alert</a> when <a href="#">vin</a> is below <a href="#">vin_lo_alert_limit</a> .
en_vin_hi_alert			[8]	0	Interrupt request that causes an SMBALERT upon <a href="#">vin_hi_alert</a> when <a href="#">vin</a> is above <a href="#">vin_hi_alert_limit</a> .
en_vout_lo_alert			[7]	0	Interrupt request that causes an SMBALERT upon <a href="#">vout_lo_alert</a> when <a href="#">vout</a> is below <a href="#">vout_lo_alert_limit</a> .
en_vout_hi_alert			[6]	0	Interrupt request that causes an SMBALERT upon <a href="#">vout_hi_alert</a> when <a href="#">vout</a> is above <a href="#">vout_hi_alert_limit</a> .
en_iin_hi_alert			[5]	0	Interrupt request that causes an SMBALERT upon <a href="#">iin_hi_alert</a> when <a href="#">iin</a> is above <a href="#">iin_hi_alert_limit</a> .
en_ibat_lo_alert			[4]	0	Interrupt request that causes an SMBALERT upon <a href="#">ibat_lo_alert</a> when <a href="#">ibat</a> is below <a href="#">ibat_lo_alert_limit</a> .
en_die_temp_hi_alert			[3]	0	Interrupt request that causes an SMBALERT upon <a href="#">die_temp_hi_alert</a> when <a href="#">die_temp</a> is above <a href="#">die_temp_hi_alert_limit</a> .
en_bsr_hi_alert			[2]	0	Interrupt request that causes an SMBALERT upon <a href="#">bsr_hi_alert</a> when <a href="#">bsr</a> is above <a href="#">bsr_hi_alert_limit</a> .
en_thermistor_voltage_hi_alert			[1]	0	Interrupt request that causes an SMBALERT upon <a href="#">thermistor_voltage_hi_alert</a> when <a href="#">thermistor_voltage</a> is above <a href="#">thermistor_voltage_hi_alert_limit</a> . Recall that the thermistor has a negative temperature coefficient so higher <a href="#">thermistor_voltage</a> readings correspond to lower temperatures.
en_thermistor_voltage_lo_alert			[0]	0	Interrupt request that causes an SMBALERT upon <a href="#">thermistor_voltage_lo_alert</a> when <a href="#">thermistor_voltage</a> is below <a href="#">thermistor_voltage_lo_alert_limit</a> . Recall that the thermistor has a negative temperature coefficient so lower <a href="#">thermistor_voltage</a> readings correspond to higher temperatures.



## REGISTER DESCRIPTIONS

Symbol Name	Command Code	Access	Bit Range	Default	Description
<b>EN_CHARGER_STATE_ALERTS_REG</b>	0x0E	R/W	[12:0]	0	Enable charger state notification via SMBALERT
en_bat_detect_failed_fault_alert			[12]	0	Interrupt request that causes an SMBALERT upon <a href="#">bat_detect_failed_fault_alert</a> as indicated by <a href="#">bat_detect_failed_fault</a> due to an inability to source power to the battery during battery detection testing (usually due to either <a href="#">iin_limit_active</a> or <a href="#">vin_uvcl_active</a> ).
en_battery_detection_alert			[11]	0	Interrupt request that causes an SMBALERT upon <a href="#">battery_detection_alert</a> as indicated by <a href="#">battery_detection</a> due to the LTC4162 entering battery detection testing.
en_absorb_charge_alert			[9]	0	Interrupt request that causes an SMBALERT upon <a href="#">absorb_charge_alert</a> when the <a href="#">absorb_charge</a> phase of a battery charge cycle begins.
en_charger_suspended_alert			[8]	0	Interrupt request that causes an SMBALERT upon <a href="#">charger_suspended_alert</a> as indicated by <a href="#">charger_suspended</a> whereby battery charging is terminated due to <a href="#">suspend_charger</a> or <a href="#">thermistor_voltage</a> out of <a href="#">jeita_t1</a> - <a href="#">jeita_t6</a> range.
en_cc_cv_charge_alert			[6]	0	Interrupt request that causes an SMBALERT upon <a href="#">cc_cv_charge_alert</a> as indicated by <a href="#">cc_cv_charge</a> denoting the onset of the constant current / constant voltage phase of a battery charging cycle.
en_ntc_pause_alert			[5]	0	Interrupt request that causes an SMBALERT upon <a href="#">ntc_pause_alert</a> as indicated by <a href="#">ntc_pause</a> whereby a battery charge cycle is interrupted due to <a href="#">thermistor_voltage</a> out of range as set by the <a href="#">jeita_t1</a> through <a href="#">jeita_t6</a> values.
en_timer_term_alert			[4]	0	Interrupt request that causes an SMBALERT upon <a href="#">timer_term_alert</a> as indicated by <a href="#">timer_term</a> whereby a battery charge cycle terminates due to <a href="#">tcvtimer</a> reaching <a href="#">max_cv_time</a> , the maximum time allowed in <a href="#">constant_voltage</a> mode.
en_c_over_x_term_alert			[3]	0	Interrupt request that causes an SMBALERT upon <a href="#">c_over_x_term_alert</a> as indicated by <a href="#">c_over_x_term</a> whereby a battery charge cycle terminates due to <a href="#">ibat</a> dropping below the <a href="#">c_over_x_threshold</a> .
en_max_charge_time_alert			[2]	0	Interrupt request that causes an SMBALERT upon <a href="#">max_charge_time_fault_alert</a> as indicated by <a href="#">max_charge_time_fault</a> whereby charging has terminated due to <a href="#">tchargetimer</a> reaching <a href="#">max_charge_time</a> .
en_bat_missing_fault_alert			[1]	0	Interrupt request that causes an SMBALERT upon <a href="#">bat_missing_fault_alert</a> as indicated by <a href="#">bat_missing_fault</a> whereby charging is prohibited if no battery is detected during the battery presence detection phase at the beginning of a charge cycle.
en_bat_short_fault_alert			[0]	0	Interrupt request that causes an SMBALERT upon <a href="#">bat_short_fault_alert</a> as indicated by <a href="#">bat_short_fault</a> whereby charging is prohibited if a shorted battery is detected during the battery presence detection phase at the beginning of a charge cycle.
<b>EN_CHARGE_STATUS_ALERTS_REG</b>	0x0F	R/W	[5:0]	0	Enable charge status notification via SMBALERT
en_ilim_reg_active_alert			[5]	0	Interrupt request that causes an <a href="#">ilim_reg_active_alert</a> SMBALERT upon <a href="#">ilim_reg_active</a> (VCSP-VCSN greater than 45mV). May indicate that the switching regulator is currently controlling power delivery based on a safety current limit. This should not occur under normal conditions and is likely the result of a circuit board fault. Alternately indicates that the switching regulator is in dropout (near 100% duty cycle) and is not regulating on any feedback control loop.
en_thermal_reg_active_alert			[4]	0	Interrupt request that causes a <a href="#">thermal_reg_active_alert</a> SMBALERT upon <a href="#">thermal_reg_active</a> indicating that the <a href="#">icharge_dac</a> is being dialed back to reduce internal die heating.
en_vin_uvcl_active_alert			[3]	0	Interrupt request that causes a <a href="#">vin_uvcl_active_alert</a> SMBALERT upon <a href="#">vin_uvcl_active</a> indicating that the undervoltage regulation loop has taken control of the switching regulator.
en_iin_limit_active_alert			[2]	0	Interrupt request that causes a <a href="#">iin_limit_active_alert</a> SMBALERT upon <a href="#">iin_limit_active</a> indicating that the input current regulation loop has taken control of the switching regulator.
en_constant_current_alert			[1]	0	Interrupt request that causes a <a href="#">constant_current_alert</a> SMBALERT upon <a href="#">constant_current</a> indicating that the battery charger constant current regulation loop has taken control of the switching regulator.

## REGISTER DESCRIPTIONS

Symbol Name	Command Code	Access	Bit Range	Default	Description
en_constant_voltage_alert			[0]	0	Interrupt request that causes a <a href="#">constant_voltage_alert</a> SMBALERT upon <a href="#">constant_voltage</a> indicating that the battery charger constant voltage regulation loop has taken control of the switching regulator.
thermal_reg_start_temp	0x10	R/W	[15:0]	17897	Signed number that sets the start of the temperature region for thermal regulation. To prevent overheating, a thermal regulation feedback loop utilizing <a href="#">die_temp</a> sets an upper limit on <a href="#">icharge_dac</a> following a linear gradient from full scale (31) to minimum scale (0) between <a href="#">thermal_reg_start_temp</a> and <a href="#">thermal_reg_end_temp</a> . The default value of 17897 corresponds to 120°C.
thermal_reg_end_temp	0x11	R/W	[15:0]	18130	Signed number that sets the end of the temperature region for thermal regulation. To prevent overheating, a thermal regulation feedback loop utilizing <a href="#">die_temp</a> sets an upper limit on <a href="#">icharge_dac</a> following a linear gradient from full scale (31) to minimum scale (0) between <a href="#">thermal_reg_start_temp</a> and <a href="#">thermal_reg_end_temp</a> . The default value of 18130 corresponds to 125°C.
CONFIG_BITS_REG	0x14	R/W	[5:1]	0	System configuration settings
suspend_charger			[5]	0	Causes battery charging to be suspended. This setting should be used cautiously. For embedded battery systems where two wire interface communication relies on a minimum battery voltage, setting this bit could result in a deadlock that may require factory service to correct.
run_bsr			[4]	0	Causes the battery equivalent-series-resistance ( <a href="#">bsr</a> ) measurement to be made as soon as a charge cycle starts or immediately if a charge cycle is already running.
telemetry_speed			[3]	0	Forces the telemetry system to take measurements at the higher rate of approximately once every 11ms whenever the telemetry system is on. When this bit is disabled, the telemetry system will slow down to about once every 5s to reduce power when not charging. Setting <a href="#">telemetry_speed</a> to <a href="#">tel_high_speed</a> in conjunction with <a href="#">force_telemetry_on</a> with no input power available will increase battery drain. Enums: <a href="#">tel_high_speed</a> = 1, <a href="#">tel_low_speed</a> = 0
force_telemetry_on			[2]	0	Causes the telemetry system to operate at all times, including times when only battery power is available.
mppt_en			[1]	0	Causes the Maximum Power-Point Tracking algorithm to run. The maximum power point algorithm takes control of the input undervoltage regulation control loop via the <a href="#">input_undervoltage_dac</a> to seek the optimum power-point for resistive sources such as a long cable or solar panel.
iin_limit_target	0x15	R/W	[5:0]	63	Controls the target input current limit setting. The input current is limited by regulating charge current in response to the voltage across an external current sense resistor, RSNSI, between the CLP and CLN pins and is given by $(iin\_limit\_target + 1) \times 500\mu V / RSNSI$ . Note that the LTC4162 can only limit charge current based on this setting. It does not have the authority to block current from passing directly through to the system load. Connecting the system load to the battery, however, can allow total input current control.
input_undervoltage_setting	0x16	R/W	[7:0]	31	Controls the input undervoltage regulation setting. The regulation voltage, given by $(input\_undervoltage\_setting + 1) \times 140.625mV$ , is the voltage at which the charge current will be reduced to prevent further droop in supply voltage due to a resistive source. If <a href="#">mppt_en</a> is set, the MPPT algorithm will override this setting. The actual input undervoltage value can be read back from the <a href="#">input_undervoltage_dac</a> .
arm_ship_mode	0x19	R/W	[15:0]	0	Setting this register to <a href="#">arm</a> arms the ultra low-power ship and store mode. Ship mode does not take effect until the VIN pin drops below approximately 1V or immediately if VIN is already below 1V. Enum: <a href="#">arm</a> = 21325

## REGISTER DESCRIPTIONS

Symbol Name	Command Code	Access	Bit Range	Default	Description
<b>charge_current_setting</b>	0x1A	R/W	[4:0]	31	Controls the target charge current regulation servo level. The charge current is regulated by servoing the voltage across an external current sense resistor, RSNSB, between the CSP and CSN pins. The servo voltage is given by $(\text{charge\_current\_setting} + 1) \times 1\text{mV}$ . The effective charge current, determined by the external resistor, RSNSB, is given by $(\text{charge\_current\_setting} + 1) \times 1\text{mV} / \text{RSNSB}$ . <code>icharge_dac</code> will follow <code>charge_current_setting</code> unless <code>thermal_reg_active</code> is true or the JEITA algorithm, with <code>en_jeita</code> , has altered it.
<b>vcharge_setting</b>	0x1B	R/W	[4:0]	31	Controls the final charge voltage regulation servo level. To maintain inherent over-charge protection, only LiFePO4 appropriate charge voltage values can be selected. The charge voltage setting can be computed from $\text{cell\_count} \times (\text{vcharge\_setting} \times 12.5\text{mV} + 3.4125\text{V})$ where <code>vcharge_setting</code> also ranges from 0 to 31 (3.8V max). <code>vcharge_dac</code> will follow <code>vcharge_setting</code> unless the advanced JEITA temperature control system ( <code>en_jeita</code> ) has altered it. Enums: <code>vcharge_lifepo4_default</code> = 31, <code>vcharge_lifepo4_3p6v</code> = 15
<b>c_over_x_threshold</b>	0x1C	R/W	[15:0]	2184	Signed number that sets the <code>ibat</code> A/D value used to qualify C/x detection and termination. The C/x level is based on the value for <code>ibat</code> which has a scaling factor of $1.466\mu\text{V} / \text{RSNSB amperes/LSB}$ . For example, to make the C/x level C/10 (a very common choice) then <code>c_over_x_threshold</code> should be set to <code>c_over_10</code> which is 10% of the maximum possible <code>ibat</code> reading ( $32\text{mV} \times 37.5 \times 18,191 / 10$ ). 32mV is the full scale charge current signal from CSP to CSN, 37.5 is the internal charge amplifier's gain and 18,191 is the A/D's span term in counts per Volt. Enum: <code>c_over_10</code> = 2184
<b>max_cv_time</b>	0x1D	R/W	[15:0]	3600	Sets the constant-voltage termination setting against which the <code>tcvtimer</code> is compared. The timer begins at the onset of the <code>constant_voltage</code> phase of charging and increments at one count per second. The default setting is 3,600 (1 hour). Setting this value to 0 disables the constant-voltage termination feature. Enums: <code>cvtimer_disabled</code> = 0, <code>30mins</code> = 1800, <code>1hour_default</code> = 3600, <code>2hours</code> = 7200, <code>4hours</code> = 14400
<b>max_charge_time</b>	0x1E	R/W	[15:0]	0	Sets the total charge time termination setting against which the <code>tchargetimer</code> is compared. The default value of 0 disables the total charge time feature and prevents the <code>tchargetimer</code> from running. If enabled with a non zero value, the <code>tchargetimer</code> begins counting at the onset of a charge cycle and increments at one count per minute. Enum: <code>maxchargetime_disable</code> = 0
<b>jeita_t1</b>	0x1F	R/W	[15:0]	16117	Signed number that sets the JEITA temperature region transition temperature T1 between JEITA regions <code>R1</code> and <code>R2</code> . The temperature is based on the thermistor reading from the telemetry system; $\text{RNTC} = \text{RNTCBIAS} \times (21829 - \text{thermistor\_voltage}) / \text{thermistor\_voltage}$ . Recall that the thermistor has a negative temperature coefficient so <code>jeita_t1</code> , representing colder temperatures, will have the highest value and <code>jeita_t6</code> , representing warmer temperatures, will have the lowest value. The default value of 16117 maps to about 0°C for the expected thermistor $\beta$ value of 3490K.
<b>jeita_t2</b>	0x20	R/W	[15:0]	14113	Signed number that sets the JEITA temperature region transition temperature T2 between JEITA regions <code>R2</code> and <code>R3</code> . The temperature is based on the thermistor reading from the telemetry system; $\text{RNTC} = \text{RNTCBIAS} \times (21829 - \text{thermistor\_voltage}) / \text{thermistor\_voltage}$ . Recall that the thermistor has a negative temperature coefficient so <code>jeita_t1</code> , representing colder temperatures, will have the highest value and <code>jeita_t6</code> , representing warmer temperatures, will have the lowest value. The default value of 14113 maps to about 10°C for the expected thermistor $\beta$ value of 3490K.



## REGISTER DESCRIPTIONS

Symbol Name	Command Code	Access	Bit Range	Default	Description
jeita_t3	0x21	R/W	[15:0]	7970	Signed number that sets the JEITA temperature region transition temperature T3 between JEITA regions <b>R3</b> and <b>R4</b> . The temperature is based on the thermistor reading from the telemetry system; $RNTC = RNTCBIAS \times (21829 - \text{thermistor\_voltage}) / \text{thermistor\_voltage}$ . Recall that the thermistor has a negative temperature coefficient so <b>jeita_t1</b> , representing colder temperatures, will have the highest value and <b>jeita_t6</b> , representing warmer temperatures, will have the lowest value. The default value of 7970 maps to about 40°C for the expected thermistor $\beta$ value of 3490K.
jeita_t4	0x22	R/W	[15:0]	7112	Signed number that sets the JEITA temperature region transition temperature T4 between JEITA regions <b>R3</b> and <b>R4</b> . The temperature is based on the thermistor reading from the telemetry system; $RNTC = RNTCBIAS \times (21829 - \text{thermistor\_voltage}) / \text{thermistor\_voltage}$ . Recall that the thermistor has a negative temperature coefficient so <b>jeita_t1</b> , representing colder temperatures, will have the highest value and <b>jeita_t6</b> , representing warmer temperatures, will have the lowest value. The default value of 7112 maps to about 45°C for the expected thermistor $\beta$ value of 3490K.
jeita_t5	0x23	R/W	[15:0]	6325	Signed number that sets the JEITA temperature region transition temperature T5 between JEITA regions <b>R5</b> and <b>R6</b> . The temperature is based on the thermistor reading from the telemetry system; $RNTC = RNTCBIAS \times (21829 - \text{thermistor\_voltage}) / \text{thermistor\_voltage}$ . Recall that the thermistor has a negative temperature coefficient so <b>jeita_t1</b> , representing colder temperatures, will have the highest value and <b>jeita_t6</b> , representing warmer temperatures, will have the lowest value. The default value of 6325 maps to about 50°C for the expected thermistor $\beta$ value of 3490K.
jeita_t6	0x24	R/W	[15:0]	4970	Signed number that sets the JEITA temperature region transition temperature T6 between JEITA regions <b>R6</b> and <b>R7</b> . The temperature is based on the thermistor reading from the telemetry system; $RNTC = RNTCBIAS \times (21829 - \text{thermistor\_voltage}) / \text{thermistor\_voltage}$ . Recall that the thermistor has a negative temperature coefficient so <b>jeita_t1</b> , representing colder temperatures, will have the highest value and <b>jeita_t6</b> , representing warmer temperatures, will have the lowest value. The default value of 4970 maps to about 60°C for the expected thermistor $\beta$ value of 3490K.
<b>VCHARGE_</b> <b>JEITA_6_5_REG</b>	0x25	R/W	[9:0]	103	<b>vcharge_setting</b> values for JEITA temperature regions <b>jeita_t6</b> and <b>jeita_t5</b>
vcharge_jeita_6			[9:5]	3	Sets the charge voltage to be used in JEITA region 6 as illustrated in the JEITA Temperature Qualified Charging section. The value corresponds to <b>vcharge_setting</b> and can be calculated using $\text{vcharge\_jeita\_6} \times 12.5\text{mV} + 3.4125\text{V}$ . The default value of 3 corresponds to 3.45V.
vcharge_jeita_5			[4:0]	7	Sets the charge voltage to be used in JEITA region 5 as illustrated in the JEITA Temperature Qualified Charging section. The value corresponds to <b>vcharge_setting</b> and can be calculated using $\text{vcharge\_jeita\_5} \times 12.5\text{mV} + 3.4125\text{V}$ . The default value of 7 corresponds to 3.5V.
<b>VCHARGE_</b> <b>JEITA_4_3_2_REG</b>	0x26	R/W	[14:0]	7663	<b>vcharge_setting</b> values for JEITA temperature regions <b>jeita_t4</b> , <b>jeita_t3</b> , and <b>jeita_t2</b>
vcharge_jeita_4			[14:10]	7	Sets the charge voltage to be used in JEITA region 4 as illustrated in the JEITA Temperature Qualified Charging section. The value corresponds to <b>vcharge_setting</b> and can be calculated using $\text{vcharge\_jeita\_4} \times 12.5\text{mV} + 3.4125\text{V}$ . The default value of 7 corresponds to 3.5V.
vcharge_jeita_3			[9:5]	15	Sets the charge voltage to be used in JEITA region 3 as illustrated in the JEITA Temperature Qualified Charging section. The value corresponds to <b>vcharge_setting</b> and can be calculated using $\text{vcharge\_jeita\_3} \times 12.5\text{mV} + 3.4125\text{V}$ . The default value of 15 corresponds to 3.6V.
vcharge_jeita_2			[4:0]	15	Sets the charge voltage to be used in JEITA region 2 as illustrated in the JEITA Temperature Qualified Charging section. The value corresponds to <b>vcharge_setting</b> and can be calculated using $\text{vcharge\_jeita\_2} \times 12.5\text{mV} + 3.4125\text{V}$ . The default value of 15 corresponds to 3.6V.
<b>ICHARGE_</b> <b>JEITA_6_5_REG</b>	0x27	R/W	[9:0]	495	<b>charge_current_setting</b> values for JEITA temperature regions <b>jeita_t6</b> and <b>jeita_t5</b>
icharge_jeita_6			[9:5]	15	Sets the charge current to be used in JEITA region 6 as illustrated in the JEITA Temperature Qualified Charging section. The value corresponds to <b>charge_current_setting</b> where the charge current can be calculated using $(\text{icharge\_jeita\_6} + 1) \times 1\text{mV} / \text{RSNSB}$ . The default value of 15 corresponds to a VCSP-VCSN servo voltage of 16mV which is half scale or C/2.

## REGISTER DESCRIPTIONS

Symbol Name	Command Code	Access	Bit Range	Default	Description
icharge_jeita_5			[4:0]	15	Sets the charge current to be used in JEITA region 5 as illustrated in the JEITA Temperature Qualified Charging section. The value corresponds to <a href="#">charge_current_setting</a> where the charge current can be calculated using $(\text{icharge\_jeita\_5} + 1) \times 1\text{mV} / \text{RSNSB}$ . The default value of 15 corresponds to a VCSP-VCSN servo voltage of 16mV which is half scale or C/2.
<b>ICHARGE_JEITA_4_3_2_REG</b>	0x28	R/W	[14:0]	32751	<a href="#">charge_current_setting</a> value for JEITA temperature regions <a href="#">jeita_t4</a> , <a href="#">jeita_t3</a> , and <a href="#">jeita_t2</a>
icharge_jeita_4			[14:10]	31	Sets the charge current to be used in JEITA region 4 as illustrated in the JEITA Temperature Qualified Charging section. The value corresponds to <a href="#">charge_current_setting</a> where the charge current can be calculated using $(\text{icharge\_jeita\_4} + 1) \times 1\text{mV} / \text{RSNSB}$ . The default value of 31 corresponds to a VCSP-VCSN servo voltage of 32mV which is full scale.
icharge_jeita_3			[9:5]	31	Sets the charge current to be used in JEITA region 3 as illustrated in the JEITA Temperature Qualified Charging section. The value corresponds to <a href="#">charge_current_setting</a> where the charge current can be calculated using $(\text{icharge\_jeita\_3} + 1) \times 1\text{mV} / \text{RSNSB}$ . The default value of 31 corresponds to a VCSP-VCSN servo voltage of 32mV which is full scale.
icharge_jeita_2			[4:0]	15	Sets the charge current to be used in JEITA region 2 as illustrated in the JEITA Temperature Qualified Charging section. The value corresponds to <a href="#">charge_current_setting</a> where the charge current can be calculated using $(\text{icharge\_jeita\_2} + 1) \times 1\text{mV} / \text{RSNSB}$ . The default value of 15 corresponds to a VCSP-VCSN servo voltage of 16mV which is half scale or C/2.
<b>CHARGER_CONFIG_BITS_REG</b>	0x29	R/W	[2:0]	1	Battery charger configuration settings
en_c_over_x_term			[2]	0	Enables charge current based (C/x) battery charger termination as set by <a href="#">ibat</a> dropping to the <a href="#">c_over_x_threshold</a> in <a href="#">constant_voltage</a> .
en_jeita			[0]	1	Enables the JEITA temperature qualified charging system.
<b>vabsorb_delta</b>	0x2A	R/W	[4:0]	0	Controls the absorb adder voltage in the absorb charging phase. The absorb charging phase cell voltage servo level is based on the sum of this value and the <a href="#">vcharge_setting</a> or <a href="#">vcharge_jeita_1</a> to <a href="#">vcharge_jeita_6</a> levels. The absorb voltage level is given by $\text{cell\_count} \times (\text{vabsorb\_delta} + \text{vcharge\_setting}) \times 12.5\text{mV} + 3.4125\text{V}$ but is limited by hardware to a maximum of 3.8 V/cell_count. The default value of 0 disables the absorb, or rapid charging, feature. Enum: <a href="#">absorb_disable</a> = 0
<b>max_absorb_time</b>	0x2B	R/W	[15:0]	0	At 1 second per count, this register sets an upper limit on the time the LTC4162 can be in the absorb, or rapid, charge phase. The actual timer value is reported in <a href="#">tabsorbtimer</a> . Enums: <a href="#">absorb_15mins</a> = 900, <a href="#">absorb_30mins</a> = 1800, <a href="#">absorb_1hours</a> = 3600, <a href="#">absorb_90mins</a> = 5400, <a href="#">absorb_2hours</a> = 7200
<b>v_recharge_lifepo4</b>	0x2E	R/W	[15:0]	17424	Signed number that controls the recharge threshold voltage. After termination the LTC4162 will begin a new charge cycle if <a href="#">vbat</a> drops to this value. The default value of 17,424 corresponds to $17,424 / 18,191 \times 3.5 \times \text{cell\_count}$ or about 3.35V / cell.
<b>tchargetimer</b>	0x30	R	[15:0]	0	If <a href="#">max_charge_time</a> is written to a non zero value <a href="#">tchargetimer</a> is the elapsed time in minutes since the beginning of a charge cycle. The LTC4162 will terminate charging when <a href="#">tchargetimer</a> reaches the value in <a href="#">max_charge_time</a> .
<b>tcvtimer</b>	0x31	R	[15:0]	0	This is the elapsed time in seconds since the battery charger has been in the <a href="#">constant_voltage</a> phase of charging. If this value exceeds <a href="#">max_cv_time</a> then charging is considered complete and will terminate. The constant-voltage timer can be disabled by setting <a href="#">max_cv_time</a> to 0.
<b>tabsorbtimer</b>	0x32	R	[15:0]	0	This is the elapsed time in seconds that the LTC4162 has been in the absorb phase of charging. If this value exceeds <a href="#">max_absorb_time</a> , the absorb phase is terminated and normal charging resumes.

## REGISTER DESCRIPTIONS

Symbol Name	Command Code	Access	Bit Range	Default	Description
<b>charger_state</b>	0x34	R	[12:0]	256	Real time battery charger state indicator. Individual bits are mutually exclusive. Enums: <a href="#">bat_detect_failed_fault</a> = 4096, <a href="#">battery_detection</a> = 2048, <a href="#">absorb_charge</a> = 512, <a href="#">charger_suspended</a> = 256, <a href="#">cc_cv_charge</a> = 64, <a href="#">ntc_pause</a> = 32, <a href="#">timer_term</a> = 16, <a href="#">c_over_x_term</a> = 8, <a href="#">max_charge_time_fault</a> = 4, <a href="#">bat_missing_fault</a> = 2, <a href="#">bat_short_fault</a> = 1
<b>charge_status</b>	0x35	R	[5:0]	0	Charge status indicator. Individual bits are mutually exclusive and are only active in charging states. Enums: <a href="#">ilim_reg_active</a> = 32, <a href="#">thermal_reg_active</a> = 16, <a href="#">vin_uvcl_active</a> = 8, <a href="#">iin_limit_active</a> = 4, <a href="#">constant_current</a> = 2, <a href="#">constant_voltage</a> = 1, <a href="#">charger_off</a> = 0
<b>LIMIT_ALERTS_REG</b>	0x36	R	[15:0]	0	Limit alert register. This input/output register indicates that an enabled alert has occurred. Individual alerts are enabled in <a href="#">EN_LIMIT_ALERTS_REG</a> . Writing 0 to any bit clears that alert. Once set, alert bits remain high until cleared or disabled.
telemetry_valid_alert			[15]	0	Alert that indicates that the telemetry system warm-up time has expired and valid telemetry data is available from the serial port. This alert bit is cleared by writing it back to 0 with the remaining bits in this register set to 1s. It can also be cleared by clearing <a href="#">en_telemetry_valid_alert</a> .
bsr_done_alert			[14]	0	Alert that indicates that the battery equivalent-series-resistance measurement is finished and a result is available in <a href="#">bsr</a> . This alert bit is cleared by writing it back to 0 with the remaining bits in this register set to 1s. It can also be cleared by clearing <a href="#">en_bsr_done_alert</a> .
vbat_lo_alert			[11]	0	Alert that indicates that <a href="#">vbat</a> is below the value set by <a href="#">vbat_lo_alert_limit</a> . This alert bit is cleared by writing it back to 0 with the remaining bits in this register set to 1s. It can also be cleared by clearing <a href="#">en_vbat_lo_alert</a> .
vbat_hi_alert			[10]	0	Alert that indicates that <a href="#">vbat</a> is above the value set by <a href="#">vbat_hi_alert_limit</a> . This alert bit is cleared by writing it back to 0 with the remaining bits in this register set to 1s. It can also be cleared by clearing <a href="#">en_vbat_hi_alert</a> .
vin_lo_alert			[9]	0	Alert that indicates that <a href="#">vin</a> is below the value set by <a href="#">vin_lo_alert_limit</a> . This alert bit is cleared by writing it back to 0 with the remaining bits in this register set to 1s. It can also be cleared by clearing <a href="#">en_vin_lo_alert</a> .
vin_hi_alert			[8]	0	Alert that indicates that <a href="#">vin</a> is above the value set by <a href="#">vin_hi_alert_limit</a> . This alert bit is cleared by writing it back to 0 with the remaining bits in this register set to 1s. It can also be cleared by clearing <a href="#">en_vin_hi_alert</a> .
vout_lo_alert			[7]	0	Alert that indicates that <a href="#">vout</a> is below the value set by <a href="#">vout_lo_alert_limit</a> . This alert bit is cleared by writing it back to 0 with the remaining bits in this register set to 1s. It can also be cleared by clearing <a href="#">en_vout_lo_alert</a> .

## REGISTER DESCRIPTIONS

Symbol Name	Command Code	Access	Bit Range	Default	Description
vout_hi_alert			[6]	0	Alert that indicates that <b>vout</b> is above the value set by <b>vout_hi_alert_limit</b> . This alert bit is cleared by writing it back to 0 with the remaining bits in this register set to 1s. It can also be cleared by clearing <b>en_vout_hi_alert</b> .
iin_hi_alert			[5]	0	Alert that indicates that <b>iin</b> is above the value set by <b>iin_hi_alert_limit</b> . This alert bit is cleared by writing it back to 0 with the remaining bits in this register set to 1s. It can also be cleared by clearing <b>en_iin_hi_alert</b> .
ibat_lo_alert			[4]	0	Alert that indicates that <b>ibat</b> is below the value set by <b>ibat_lo_alert_limit</b> . This alert bit is cleared by writing it back to 0 with the remaining bits in this register set to 1s. It can also be cleared by clearing <b>en_ibat_lo_alert</b> .
die_temp_hi_alert			[3]	0	Alert that indicates that <b>die_temp</b> is above the value set by <b>die_temp_hi_alert_limit</b> . This alert bit is cleared by writing it back to 0 with the remaining bits in this register set to 1s. It can also be cleared by clearing <b>en_die_temp_hi_alert</b> .
bssr_hi_alert			[2]	0	Alert that indicates that <b>bssr</b> is above the value set by <b>bssr_hi_alert_limit</b> . This alert bit is cleared by writing it back to 0 with the remaining bits in this register set to 1s. It can also be cleared by clearing <b>en_bssr_hi_alert</b> .
thermistor_voltage_hi_alert			[1]	0	Alert that indicates that <b>thermistor_voltage</b> is above the value set by <b>thermistor_voltage_hi_alert_limit</b> . This alert bit is cleared by writing it back to 0 with the remaining bits in this register set to 1s. It can also be cleared by clearing <b>en_thermistor_voltage_hi_alert</b> .
thermistor_voltage_lo_alert			[0]	0	Alert that indicates that <b>thermistor_voltage</b> is below the value set by <b>thermistor_voltage_lo_alert_limit</b> . This alert bit is cleared by writing it back to 0 with the remaining bits in this register set to 1s. It can also be cleared by clearing <b>en_thermistor_voltage_lo_alert</b> .
<b>CHARGER_STATE_ALERTS_REG</b>	0x37	R	[12:0]	0	Alert that indicates that charger states have occurred. Individual bits are enabled by <b>EN_CHARGER_STATE_ALERTS_REG</b> . Writing 0 to any bit while writing 1s to the remaining bits clears that alert. Once set, alert bits remain high until cleared or disabled.
bat_detect_failed_fault_alert			[12]	0	Alert that indicates a <b>bat_detect_failed_fault</b> . This alert bit is cleared by writing it back to 0 with the remaining bits in this register set to 1s. It can also be cleared by clearing <b>en_bat_detect_failed_fault_alert</b> .
battery_detection_alert			[11]	0	Alert that indicates the battery charger is performing <b>battery_detection</b> . This alert bit is cleared by writing it back to 0 with the remaining bits in this register set to 1s. It can also be cleared by clearing <b>en_battery_detection_alert</b> .
charger_suspended_alert			[8]	0	Alert that indicates the battery charger is in the <b>charger_suspended</b> state. This alert bit is cleared by writing it back to 0 with the remaining bits in this register set to 1s. It can also be cleared by clearing <b>en_charger_suspended_alert</b> .
cc_cv_charge_alert			[6]	0	Alert that indicates that the battery charge is in the <b>cc_cv_charge</b> phase. This alert bit is cleared by writing it back to 0 with the remaining bits in this register set to 1s. It can also be cleared by clearing <b>en_cc_cv_charge_alert</b> .
ntc_pause_alert			[5]	0	Alert that indicates that the battery charger is in the <b>ntc_pause</b> state. This alert bit is cleared by writing it back to 0 with the remaining bits in this register set to 1s. It can also be cleared by clearing <b>en_ntc_pause_alert</b> .
timer_term_alert			[4]	0	Alert that indicates that the battery charge is in the <b>timer_term</b> state. This alert bit is cleared by writing it back to 0 with the remaining bits in this register set to 1s. It can also be cleared by clearing <b>en_timer_term_alert</b> .
c_over_x_term_alert			[3]	0	Alert that indicates that the battery charge is in the <b>c_over_x_term</b> state. This alert bit is cleared by writing it back to 0 with the remaining bits in this register set to 1s. It can also be cleared by clearing <b>en_c_over_x_term_alert</b> .
max_charge_time_fault_alert			[2]	0	Alert that indicates that the battery charge is in the <b>max_charge_time_fault</b> state. This alert bit is cleared by writing it back to 0 with the remaining bits in this register set to 1s. It can also be cleared by clearing <b>en_max_charge_time_fault_alert</b> .
bat_missing_fault_alert			[1]	0	Alert that indicates that a <b>bat_missing_fault</b> has been detected. This alert bit is cleared by writing it back to 0 with the remaining bits in this register set to 1s. It can also be cleared by clearing <b>en_bat_missing_fault_alert</b> .

## REGISTER DESCRIPTIONS

Symbol Name	Command Code	Access	Bit Range	Default	Description
bat_short_fault_alert			[0]	0	Alert that indicates that a <b>bat_short_fault</b> has been detected. This alert bit is cleared by writing it back to 0 with the remaining bits in this register set to 1s. It can also be cleared by clearing <b>en_bat_short_fault_alert</b> .
<b>CHARGE_STATUS_ALERTS_REG</b>	0x38	R	[5:0]	0	Alerts that <b>charge_status</b> indicators have occurred. Individual bits are enabled by <b>EN_CHARGE_STATUS_ALERTS_REG</b> . Writing 0 to any bit clears that alert. Once set, alert bits remain high until cleared or disabled.
ilim_reg_active_alert			[5]	0	Alert that indicates that <b>charge_status</b> is <b>ilim_reg_active</b> . This alert bit is cleared by writing it back to 0 with the remaining bits in this register set to 1s. It can also be cleared by clearing <b>en_ilim_reg_active_alert</b> .
thermal_reg_active_alert			[4]	0	Alert that indicates that <b>charge_status</b> is <b>thermal_reg_active</b> . This alert bit is cleared by writing it back to 0 with the remaining bits in this register set to 1s. It can also be cleared by clearing <b>en_thermal_reg_active_alert</b> .
vin_uvcl_active_alert			[3]	0	Alert that indicates that <b>charge_status</b> is <b>vin_uvcl_active</b> . This alert bit is cleared by writing it back to 0 with the remaining bits in this register set to 1s. It can also be cleared by clearing <b>en_vin_uvcl_active_alert</b> .
iin_limit_active_alert			[2]	0	Alert that indicates that <b>charge_status</b> is <b>iin_limit_active</b> . This alert bit is cleared by writing it back to 0 with the remaining bits in this register set to 1s. It can also be cleared by clearing <b>en_iin_limit_active_alert</b> .
constant_current_alert			[1]	0	Alert that indicates that <b>charge_status</b> is <b>constant_current</b> . This alert bit is cleared by writing it back to 0 with the remaining bits in this register set to 1s. It can also be cleared by clearing <b>en_constant_current_alert</b> .
constant_voltage_alert			[0]	0	Alert that indicates that <b>charge_status</b> is <b>constant_voltage</b> . This alert bit is cleared by writing it back to 0 with the remaining bits in this register set to 1s. It can also be cleared by clearing <b>en_constant_voltage_alert</b> .
<b>SYSTEM_STATUS_REG</b>	0x39	R	[8:0]	N/A	Real time system status indicator bits
en_chg			[8]	N/A	Indicates that the battery charger is active.
cell_count_err			[7]	N/A	<b>cell_count_err</b> always indicates true when telemetry is not enabled such as when the charger is not enabled.
no_rt			[5]	N/A	Indicates that no frequency setting resistor is detected on the RT pin. The RT pin impedance detection circuit will typically indicate a missing RT resistor for values above 1.4M $\Omega$ . <b>no_rt</b> always indicates true when the battery charger is not enabled such as when there is no input power available.
thermal_shutdown			[4]	N/A	Indicates that the LTC4162 is in thermal shutdown protection due to an excessively high die temperature (typically 150°C).
vin_ovlo			[3]	N/A	Indicates that input voltage shutdown protection is active due to an input voltage above its protection shut-down threshold of approximately 38.6V.
vin_gt_vbat			[2]	N/A	Indicates that the VIN pin voltage is sufficiently above the battery voltage to begin a charge cycle (typically +150mV).
vin_gt_4p2v			[1]	N/A	Indicates that the VIN pin voltage is at least greater than the switching regulator under-voltage lockout level (4.2V typical).
intvcc_gt_2p8v			[0]	N/A	Indicates that the INTVCC pin voltage is greater than the telemetry system lockout level (2.8V typical).
<b>vbat</b>	0x3A	R	[15:0]	0	Signed number that indicates the A/D measurement for the per-cell battery voltage. The value is based on the A/D scaling factor for the battery voltage measurement which is <b>cell_count</b> $\times$ 192.4 $\mu$ V/LSB at the BATSENS+ pin.
<b>vin</b>	0x3B	R	[15:0]	0	Signed number that indicates the A/D measurement for the input voltage. The value is based on the A/D scaling factor for the input voltage measurement which is 1.649mV/LSB.
<b>vout</b>	0x3C	R	[15:0]	0	Signed number that indicates the A/D measurement for the <b>vout</b> voltage. The value is based on the A/D scaling factor for the output voltage measurement which is 1.653mV/LSB.

## REGISTER DESCRIPTIONS

Symbol Name	Command Code	Access	Bit Range	Default	Description
<b>ibat</b>	0x3D	R	[15:0]	0	Signed number that indicates the A/D measurement for the battery current. The value is based on the A/D scaling factor for the charge current measurement (VCSP - VCSN) which is 1.466 $\mu$ V/RSNSB amperes/LSB. If the charger is not enabled the value represents drain on the battery and will be negative.
<b>iin</b>	0x3E	R	[15:0]	0	Signed number that indicates the A/D measurement for the input current (VCLP - VCLN). The value is based on the A/D scaling factor for the input current measurement which is 1.466 $\mu$ V / RSNSI amperes/LSB.
<b>die_temp</b>	0x3F	R	[15:0]	0	Signed number that indicates the A/D measurement for the die temperature. The value can be calculated from the A/D reading in $^{\circ}$ C as TDIE( $^{\circ}$ C) = <b>die_temp</b> $\times$ 0.0215 $^{\circ}$ C/LSB - 264.4 $^{\circ}$ C.
<b>thermistor_voltage</b>	0x40	R	[15:0]	0	Signed number that indicates the A/D measurement for the NTC pin voltage. The thermistor value can be determined by the expression $R_{NTC} = R_{NTCBIAS} \times \text{thermistor\_voltage} / (21829 - \text{thermistor\_voltage})$ . Recall that the thermistor has a negative temperature coefficient so higher temperatures make lower <b>thermistor_voltage</b> readings and vice-versa. Enum: <b>open_thermistor</b> = 21684
<b>bsr</b>	0x41	R	[15:0]	0	Indicates the A/D measurement for the per-cell battery resistance. The battery resistance is relative to the battery charge current setting resistor, RSNSB, and can be computed in $\Omega$ from $\text{cell\_count} \times \text{bsr} \times \text{RSNSB} / 500$ . If the charge current, <b>ibat</b> , is below <b>icharge_over_10</b> , <b>bsr_questionable</b> will be set.
<b>jeita_region</b>	0x42	R	[2:0]	0	Indicates the LTC4162 JEITA battery temperature region containing the <b>thermistor_voltage</b> . The temperature region consists of the values bounded by the transition temperatures <b>jeita_t(R-1)</b> and <b>jeita_t(R)</b> . Recall that the thermistor has a negative temperature coefficient so higher temperatures make lower <b>thermistor_voltage</b> readings and vice-versa. JEITA temperature-controlled charging is active only when <b>en_jeita</b> is at its default value of 1. JEITA regions <b>R7</b> ( <b>jeita_region</b> = 7) and <b>R1</b> ( <b>jeita_region</b> = 1) indicate that the <b>thermistor_voltage</b> (battery temperature) is out of range for charging and therefore charging is paused ( <b>ntc_pause</b> ). The transition temperatures are set by <b>jeita_t1</b> through <b>jeita_t6</b> . Enums: <b>R7</b> = 7, <b>R6</b> = 6, <b>R5</b> = 5, <b>R4</b> = 4, <b>R3</b> = 3, <b>R2</b> = 2, <b>R1</b> = 1
<b>CHEM_CELLS_REG</b>	0x43	R	[11:0]	0	Programmed battery chemistry
<b>chem</b>			[11:8]	0	Indicates the chemistry of the battery being charged. For additional safety, application software can test this value to ensure that the correct version of the LTC4162 (LTC4162-L, LTC4162-F or LTC4162-S) is populated on the circuit board. Enums: <b>LTC4162_LAD</b> = 0, <b>LTC4162_L42</b> = 1, <b>LTC4162_L41</b> = 2, <b>LTC4162_L40</b> = 3, <b>LTC4162_FAD</b> = 4, <b>LTC4162_FFS</b> = 5, <b>LTC4162_FST</b> = 6, <b>LTC4162_SST</b> = 8, <b>LTC4162_SAD</b> = 9



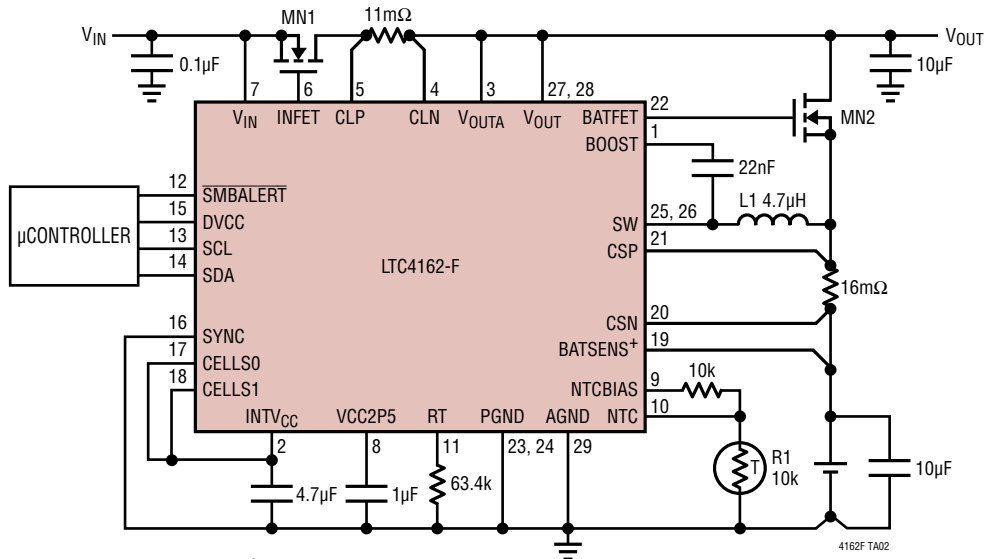
## REGISTER DESCRIPTIONS

Symbol Name	Command Code	Access	Bit Range	Default	Description
cell_count			[3:0]	0	Indicates the cell count value detected by the CELLS0 and CELLS1 pin strapping. <a href="#">cell_count</a> always indicates 0 when the battery charger is not enabled such as when there is no input power available. Enum: <a href="#">Unknown</a> = 0
icharge_dac	0x44	R	[4:0]	0	Indicates the actual charge current setting applied to the charge current digital to analog converter. <a href="#">icharge_dac</a> is ramped up/down to implement digital soft-start/stop. The LTC4162 sets the value of <a href="#">icharge_dac</a> based on <a href="#">charger_state</a> , <a href="#">thermistor_voltage</a> , and charger settings including <a href="#">charge_current_setting</a> , <a href="#">icharge_jeita_2</a> through <a href="#">icharge_jeita_6</a> , <a href="#">jeita_t1</a> through <a href="#">jeita_t6</a> and <a href="#">en_jeita</a> . Recall that the charge current is regulated by controlling the voltage across an external current sense resistor RSNSB. The servo voltage is given by $(\text{icharge\_dac} + 1) \times 1\text{mV}$ . The charge current servo level is thus given by $(\text{icharge\_dac} + 1) \times 1\text{mV}/\text{RSNSB}$ .
vcharge_dac	0x45	R	[4:0]	0	This is the actual battery voltage setting applied to the charge voltage digital to analog converter. The LTC4162 sets the value of <a href="#">vcharge_dac</a> based on <a href="#">charger_state</a> , <a href="#">thermistor_voltage</a> , and charger settings including <a href="#">vcharge_setting</a> , <a href="#">vcharge_jeita_2</a> through <a href="#">vcharge_jeita_6</a> , <a href="#">jeita_t1</a> through <a href="#">jeita_t6</a> , <a href="#">thermistor_voltage</a> , <a href="#">vabsorb_delta</a> and <a href="#">en_jeita</a> . The charge voltage setting can be computed from $\text{cell\_count} \times (\text{vcharge\_setting} \times 12.5\text{mV} + 3.4125\text{V})$ where <a href="#">vcharge_setting</a> also ranges from 0 to 31 (3.8V max).
iin_limit_dac	0x46	R	[5:0]	0	Indicates the actual input current limit. The <a href="#">iin_limit_dac</a> will follow the value programmed in <a href="#">iin_limit_target</a> . The input current will be regulated to a maximum value given by $(\text{iin\_limit\_dac} + 1) \times 500\mu\text{V} / \text{RSNSI}$ .
vbat_filt	0x47	R	[15:0]	0	Signed number that is a digitally filtered version of the A/D measurement of <a href="#">vbat</a> . The value is based on the A/D scaling factor for the battery voltage measurement which is $\text{cell\_count} \times 192.4\mu\text{V}/\text{LSB}$ at the BATSENS+ pin.
bsr_charge_current	0x48	R	[15:0]	0	Signed number that is the battery charge current that existed during the battery series resistance measurement. The value is based on the A/D value, <a href="#">ibat</a> , which has a scaling factor of $1.466\mu\text{V} / \text{RSNSB}$ amperes/LSB. If the battery series resistance ( <a href="#">bsr</a> ) test runs with <a href="#">ibat</a> values less than <a href="#">icharge_over_10</a> , the accuracy of the test is questionable due to low signal level and <a href="#">bsr_questionable</a> will set. Rerunning the battery series resistance test earlier in the charge cycle with higher <a href="#">ibat</a> , and therefore higher <a href="#">bsr_charge_current</a> , will give the most accurate result. Enum: <a href="#">icharge_over_10</a> = 2184
TELEMETRY_STATUS_REG	0x4A	R	[1:0]	0	Telemetry system status register
bsr_questionable			[1]	0	Indicates that the battery series resistance measurement is questionable due to low signal, specifically that <a href="#">ibat</a> was less than <a href="#">icharge_over_10</a> , when the last battery series resistance ( <a href="#">bsr</a> ) measurement was taken. <a href="#">bsr_charge_current</a> contains the <a href="#">ibat</a> A/D value present when the battery series resistance measurement was made.
telemetry_valid			[0]	0	Indicates that the telemetry system autozero amplifiers have had sufficient time, approximately 12ms, to null their offsets. Battery charging is disabled until the telemetry system warm up time has passed.
input_undervoltage_dac	0x4B	R	[7:0]	0	Input undervoltage regulation digital to analog converter value. The regulation voltage is given by $(\text{input\_undervoltage\_dac} + 1) \times 140.625\text{mV}$ . If enabled, the MPPT algorithm will directly manipulate this value. Otherwise it will follow <a href="#">input_undervoltage_setting</a> .

Revision: 1773 Date: 2018-05-09 10:26:00 -0400 (Wed, 09 May 2018)

## TYPICAL APPLICATIONS

### 1-Cell USB Power Delivery Charger with PowerPath

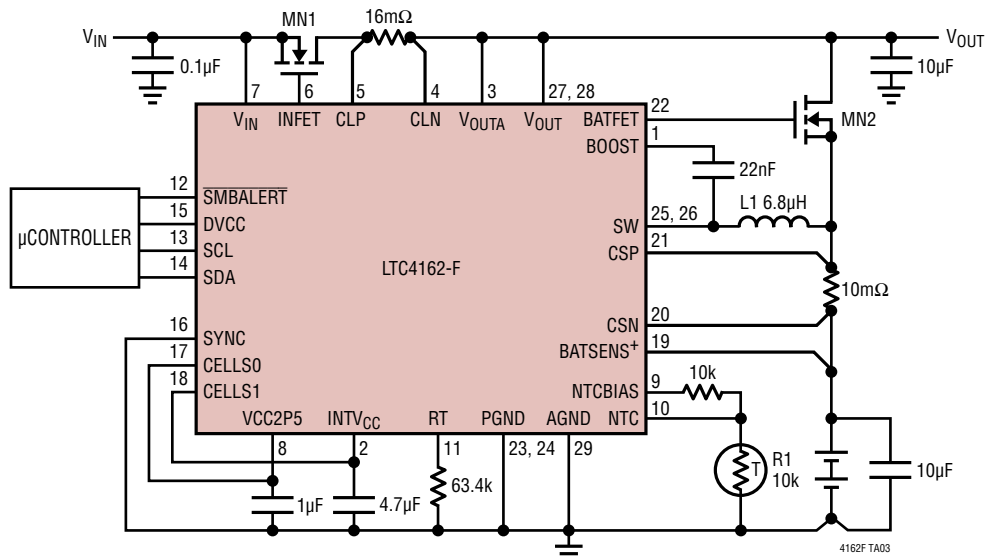


MN1, MN2: FDMC8327L  
 R1: NTCS0402E3103FLT  
 L1: XAL5030-472MEC

4162F TA02

TYPICAL APPLICATIONS

9V to 35V 2-Cell 3.2A Charger with PowerPath and 2A Input Limit



MN1, MN2: FDMC8327L  
 R1: NTC50402E3103FLT  
 L1: XAL6060-682MEC

4162F TA03



## REVISION HISTORY

REV	DATE	DESCRIPTION	PAGE NUMBER
A	10/18	Changed Parameter and Conditions for Symbol $V_{OL12C}$ Changed 3.5 $\mu$ A to 2.8 $\mu$ A in Low Power Ship Mode section	5 28