

## FEATURES

- Small Footprint
- 33mΩ MOSFET with R<sub>SENSE</sub>
- Available in Preset 12V and 5V Versions
- Adjustable, 10% Accurate Current Limit
- Current and Temperature Monitor Outputs
- Overtemperature Protection
- Adjustable Current Limit Timer Before Fault
- Power Good and Fault Outputs
- Adjustable Inrush Current Control
- Available in 16-Lead 5mm × 3mm DFN Package

## APPLICATIONS

- RAID Systems
- Server I/O Cards
- Industrial

## DESCRIPTION

The LTC<sup>®</sup>4219 is an integrated solution for Hot Swap applications that allows a board to be safely inserted and removed from a live backplane. The part integrates a Hot Swap controller, power MOSFET and current sense resistor in a single package for small form factor applications.

The LTC4219 provides separate inrush current control and a 10% accurate 5.6A current limit with foldback current limiting. The current limit threshold can be adjusted dynamically using an external pin. Additional features include a current monitor output that amplifies the sense resistor voltage for ground referenced current sensing and a MOSFET temperature monitor output. Thermal limit and power good monitoring are also provided. The power good detection level and foldback current limit profile are internally preset for 5V (LTC4219-5) and 12V (LTC4219-12) applications.

LT, LT, LTC, LTM, Linear Technology and the Linear logo are registered trademarks of Linear Technology Corporation. All other trademarks are the property of their respective owners.

## TYPICAL APPLICATION

12V, 5A Card Resident Application

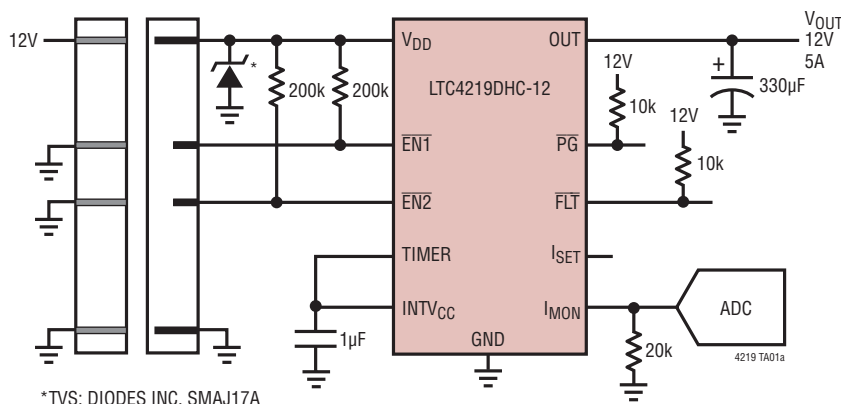

Power-Up Waveforms

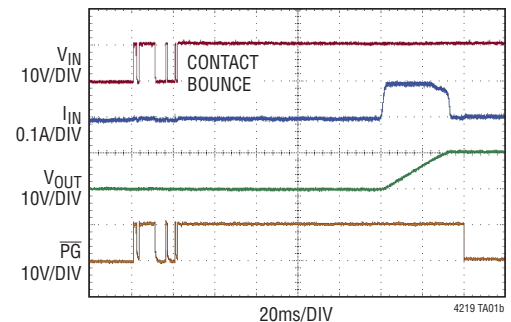

# LTC4219

## ABSOLUTE MAXIMUM RATINGS

(Notes 1, 2)

Supply Voltage ( $V_{DD}$ )	-0.3V to 28V
Input Voltages	
FB, $\overline{EN1}$ , $\overline{EN2}$	-0.3V to 12V
TIMER	-0.3V to 3.5V
SENSE	$V_{DD} - 10V$ or -0.3V to $V_{DD}$
Output Voltages	
$I_{SET}$ , $I_{MON}$	-0.3V to 3V
PG, FLT	-0.3V to 35V
OUT	-0.3V to $V_{DD} + 0.3V$
INTV <sub>CC</sub>	-0.3V to 3.5V
GATE (Note 3)	-0.3V to 33V
Operating Ambient Temperature Range	
LTC4219C	0°C to 70°C
LTC4219I	-40°C to 85°C
Junction Temperature (Notes 4, 5)	125°C
Storage Temperature Range	-65°C to 150°C

## PIN CONFIGURATION

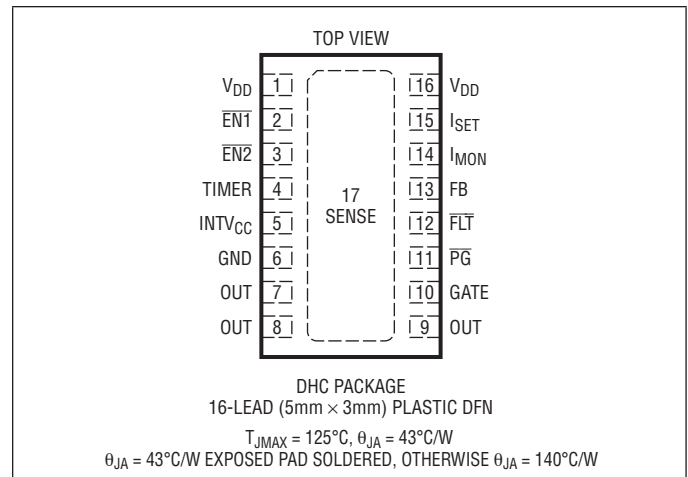

## ORDER INFORMATION

LEAD FREE FINISH	TAPE AND REEL	PART MARKING*	PACKAGE DESCRIPTION	TEMPERATURE RANGE
LTC4219CDHC-12#PBF	LTC4219CDHC-12#TRPBF	421912	16-Lead (5mm × 3mm) Plastic DFN	0°C to 70°C
LTC4219IDHC-12#PBF	LTC4219IDHC-12#TRPBF	421912	16-Lead (5mm × 3mm) Plastic DFN	-40°C to 85°C
LTC4219CDHC-5#PBF	LTC4219CDHC-5#TRPBF	42195	16-Lead (5mm × 3mm) Plastic DFN	0°C to 70°C
LTC4219IDHC-5#PBF	LTC4219IDHC-5#TRPBF	42195	16-Lead (5mm × 3mm) Plastic DFN	-40°C to 85°C

Consult LTC Marketing for parts specified with wider operating temperature ranges. \*The temperature grade is identified by a label on the shipping container.

For more information on lead free part marking, go to: <http://www.linear.com/leadfree/>

For more information on tape and reel specifications, go to: <http://www.linear.com/tapeandreeel/>. Some packages are available in 500 unit reels through designated sales channels with #TRMPBF suffix.

## ELECTRICAL CHARACTERISTICS

The ● denotes the specifications which apply over the full operating temperature range, otherwise specifications are at  $T_A = 25^\circ\text{C}$ .  $V_{DD} = 12\text{V}$  unless otherwise noted.

SYMBOL	PARAMETER	CONDITIONS		MIN	TYP	MAX	UNITS
<b>DC Characteristics</b>							
$V_{DD}$	Input Supply Range		●	2.9		15	V
$I_{DD}$	Input Supply Current	MOSFET On, No Load	●		1.6	3	mA
$V_{DD(UVL)}$	Input Supply Undervoltage Lockout	$V_{DD}$ Rising	●	2.65	2.73	2.85	V
$V_{OUT(PGTH)}$	Output Power Good Threshold	LTC4219-12, $V_{OUT}$ Rising	●	10.2	10.5	10.8	V
		LTC4219-5, $V_{OUT}$ Rising	●	4.2	4.35	4.5	V
$\Delta V_{OUT(PGHYST)}$	Output Power Good Hysteresis	LTC4219-12	●	127	170	213	mV
		LTC4219-5	●	53	71	89	mV
$I_{OUT}$	OUT Leakage Current	$V_{OUT} = V_{GATE} = 0\text{V}$ , $V_{DD} = 15\text{V}$	●		0	$\pm 150$	$\mu\text{A}$
		$V_{OUT} = V_{GATE} = 12\text{V}$ , LTC4219-12	●	50	70	90	$\mu\text{A}$
		$V_{OUT} = V_{GATE} = 5\text{V}$ , LTC4219-5	●	26	36	46.5	$\mu\text{A}$
$dV_{GATE}/dt$	GATE Pin Turn-On Ramp Rate		●	0.15	0.3	0.55	V/ms
$R_{ON}$	MOSFET + Sense Resistor On Resistance		●	15	33	50	$\text{m}\Omega$
$I_{LIM(TH)}$	Current Limit Threshold	$V_{FB} = 1.23\text{V}$	●	5.0	5.6	6.1	A
		$V_{FB} = 0\text{V}$	●	1.2	1.5	1.8	A
		$V_{FB} = 1.23\text{V}$ , $R_{SET} = 20\text{k}\Omega$	●	2.6	2.9	3.3	A
<b>Inputs</b>							
$I_{IN}$	$\overline{EN1}$ , $\overline{EN2}$ Input Current	$V_{PIN} = 1.2\text{V}$	●		0	$\pm 1$	$\mu\text{A}$
$R_{FB}$	FB Input Resistance	LTC4219-12	●	13	18	23	$\text{k}\Omega$
		LTC4219-5	●	20	29	37	$\text{k}\Omega$
$V_{TH}$	$\overline{EN1}$ , $\overline{EN2}$ , FB Threshold Voltage	$V_{PIN}$ Rising	●	1.21	1.235	1.26	V
$\Delta V_{EN(HYST)}$	$\overline{EN1}$ , $\overline{EN2}$ Hysteresis		●	50	80	110	mV
$\Delta V_{FB(HYST)}$	FB Power Good Hysteresis		●	10	20	30	mV
$R_{ISET}$	$I_{SET}$ Internal Resistor		●	19	20	21	$\text{k}\Omega$

## ELECTRICAL CHARACTERISTICS

The ● denotes the specifications which apply over the full operating temperature range, otherwise specifications are at  $T_A = 25^\circ\text{C}$ .  $V_{DD} = 12\text{V}$  unless otherwise noted.

SYMBOL	PARAMETER	CONDITIONS	MIN	TYP	MAX	UNITS
<b>Outputs</b>						
$V_{INTVCC}$	INTV <sub>CC</sub> Output Voltage	$V_{DD} = 5\text{V}, 15\text{V}$ $I_{LOAD} = 0\text{mA}, -10\text{mA}$	● 2.8	3.1	3.2	V
$V_{OL}$	PG, $\overline{\text{FLT}}$ Output Low Voltage	$I_{SINK} = 2\text{mA}$	●	0.4	0.8	V
$I_{OH}$	PG, $\overline{\text{FLT}}$ Input Leakage Current	$V_{PIN} = 30\text{V}$	●	0	$\pm 10$	$\mu\text{A}$
$V_{TIMER(H)}$	TIMER High Threshold	$V_{TIMER}$ Rising	● 1.2	1.235	1.28	V
$V_{TIMER(L)}$	TIMER Low Threshold	$V_{TIMER}$ Falling	● 0.1	0.21	0.3	V
$I_{TIMER(UP)}$	TIMER Pull-Up Current	$V_{TIMER} = 0\text{V}$	● -80	-100	-120	$\mu\text{A}$
$I_{TIMER(DN)}$	TIMER Pull-Down Current	$V_{TIMER} = 1.2\text{V}$	● 1.4	2	2.6	$\mu\text{A}$
$I_{TIMER(RATIO)}$	TIMER Current Ratio $I_{TIMER(DN)}/I_{TIMER(UP)}$		● 1.6	2	2.7	%
$A_{IMON}$	$I_{MON}$ Current Gain	$I_{OUT} = 2.5\text{A}$	● 18.5	20	21.5	$\mu\text{A/A}$
$BW_{IMON}$	$I_{MON}$ Bandwidth			250		kHz
$I_{OFF(IMON)}$	$I_{MON}$ Offset Current	$I_{OUT} = 150\text{mA}$	●	0	$\pm 4.5$	$\mu\text{A}$
$I_{GATE(UP)}$	Gate Pull-Up Current	Gate Drive On, $V_{GATE} = V_{OUT} = 12\text{V}$	● -19	-24	-29	$\mu\text{A}$
$I_{GATE(DN)}$	Gate Pull-Down Current	Gate Drive Off, $V_{GATE} = 18\text{V}, V_{OUT} = 12\text{V}$	● 190	250	400	$\mu\text{A}$
$I_{GATE(FST)}$	Gate Fast Pull-Down Current	Fast Turn Off, $V_{GATE} = 18\text{V}, V_{OUT} = 12\text{V}$		140		mA
<b>AC Characteristics</b>						
$t_{PHL(GATE)}$	Input High ( $\overline{\text{EN1}}, \overline{\text{EN2}}$ ) to Gate Low Propagation Delay	$V_{GATE} < 16.5\text{V}$ Falling	●	8	10	$\mu\text{s}$
$t_{PHL(ILIM)}$	Short Circuit to Gate Low	$V_{FB} = 0$ , Step $I_{SENSE}$ to 6A, $V_{GATE} < 15\text{V}$ Falling	●	1	5	$\mu\text{s}$
$t_{D(ON)}$	Turn-On Delay	Step $V_{\overline{\text{EN1}}}$ and $V_{\overline{\text{EN2}}}$ to 0V, $V_{GATE} > 13\text{V}$	● 50	100	150	ms
$t_{D(Fault)}$	$\overline{\text{EN1}}$ High to Clear Fault Latch Delay			5		$\mu\text{s}$
$t_{D(CB)}$	Circuit Breaker Filter Delay Time (Internal)	$V_{FB} = 0\text{V}$ , Step $I_{SENSE}$ to 3A	● 1.5	2	2.7	ms

**Note 1:** Stresses beyond those listed under Absolute Maximum Ratings may cause permanent damage to the device. Exposure to any Absolute Maximum Rating condition for extended periods may affect device reliability and lifetime.

**Note 2:** All currents into pins are positive, all voltages are referenced to GND unless otherwise specified.

**Note 3:** An internal clamp limits the GATE pin to a maximum of 6.5V above OUT. Driving this pin to voltages beyond the clamp may damage the device.

**Note 4:** This IC includes overtemperature protection that is intended to protect the device during momentary overload conditions. Junction temperature will exceed  $125^\circ\text{C}$  when overtemperature protection is active. Continuous operation above the specified maximum operating junction temperature may impair device reliability.

**Note 5:**  $T_J$  is calculated from the ambient temperature,  $T_A$ , and power dissipation,  $P_D$ , according to the formula:

$$T_J = T_A + (P_D \cdot 43^\circ\text{C/W})$$

**TYPICAL PERFORMANCE CHARACTERISTICS**  $T_A = 25^\circ\text{C}$ ,  $V_{DD} = 12\text{V}$  unless otherwise noted.

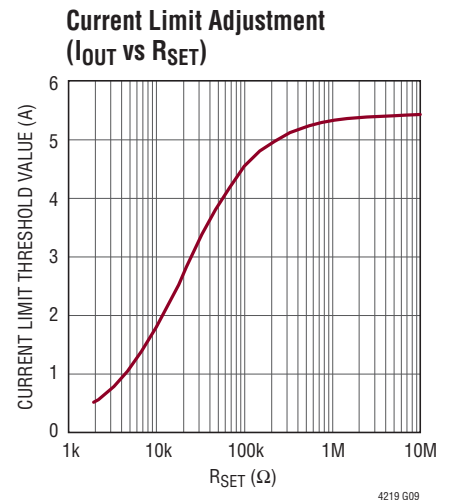
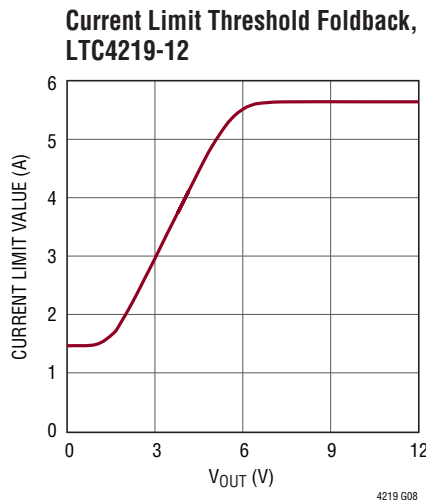
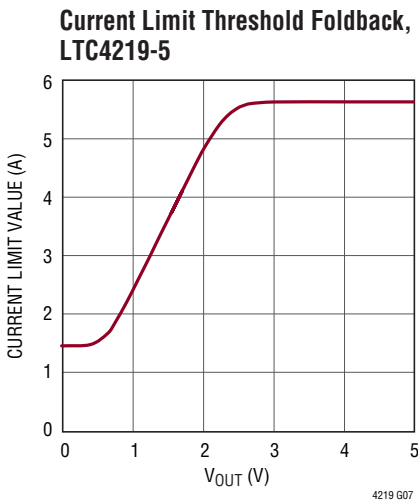
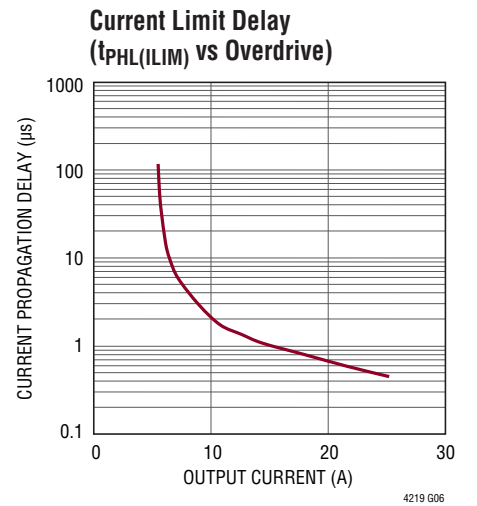
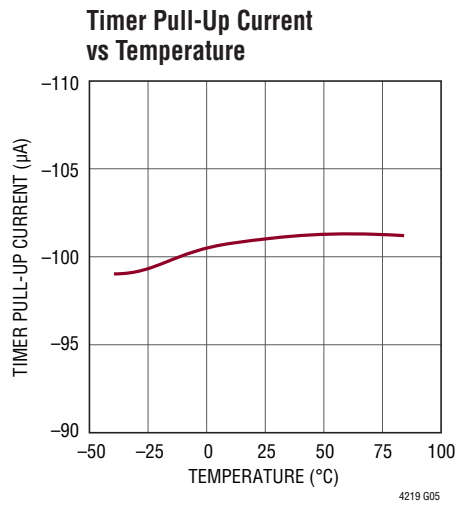
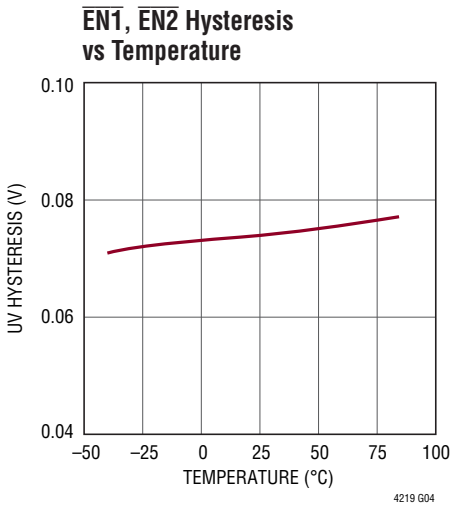
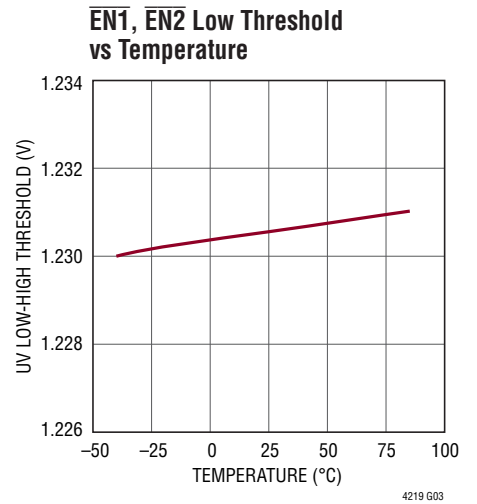
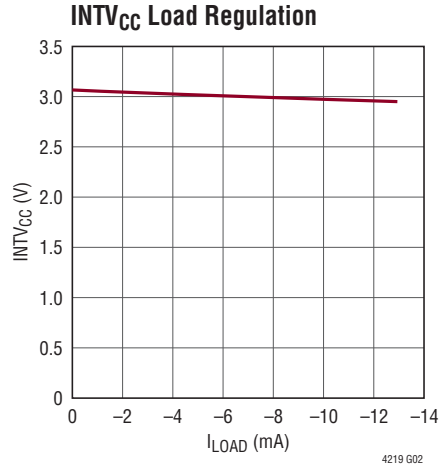
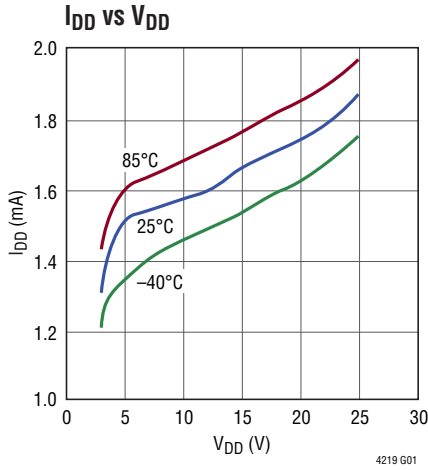

## TYPICAL PERFORMANCE CHARACTERISTICS $T_A = 25^\circ\text{C}$ , $V_{DD} = 12\text{V}$ unless otherwise noted.

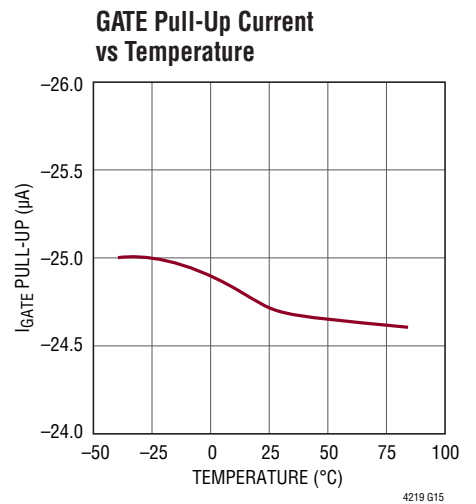
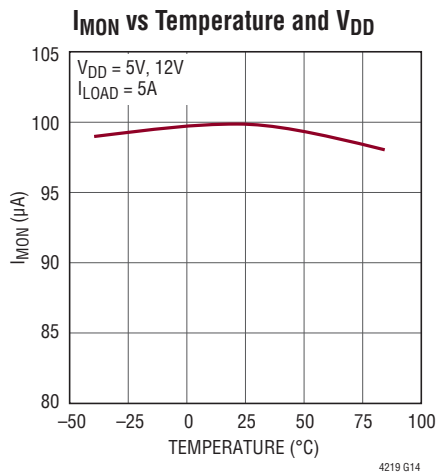
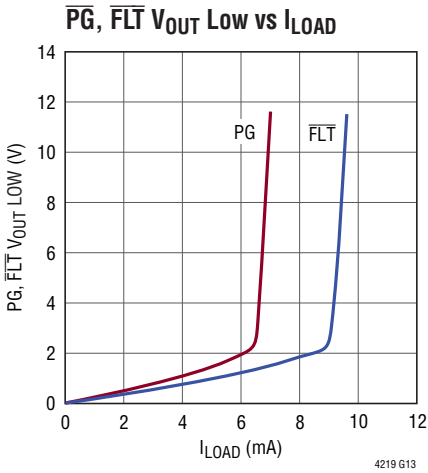
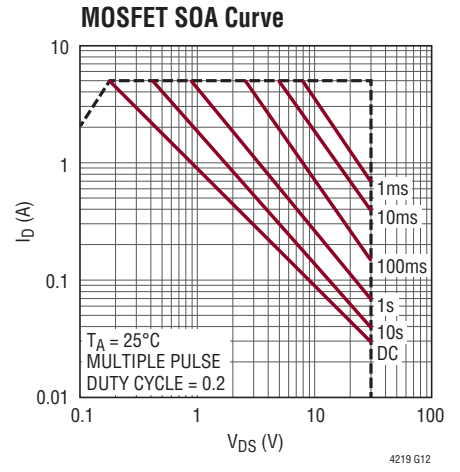
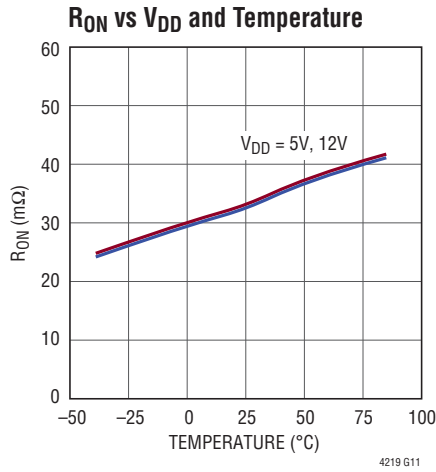
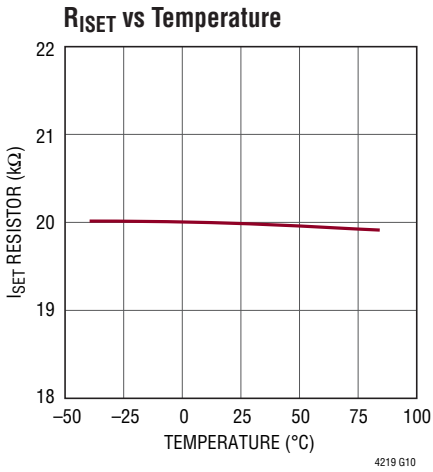

**TYPICAL PERFORMANCE CHARACTERISTICS**  $T_A = 25^\circ\text{C}$ ,  $V_{DD} = 12\text{V}$  unless otherwise noted.

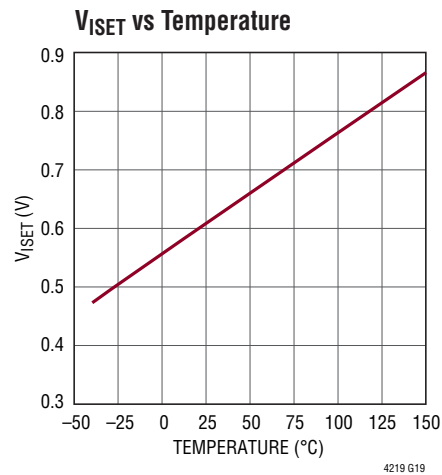
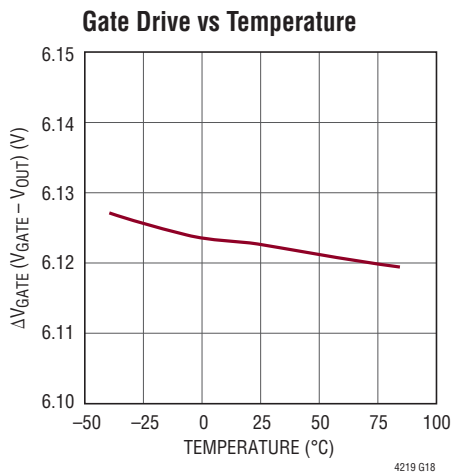
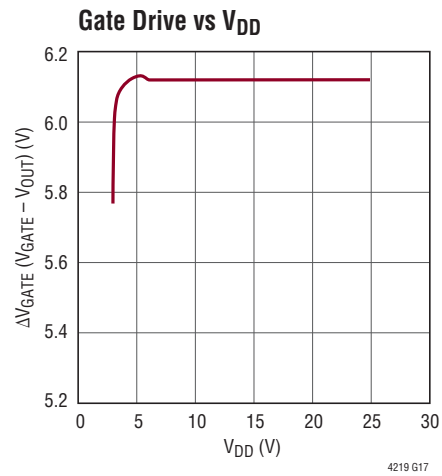
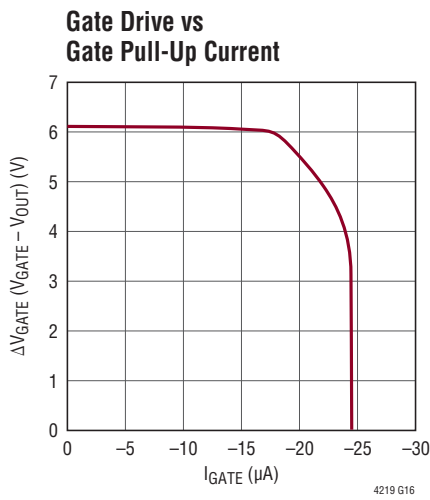

## PIN FUNCTIONS

**$\overline{\text{EN1}}$ :** Inverted Enable 1 Input. Ground this pin to enable the MOSFET to turn on after 100ms debounce delay. If the voltage at this pin rises above 1.235V for longer than 10 $\mu$ s a turn-off command is detected, the overcurrent fault is cleared and the MOSFET gate is discharged with a 250 $\mu$ A current. Bringing this pin below 1.15V and  $\overline{\text{EN2}}$  low for 100ms begins GATE pin ramping.

**$\overline{\text{EN2}}$ :** Inverted Enable 2 Input. Ground this pin to enable the MOSFET to turn on after 100ms debounce delay. If the voltage at this pin rises above 1.235V for longer than 10 $\mu$ s a turn-off command is detected and the MOSFET gate is discharged with a 250 $\mu$ A current. Bringing this pin below 1.15V and  $\overline{\text{EN1}}$  low for 100ms begins GATE pin ramping.

**Exposed Pad:** SENSE.

**FB:** Foldback and Power Good Input. The FB pin is driven from an internal resistive divider from OUT for both the LTC4219-12 and LTC4219-5. These versions preset 12V and 5V foldback and power good levels. If the OUT voltage falls below 2.5V (LTC4219-5) or 6V (LTC4219-12) the current limit is reduced using a foldback profile (see the Typical Performance Characteristics section). If the FB voltage falls below 1.21V the  $\overline{\text{PG}}$  pin will pull high to indicate the power is bad.

**$\overline{\text{FLT}}$ :** Overcurrent Fault Indicator. Open-drain output pulls low when an overcurrent fault has occurred and the circuit breaker trips.

**GATE:** Gate Drive for Internal N-channel MOSFET. An internal 24 $\mu$ A current source charges the gate of the N-channel MOSFET. At start-up the GATE pin ramps up at a 0.3V/ms rate determined by internal circuitry. When either  $\overline{\text{EN1}}$  or  $\overline{\text{EN2}}$  pin goes high, a 250 $\mu$ A pull-down current turns the MOSFET off. During a short-circuit or undervoltage lockout condition, a 140mA pull-down current source between GATE and OUT is activated.

**GND:** Device Ground.

**$I_{\text{MON}}$ :** Current Monitor Output. The current in the internal MOSFET switch is divided by 50,000 and sourced from this pin. Placing a 20k resistor from this pin to GND creates a 0V to 2V voltage swing when current ranges from 0A to 5A.

**$\text{INTV}_{\text{CC}}$ :** Internal 3V Supply Decoupling Output. This pin must have a 1 $\mu$ F or larger bypass capacitor. Overloading this pin can disrupt internal operation.

**$I_{\text{SET}}$ :** Current Limit Adjustment Pin. For a 5.6A current limit value open this pin. This pin is driven by a 20k resistor in series with a voltage source. The pin voltage is used to generate the current limit threshold. The internal 20k resistor ( $R_{\text{ISET}}$ ) and an external resistor ( $R_{\text{SET}}$ ) between  $I_{\text{SET}}$  and ground create an attenuator that lowers the current limit value. Due to circuit tolerance  $R_{\text{SET}}$  should not be less than 2k. In order to match the temperature variation of the sense resistor, the voltage on this pin increases at the same rate as the sense resistance increases. Therefore the voltage at  $I_{\text{SET}}$  pin is proportional to temperature of the MOSFET switch.

**OUT:** Output of Internal MOSFET Switch. Connect this pin directly to the load. An internal resistive divider is connected to this pin to drive the FB pin.

**$\overline{\text{PG}}$ :** Power Good Indicator. Open-drain output releases the  $\overline{\text{PG}}$  pin to go high when the FB pin drops below 1.21V indicating the power is bad. If the FB pin rises above 1.23V and the GATE to OUT voltage exceeds 4.2V, the open-drain output pulls low indicating power is good.

**SENSE:** Current Sense Node and MOSFET Drain. The current limit circuit controls the GATE pin to limit the sense voltage between the  $V_{\text{DD}}$  and SENSE pins to 42mV (5.6A) or less depending on the voltage at the FB pin. The exposed pad on the DHC package is connected to SENSE and must be soldered to an electrically isolated printed circuit board trace to properly transfer the heat out of the package.

**TIMER:** Timer Input. Connect a capacitor between this pin and ground to set a 12ms/ $\mu$ F duration for current limit before the switch is turned off. If the  $\overline{\text{EN1}}$  pin is toggled first high then low while the MOSFET switch is off, the switch will turn on again following a cooldown time of 518ms/ $\mu$ F duration. Tie this pin to  $\text{INTV}_{\text{CC}}$  for a fixed 2ms overcurrent delay.

**$V_{\text{DD}}$ :** Supply Voltage and Current Sense Input. This pin has an undervoltage lockout threshold of 2.73V.





## OPERATION

The Functional Diagram displays the main circuits of the device. The LTC4219 is designed to turn a board's supply voltage on and off in a controlled manner allowing the board to be safely inserted and removed from a live backplane. The LTC4219 includes a 25m $\Omega$  MOSFET and a 7.5m $\Omega$  current sense resistor. During normal operation, the charge pump and gate driver turn on the pass MOSFET's gate to provide power to the load. The inrush current control is accomplished by the INRUSH circuit. This circuit limits the GATE ramp rate to 0.3V/ms and hence controls the voltage ramp rate of the output capacitor.

The current sense (CS) amplifier monitors the load current using the voltage sensed across the current sense resistor. The CS amplifier limits the current in the load by reducing the GATE-to-OUT voltage in an active control loop. It is simple to adjust the current limit threshold using the current limit adjustment (I<sub>SET</sub>) pin. This allows a different threshold during other times such as start-up.

A short circuit on the output to ground causes significant power dissipation during active current limiting. To limit this power, the foldback amplifier reduces the current limit value from 5.6A to 1.5A in a linear manner as the FB pin drops below 0.6V (see the Typical Performance Characteristics section).

If an overcurrent condition persists, the TIMER pin ramps up with a 100 $\mu$ A current source until the pin voltage exceeds 1.235V (comparator TM2). This indicates to the logic that it is time to turn off the pass MOSFET to prevent overheating. At this point the TIMER pin ramps down using the 2 $\mu$ A current source until the voltage drops below 0.21V (Comparator TM1) which tells the logic to start an

internal 100ms timer. After this delay, the pass transistor has cooled and it is safe to turn it on again. It is suitable for many applications to use an internal 2ms overcurrent timer with a 100ms cooldown period. Tying the TIMER pin to INTV<sub>CC</sub> sets this default timing.

The fixed 5V and 12V versions, LTC4219-5 and LTC4219-12, use an internal divider from OUT to drive the FB pin. This divider also sets the foldback current limit profile. The output voltage is monitored using the FB pin and the PG comparator to determine if the power is available for the load. The power good condition is signaled by the  $\overline{\text{PG}}$  pin using an open-drain pull-down transistor.

The Functional Diagram also shows the monitoring blocks of the LTC4219. The two comparators on the left side include the  $\overline{\text{EN1}}$  and  $\overline{\text{EN2}}$  comparators. These comparators determine if the enable inputs are valid prior to turning on the MOSFET. But first the undervoltage lockout circuits UVLO1 and UVLO2 must validate the input supply and the internally generated 3.1V supply (INTV<sub>CC</sub>) and generate the power up initialization to the logic circuits. If the external conditions remain valid for 100ms the MOSFET is allowed to turn on.

Other features include MOSFET current and temperature monitoring. The current monitor (CM) outputs a current proportional to the sense resistor current. This current can drive an external resistor or other circuits for monitoring purposes. A voltage proportional to the MOSFET temperature is output to the I<sub>SET</sub> pin. The MOSFET is protected by a thermal shutdown circuit.

## APPLICATIONS INFORMATION

The typical LTC4219 application is in a high availability system that uses a positive voltage supply to distribute power to individual cards. A complete application circuit is shown in Figure 1. External component selection is discussed in detail in the following sections.

### Turn-On Sequence

Several conditions must be present before the internal pass MOSFET can be turned on. First the supply  $V_{DD}$  must exceed its undervoltage lockout level. Next the internally generated supply  $INTV_{CC}$  must cross its 2.65V undervoltage threshold. This generates a 25 $\mu$ s power-on-reset pulse which clears the fault register and initializes internal latches. Finally, the enable inputs  $\overline{EN1}$  and  $\overline{EN2}$  both must be below the 1.15V threshold. All of these conditions must be satisfied for the duration of 100ms to ensure that any contact bounce during the insertion has ended.

The MOSFET is turned on by charging up the GATE with a charge pump generated 24 $\mu$ A current source whose value is adjusted by shunting a portion of the pull-up current to ground. The charging current is controlled by the INRUSH circuit that maintains a constant slope of GATE voltage versus time (Figure 2). The voltage at the GATE pin rises with a slope of 0.3[V/ms] and the supply inrush current is set at:

$$I_{INRUSH} = C_L \cdot 0.3[V/ms]$$

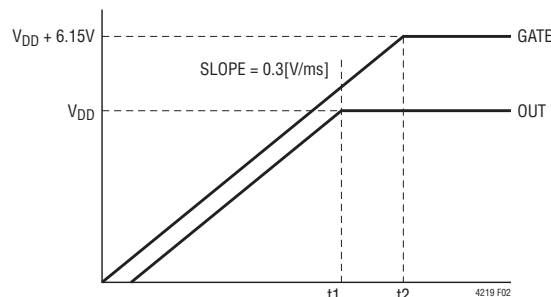
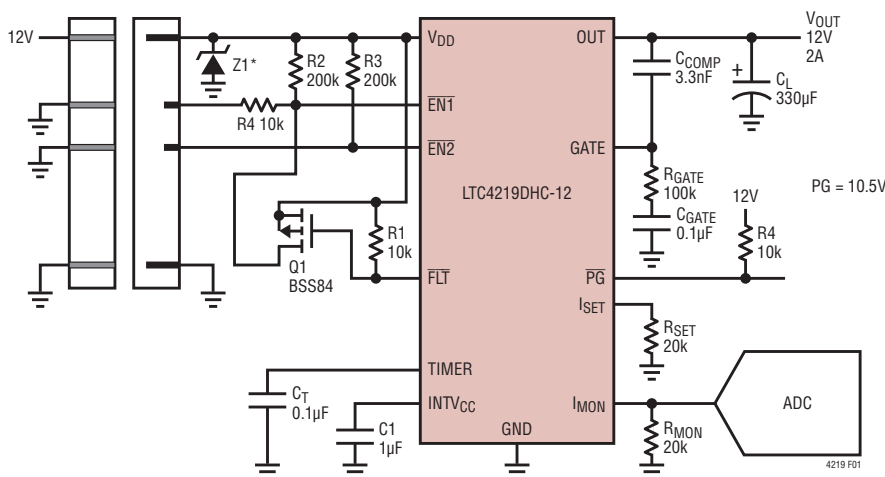

Figure 2. Supply Turn-On

This gate slope is designed to charge up a 1000 $\mu$ F capacitor to 12V in 40ms, with an inrush current of 300mA. This allows the inrush current to stay under the current limit threshold (1.5A) for capacitors less than 1000 $\mu$ F. Included in the Typical Performance Characteristics section is a graph of the Safe Operating Area for the MOSFET. It is evident from this graph that the power dissipation at 12V, 300mA for 40ms is in the safe region.

Adding the  $R_{GATE}$ ,  $C_{GATE}$  and  $C_{COMP}$  network on the GATE pin will lower the inrush current below the default value set by the inrush circuit. The GATE is then charged with a 24 $\mu$ A current source. The voltage at the GATE pin rises with a slope equal to  $24\mu A / C_{GATE}$  and the supply inrush current is set at:

$$I_{INRUSH} = \frac{C_L}{C_{GATE}} \cdot 24\mu A$$



\*TVS Z1: DIODES INC. SMAJ17A

Figure 1. 2A, 12V Card Resident Application with Auto-Retry

## APPLICATIONS INFORMATION

When the GATE voltage reaches the MOSFET threshold voltage, the switch begins to turn on and the OUT voltage follows the GATE voltage as it increases. Once OUT reaches  $V_{DD}$ , the GATE will ramp up until clamped by the 6.15V Zener between GATE and OUT.

As the OUT voltage rises, so will the FB pin which is monitoring it. Once the FB pin crosses its 1.235V threshold and the GATE to OUT voltage exceeds 4.2V, the  $\overline{PG}$  pin pulls low indicating that the power is good.

### Parasitic MOSFET Oscillation

When the N-channel MOSFET ramps up the output during power-up it operates as a source follower. The source follower configuration may self-oscillate in the range of 25kHz to 300kHz when the load capacitance is less than 10 $\mu$ F, especially if the wiring inductance from the supply to the  $V_{DD}$  pin is greater than 3 $\mu$ H. The possibility of oscillation will increase as the load current (during power-up) increases. There are two ways to prevent this type of oscillation. The simplest way is to avoid load capacitances below 10 $\mu$ F. For wiring inductance larger than 20 $\mu$ H, the minimum load capacitance may extend to 100 $\mu$ F. A second choice is to connect an external gate capacitor  $C_P > 1.5$ nF as shown in Figure 3.

### Turn-Off Sequence

The switch can be turned off by a variety of conditions. A normal turn-off is initiated by either the  $\overline{EN1}$  or  $\overline{EN2}$  pins going above their 1.235V threshold. Additionally, several fault conditions will turn off the switch. These include overcurrent circuit breaker (SENSE pin) or overtemperature. Normally the switch is turned off with a 250 $\mu$ A current pulling down the GATE pin to ground. With the switch turned off, the OUT voltage drops which pulls the FB pin below its threshold.  $\overline{PG}$  then goes high to indicate output power is no longer good.

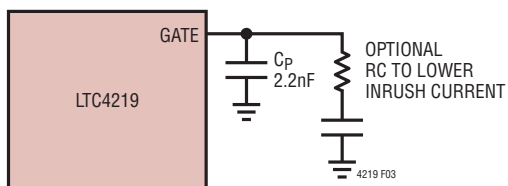

Figure 3. Compensation for Small  $C_{LOAD}$

If  $V_{DD}$  drops below 2.65V for greater than 5 $\mu$ s or  $INTV_{CC}$  drops below 2.5V for greater than 1 $\mu$ s, a fast shutdown of the switch is initiated. The GATE is pulled down with a 140mA current to the OUT pin.

### Overcurrent Fault

The LTC4219 features an adjustable current limit with foldback that protects against short circuits and excessive load current. To prevent excessive power dissipation in the switch during active current limit, the available current is reduced as a function of the output voltage sensed by the FB pin. A graph in the Typical Performance Characteristics curves shows the current limit versus FB voltage.

An overcurrent fault occurs when the current limit circuitry has been engaged for longer than the time-out delay set by the TIMER. Current limiting begins when the MOSFET current reaches 1.5A to 5.6A (depending on the foldback). The GATE pin is then brought down with a 140mA GATE-to-OUT current. The voltage on the GATE is regulated in order to limit the current to less than 5.6A. At this point, a circuit breaker time delay starts by charging the external timing capacitor with a 100 $\mu$ A pull-up current from the TIMER pin. If the TIMER pin reaches its 1.235V threshold, the internal switch turns off (with a 250 $\mu$ A current from GATE to ground). Included in the Typical Performance Characteristics curves is a graph of the Safe Operating Area for the MOSFET. From this graph one can determine the MOSFET's maximum time in current limit for a given output power.

Tying the TIMER pin to  $INTV_{CC}$  will force the part to use the internally generated (circuit breaker) delay of 2ms. In either case the  $\overline{FLT}$  pin is pulled low to indicate an overcurrent fault has turned off the pass MOSFET. For a given circuit breaker time delay, the equation for setting the timing capacitor's value is as follows:

$$C_T = t_{CB} \cdot 0.083 [\mu\text{F/ms}]$$

After the switch is turned off, the TIMER pin begins discharging the timing capacitor with a 2 $\mu$ A pull-down current. When the TIMER pin reaches its 0.21V threshold, an internal 100ms timer is started. After the 100ms delay, the switch is allowed to turn on again if the overcurrent fault latch has been cleared. Bringing the  $\overline{EN1}$  pin above

## APPLICATIONS INFORMATION

1.235V for a minimum of 5 $\mu$ s and then low will clear the fault latch. If the TIMER pin is tied to INTV<sub>CC</sub> then the switch is allowed to turn on again (after an internal 100ms delay), if the overcurrent fault latch is cleared.

Tying the P-channel MOSFET Q1 to the  $\overline{\text{EN1}}$  pin allows the part to self-clear the fault and turn the MOSFET on as soon as the TIMER pin has ramped below 0.21V. In the auto-retry mode the LTC4219 repeatedly tries to turn on after an overcurrent at a period determined by the capacitor on the TIMER pin. The auto-retry mode also functions when the TIMER pin is tied to INTV<sub>CC</sub>.

The waveform in Figure 4 shows how the output latches off following a short-circuit. The current in the MOSFET is 1.4A as the timer ramps up.

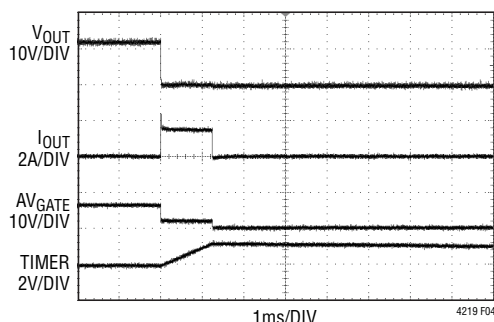

Figure 4. Short-Circuit Waveform

### Current Limit Adjustment

The default value of the active current limit is 5.6A. The current limit threshold can be adjusted lower by placing a resistor between the I<sub>SET</sub> pin and ground. As shown in the Functional Block Diagram the voltage at the I<sub>SET</sub> pin (via the clamp circuit) sets the CS amplifier's built-in offset voltage. This offset voltage directly determines the active current limit value. With the I<sub>SET</sub> pin open, the voltage at the I<sub>SET</sub> pin is determined by a positive temperature coefficient reference. This voltage is set to 0.618V at room temperature which corresponds to a 5.6A current limit at room temperature.

An external resistor R<sub>SET</sub> placed between the I<sub>SET</sub> pin and ground forms a resistive divider with the internal 20k R<sub>ISET</sub> sourcing resistor. The divider acts to lower the voltage at the I<sub>SET</sub> pin and therefore lower the current limit threshold.

The overall current limit threshold precision is reduced to  $\pm 12\%$  when using a 20k resistor to halve the threshold.

Using a switch (connected to ground) in series with R<sub>SET</sub> allows the active current limit to change only when the switch is closed. This feature can be used to program a reduced running current while the maximum available current limit is used at startup.

### Monitor MOSFET Temperature

The voltage at the I<sub>SET</sub> pin increases linearly with increasing temperature. The temperature profile of the I<sub>SET</sub> pin is shown in the Typical Performance Characteristics section. Using a comparator or ADC to measure the I<sub>SET</sub> voltage provides an indicator of the MOSFET temperature.

The I<sub>SET</sub> voltage follows the formula:

$$V_{\text{ISET}} = \frac{R_{\text{SET}}}{R_{\text{SET}} + R_{\text{ISET}}} \cdot (T + 273^{\circ}\text{C}) \cdot 2.093[\text{mV}/^{\circ}\text{C}]$$

The MOSFET temperature is calculated using R<sub>ISET</sub> of 20k.

$$T = \frac{(R_{\text{SET}} + 20\text{k}) \cdot V_{\text{ISET}}}{R_{\text{SET}} \cdot 2.093[\text{mV}/^{\circ}\text{C}]} - 273^{\circ}\text{C}$$

when R<sub>SET</sub> is not present, T becomes:

$$T = \frac{V_{\text{ISET}}}{2.093[\text{mV}/^{\circ}\text{C}]} - 273^{\circ}\text{C}$$

There is an overtemperature circuit in the LTC4219 that monitors an internal voltage similar to the I<sub>SET</sub> pin voltage. When the die temperature exceeds 145°C the circuit turns off the MOSFET until the temperature drops to 125°C.

### Monitor MOSFET Current

The current in the MOSFET passes through an internal 7.5m $\Omega$  sense resistor. The voltage on the sense resistor is converted to a current that is sourced out of the I<sub>MON</sub> pin. The gain of I<sub>SENSE</sub> amplifier is 20 $\mu$ A/A referenced from the MOSFET current. This output current can be converted to a voltage using an external resistor to drive a comparator or ADC. The voltage compliance for the I<sub>MON</sub> pin is from 0V to INTV<sub>CC</sub> - 0.7V.

## APPLICATIONS INFORMATION

A microcontroller with a built-in comparator can build a simple integrating single-slope ADC by resetting a capacitor that is charged with this current. When the capacitor voltage trips the comparator and the capacitor is reset, a timer is started. The time between resets will indicate the MOSFET current.

### Power Good Indication

In addition to setting the foldback current limit threshold, the FB pin is used to determine a power good condition. The LTC4219-12 and LTC4219-5 use an internal resistive divider on the OUT pin to drive the FB pin. On the LTC4219-12, the PG comparator indicates logic high when OUT pin rises above 10.5V. If the OUT pin subsequently falls below 10.3V, the comparator toggles low. On the LTC4219-5 the PG comparator drives high when the OUT pin rises above 4.35V and low when OUT falls below 4.27V.

Once the PG comparator is high, the GATE pin voltage is monitored with respect to the OUT pin. Once the GATE minus OUT voltage exceeds 4.2V, the  $\overline{\text{PG}}$  pin goes low. This indicates to the system that it is safe to load the OUT pin while the MOSFET is completely turned “on”. The  $\overline{\text{PG}}$  pin goes high when the GATE is commanded off (using the  $\overline{\text{EN1}}$ ,  $\overline{\text{EN2}}$  or SENSE pins) or when the PG comparator drives low.

### Design Example

Consider the following design example (Figure 5):  $V_{\text{IN}} = 12\text{V}$ ,  $I_{\text{MAX}} = 5\text{A}$ ,  $I_{\text{INRUSH}} = 100\text{mA}$ ,  $C_{\text{L}} = 330\mu\text{F}$ ,  $V_{\text{PGTHRESHOLD}} = 10.5\text{V}$ .

The inrush current is defined by the current required to charge the output capacitor using the fixed 0.3V/ms GATE charge up rate. The inrush current is defined as:

$$I_{\text{INRUSH}} = C_{\text{L}} \cdot 0.3[\text{V/ms}] = 330\mu\text{F} \cdot 0.3[\text{V/ms}] = 100\text{mA}$$

As mentioned previously, the charge up time is the output voltage (12V) divided by the output rate of 0.3V/ms resulting in 40ms. The peak power dissipation of 12V at 100mA (or 1.2W) is within the SOA of the pass MOSFET for 40ms (see MOSFET SOA curve in the Typical Performance Characteristics section).

Next the power dissipated in the MOSFET during overcurrent must be limited. The active current limit uses a timer to prevent excessive energy dissipation in the MOSFET. The worst-case power dissipation occurs when the voltage versus current profile of the foldback current limit is at the maximum. This occurs when the current is 6.1A and the voltage is one half of the  $V_{\text{IN}}$  or 6V. See the Current Limit Threshold Foldback vs FB Voltage in the Typical Performance Characteristics section to view this profile. In order to survive 36W, the MOSFET SOA dictates a maximum time of 10ms (see SOA graph). Use the internal 2ms timer invoked by tying the TIMER pin to  $\text{INTV}_{\text{CC}}$ .

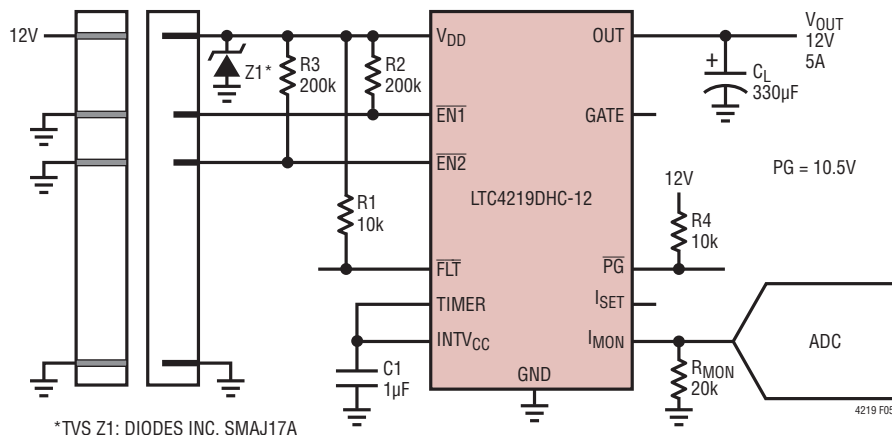

Figure 5. 5A, 12V Card Resident Application

## APPLICATIONS INFORMATION

The power good threshold using the internal resistive divider on the FB pin matches the 10.5V requirement. The final schematic in Figure 5 results in very few external components. The pull-up resistors, R1 and R4, connect to the  $\overline{\text{FLT}}$  and  $\overline{\text{PG}}$  pins while the 20k ( $R_{\text{MON}}$ ) converts the  $I_{\text{MON}}$  current to a voltage at a ratio:

$$V_{I_{\text{MON}}} = 20[\mu\text{A/A}] \cdot 20\text{k} \cdot I_{\text{OUT}} = 0.4[\text{V/A}] \cdot I_{\text{OUT}}$$

In addition there is a 1 $\mu\text{F}$  bypass (C1) on the  $\text{INTV}_{\text{CC}}$  pin.

### Layout Considerations

In Hot Swap applications where load currents can be 5A, narrow PCB tracks exhibit more resistance than wider tracks and operate at elevated temperatures. The minimum trace width for 1oz copper foil is 0.02" per amp to make sure the trace stays at a reasonable temperature. Using 0.03" per amp or wider is recommended. Note that 1oz copper exhibits a sheet resistance of about 0.5m $\Omega$ /square. Small resistances add up quickly in high current applications.

There are two  $V_{\text{DD}}$  pins on opposite sides of the package that connect to the sense resistor and MOSFET. The PCB layout should be balanced and symmetrical to each  $V_{\text{DD}}$  pin to balance current in the MOSFET bond wires. Figure 6 shows a recommended layout for the LTC4219.

Although the MOSFET is self protected from overtemperature, it is recommended to solder the backside of the package to a copper trace to provide a good heat sink. Note that the backside is connected to the SENSE pin and cannot be soldered to the ground plane. During normal

loads the power dissipated in the package is as high as 1.9W. A 10mm  $\times$  10mm area of 1oz copper should be sufficient. This area of copper can be divided in many layers.

It is also important to put C1, the bypass capacitor for the  $\text{INTV}_{\text{CC}}$  pin as close as possible between the  $\text{INTV}_{\text{CC}}$  and GND.

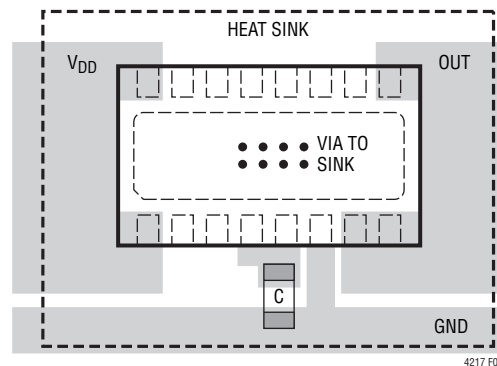

Figure 6. Recommended Layout

### Additional Applications

The LTC4219 has a wide operating range from 2.9V to 15V. The PG threshold is set with an internal resistive divider. All other functions are independent of supply voltage.

Figure 7 shows a 5V application with a PG threshold of 4.35V.

In addition to Hot Swap applications, the LTC4219 also functions as a backplane resident switch for removable load cards (see the Typical Application section).

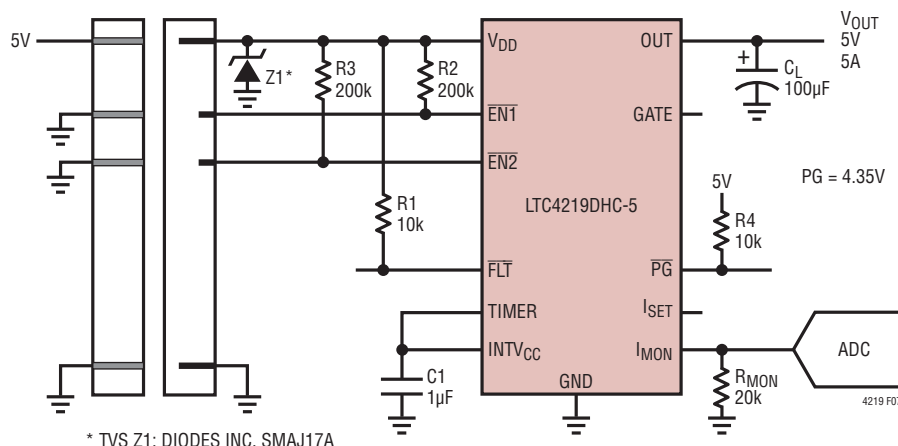

\* TVS Z1: DIODES INC. SMAJ17A

Figure 7. 5V, 5A Card Resident Application





## REVISION HISTORY

REV	DATE	DESCRIPTION	PAGE NUMBER
A	8/10	Revised conditions for $A_{IMON}$ , $I_{OFF(IMON)}$ , and $t_{PHL(ILIM)}$ in Electrical Characteristics section.	4
B	10/10	Revised $V_{INTVCC}$ TYP value from 3.0 to 3.1 in Electrical Characteristics section	4
		Revised TIMER pin description in Pin Functions section	8
		Revised TM1 + value from 0.2V to 0.21V in Functional Diagram	9
		Revised voltages in 4th paragraph of Operation section	10
		Revised 170mA to 140mA in Turn-Off Sequence section of the Applications Infomation	12
C	04/15	Typical Application: Added SMAJ22A and 200k $\bar{E}N$ Resistors	1
		Increased Capacitance on $INTV_{CC}$ to 1 $\mu$ F from 0.1 $\mu$ F	Multiple
		Raised $I_{GATE(DN)}$ Maximum from 340 $\mu$ A to 400 $\mu$ A	4
		Updated TPCs G02, G09, G11, G12, G14, G16	5, 6, 7
		$I_{SET}$ Pin Function: Recommended Minimum Resistor Value to Be 2k	8
		Figure 1: Added Auto-Retry (Q1), Z1, R2-R4, $C_{COMP}$ ; Updated C1, $R_{GATE}$	11
		Added Paragraph Explaining Auto-Retry with MOSFET Q1	13
		Figures 5, 7: Added Z1, $\bar{E}N$ Pull-Up Resistors; Updated C1 Value	14, 15
Typical Application: Added SMAJ22A; Raised $INTV_{CC}$ Capacitor to 1 $\mu$ F	18		
D	10/15	Changed input TVS to SMAJ17A in application circuit.	1, 11, 14, 15, 18
		Clarified that operating temperature range refers to ambient.	2
		Added $BW_{IMON}$ and $t_{D(FAULT)}$ specifications.	4
		Updated $INTV_{CC}$ and $I_{SET}$ pin functions.	8
		Added equations to calculate MOSFET temperature.	13