

## FEATURES

- Allows Safe Board Insertion into a Live Backplane
- Small Footprint
- 10mΩ MOSFET Including R<sub>SENSE</sub>
- Safe Operating Area Guaranteed at 41W, 30ms
- Wide Operating Voltage Range: 2.9V to 15V
- Adjustable, 11% Accurate Current Limit
- Current and Temperature Monitor Outputs
- Overtemperature Protection
- Adjustable Current Limit Timer Before Fault
- Power Good and Fault Outputs
- Adjustable Inrush Current Control
- 2.5% Accurate Undervoltage and Overvoltage Protection
- Available in 38-Lead (5mm × 9mm) QFN Package
- Pin Compatible with LTC4234

## APPLICATIONS

- High Availability Servers
- Solid State Drives
- Industrial
- Network Routers and Switches

## DESCRIPTION

The LTC<sup>®</sup>4233 is an integrated solution for Hot Swap<sup>™</sup> applications that allows a board to be safely inserted and removed from a live backplane. The part integrates a Hot Swap controller, power MOSFET and current sense resistor in a single package for small form factor applications. The MOSFET Safe Operating Area is production tested and guaranteed for the stresses in Hot Swap applications.

The LTC4233 provides separate inrush current control and an 11% accurate 11.2A current limit with output dependent foldback. The current limit threshold can be adjusted dynamically using the I<sub>SET</sub> pin. Additional features include a current monitor output that amplifies the sense resistor voltage for ground referenced current sensing and a MOSFET temperature monitor output. Thermal limit, overvoltage, undervoltage and power good monitoring are also provided. For a 20A pin compatible version see LTC4234.

LT, LT, LTC, LTM, Linear Technology and the Linear logo are registered trademarks and Hot Swap and PowerPath are trademarks of Linear Technology Corporation. All other trademarks are the property of their respective owners.

## TYPICAL APPLICATION

12V, 10A Card Resident Application with Auto-Retry

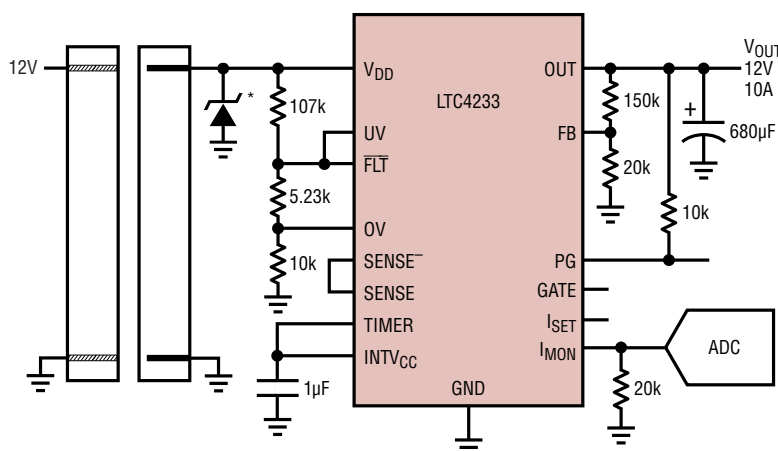

\*TVS: DIODES INC. SMAJ17A

4233 TA01a

Power-Up Waveforms

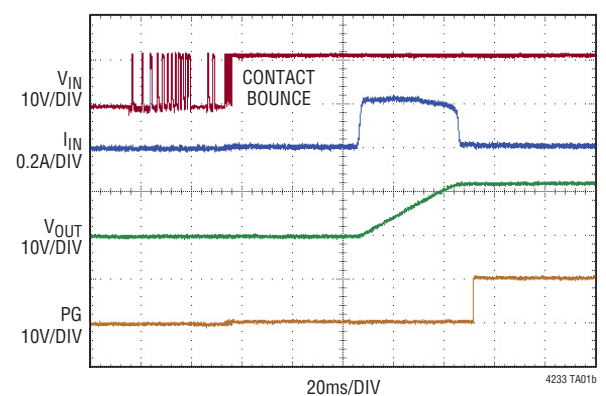

20ms/DIV

4233 TA01b

# LTC4233

## ABSOLUTE MAXIMUM RATINGS

(Notes 1, 2)

Supply Voltage ( $V_{DD}$ )	-0.3V to 28V
Input Voltages	
FB, OV, UV	-0.3V to 12V
TIMER	-0.3V to 3.5V
SENSE <sup>-</sup> , SENSE	$V_{DD} - 10V$ or $-0.3V$ to $V_{DD} + 0.3V$
Output Voltages	
$I_{SET}$ , $I_{MON}$	-0.3V to 3V
PG, FLT	-0.3V to 35V
OUT	-0.3V to $V_{DD} + 0.3V$
INTV <sub>CC</sub>	-0.3V to 3.5V
GATE (Note 3)	-0.3V to 33V
Operating Ambient Temperature Range	
LTC4234C	0°C to 70°C
LTC4234I	-40°C to 85°C
LTC4234H	-40°C to 125°C
Junction Temperature (Note 4, 5)	150°C
Storage Temperature Range	-65°C to 150°C

## PIN CONFIGURATION

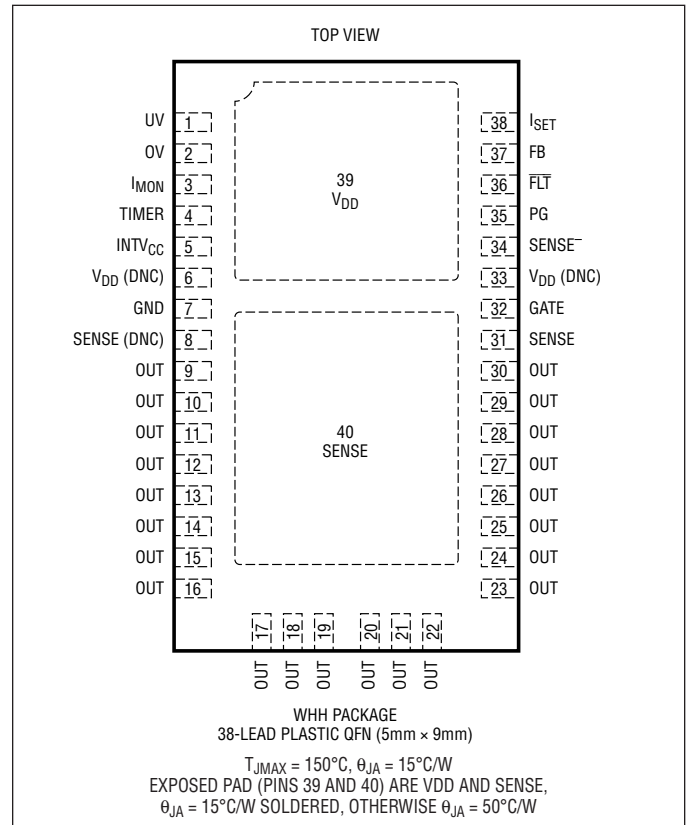

## ORDER INFORMATION

LEAD FREE FINISH	TAPE AND REEL	PART MARKING	PACKAGE DESCRIPTION	TEMPERATURE RANGE
LTC4233CWHH#PBF	LTC4233CWHH#TRPBF	4233	38-Lead (5mm × 9mm) Plastic QFN	0°C to 70°C
LTC4233IWHH#PBF	LTC4233IWHH#TRPBF	4233	38-Lead (5mm × 9mm) Plastic QFN	-40°C to 85°C
LTC4233HWHH#PBF	LTC4233HWHH#TRPBF	4233	38-Lead (5mm × 9mm) Plastic QFN	-40°C to 125°C

Consult LTC Marketing for parts specified with wider operating temperature ranges.

Consult LTC Marketing for information on nonstandard lead based finish parts.

For more information on lead free part marking, go to: <http://www.linear.com/leadfree/>

For more information on tape and reel specifications, go to: <http://www.linear.com/tapeand reel/>

## ELECTRICAL CHARACTERISTICS

The ● denotes the specifications which apply over the full operating temperature range, otherwise specifications are at  $T_A = 25^\circ\text{C}$ .  $V_{DD} = 12\text{V}$  unless otherwise noted.

SYMBOL	PARAMETER	CONDITIONS		MIN	TYP	MAX	UNITS
<b>DC Characteristics</b>							
$V_{DD}$	Input Supply Range		●	2.9		15	V
$I_{DD}$	Input Supply Current	MOSFET On, No Load	●		1.6	3	mA
$V_{DD(UVL)}$	Input Supply Undervoltage Lockout	$V_{DD}$ Rising	●	2.63	2.73	2.85	V
$I_{OUT}$	OUT Leakage Current	$V_{OUT} = V_{GATE} = 0\text{V}$ , $V_{DD} = 15\text{V}$ $V_{OUT} = V_{GATE} = 12\text{V}$	● ●	1	0 2	$\pm 300$ 4	$\mu\text{A}$ $\mu\text{A}$
$dV_{GATE}/dt$	OUT Turn-on Ramp Rate	Gate Open	●	0.15	0.3	0.6	V/ms
$R_{ON}$	MOSFET + Sense Resistor On-Resistance	C-Grade, I-Grade H-Grade	● ●	4.5 4.5	10 10	14.5 16.5	$\text{m}\Omega$ $\text{m}\Omega$
$I_{LIM(TH)}$	Current Limit Threshold	$V_{FB} = 1.35\text{V}$ , $I_{SET}$ Open $V_{FB} = 0\text{V}$ , $I_{SET}$ Open $V_{FB} = 1.35\text{V}$ , $R_{SET} = 20\text{k}$	● ● ●	10 2.0 4.7	11.2 2.8 5.6	12.4 3.7 6.4	A A A
SOA	MOSFET Safe Operating Area	$V_{DS} = 13.5\text{V}$ , 3A Folded Back, $50\text{W}^2\text{s}$ (Note 6) $V_{DS} = 7.5\text{V}$ , 11A Onset of Foldback, $50\text{W}^2\text{s}$ (Note 7)		30 7			ms ms
<b>Inputs</b>							
$I_{IN}$	OV, UV, FB Input Current	$V = 1.2\text{V}$	●		0	$\pm 1$	$\mu\text{A}$
$I_{SENSE-(IN)}$	SENSE <sup>-</sup> Input Current	$V_{SENSE-} = 12\text{V}$	●		4	$\pm 10$	$\mu\text{A}$
$V_{TH}$	OV, UV, FB Threshold Voltage	$V_{PIN}$ Rising	●	1.205	1.235	1.265	V
$\Delta V_{OV(HYST)}$	OV Hysteresis		●	10	20	30	mV
$\Delta V_{UV(HYST)}$	UV Hysteresis		●	50	80	110	mV
$V_{UV(RTH)}$	UV Reset Threshold Voltage	$V_{UV}$ Falling	●	0.55	0.62	0.7	V
$\Delta V_{FB(HYST)}$	FB Power Good Hysteresis		●	10	20	30	mV
$R_{ISET}$	$I_{SET}$ Internal Resistor		●	19	20	21	$\text{k}\Omega$
<b>Outputs</b>							
$V_{INTVCC}$	INTV <sub>CC</sub> Output Voltage	$V_{DD} = 5\text{V}, 15\text{V}$ , $I_{SINK} = 0\text{mA}$ , $-10\text{mA}$	●	2.8	3.1	3.3	
$V_{OL}$	PG, $\overline{\text{FLT}}$ Pin Output Low Voltage	$I_{SINK} = 2\text{mA}$	●		0.4	0.8	V
$I_{OH}$	PG, $\overline{\text{FLT}}$ Pin Input Leakage Current	$V = 30\text{V}$	●		0	$\pm 10$	$\mu\text{A}$
$V_{TIMER(H)}$	TIMER High Threshold	$V_{TIMER}$ Rising	●	1.2	1.235	1.28	V
$V_{TIMER(L)}$	TIMER Low Threshold	$V_{TIMER}$ falling	●	0.1	0.21	0.3	V
$I_{TIMER(UP)}$	TIMER Pull Up Current	$V_{TIMER} = 0\text{V}$	●	-80	-100	-120	$\mu\text{A}$
$I_{TIMER(DN)}$	TIMER Pull Down Current	$V_{TIMER} = 1.2\text{V}$	●	1.4	2	2.6	$\mu\text{A}$
$I_{TIMER(RATIO)}$	TIMER Current Ratio $I_{TIMER(DN)}/I_{TIMER(UP)}$		●	1.6	2	2.7	%
$A_{IMON}$	$I_{MON}$ Current Gain		●	9	10	10.5	$\mu\text{A}/\text{A}$
$BW_{IMON}$	$I_{MON}$ Bandwidth				250		$\text{kHz}$
$I_{OFF(IMON)}$	$I_{MON}$ Offset Current	$I_{OUT} = 300\text{mA}$	●		0	$\pm 9$	$\mu\text{A}$
$I_{GATE(UP)}$	Gate Pull-Up Current	Gate Drive On, $V_{GATE} = V_{OUT} = 12\text{V}$	●	-18	-24	-29	$\mu\text{A}$
$I_{GATE(DN)}$	Gate Pull-Down Current	Gate Drive Off, $V_{GATE} = 18\text{V}$ , $V_{OUT} = 12\text{V}$	●	180	250	500	$\mu\text{A}$
$I_{GATE(FST)}$	Gate Fast Pull-Down Current	Fast Turn Off, $V_{GATE} = 18\text{V}$ , $V_{OUT} = 12\text{V}$			140		mA

## ELECTRICAL CHARACTERISTICS

The ● denotes the specifications which apply over the full operating temperature range, otherwise specifications are at  $T_A = 25^\circ\text{C}$ .  $V_{DD} = 12\text{V}$  unless otherwise noted.

SYMBOL	PARAMETER	CONDITIONS		MIN	TYP	MAX	UNITS
<b>AC Characteristics</b>							
$t_{PHL(GATE)}$	Input High (OV), Input Low (UV) to GATE Low Propagation Delay	$V_{GATE} < 17.8\text{V}$ Falling	●		8	20	$\mu\text{s}$
$t_{PHL(ILIM)}$	Short Circuit to GATE Low	$V_{FB} = 0$ , Step $V_{DD} - \text{SENSE}^-$ to 50mV, $V_{GATE} < 15\text{V}$ Falling	●		1	5	$\mu\text{s}$
$t_{D(ON)}$	Turn-On Delay	Step $V_{UV}$ to 2V, $V_{GATE} > 13\text{V}$	●	24	48	72	ms
$t_{D(FAULT)}$	UV Low to Clear Fault Latch Delay				1		$\mu\text{s}$
$t_{D(CB)}$	Circuit Breaker Filter Delay Time (Internal)	$V_{FB} = 0$ , Step $V_{DD} - \text{SENSE}^-$ to 50mV	●	1.2	2	2.7	ms
$t_{D(COOL-DOWN)}$	Cool Down Delay (Internal)		●	600	900	1200	ms

**Note 1:** Stresses beyond those listed under Absolute Maximum Ratings may cause permanent damage to the device. Exposure to any Absolute Maximum Rating condition for extended periods may affect device reliability and lifetime.

**Note 2:** All currents into pins are positive; all voltages are referenced to GND unless otherwise specified.

**Note 3:** An internal clamp limits the GATE pin to a maximum of 6.5V above OUT. Driving this pin to voltages beyond the clamp may damage the device.

**Note 4:** This IC includes overtemperature protection that is intended to protect the device during momentary overload conditions. Junction temperature will exceed  $150^\circ\text{C}$  when overtemperature protection is active. Continuous operation above the specified maximum operating junction temperature may impair device reliability.

**Note 5:**  $T_J$  is calculated from the ambient temperature,  $T_A$ , and power dissipation,  $P_D$ , according to the formula:

$$T_J = T_A + (P_D \cdot 15^\circ\text{C}/\text{W})$$

**Note 6:** SOA tested at room temperature, SOA (i.e.  $P^2t$ ) is reduced at elevated temperatures according to the following formula:

$$P^2t(T_J) = 50 [\text{W}^2\text{s}] \cdot \left[ \frac{150^\circ\text{C} - T_J}{150^\circ\text{C} - 25^\circ\text{C}} \right]^2$$

**Note 7:** Guaranteed by design and extrapolated from  $P^2t$  limit of  $50\text{W}^2\text{s}$ .

**TYPICAL PERFORMANCE CHARACTERISTICS**  $T_A = 25^\circ\text{C}$ ,  $V_{DD} = 12\text{V}$  unless otherwise noted.

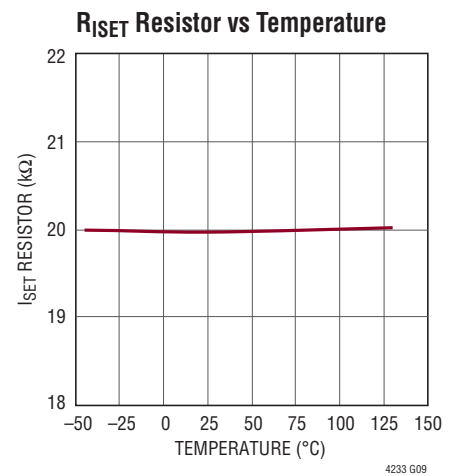
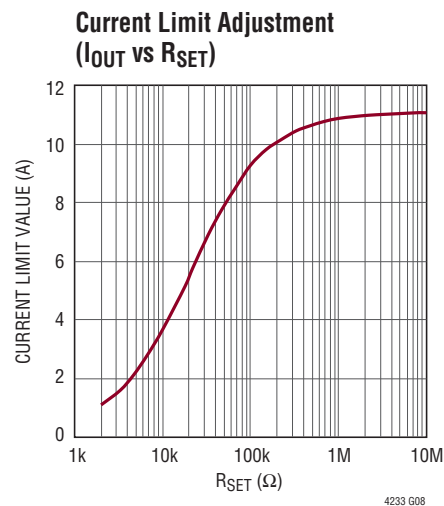
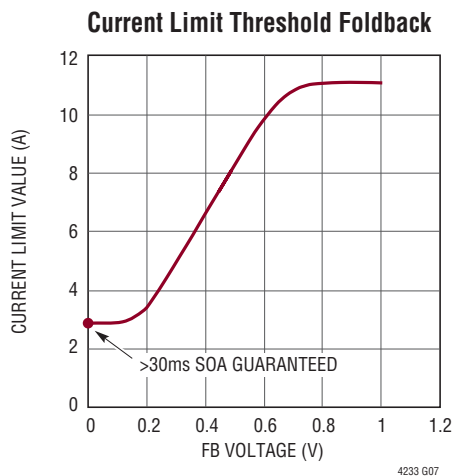
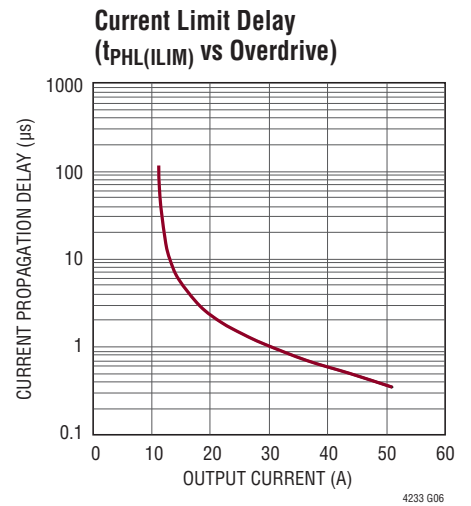
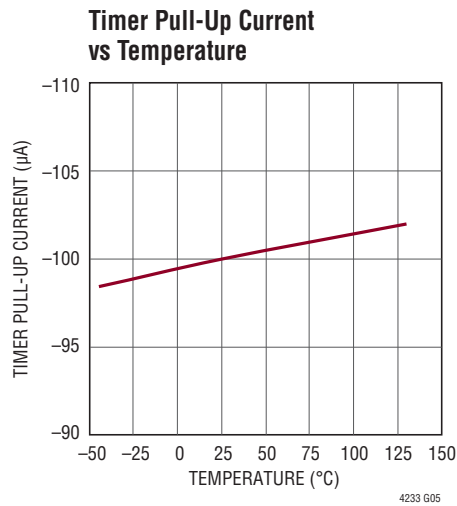
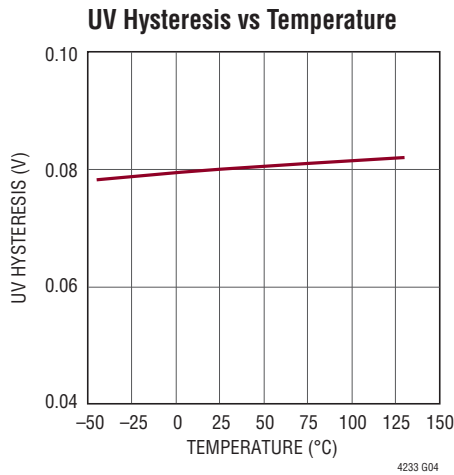
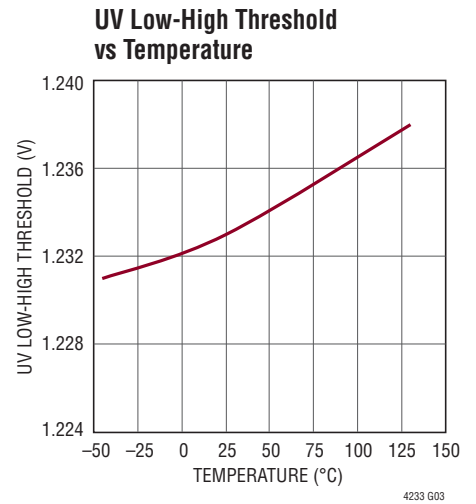
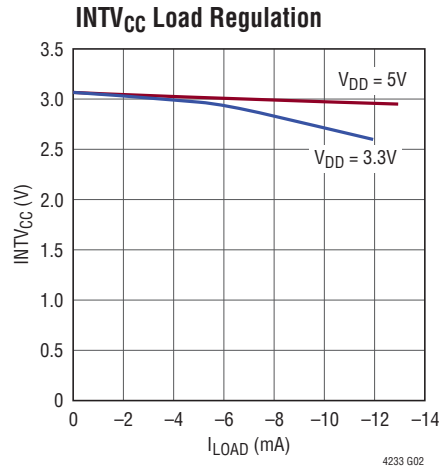
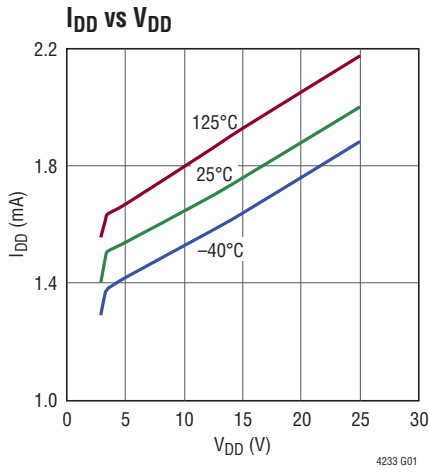

## TYPICAL PERFORMANCE CHARACTERISTICS $T_A = 25^\circ\text{C}$ , $V_{DD} = 12\text{V}$ unless otherwise noted.

### $R_{ON}$ vs Temperature

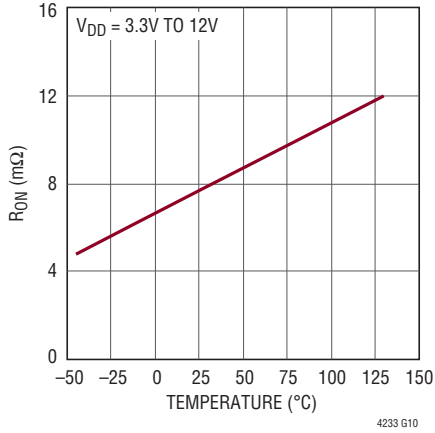

### SOA Constant vs Junction Temperature

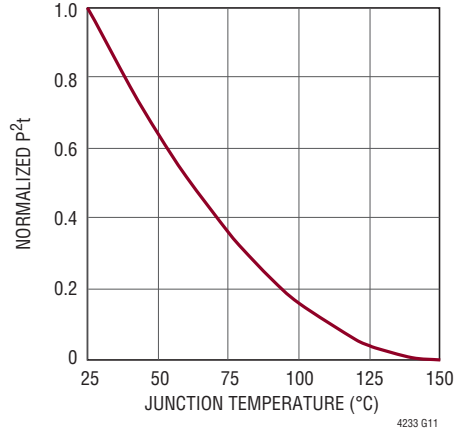

### Guaranteed MOSFET SOA Curve

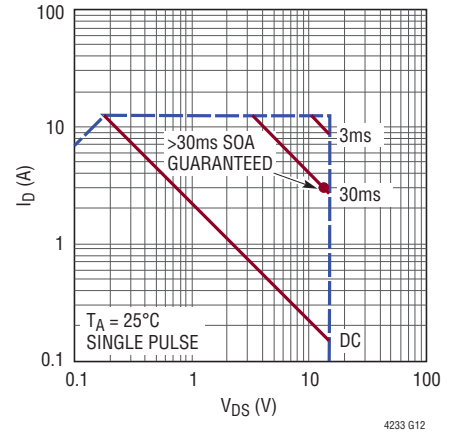

### PG, $\overline{\text{FLT}}$ Output Low vs $I_{\text{SINK}}$

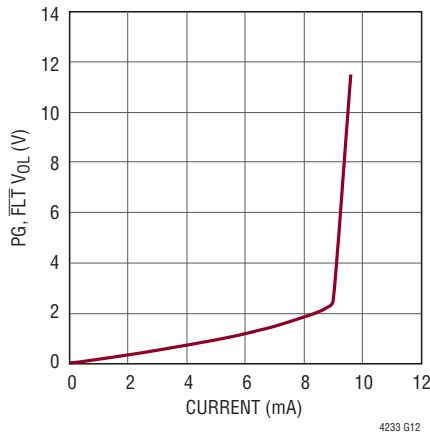

### $I_{\text{MON}}$ vs Temperature

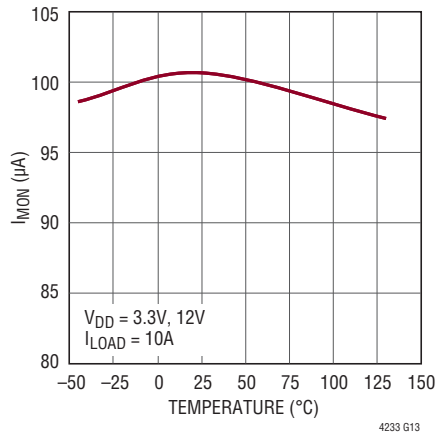

### GATE Pull-Up Current vs Temperature

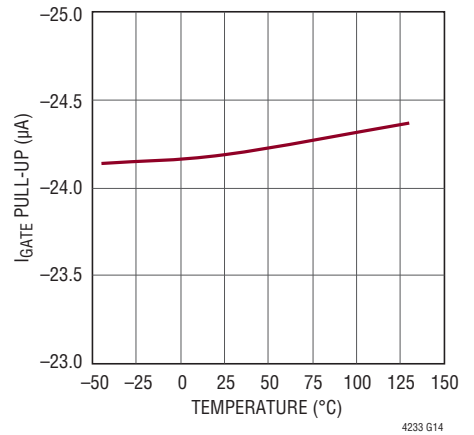

### Gate Drive vs Gate Pull-Up Current

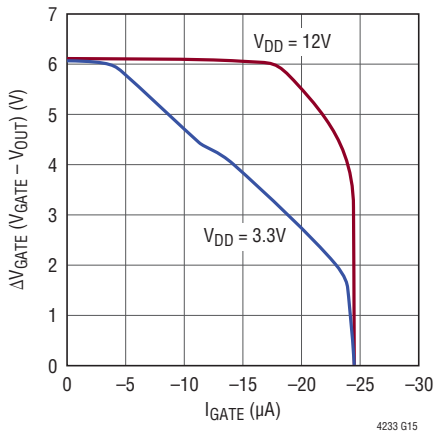

### Gate Drive vs $V_{DD}$

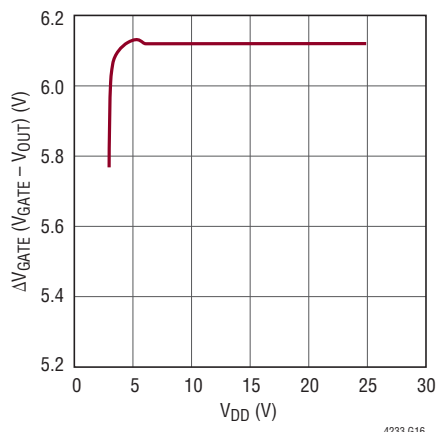

### $V_{\text{SET}}$ vs Temperature

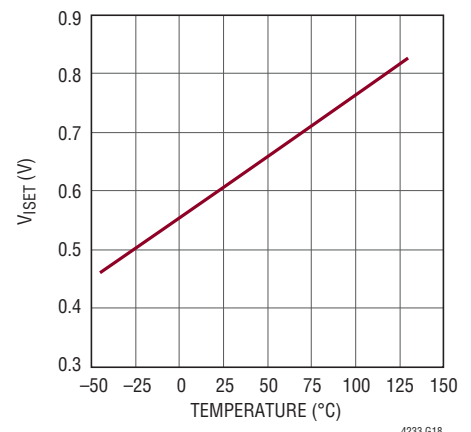

## PIN FUNCTIONS

**DNC:** Do Not Connect. Leave open.

**FB:** Foldback and Power Good Input. Connect this pin to an external resistive divider from OUT. If the voltage falls below 0.6V, the current limit is reduced using a foldback profile (see the Typical Performance Characteristics section). If the voltage falls below 1.21V, the PG pin will pull low to indicate the power is bad

**FLT:** Overcurrent fault indicator. Open-drain output pulls low when an overcurrent fault has occurred and the circuit breaker trips. For overcurrent auto-retry tie to UV pin (see Applications Information section for details).

**GATE:** Gate Drive for internal N-Channel MOSFET. An internal 24 $\mu$ A current source charges the gate of the N-channel MOSFET. At start-up the GATE pin ramps up at a 0.35V/ms rate determined by internal circuitry. During an undervoltage or overvoltage condition a 250 $\mu$ A pull-down current turns the MOSFET off. During a short circuit or undervoltage lockout condition, a 140mA pull-down current source between GATE and OUT is activated.

**GND:** Device Ground.

**I<sub>MON</sub>:** Current Monitor Output. The current in the internal MOSFET switch is divided by 100,000 and sourced from this pin. Placing a 20k resistor on this pin allows a 0 to 2V voltage swing when current ranges from 0A to 10A.

**INTV<sub>CC</sub>:** Internal 3.1V Supply Decoupling Output. This pin must have a 1 $\mu$ F or larger bypass capacitor. Overloading this pin can disrupt internal operation.

**I<sub>SET</sub>:** Current Limit Adjustment Pin. For 11.2A current limit value open this pin. This pin is driven by a 20k resistor in series with a voltage source. The pin voltage is used to generate the current limit threshold. The internal 20k resistor ( $R_{ISET}$ ) and an external resistor ( $R_{SET}$ ) between I<sub>SET</sub> and ground create an attenuator that lowers the current limit value. Due to circuit tolerance  $R_{SET}$  should not be less than 2k. In order to match the temperature variation of the sense resistor, the voltage on this pin is made proportional to temperature of the MOSFET switch.

**OUT:** Output of internal MOSFET switch. Connect this pin directly to the load.

**OV:** Overvoltage Comparator Input. Connect this pin to an external resistive divider from V<sub>DD</sub>. If the voltage at this pin rises above 1.235V, an overvoltage is detected and the switch turns off. Tie to GND if unused.

**PG:** Power good indicator. Open drain output pulls low when the FB pin drops below 1.21V indicating the power is bad. If the voltage at FB rises above 1.235V and the GATE to OUT voltage exceeds 4.2V, the open-drain pull-down releases the PG pin to go high.

**SENSE:** Current Sense Node and MOSFET Drain. One exposed pad on the UH package is connected to SENSE and should be soldered to an electrically isolated printed circuit board trace to properly transfer the heat out of the package. Connect the SENSE Pin 31 to the SENSE<sup>-</sup> Pin 34.

**SENSE<sup>-</sup>:** Current Limit and Current Monitor Amplifier Input. The current limit circuit controls the GATE pin to limit the voltage between the V<sub>DD</sub> and SENSE<sup>-</sup> pins to 15mV (11.2A) or less depending on the voltage at the FB pin. This pin must be connected to SENSE pin on the right side (connect pin 34 to pin 31).

**TIMER:** Current Limit Timer Input. Connect a capacitor between this pin and ground to set a 12 ms/ $\mu$ F duration for current limit before the switch is turned off. If the UV pin is toggled low while the MOSFET switch is off, the switch will turn on again following cool-down time of 4.14s/ $\mu$ F duration. Tie this pin to INTV<sub>CC</sub> for a fixed 2ms overcurrent delay and 900ms cool-down time.

**UV:** Undervoltage Comparator Input. Tie high to INTV<sub>CC</sub> if unused. Connect this pin to an external resistive divider from V<sub>DD</sub>. If the UV pin voltage falls below 1.15V, an undervoltage is detected and the switch turns off. Pulling this pin below 0.62V resets the overcurrent fault and allows the switch to turn back on (see Application Information section for details). If overcurrent auto-retry is desired then tie this pin to the FLT pin.

**V<sub>DD</sub>:** Supply Voltage and Current Sense Input. This exposed pad must be soldered to input power. V<sub>DD</sub> has an undervoltage lockout threshold of 2.73V.

## FUNCTIONAL BLOCK DIAGRAM

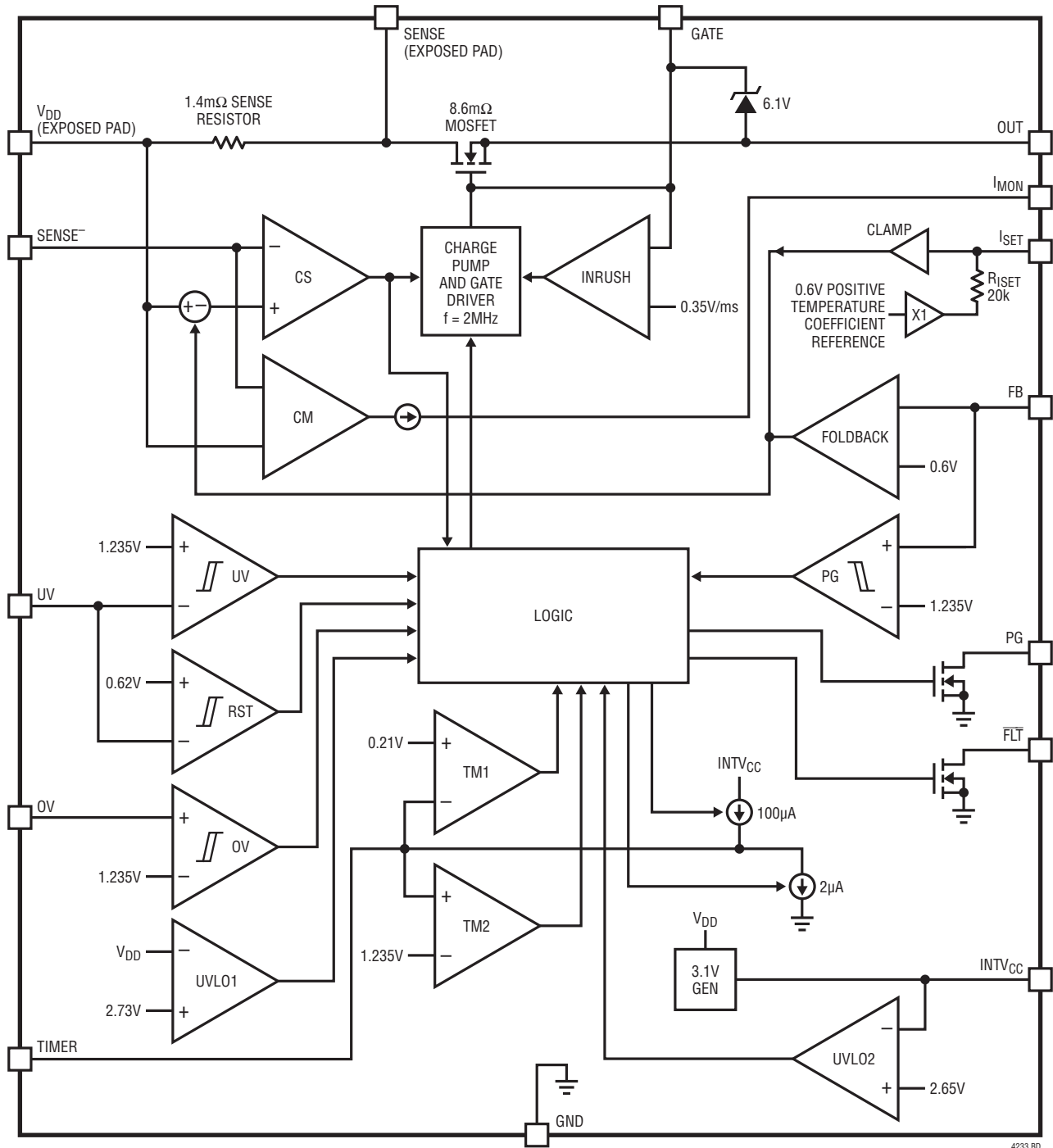

4233 BD



## OPERATION

The Functional Block Diagram displays the main circuits of the device. The LTC4233 is designed to turn a board's supply voltage on and off in a controlled manner allowing the board to be safely inserted and removed from a live backplane. The LTC4233 includes a  $8.6\text{m}\Omega$  MOSFET and a  $1.4\text{m}\Omega$  current sense resistor. During normal operation, the charge pump and gate driver turn on the pass MOSFET's gate to provide power to the load. The inrush current control is accomplished by the INRUSH circuit. This circuit limits the GATE ramp rate to  $0.35\text{V/ms}$  and hence controls the voltage ramp rate of the output capacitor.

The current sense (CS) amplifier monitors the load current using the voltage sensed across the current sense resistor. The CS amplifier limits the current in the load by reducing the GATE-to-OUT voltage in an active control loop. It is simple to adjust the current limit threshold using the current limit adjustment ( $I_{\text{SET}}$ ) pin. This allows a different threshold during other times such as startup. Note there must be a connection between SENSE to SENSE<sup>-</sup> (Pin 34 to Pin 31) in order to monitor current.

A short circuit on the output to ground causes significant power dissipation during active current limiting. To limit this power, the foldback amplifier reduces the current limit value from  $11.2\text{A}$  to  $2.8\text{A}$  in a linear manner as the FB pin drops below  $0.6\text{V}$  (see the Typical Performance Characteristics).

If an overcurrent condition persists, the TIMER pin ramps up with a  $100\mu\text{A}$  current source until the pin voltage exceeds  $1.235\text{V}$  (comparator TM2). This indicates to the logic that it is time to turn off the pass MOSFET to prevent overheating. At this point the TIMER pin ramps down using the  $2\mu\text{A}$  current source until the voltage drops below

$0.21\text{V}$  (Comparator TM1) which completes one timer cycle. After eight TIMER pin cycles (ramping to  $1.235\text{V}$  and then below  $0.21\text{V}$ ) the logic starts the internal  $48\text{ms}$  timer. At this point, the pass transistor has cooled and it is safe to turn it on again. It is suitable in many applications to use an internal  $2\text{ms}$  overcurrent timer with a  $900\text{ms}$  cool down period. Tying the TIMER pin to INTV<sub>CC</sub> sets this default timing. Latchoff is the normal operating condition following overcurrent turnoff. Retry is initiated by pulling the UV pin low for a minimum of  $1\mu\text{s}$  then high. Auto-retry is implemented by tying the  $\overline{\text{FLT}}$  to the UV pin.

The output voltage is monitored using the FB pin and the PG comparator to determine if the power is available for the load. The power good condition is signaled by the PG pin using an open-drain pull-down transistor.

The Functional Block Diagram shows the monitoring blocks of the LTC4233. The two comparators on the left side include the UV and OV comparators. These comparators are used to determine if the external conditions are valid prior to turning on the MOSFET. But first the undervoltage lockout circuits UVLO1 and UVLO2 must validate the input supply and the internally generated  $3.1\text{V}$  supply (INTV<sub>CC</sub>) and generate the power up initialization to the logic circuits. If the external conditions remain valid for  $48\text{ms}$  the MOSFET is allowed to turn on.

Other monitoring features include MOSFET current and temperature monitoring. The current monitor (CM) outputs a current proportional to the sense resistor current. This current can drive an external resistor or other circuits for monitoring purposes. A voltage proportional to the MOSFET temperature is output to the  $I_{\text{SET}}$  pin. The MOSFET is protected by a thermal shutdown circuit.



## APPLICATIONS INFORMATION

Adding a capacitor and a 100k series resistor from GATE to ground will lower the inrush current below the default value set by the INRUSH circuit. The 3.3nF capacitor,  $C_{COMP}$ , is necessary to compensate the current limit regulation loop when the  $R_{GATE}$  and  $C_{GATE}$  network is on the GATE pin. The GATE is charged with a  $24\mu A$  current source (when INRUSH circuit is not driving the GATE). The voltage at the GATE pin rises with a slope equal to  $24\mu A/C_{GATE}$  and the supply inrush current is set at:

$$I_{INRUSH} = \frac{C_L}{C_{GATE}} \cdot 24\mu A$$

When the GATE voltage reaches the MOSFET threshold voltage, the switch begins to turn on and the OUT voltage follows the GATE voltage as it increases. Once OUT reaches  $V_{DD}$ , the GATE will ramp up until clamped by the 6.1V Zener between GATE and OUT.

As the OUT voltage rises, so will the FB pin which is monitoring it. Once the FB pin crosses its 1.235V threshold and the GATE to OUT voltage exceeds 4.2V, the PG pin will cease to pull low and indicate that the power is good.

### Parasitic MOSFET Oscillation

When the N-channel MOSFET ramps up the output during power-up it operates as a source follower. The source follower configuration may self-oscillate in the range of 25kHz to 300kHz when the load capacitance is less than  $10\mu F$ , especially if the wiring inductance from the supply to  $V_{DD}$  pin is greater than  $3\mu H$ . The possibility of oscillations will increase as the load current (during power-up) increases. There are two ways to prevent this type of oscillation. The simplest way is to avoid load capacitances below  $10\mu F$ . For wiring inductances larger than  $20\mu H$ , the minimum load capacitance may extend to  $100\mu F$ . A second choice is to connect an external gate capacitor  $C_P > 1.5nF$  as shown in Figure 3.

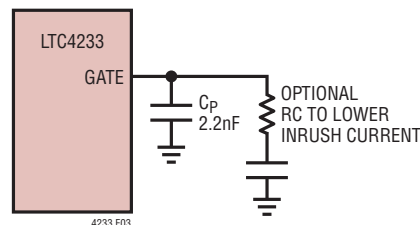

Figure 3. Compensation for Small  $C_{LOAD}$

### Turn-Off Sequence

The switch can be turned off by a variety of conditions. A normal turn-off is initiated by the UV pin going below its 1.235V threshold. Additionally, several fault conditions will turn off the switch. These include an input overvoltage (OV pin), overcurrent circuit breaker (SENSE pin) or overtemperature. Normally the switch is turned off with a  $250\mu A$  current pulling down the GATE pin to ground. With the switch turned off, the OUT voltage drops which pulls the FB pin below its threshold. The PG then pulls low to indicate output power is no longer good.

If  $V_{DD}$  drops below 2.65V for greater than  $5\mu s$  or  $INTV_{CC}$  drops below 2.5V for greater than  $1\mu s$ , a fast shutdown of the switch is initiated. The GATE is pulled down with a 140mA current to the OUT pin.

### Overcurrent Fault

The LTC4233 features an adjustable current limit with foldback that protects against short-circuits and excessive load current. To protect against excessive power dissipation in the switch during active current limit, the available current is reduced as a function of the output voltage sensed by the FB pin. A graph in the Typical Performance Characteristics curves shows the current limit threshold foldback.

## APPLICATIONS INFORMATION

An overcurrent fault occurs when the current limit circuitry has been engaged for longer than the timeout delay set by the TIMER. Current limiting begins when the MOSFET current reaches 2.8A to 11.2A (depending on the foldback). The GATE pin is then brought down with a 140mA GATE-to-OUT current. The voltage on the GATE is regulated in order to limit the current to 11.2A. At this point, a circuit breaker time delay starts by charging the external timing capacitor with a 100 $\mu$ A pull-up current from the TIMER pin. If the TIMER pin reaches its 1.235V threshold, the internal switch turns off (with a 250 $\mu$ A current from GATE to ground). Included in the Typical Performance Characteristics curves is a graph of the Safe Operating Area for the MOSFET. From this graph one can determine the MOSFET's maximum time in current limit for a given output power.

Tying the TIMER pin to INTV<sub>CC</sub> will force the part to use the internally generated (circuit breaker) delay of 2ms. In either case the FLT pin is pulled low to indicate an overcurrent fault has turned off the pass MOSFET. For a given circuit breaker time delay, the equation for setting the timing capacitor's value is as follows:

$$C_T = t_{CB} \cdot 0.083[\mu\text{F}/\text{ms}]$$

After the switch is turned off, the TIMER pin begins discharging the timing capacitor with a 2 $\mu$ A pull-down current. When the TIMER pin reaches its 0.21V threshold, it completes one timer cycle. After eight TIMER pin cycles (ramping to 1.235V and then below 0.21V) plus the 48ms debounce time the switch is allowed to turn on again if the overcurrent fault latch has been cleared. Bringing the UV pin below 0.6V for a minimum of 1 $\mu$ s and then high will clear the fault latch. If the TIMER pin is tied to INTV<sub>CC</sub> then the switch is allowed to turn on again (after an internal 900ms cool down time plus the 48ms debounce time), if the overcurrent fault latch is cleared.

Tying the  $\overline{\text{FLT}}$  pin to the UV pin allows the part to self-clear the fault and turn the MOSFET on as soon as TIMER pin has ramped below 0.21V for the eighth time followed by the 48ms debounce time. In this auto-retry mode the LTC4233 repeatedly tries to turn on after an overcurrent at a period determined by the capacitor on the TIMER pin. The auto retry mode also functions when the TIMER pin is tied to INTV<sub>CC</sub>.

The waveform in Figure 4 shows how the output latches off following a short circuit. The current in the MOSFET is 2.8A as the TIMER ramps up.

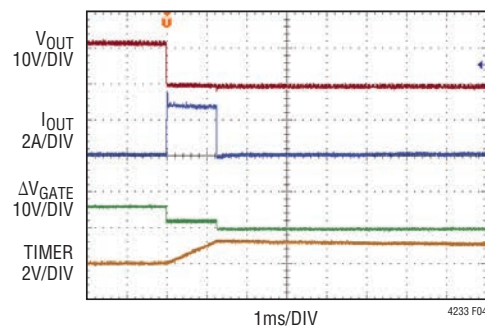

Figure 4. Short-Circuit Waveform

### Current Limit Adjustment

The default value of the active current limit is 11.2A. The current limit threshold can be adjusted lower by placing a resistor between the I<sub>SET</sub> pin and ground. As shown in the Functional Block Diagram the voltage at the I<sub>SET</sub> pin (via the clamp circuit) sets the CS amplifier's built-in offset voltage. This offset voltage directly determines the active current limit value. With the I<sub>SET</sub> pin open, the voltage at the I<sub>SET</sub> pin is determined by a positive temperature coefficient reference. This voltage is set to 0.618V which corresponds to a 11.2A current limit at room temperature.

## APPLICATIONS INFORMATION

An external resistor  $R_{SET}$  placed between the  $I_{SET}$  pin and ground forms a resistive divider with the internal 20k  $R_{ISET}$  sourcing resistor. The divider acts to lower the voltage at the  $I_{SET}$  pin and therefore lower the current limit threshold. The overall current limit threshold precision is reduced to  $\pm 15\%$  when using a 20k resistor to halve the threshold.

Using a switch (connected to ground) in series with  $R_{SET}$  allows the active current limit to change only when the switch is closed. This feature can be used to program a reduced running current while the maximum available current limit is used at startup.

### Monitor MOSFET Temperature

The voltage at the  $I_{SET}$  pin increases linearly with increasing temperature. The temperature profile of the  $I_{SET}$  pin is shown in the Typical Performance Characteristics section. Using a comparator or ADC to measure the  $I_{SET}$  voltage provides an accurate indication of the MOSFET temperature.

The  $I_{SET}$  voltage follows the formula:

$$V_{ISET} = \frac{R_{SET}}{R_{SET} + R_{ISET}} \cdot (T + 273^{\circ}\text{C}) \cdot 2.093[\text{mV}/^{\circ}\text{C}]$$

The MOSFET temperature is calculated using  $R_{ISET}$  of 20k.

$$T = \frac{(R_{SET} + 20\text{k}) \cdot V_{ISET}}{R_{SET} \cdot 2.093[\text{mV}/^{\circ}\text{C}]} - 273^{\circ}\text{C}$$

When  $R_{SET}$  is not present, T becomes:

$$T = \frac{V_{ISET}}{2.093[\text{mV}/^{\circ}\text{C}]} - 273^{\circ}\text{C}$$

There is an overtemperature circuit in the LTC4233 that monitors an internal voltage similar to the  $I_{SET}$  pin voltage. When the die temperature exceeds  $155^{\circ}\text{C}$  the circuit turns off the MOSFET until the temperature drops to  $135^{\circ}\text{C}$ .

### Monitor MOSFET Current

The current in the MOSFET passes through an internal  $1.4\text{m}\Omega$  sense resistor. The voltage on the sense resistor is converted to a current that is sourced out of the  $I_{MON}$  pin. The gain of  $I_{SENSE}$  amplifier is  $10\mu\text{A}/\text{A}$  referenced from the MOSFET current. This output current can be converted to a voltage using an external resistor to drive a comparator or ADC. The voltage compliance for the  $I_{MON}$  pin is from  $0\text{V}$  to  $\text{INTV}_{CC} - 0.7\text{V}$ .

A microcontroller with a built-in comparator can build a simple integrating single-slope ADC by resetting a capacitor that is charged with this current. When the capacitor voltage trips the comparator and the capacitor is reset, a timer is started. The time between resets will indicate the MOSFET current.

### Monitor OV and UV Faults

Protecting the load from an overvoltage condition is the main function of the OV pin. In Figure 1 an external resistive divider (driving the OV pin) connects to a comparator to turn off the MOSFET when the  $V_{DD}$  voltage exceeds  $15.2\text{V}$ . If the  $V_{DD}$  pin subsequently falls back below  $14.9\text{V}$ , the switch will be allowed to turn on immediately. In the LTC4233 the OV pin threshold is  $1.235\text{V}$  when rising, and  $1.215\text{V}$  when falling out of overvoltage.

The UV pin functions as an undervoltage protection pin or as an ON pin. In the Figure 1 application the MOSFET turns off when  $V_{DD}$  falls below  $9.23\text{V}$ . If the  $V_{DD}$  pin subsequently rises above  $9.88\text{V}$  for  $48\text{ms}$ , the switch will be allowed to turn on again. The LTC4233 UV turn-on/off thresholds are  $1.235\text{V}$  (rising) and  $1.155\text{V}$  (falling).

In the case of an undervoltage or overvoltage the MOSFET turns off and there is indication on the PG status pin. When the overvoltage is removed, the MOSFET's gate ramps up immediately at the rate determined by the INRUSH circuit.

## APPLICATIONS INFORMATION

### Power Good Indication

In addition to setting the foldback current limit threshold, the FB pin is used to determine a power good condition. The Figure 1 application uses an external resistive divider on the OUT pin to drive the FB pin. On the LTC4233 the PG comparator drives high when the FB pin rises above 1.235V and low when it falls below 1.215V.

Once the PG comparator is high the GATE pin voltage is monitored with respect to the OUT pin. Once the GATE minus OUT voltage exceeds 4.2V the PG pin goes high. This indicates to the system that it is safe to load the OUT pin while the MOSFET is completely turned on. The PG pin goes low when the GATE is commanded off (using the UV, OV or SENSE<sup>-</sup> pins) or when the PG comparator drives low.

### Design Example

Consider the following design example (Figure 5):  $T_A = 60^\circ\text{C}$ ,  $V_{IN} = 12\text{V}$ ,  $I_{MAX} = 10\text{A}$ .  $I_{INRUSH} = 240\text{mA}$ ,  $C_L = 680\mu\text{F}$ ,  $V_{UVON} = 9.88\text{V}$ ,  $V_{OVOFF} = 15.2\text{V}$ ,  $V_{PGTHRESHOLD} = 10.5\text{V}$ . A current limit fault triggers an automatic restart of the power up sequence.

The inrush current is defined by the current required to charge the output capacitor using the fixed 0.35V/ms GATE charge up rate. The inrush current is defined as:

$$I_{INRUSH} = C_L \cdot 0.35[\text{V/ms}] = 680\mu\text{F} \cdot 0.35[\text{V/ms}] = 240\text{mA}$$

As mentioned previously the charge-up time is the output voltage (12V) divided by the output rate of 0.35V/ms resulting in 34ms. The peak power dissipation of 12V at 240mA (or 2.9W) must not exceed the SOA of the pass MOSFET for 34ms (see MOSFET SOA graph in the Typical Performance Characteristics section). On the SOA graph the 30ms line crosses the 10V  $V_{DS}$  vertical line at 4A. This verifies that the 40W for 30ms is safe at room temperature. Each single point on the 3ms and 30ms lines represent a power (voltage times current) and time that follow a constant  $P^2t$  relationship of  $50\text{W}^2\text{s}$ . If the MOSFET junction temperature is elevated then the  $P^2t$  constant must be derated. At  $T_J = 60^\circ$  the new constant becomes:

$$P^2t(T_J = 60^\circ\text{C}) = 50[\text{W}^2\text{s}] \cdot \left[ \frac{150^\circ\text{C} - 60^\circ\text{C}}{150^\circ\text{C} - 25^\circ\text{C}} \right]^2 = 26[\text{W}^2\text{s}]$$

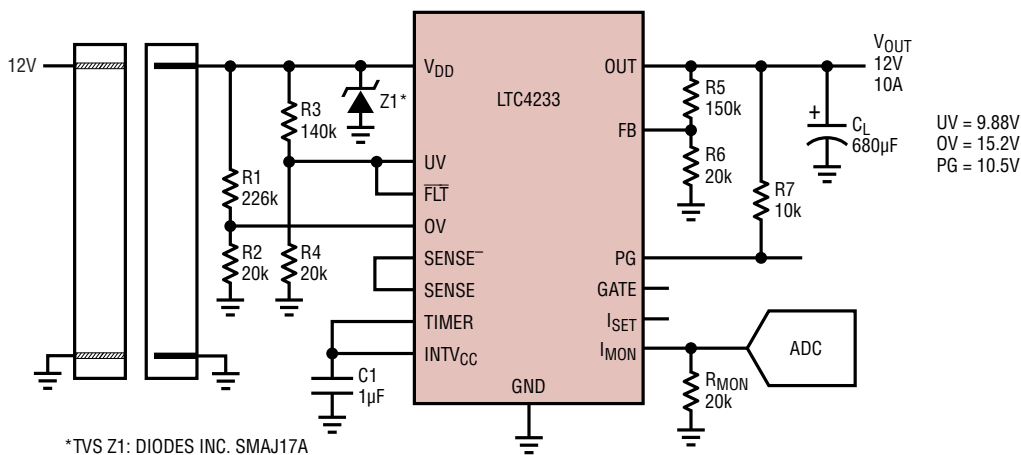

Figure 5. 10A, 12V Card Resident Application

## APPLICATIONS INFORMATION

The maximum power for 34ms can be calculated from the derated constant:

$$P_{MAX} = \sqrt{\frac{P^2 t(T_J = 60^\circ\text{C})}{t}} = \sqrt{\frac{26 [W^2s]}{34ms}} = 28W$$

Therefore, the power dissipation at charge-up is within the MOSFET SOA.

Next the power dissipated in the MOSFET during overcurrent must be limited. The active current limit uses a timer to prevent excessive energy dissipation in the MOSFET. The worst-case power dissipation occurs when the voltage versus current profile of the foldback current limit is at the maximum. This occurs when the current is 12.4A and the voltage is half of  $V_{IN}$  or 6V. See the Current Limit Threshold Foldback in the Typical Performance Characteristics section to view this profile. In order to survive 74W, the MOSFET SOA dictates a maximum current limit timeout. If the MOSFET operating temperature is elevated prior to current limit the SOA constant must be derated according to the formula:

$$P^2 t(T_J) = P^2 t(25^\circ\text{C}) \cdot \left[ \frac{150^\circ\text{C} - T_J}{150^\circ\text{C} - 25^\circ\text{C}} \right]^2$$

$T_J$  is calculated from the ambient temperature, package thermal impedance ( $\theta_{JA}$ ) and the  $I^2R$  heating.

$$T_J = (\theta_{JA} \cdot I^2 \cdot R_{ON}) + T_A = 15^\circ\text{C/W} \cdot (10A)^2 \cdot 14.5m\Omega + 60^\circ\text{C} = 82^\circ\text{C}$$

Using the SOA derating formula:

$$P^2 t(T_J = 82^\circ\text{C}) = 50 [W^2s] \cdot \left[ \frac{150^\circ\text{C} - 82^\circ\text{C}}{150^\circ\text{C} - 25^\circ\text{C}} \right]^2 = 15 [W^2s]$$

So the SOA constant is derated to  $15W^2s$ . The maximum current limit timeout is calculated from the revised constant and the 74W dissipated in current limit.

$$t_{MAX} = \frac{P^2 t(T_J = 82^\circ\text{C})}{P^2} = \frac{15 [W^2s]}{(74W)^2} = 2.7ms$$

Invoke the internal 2ms timer by tying the TIMER pin to INTV<sub>CC</sub>. To configure the LTC4233 for auto-retry after overcurrent fault, connect the  $\overline{FLT}$  to the UV pin. After the 2ms timeout the  $\overline{FLT}$  pin pulls down on the UV pin restart the power-up sequence.

The values for overvoltage, undervoltage and power good thresholds using the resistive dividers on the UV, OV and FB pins match the requirements of turn-on at 9.88V and turn-off at 15.2V.

The final schematic in Figure 5 results in very few external components. The pull-up resistor, R7, connects to the PG pin while the 20k ( $R_{MON}$ ) converts the  $I_{MON}$  current to a voltage at a ratio:

$$V_{IMON} = 10[\mu A/A] \cdot 20k \cdot I_{OUT} = 0.2[V/A] \cdot I_{OUT}$$

In addition there is a 1 $\mu$ F bypass (C1) on the INTV<sub>CC</sub> pin and note the connection between SENSE to SENSE<sup>-</sup> (Pin 34 to Pin 31).

## APPLICATIONS INFORMATION

### Layout Considerations

In Hot Swap applications where load currents can be 10A, narrow PCB tracks exhibit more resistance than wider tracks and operate at elevated temperatures. The minimum trace width requirement for 1oz copper foil is 0.02" per amp to make sure the trace stays at a reasonable temperature. Using 0.03" per amp or wider is recommended. Note that 1oz copper exhibits a sheet resistance of about 0.5mΩ/square. Small resistances add up quickly in high current applications.

The input supply should be tied to the  $V_{DD}$  exposed pad through a PCB trace that enters between Pin 1 and Pin 38. The  $V_{DD}$  pad connects to the sense resistor and MOSFET.

Globally, there are three DNC pins that are unconnected and left open (Pins 6, 8, 33). Connect the  $SENSE^-$  pin (Pin 34) to the SENSE pin (Pin 31). Figure 6 shows a recommended layout for the LTC4233.

During normal operation the power dissipated in the MOSFET could be as high as 1.5W. To remove this heat, solder the SENSE exposed pad to a copper trace that contains vias underneath the pad. The OUT pins also conduct substantial heat from the MOSFET. Connect all the OUT pins to a plane of 1oz copper. Since the trace that connects OUT pins must accommodate high current, this area of copper is usually present. It is also important to put C1, the bypass capacitor for the  $INTV_{CC}$  pin as close as possible between  $INTV_{CC}$  and GND.

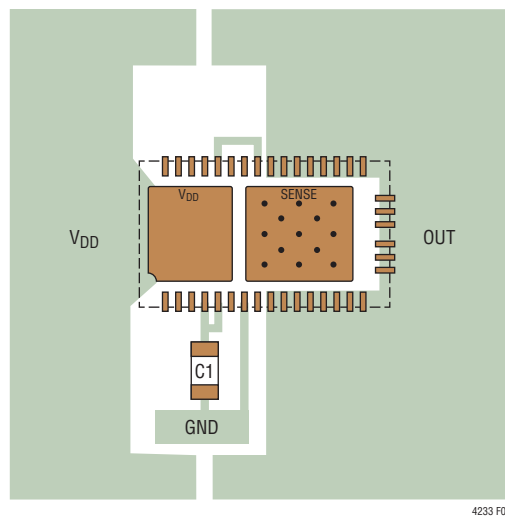

Figure 6. Recommended Layout



## APPLICATIONS INFORMATION

### Thermal Considerations

The LTC4233 junction to board temperature rise in still air when the load current is 5A, 7.5A and 10A is shown in curves of Figures 7 and 8. The junction temperature was measured at the package and the board temperature was measured at the board edge. This temperature rise falls as the board area is increases from 6.45 cm<sup>2</sup> to 103 cm<sup>2</sup>. Two different SENSE pad areas are shown as separate figures.

This thermal test board uses 2oz copper on the top layer divided equally between V<sub>DD</sub> and OUT traces similar to Figure 6. The second layer is 1oz copper connected to the vias to the SENSE pad on the top layer. Two versions of the second layer are considered. One uses a minimum

sized SENSE pad that only covers the vias for the top layer while the remainder of the second layer is empty (see Figure 7). The other version fills the second layer with SENSE connected copper (see Figure 8). The third layer is 1oz copper tied to ground while the bottom layer is 2oz copper tied to ground except for a few signal traces.

The curves demonstrate that the heat from the MOSFET can be effectively transferred out of the package through the OUT pins and only requires a minimum sized SENSE pad under the package. However for small boards the larger SENSE area does reduce the junction temperature when sourcing higher currents.

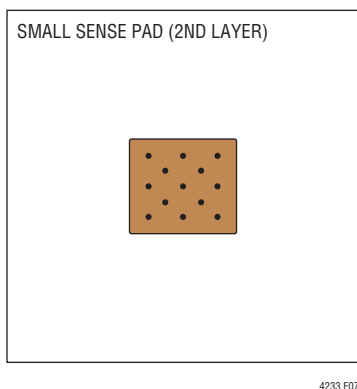
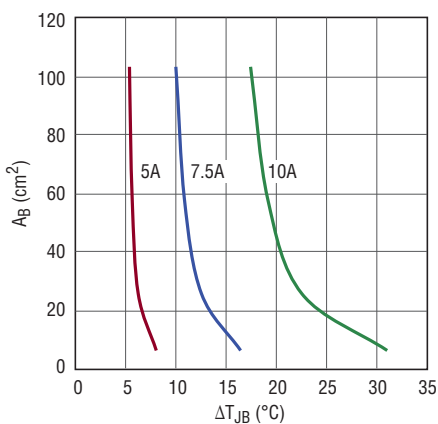

Figure 7. Temperature Rise for Small SENSE Pad

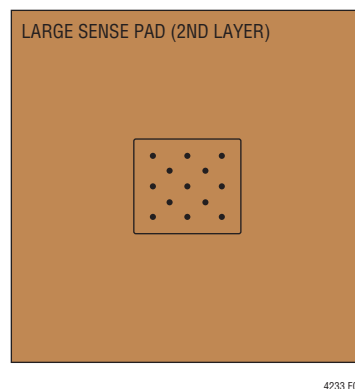
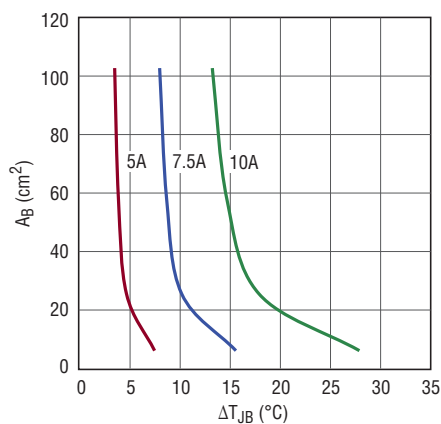

Figure 8. Temperature Rise for Large SENSE Pad

## APPLICATIONS INFORMATION

### Additional Applications

The LTC4233 has a wide operating range from 2.9V to 15V. The UV, OV and PG thresholds are set with few resistors. All other functions are independent of supply voltage.

In addition to Hot Swap applications, the LTC4233 also functions as a backplane resident switch for removable load cards (see Figure 9).

Figure 10 shows a 3.3V application with a UV threshold of 2.87V, an OV threshold of 3.77V and a PG threshold of 3.05V.

The last page shows a 20A parallel application where the two LTC4233 parts each provide 10A to the load. The PNPs prevent one LTC4233 from faulting off in current limit until both parts hit the 11.2A limit. The PNPs are disconnected when power good is false via the series MOSFETs M1 and M2.

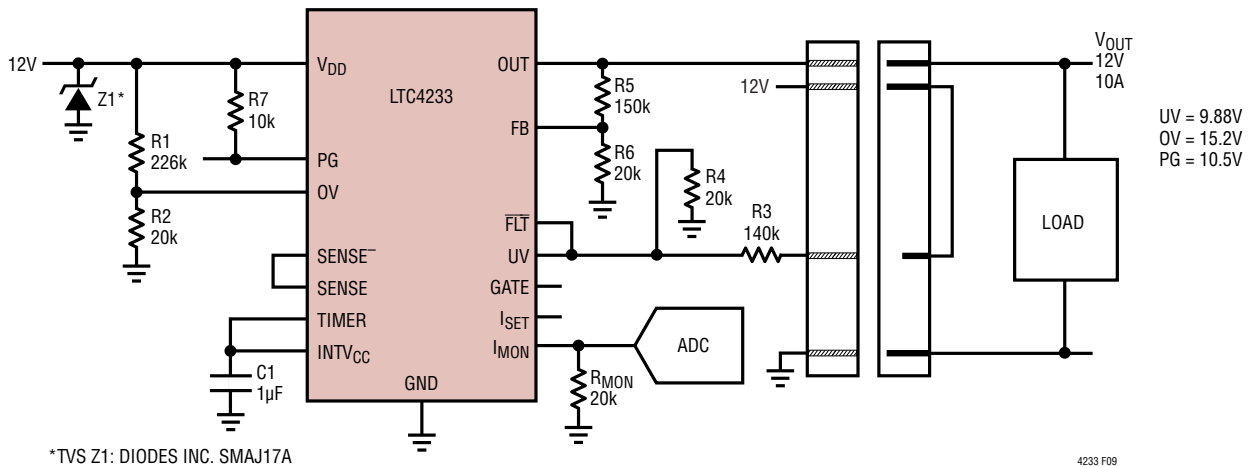

Figure 9. 12V, 10A Backplane Resident Application with Insertion Activated Turn-On

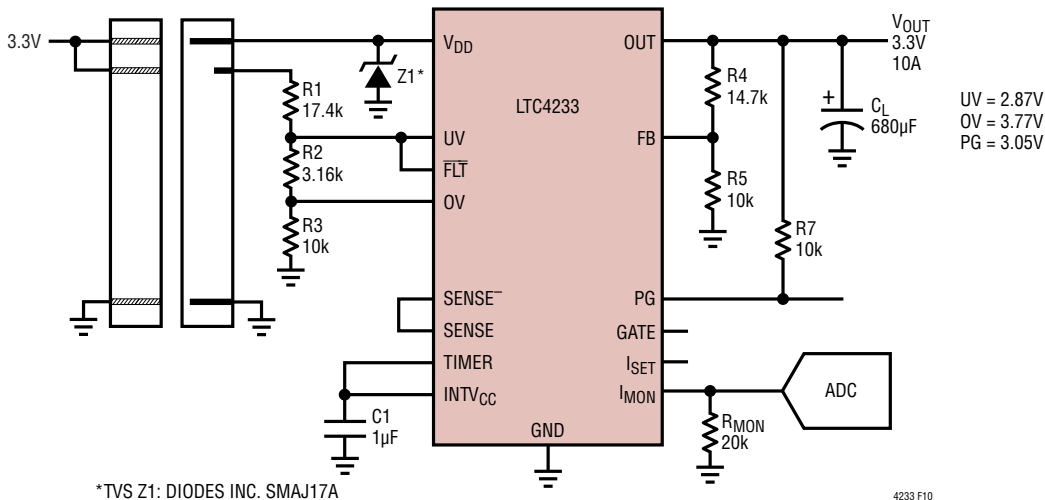
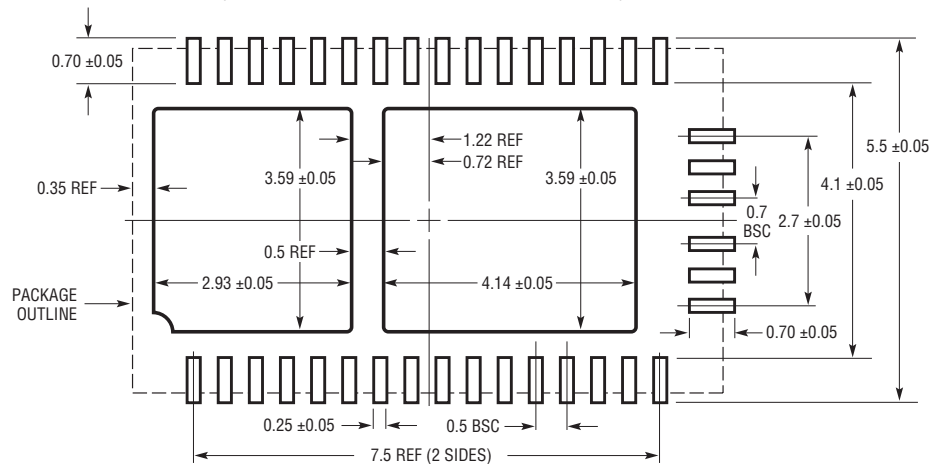

Figure 10. 3.3V, 10A Card Resident Application with Auto-Retry

# PACKAGE DESCRIPTION

Please refer to <http://www.linear.com/designtools/packaging/> for the most recent package drawings.

**WHH Package**  
**Variation: WHH38MA**  
**38-Lead Plastic QFN (5mm × 9mm)**  
 (Reference LTC DWG # 05-08-1934 Rev 0)



RECOMMENDED SOLDER PAD PITCH AND DIMENSIONS  
 APPLY SOLDER MASK TO AREAS THAT ARE NOT SOLDERED

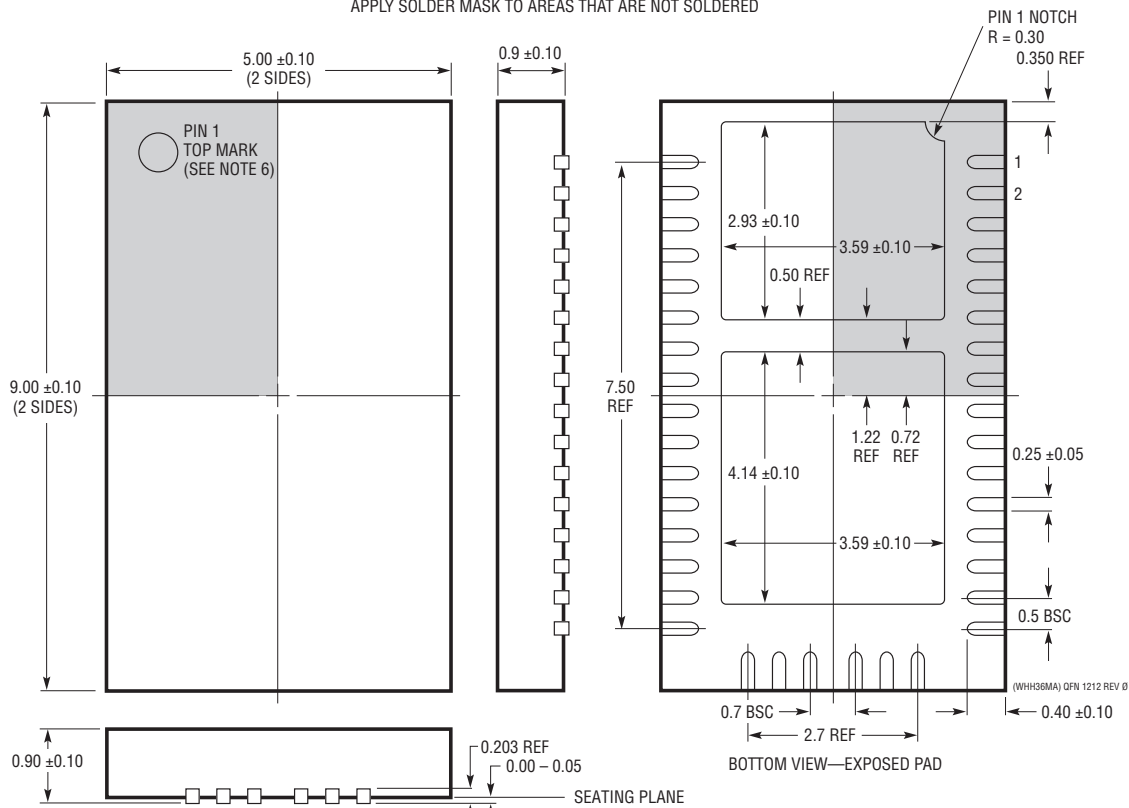

- NOTE:
1. DRAWING IS NOT A JEDEC PACKAGE OUTLINE
  2. DRAWING NOT TO SCALE
  3. ALL DIMENSIONS ARE IN MILLIMETERS
  4. DIMENSIONS OF EXPOSED PAD ON BOTTOM OF PACKAGE DO NOT INCLUDE MOLD FLASH. MOLD FLASH, IF PRESENT, SHALL NOT EXCEED 0.20mm ON ANY SIDE
  5. EXPOSED PAD SHALL BE SOLDER PLATED
  6. SHADED AREA IS ONLY A REFERENCE FOR PIN 1 LOCATION ON THE TOP AND BOTTOM OF PACKAGE