

## FEATURES

- Allows Safe Board Insertion and Removal from a Live PCI Slot
- Controls 3.3V, 5V, -12V, 12V and 3.3V Auxiliary Supplies
- Independent 3.3V Auxiliary Supply Hot Swap™ Controller
- Adjustable Foldback Current Limit with Circuit Breaker
- Adjustable Supply Voltage Power-Up Rate
- High Side Drive for External N-Channel FETs
- -12V and 12V On-Chip Switches
- Fault and Power Good Outputs

## APPLICATIONS

- PCI-Based Servers
- Computer Systems

LT, LTC and LT are registered trademarks of Linear Technology Corporation.  
Hot Swap is a trademark of Linear Technology Corporation.

## DESCRIPTION

The LTC<sup>®</sup>4241 is a Hot Swap controller that allows a board to be safely inserted and removed from a live PCI-bus slot. It has a primary controller that controls the four PCI supplies and an independent auxiliary controller to control the 3.3V auxiliary supply. External N-channel transistors are used to control the 3.3V, 5V and 3.3V auxiliary supplies while on-chip switches control the -12V and 12V supplies. The 3.3V, 5V and 3.3V auxiliary supplies can be ramped up at an adjustable rate. Electronic circuit breakers protect all five supplies against overcurrent faults. The PWRGD output of the primary controller indicates when all four PCI supplies are within tolerance. The FAULT output indicates an overcurrent condition for any of the five supplies.

The LTC4241 is available in the 20-pin narrow SSOP package.

## TYPICAL APPLICATION

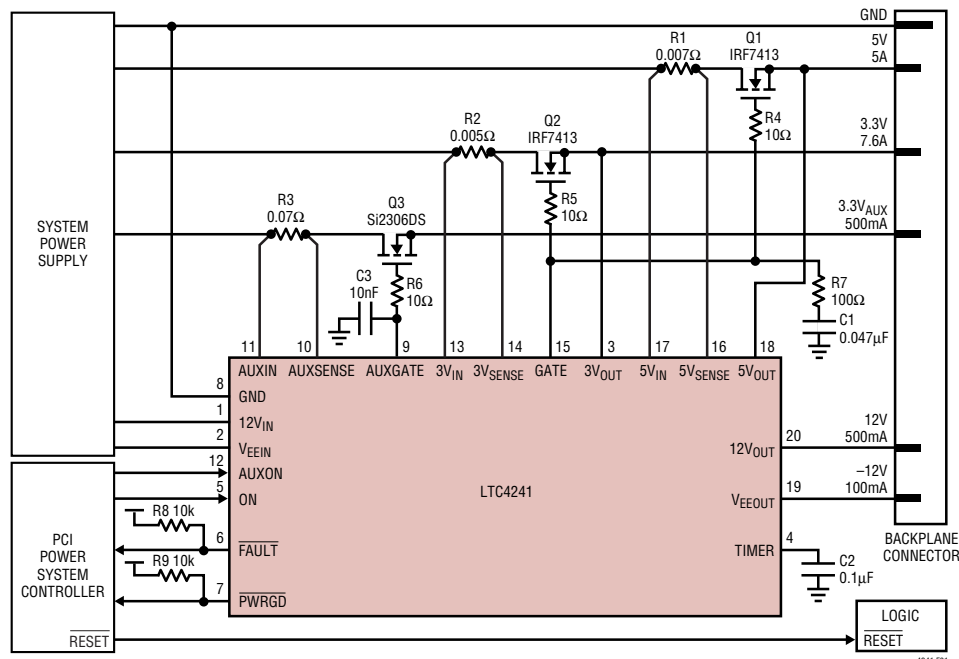

Figure 1. Hot Swappable PCI and 3.3V Auxiliary Supplies

## ABSOLUTE MAXIMUM RATINGS

(Note 1)

### Supply Voltages

12V <sub>IN</sub> .....	14V
V <sub>EEIN</sub> .....	-14V
AUXIN .....	7V

### Input Voltage

ON .....	-0.3V to 14V
AUXON .....	-0.3V to 14V

### Output Voltages

(FAULT, PWRGD) .....	-0.3V to 14V
----------------------	--------------

### Analog Voltages

TIMER, 3V <sub>IN</sub> , 3V <sub>SENSE</sub> , GATE, 5V <sub>SENSE</sub> , 5V <sub>IN</sub> .....	-0.3V to (12V <sub>IN</sub> + 0.3V)
3V <sub>OUT</sub> , 5V <sub>OUT</sub> .....	-0.3V to 14V
AUXSENSE .....	-0.3V to (AUXIN + 0.3V)
V <sub>EEOUT</sub> .....	-14V to + 0.3V
12V <sub>OUT</sub> .....	-0.3V to 14V
AUXGATE .....	Internally Limited (Note 3)

### Operating Temperature Range

LTC4241CGN .....	0°C to 70°C
LTC4241IGN .....	-40°C to 85°C

### Storage Temperature Range .....

.....	-65°C to 150°C
-------	----------------

### Lead Temperature (Soldering, 10sec) .....

.....	300°C
-------	-------

## PACKAGE/ORDER INFORMATION

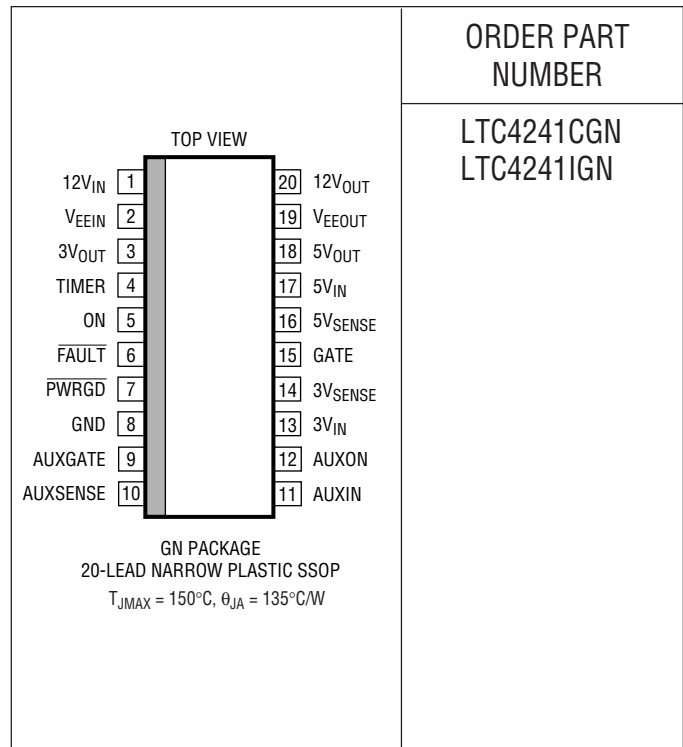

ORDER PART  
NUMBER

LTC4241CGN  
LTC4241IGN

Consult LTC Marketing for parts specified with wider operating temperature ranges.

## DC ELECTRICAL CHARACTERISTICS

The ● denotes the specifications which apply over the full operating temperature range, otherwise specifications are at T<sub>A</sub> = 25°C. V<sub>12VIN</sub> = 12V, V<sub>VEEIN</sub> = -12V, V<sub>3VIN</sub> = 3.3V, V<sub>5VIN</sub> = 5V, V<sub>AUXIN</sub> = 3.3V. (Note 2)

SYMBOL	PARAMETER	CONDITIONS	MIN	TYP	MAX	UNITS	
I <sub>DD</sub>	V <sub>12VIN</sub> Supply Current	ON = V <sub>12VIN</sub>	●	2.5	8	mA	
	V <sub>AUXIN</sub> Supply Current	AUXON = V <sub>AUXIN</sub>	●	0.5	1.5		
V <sub>LKO</sub>	Undervoltage Lockout, Low-to-High Transition	12V <sub>IN</sub>	●	6.5	9	10.8	V
		3V <sub>IN</sub>	●	2.25	2.50	2.75	V
		5V <sub>IN</sub>	●	3.65	3.90	4.15	V
		AUXIN	●	2.35	2.60	2.85	V
V <sub>LKH</sub>	Undervoltage Lockout Hysteresis	3V <sub>IN</sub> , 5V <sub>IN</sub>		20		mV	
		AUXIN		120		mV	
V <sub>SENSE5(TH)</sub>	Current Limit Sense Voltage Threshold (V <sub>5VIN</sub> - V <sub>5VSENSE</sub> )	V <sub>5VOUT</sub> = 0V	●	5.5	9	14.5	mV
		V <sub>5VOUT</sub> > 4V	●	40	55	70	mV
V <sub>SENSE3(TH)</sub>	Current Limit Sense Voltage Threshold (V <sub>3VIN</sub> - V <sub>3VSENSE</sub> )	V <sub>3VOUT</sub> = 0V	●	5.5	9	14.5	mV
		V <sub>3VOUT</sub> > 2V	●	40	55	70	mV
t <sub>CB</sub>	Circuit Breaker Trip Filter Time	(V <sub>5VIN</sub> - V <sub>5VSENSE</sub> ) = Step 0 to 100mV		17		μs	
		(V <sub>AUXIN</sub> - V <sub>AUXSENSE</sub> ) = Step 0 to 100mV		8		μs	
I <sub>GATE</sub>	GATE Pin Output Current	ON High, FAULT High, V <sub>GATE</sub> = GND	●	-20	-60	-100	μA
		ON Low, FAULT High, V <sub>GATE</sub> = 5V			200		μA
		ON High, FAULT Low, V <sub>GATE</sub> = 5V		5	25	35	mA

## DC ELECTRICAL CHARACTERISTICS

The ● denotes the specifications which apply over the full operating temperature range, otherwise specifications are at  $T_A = 25^\circ\text{C}$ .  $V_{12VIN} = 12\text{V}$ ,  $V_{VEEIN} = -12\text{V}$ ,  $V_{3VIN} = 3.3\text{V}$ ,  $V_{5VIN} = 5\text{V}$ ,  $V_{AUXIN} = 3.3\text{V}$ . (Note 2)

SYMBOL	PARAMETER	CONDITIONS	MIN	TYP	MAX	UNITS	
$\Delta V_{GATE}$	External Gate Voltage	$(V_{12VIN} - V_{GATE})$	●	100	200	mV	
$V_{DROP}$	Internal Switch Voltage Drop	$(V_{12VIN} - V_{12VOUT})$ , $I_{12VOUT} = 500\text{mA}$ $(V_{EEOUT} - V_{VEEIN})$ , $I_{VEEIN} = 100\text{mA}$	● ●	200 120	600 250	mV mV	
$I_{CL(12)}$	Current Limit	$12V_{IN} = 12\text{V}$ , $12V_{OUT} = 0\text{V}$ , $TIMER = GND$ $12V_{IN} = 12\text{V}$ , $12V_{OUT} = 11\text{V}$ , $TIMER = GND$	● ●	-50 -525	-300 -850	-575 -1500	mA mA
$I_{CL(VEE)}$	Current Limit	$V_{EEIN} = -12\text{V}$ , $V_{EEOUT} = 0\text{V}$ , $TIMER = GND$ $V_{EEIN} = -12\text{V}$ , $V_{EEOUT} = -11\text{V}$ , $TIMER = GND$	● ●	50 250	200 450	425 750	mA mA
$T_{TS}$	Thermal Shutdown Temperature			150		$^\circ\text{C}$	
$V_{PG(TH)}$	Power Good Threshold Voltage	$V_{12VOUT}$ Rising $V_{VEEOUT}$ Falling $V_{3VOUT}$ Rising $V_{5VOUT}$ Rising	● ● ● ●	10.8 -10.2 2.8 4.5	11.1 -10.5 2.9 4.65	11.4 -10.8 3.0 4.78	V V V V
$V_{PGH}$	Power Good Hysteresis	$3V_{OUT}$ $5V_{OUT}$ $12V_{OUT}$ , $V_{EEOUT}$			20 30 50	mV mV mV	
$V_{IL}$	Input Low Voltage	ON, AUXON	●		0.8	V	
$V_{IH}$	Input High Voltage	ON, AUXON	●	2		V	
$V_{OL}$	Output Low Voltage	FAULT, PWRGD, $I_{OL} = 3\text{mA}$	●		0.4	V	
$I_{IN}$	AUXON Pin Input Current	AUXON = GND AUXON = $V_{AUXIN}$	● ●		$\pm 0.08$ $\pm 0.08$	$\pm 10$ $\pm 10$	$\mu\text{A}$ $\mu\text{A}$
	ON Pin Input Current	ON = GND ON = $V_{12VIN}$	● ●		$\pm 0.08$ $\pm 0.08$	$\pm 10$ $\pm 10$	$\mu\text{A}$ $\mu\text{A}$
	$5V_{SENSE}$ Input Current	$5V_{SENSE} = 5\text{V}$	●		50	100	$\mu\text{A}$
	$3V_{SENSE}$ Input Current	$3V_{SENSE} = 3\text{V}$	●		50	100	$\mu\text{A}$
	$5V_{IN}$ Input Current	$5V_{IN} = 5\text{V}$	●		580	900	$\mu\text{A}$
	$3V_{IN}$ Input Current	$3V_{IN} = 3\text{V}$	●		310	550	$\mu\text{A}$
	$5V_{OUT}$ Input Current	$5V_{OUT} = 5\text{V}$ , ON = $V_{12VIN}$	●		260	500	$\mu\text{A}$
	$3V_{OUT}$ Input Current	$3V_{OUT} = 3\text{V}$ , ON = $V_{12VIN}$	●		150	350	$\mu\text{A}$
$R_{DIS}$	$5V_{OUT}$ Discharge Impedance $3V_{OUT}$ Discharge Impedance $12V_{OUT}$ Discharge Impedance $V_{EEOUT}$ Discharge Impedance	ON = GND ON = GND ON = GND ON = GND			60 50 450 1600	$\Omega$ $\Omega$ $\Omega$ $\Omega$	
$I_{TIMER}$	TIMER Pin Current	Timer On, $V_{TIMER} = GND$ , Timer Off, $V_{TIMER} = 5\text{V}$ ,	●	-15	-22 45	-27	$\mu\text{A}$ mA
$V_{TIMER}$	TIMER Threshold Voltage ( $V_{12VIN} - V_{TIMER}$ )		●	0.5	0.9	1.3	V
$V_{AUXCB}$	Circuit Breaker Trip Voltage ( $V_{AUXIN} - V_{AUXSENSE}$ )		●	40	50	60	mV
$I_{AUXGATE}$	AUXGATE Gate Output Current	AUXON High, FAULT High, $V_{AUXGATE} = GND$ AUXON Low, FAULT High, $V_{AUXGATE} = 5\text{V}$ AUXON High, FAULT Low, $V_{AUXGATE} = 10\text{V}$	●	-6	-10 200 50	-14	$\mu\text{A}$ $\mu\text{A}$ mA
$\Delta V_{AUXGATE}$	External AUXGATE Gate Voltage	$(V_{AUXGATE} - V_{AUXIN})$ , $V_{AUXIN} = 3.3\text{V}$	●	5	8	11	V

**Note 1:** Absolute Maximum Ratings are those values beyond which the life of a device may be impaired.

**Note 2:** All currents into device pins are positive; all currents out of device pins are negative. All voltages are referenced to ground unless otherwise specified.

**Note 3:** An internal zener on the AUXGATE pin clamps the charge pump voltage to a typical maximum operating voltage of 12V. External overdrive of the AUXGATE pin beyond the internal zener voltage may damage the device.

## TYPICAL PERFORMANCE CHARACTERISTICS

**3.3V and 5V Current Foldback Profile**

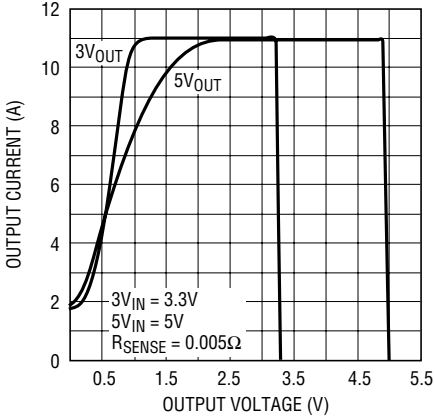

4241 • G01

**12V Current Foldback Profile**

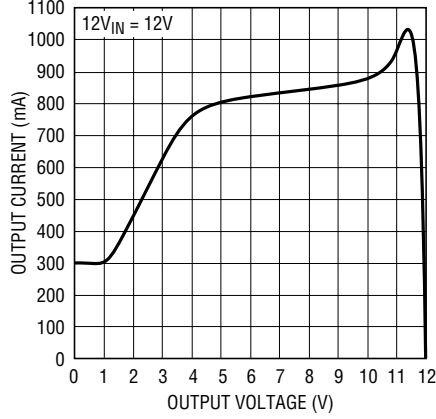

4241 • G02

**-12V Current Foldback Profile**

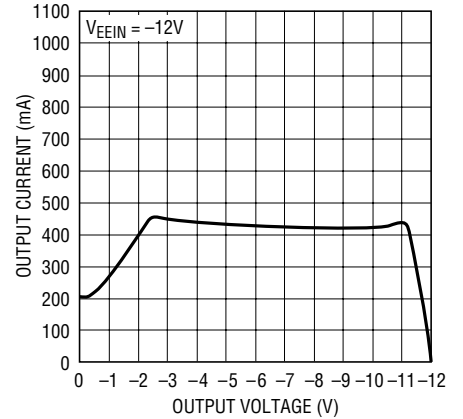

4241 • G03

**5V<sub>IN</sub> Current Limit Voltage vs Temperature**

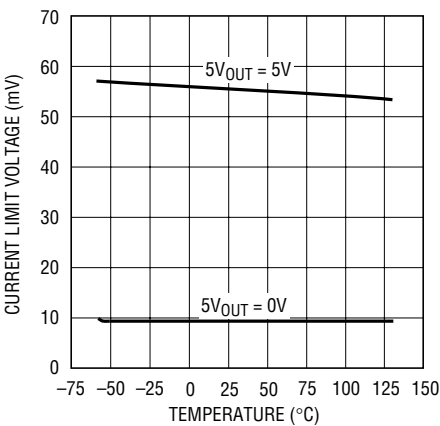

4241 • G04

**3V<sub>IN</sub> Current Limit Voltage vs Temperature**

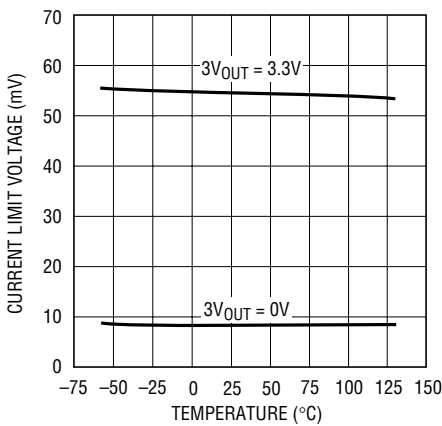

4241 • G05

**12V<sub>IN</sub> Current Limit vs Temperature**

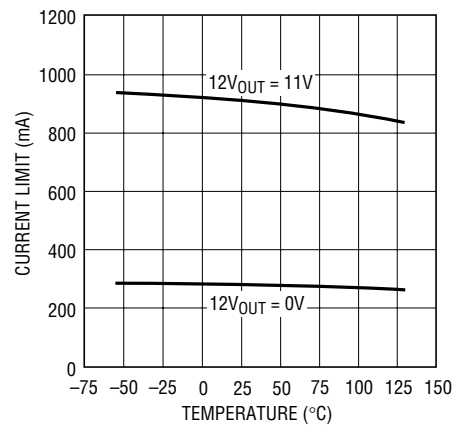

4241 • G06

**V<sub>EEIN</sub> Current Limit vs Temperature**

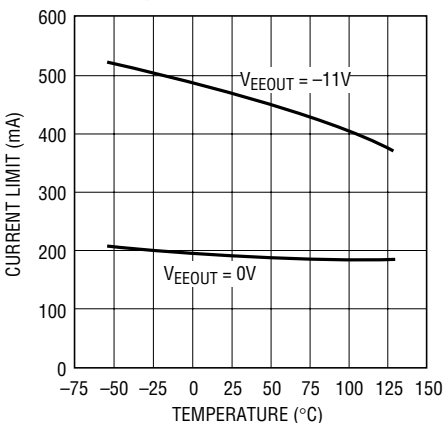

4241 • G07

**(V<sub>AUXIN</sub> - V<sub>AUXSENSE</sub>) Circuit Breaker Trip Voltage vs Temperature**

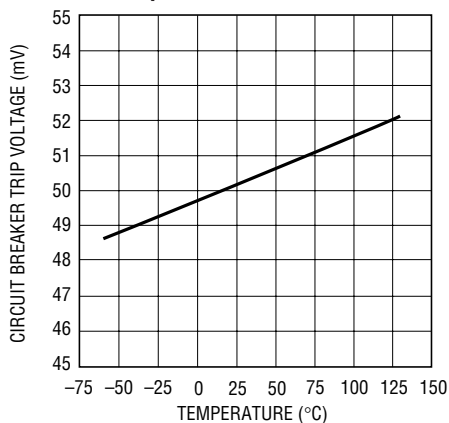

4241 • G08

**GATE, AUXGATE Output Source Current vs Temperature**

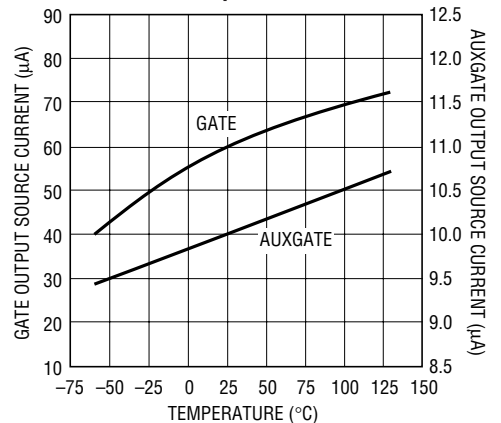

4241 • G09

# TYPICAL PERFORMANCE CHARACTERISTICS

**GATE, AUXGATE Output Sink Current vs Temperature**

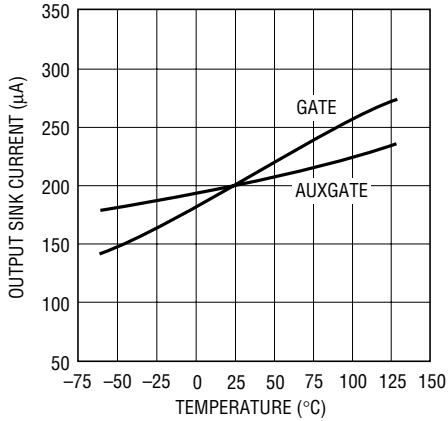

4241 • G10

**GATE, AUXGATE Fast Pull-Down Current vs Temperature**

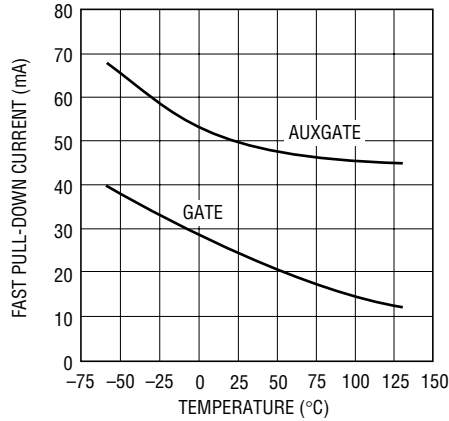

4241 • G11

**(V<sub>AUXGATE</sub> - V<sub>AUXIN</sub>) vs Temperature**

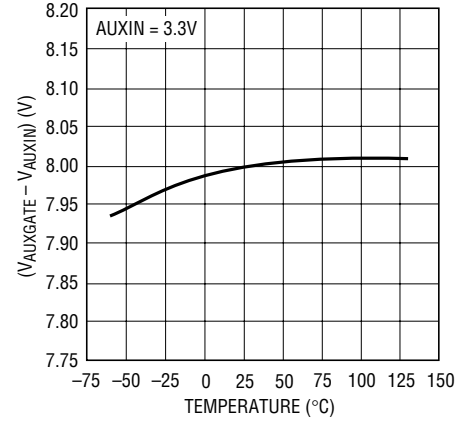

4241 • G12

**AUXGATE Voltage vs Temperature**

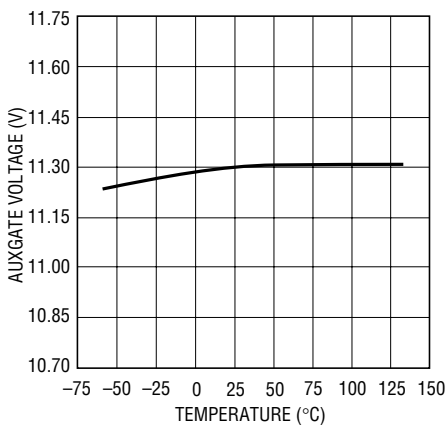

4241 • G13

**12V Internal Switch Voltage Drop vs Temperature**

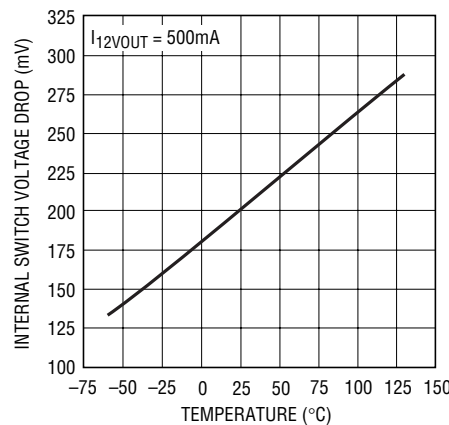

4241 • G14

**V<sub>EE</sub> Internal Switch Voltage Drop vs Temperature**

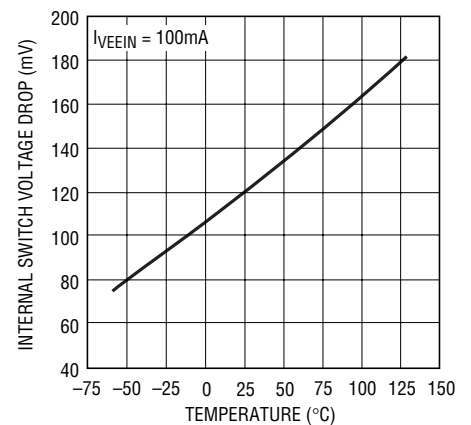

4241 • G15

**Power Good Threshold Voltage vs Temperature (12V<sub>OUT</sub>)**

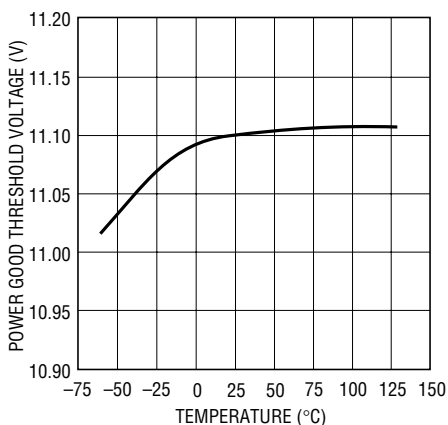

4241 • G16

**Power Good Threshold Voltage vs Temperature (5V<sub>OUT</sub>)**

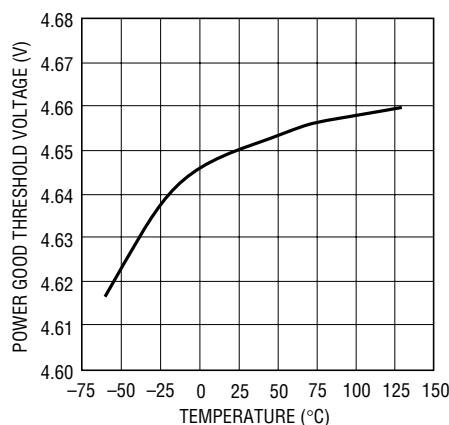

4241 • G17

**Power Good Threshold Voltage vs Temperature (3V<sub>OUT</sub>)**

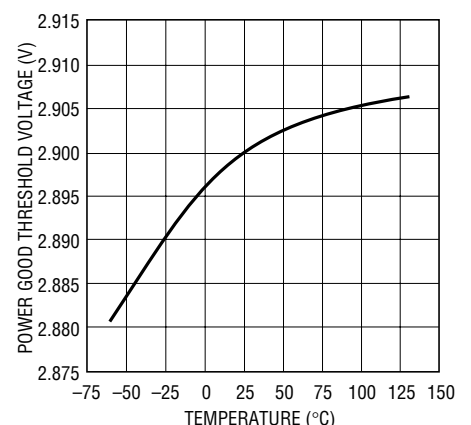

4241 • G18

## TYPICAL PERFORMANCE CHARACTERISTICS

**Power Good Threshold Voltage vs Temperature ( $V_{EEOUT}$ )**

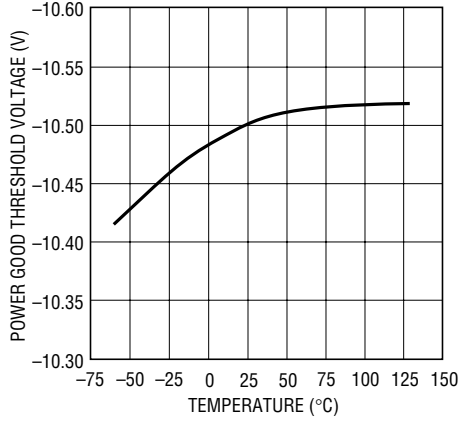

4241 • G19

**Timer Threshold Voltage vs Temperature**

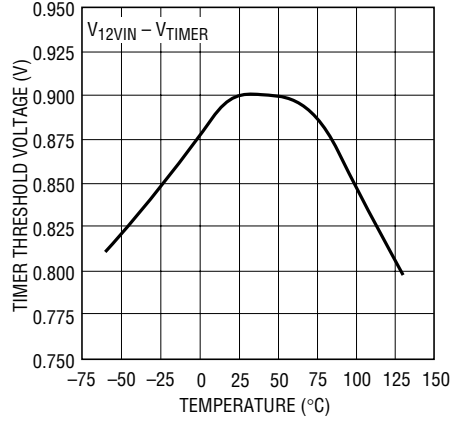

4241 • G20

**Timer Current vs Temperature**

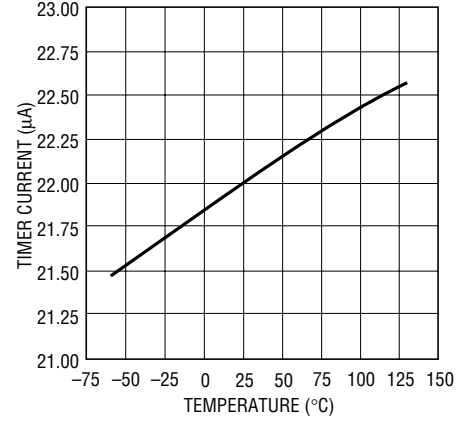

4241 • G21

**12V<sub>IN</sub> Supply Current vs Temperature**

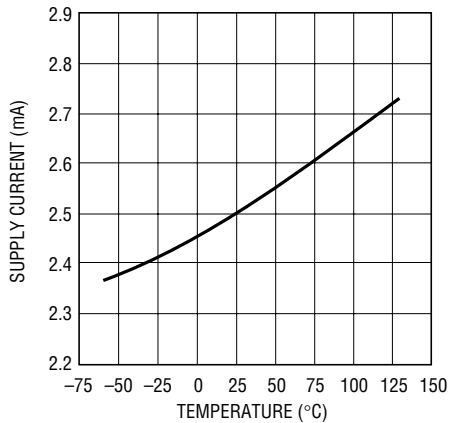

4241 • G22

**$V_{EEIN}$ , 5V<sub>IN</sub>, 3V<sub>IN</sub>, AUXIN Supply Current vs Temperature**

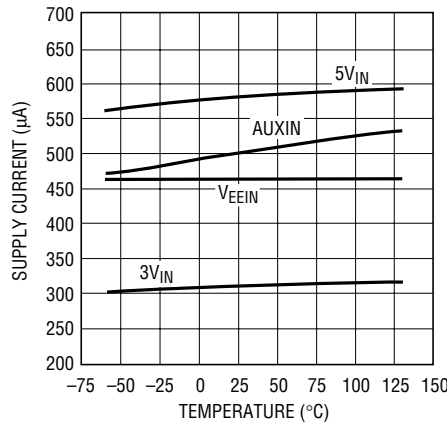

4241 • G23

**12V<sub>IN</sub> Undervoltage Lockout Threshold vs Temperature**

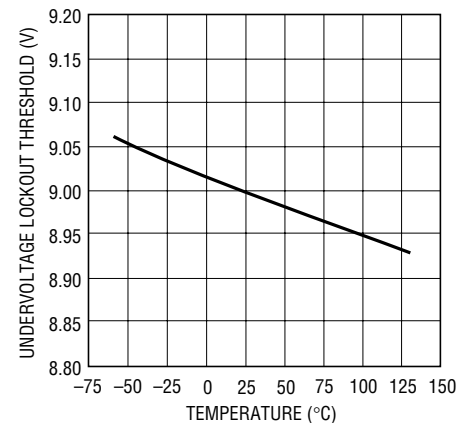

4241 • G24

**5V<sub>IN</sub> Undervoltage Lockout Threshold vs Temperature**

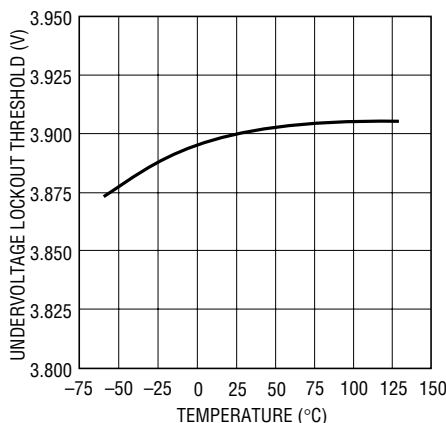

4241 • G25

**3V<sub>IN</sub>, AUXIN Undervoltage Lockout Threshold vs Temperature**

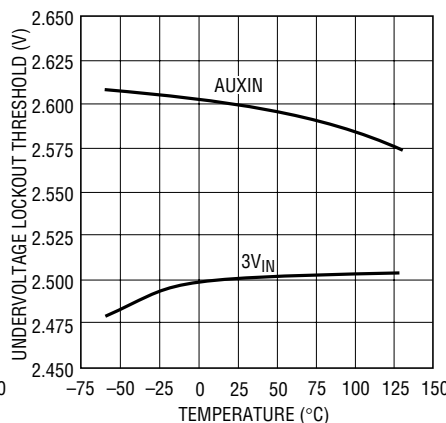

4241 • G26

**( $V_{5VIN} - V_{5VSENSE}$ ), ( $V_{AUXIN} - V_{AUXSENSE}$ ) Circuit Breaker Trip Filter Time vs Temperature**

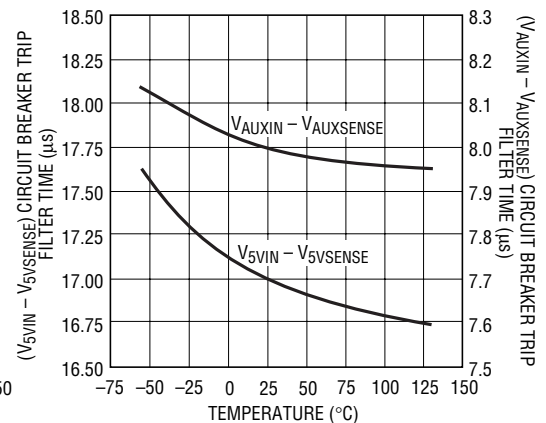

4241 • G27

## PIN FUNCTIONS

**12V<sub>IN</sub> (Pin 1):** 12V Supply Input. This pin powers the primary controller internal circuitry. A 0.5Ω switch is connected between 12V<sub>IN</sub> and 12V<sub>OUT</sub> with a foldback current limit. An undervoltage lockout circuit prevents the switches from turning on while the 12V<sub>IN</sub> pin voltage is less than 9V.

**V<sub>EEIN</sub> (Pin 2):** -12V Supply Input. A 1.2Ω switch is connected between V<sub>EEIN</sub> and V<sub>EEOUT</sub> with a foldback current limit.

**3V<sub>OUT</sub> (Pin 3):** 3.3V Output Monitor. Used to monitor the 3.3V output supply voltage. The  $\overline{\text{PWRGD}}$  signal cannot go low until the 3V<sub>OUT</sub> pin exceeds 2.9V.

**TIMER (Pin 4):** Current Limit Fault Timer Input. Connect a capacitor from TIMER to ground. With the primary controller turned off (ON = GND) or the internal circuit breaker tripped due to a PCI supply fault ( $\overline{\text{FAULT}} = \text{low}$ ), the TIMER pin is internally held at ground. When the primary controller is turned on, a 22μA pull-up current source is connected to TIMER. Current limit faults from the PCI supplies will be ignored until the voltage at the TIMER pin rises to within 0.9V of 12V<sub>IN</sub>.

**ON (Pin 5):** On Control Input. A rising edge turns on the external N-channel FETs for 3.3V and 5V PCI supplies, the internal 12V and -12V switches and a falling edge turns it off. If the ON pin is cycled low then high following the trip of the circuit breaker due to a PCI supply fault, the circuit breaker is reset.

**FAULT (Pin 6):** Fault Output. Open drain logic output used by both the primary and auxiliary controller to indicate an overcurrent fault condition. When any of the PCI and 3.3V auxiliary supplies are in current limit fault, the controller detecting the fault (primary or auxiliary) will be latched off and the FAULT pin will be pulled low. Current limit faults from the PCI supplies are ignored while the voltage at the TIMER pin is less than (12V<sub>IN</sub> - 0.9V). The current limit fault detected by the primary controller will not cause the auxiliary controller to latch off and vice versa.

**PWRGD (Pin 7):** Power Good Output. Open drain logic output used by the primary controller to indicate the voltage status of the PCI supplies. PWRGD remains low while V<sub>12VOUT</sub> ≥ 11.1V, V<sub>3VOUT</sub> ≥ 2.9V, V<sub>5VOUT</sub> ≥ 4.65V, V<sub>V<sub>EEOUT</sub></sub> ≤ -10.5V. When one of the supplies falls below its

power good threshold voltage,  $\overline{\text{PWRGD}}$  will go high after a 15μs deglitching time. The switches will not be turned off when  $\overline{\text{PWRGD}}$  goes high.

**GND (Pin 8):** Chip Ground

**AUXGATE (Pin 9):** High Side Gate Drive for the 3.3V Auxiliary External N-channel MOSFET. An internal charge pump generates at least 8V of gate drive from a 3.3V auxiliary supply. A zener clamps AUXGATE approximately 12V above the supply voltage at AUXIN. The rise time at AUXGATE is set by an external AUXGATE capacitor connected to ground and an internal 10μA current source provided by the charge pump. If the circuit breaker trips or the auxiliary supply voltage hits the undervoltage lockout threshold, a 50mA current sink rapidly pulls AUXGATE low.

**AUXSENSE (Pin 10):** 3.3V Auxiliary Circuit Breaker Current Sense Input. The load current is monitored by a sense resistor connected between AUXIN and AUXSENSE. The circuit breaker trips if the voltage across the sense resistor exceeds 50mV and the AUXGATE pin voltage will be turned off.

**AUXIN (Pin 11):** 3.3V Auxiliary Supply Input. This pin powers the auxiliary controller internal circuitry. An undervoltage lockout circuit disables the AUXGATE pin until the supply voltage at AUXIN is greater than 2.6V. AUXGATE is held at ground potential until the undervoltage lockout deactivates. If no 3.3V auxiliary supply is available, tie AUXIN to ground.

**AUXON (Pin 12):** ON Control Input for Auxiliary Supply. A rising edge turns on the external N-channel FET for 3.3V auxiliary supply and a falling edge turns it off. If the AUXON pin is cycled low then high following the trip of the circuit breaker due to a 3.3V auxiliary supply fault, the circuit breaker is reset.

**3V<sub>IN</sub> (Pin 13):** 3.3V Supply Sense Input. An undervoltage lockout circuit prevents the switches from turning on when the voltage at the 3V<sub>IN</sub> pin is less than 2.5V. If no 3.3V input supply is available, tie 3V<sub>IN</sub> to the 5V<sub>IN</sub> pin.

**3V<sub>SENSE</sub> (Pin 14):** 3.3V Current Limit Set Pin. With a sense resistor placed in the supply path between 3V<sub>IN</sub> and 3V<sub>SENSE</sub>, the GATE pin voltage will be adjusted to maintain



## PIN FUNCTIONS

a constant voltage across the sense resistor and a constant current through the switch. A foldback feature makes the current limit decrease as the voltage at the  $3V_{OUT}$  pin approaches ground. To disable the current limit,  $3V_{SENSE}$  and  $3V_{IN}$  can be shorted together.

**GATE (Pin 15):** High Side Gate Drive for the 3.3V and 5V PCI Supplies External N-channel MOSFETs. Requires an external series RC network for the current limit loop compensation and setting the minimum ramp-up rate. During power-up, the slope of the voltage rise at the GATE is set by the internal  $60\mu\text{A}$  pull up current source and the external GATE capacitor connected to ground. During power-down, the slope of the falling voltage is set by the  $200\mu\text{A}$  current source connected to ground and the external GATE capacitor.

**$5V_{SENSE}$  (Pin 16):** 5V Current Limit Set Pin. With a sense resistor placed in the supply path between  $5V_{IN}$  and  $5V_{SENSE}$ , the GATE pin voltage will be adjusted to maintain a constant voltage across the sense resistor and a constant current through the switch. A foldback feature makes

the current limit decrease as the voltage at the  $5V_{OUT}$  pin approaches ground. To disable the current limit,  $5V_{SENSE}$  and  $5V_{IN}$  can be shorted together.

**$5V_{IN}$  (Pin 17):** 5V Supply Sense Input. Used to monitor the 5V input supply voltage. An undervoltage lockout circuit prevents the switches from turning on when the voltage at the  $5V_{IN}$  pin is less than 3.9V.

**$5V_{OUT}$  (Pin 18):** 5V Output Monitor. Used to monitor the 5V output supply voltage. The  $\overline{\text{PWRGD}}$  signal cannot go low until the  $5V_{OUT}$  pin exceeds 4.65V.

**$V_{EEOUT}$  (Pin 19):**  $-12\text{V}$  Supply Output. A  $1.2\Omega$  switch is connected between  $V_{EEIN}$  and  $V_{EEOUT}$ .  $V_{EEOUT}$  must fall below  $-10.5\text{V}$  before the  $\overline{\text{PWRGD}}$  signal can go low on the LTC4241.

**$12V_{OUT}$  (Pin 20):**  $12\text{V}$  Supply Output. A  $0.5\Omega$  switch is connected between  $12V_{IN}$  and  $12V_{OUT}$ .  $12V_{OUT}$  must exceed  $11.1\text{V}$  before the  $\overline{\text{PWRGD}}$  signal can go low on the LTC4241



**BLOCK DIAGRAM**

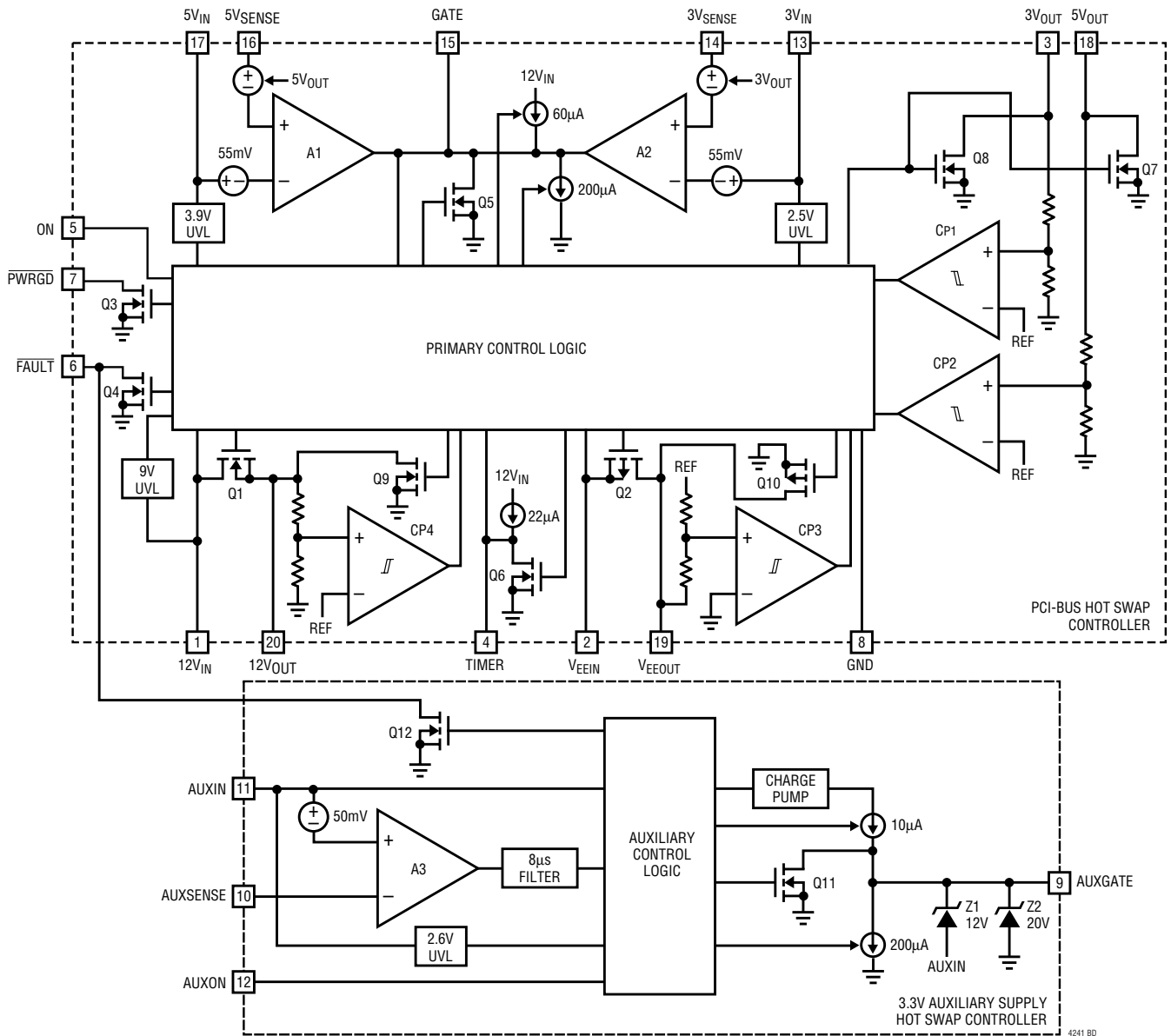

4241 BD

## APPLICATIONS INFORMATION

### Hot Circuit Insertion

When a circuit board is inserted into a live PCI slot, the supply bypass capacitors on the board can draw huge transient currents from the PCI power bus as they charge up. The transient currents can cause permanent damage to the connector pins and glitches the power bus, causing other boards in the system to reset.

The LTC4241 is designed to turn a board's supply voltages on and off in a controlled manner, allowing the board to be safely inserted or removed from a live PCI slot without glitching the system power supplies. The chip also protects the PCI supplies from shorts and monitors the supply voltages.

The LTC4241 is designed for motherboard applications and includes an additional independent controller for the 3.3V auxiliary supply.

### LTC4241 Feature Summary

1. Allows safe board insertion and removal from a motherboard.
2. Primary controller to control the four PCI supplies: 3.3V, 5V, -12V, 12V and an independent auxiliary controller to control the 3.3V auxiliary supply.
3. Adjustable foldback current limit for PCI supplies: an adjustable analog current limit with a value that depends on the output voltage. If the output is shorted to ground, the current limit drops to keep power dissipation and supply glitches to a minimum.
4. Electronic circuit breaker for all supplies: if a supply remains in current limit for too long, the circuit breaker will trip, the supplies will be turned off and the FAULT pin pulled low.
5. Current limit power-up: the four PCI supplies are allowed to power up in current limit. This allows the chip to power up boards with a wide range of capacitive loads without tripping the circuit breaker. The maximum allowable power-up time is programmable using the TIMER pin.
6. On-Chip -12V and 12V power switches
7. Power good output: monitors the voltage status of the four PCI supply voltages. The 3.3V auxiliary supply is not monitored.

8. Fault control: the current limit fault detected by either the primary or auxiliary controller will not cause the other controller to latch off. Both controllers use the FAULT output to indicate a fault condition.

9. Space saving 20-pin narrow SSOP package.

### PCI Power Requirements

PCI systems usually require four power rails: 5V, 3.3V, -12V and 12V. Systems implementing the 3.3V signaling environment are usually required to provide all four rails in every system.

A 3.3V auxiliary supply is added in the PCI system to power PCI logic functions that need to remain active when the rest of the system is unpowered.

The tolerance of the supplies as measured at the components is summarized in Table 1.

**Table 1. PCI Power Supply Requirements**

SUPPLY	TOLERANCE	CAPACITIVE LOAD
5V	5V ± 5%	<3000μF
3.3V	3.3V ± 0.3V	<3000μF
12V	12V ± 5%	<500μF
-12V	-12V ± 10%	<120μF
3.3V <sub>AUX</sub>	3.3V ± 0.3V	<500μF

### Power-Up Sequence for PCI Power Supplies

The PCI power supplies are controlled by placing external N-channel pass transistors in the 3.3V and 5V power paths, and internal pass transistors for the 12V and -12V power paths (Figure 1).

Resistors R1 and R2 provide a current signal for fault detection and R7 and C1 provide current control loop compensation. Resistors R4 and R5 prevent high frequency oscillations in Q1 and Q2.

When the ON pin is pulled high, the GATE pin is pulled high by an internal 60μA current source and the pass transistors are allowed to turn on. The internal 12V and -12V switches are also turned on and a 22μA current source is connected to the TIMER pin (Figure 2).

## APPLICATIONS INFORMATION

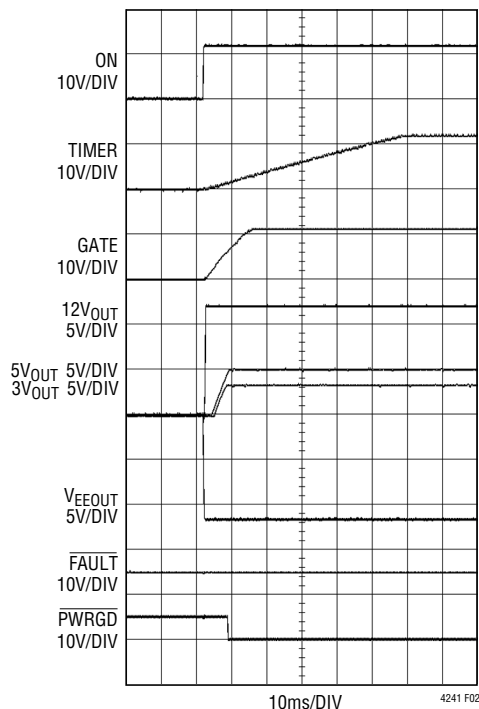

Figure 2. Normal Power-Up Sequence

The current in each pass transistor increases until it reaches the current limit for each supply. Each supply is allowed to power up at the rate  $dV/dt = 60\mu A/C1$  or as determined by the current limit and the load capacitance on the supply line, whichever is slower. Current limit faults are ignored while the TIMER pin voltage is ramping up and is less than 0.9V below  $12V_{IN}$ . Once all four PCI supply voltages are within tolerance, the  $\overline{PWRGD}$  pin will pull low.

## Power-Down Sequence for PCI Power Supplies

When the ON pin is pulled low, a power-down sequence begins for all the PCI power supplies (Figure 3).

Internal switches are connected to each of the output supply voltage pins to discharge the load capacitors to ground. The TIMER pin is immediately pulled low and the internal 12V and -12V switches are turned off. The GATE pin is pulled to ground by an internal  $200\mu A$  current source. This turns off the external pass transistors in a controlled manner and prevents the load current on the 3.3V and 5V supplies from going to zero instantaneously and glitching the power supply voltages. When any of the output voltages dips below its threshold, the  $\overline{PWRGD}$  pin pulls high.

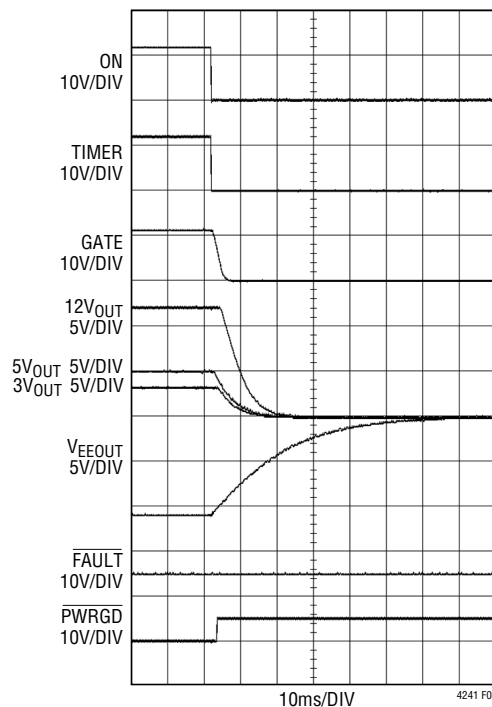

Figure 3. Normal Power-Down Sequence

## Timer

During a power-up sequence for the PCI power supplies, a  $22\mu A$  current source is connected to the TIMER pin and current limit faults are ignored until the voltage ramps to within 0.9V of  $12V_{IN}$ . This feature allows the chip to power up a PCI slot that can accommodate boards with a wide range of capacitive loads on the supplies. The power-up time for any one of the four outputs will be:

$$t_{ON} \cong 2 \cdot \left( \frac{C_{LOAD} \cdot V_{OUT}}{I_{LIMIT} - I_{LOAD}} \right)$$

For example, for  $C_{LOAD} = 2000\mu F$ ,  $V_{OUT} = 5V$ ,  $I_{LIMIT} = 7A$ ,  $I_{LOAD} = 5A$ , the  $5V_{OUT}$  turn-on time will be  $\sim 10ms$ . By substituting the variables in the above equation with the appropriate values, the turn-on time for the other three outputs can be calculated. The timer period should be set longer than the maximum supply turn-on time but short enough to not exceed the maximum safe operating area of the pass transistor during a short-circuit. The timer period is given by:

$$t_{TIMER} = \frac{C_{TIMER} \cdot 11.1V}{22\mu A}$$

## APPLICATIONS INFORMATION

For  $C_{\text{TIMER}} = 0.1\mu\text{F}$ , the timer period will be  $\sim 50\text{ms}$ . The  $\overline{\text{TIMER}}$  pin is immediately pulled low when  $\overline{\text{ON}}$  goes low.

### Thermal Shutdown

The internal switches for the 12V and  $-12\text{V}$  supplies are protected by an internal current limit and thermal shutdown circuit. When the temperature of the chip reaches  $150^\circ\text{C}$ , only the switches controlling the PCI supplies will be latched off and the  $\overline{\text{FAULT}}$  pin will be pulled low.

### Short-Circuit Protection for PCI Power Supplies

During a normal power-up sequence for the PCI power supplies, if the  $\overline{\text{TIMER}}$  is done ramping and any supply is still in current limit, all of the pass transistors will be immediately turned off, the  $\overline{\text{TIMER}}$  and  $\overline{\text{FAULT}}$  pin will be pulled low as shown in Figure 4.

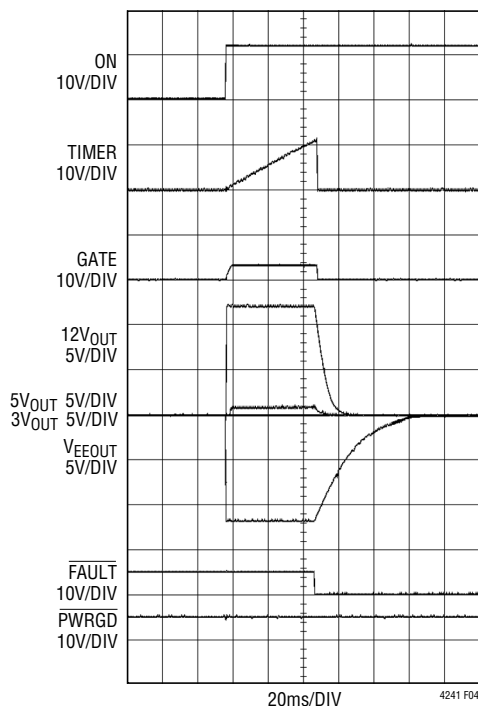

Figure 4. Power-Up into a Short on 3.3V Output

If a short-circuit occurs after the PCI supplies are powered up, the shorted supply's current will drop immediately to the limit value (Figure 5).

If the supply remains in current limit for more than  $17\mu\text{s}$ , all of the PCI supplies except the 3.3V auxiliary supply will be latched off. The  $17\mu\text{s}$  delay prevents quick current

spikes — for example, from a fan turning on — from causing false trips of the circuit breaker. The chip will stay in the latched-off state until the  $\overline{\text{ON}}$  pin is cycled low then high, or the  $12\text{V}_{\text{IN}}$  supply is cycled.

To prevent excessive power dissipation in the pass transistors and to prevent voltage spikes on the supplies during short-circuit conditions, the current limit on each PCI supply, except the 3.3V auxiliary supply, is designed to be a function of the output voltage. As the output voltage drops, the current limit decreases. Unlike a traditional circuit breaker function where huge currents can flow before the breaker trips, the current foldback feature assures that the supply current will be kept at a safe level and prevent voltage glitches when powering up into a short.

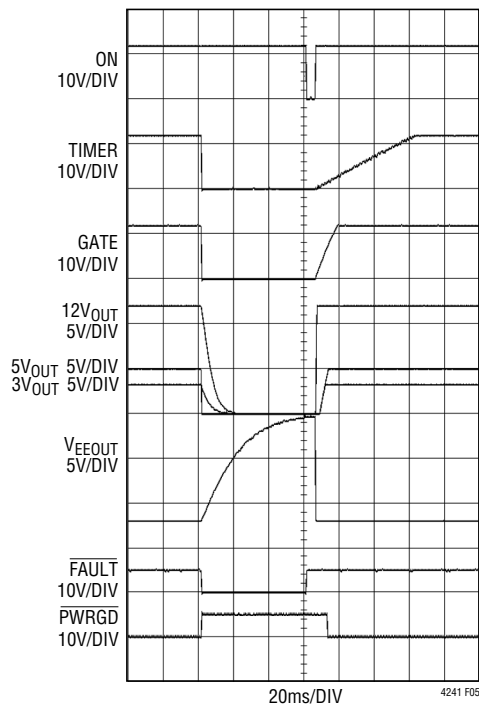

Figure 5. Short-Circuit on 5V Followed by Circuit Breaker Reset

The current limit and the foldback current level for the 5V and 3.3V outputs are both a function of the external sense resistor ( $R_1$  for  $5\text{V}_{\text{OUT}}$  and  $R_2$  for  $3\text{V}_{\text{OUT}}$ , see Figure 1). As shown in Figure 1, a sense resistor is connected between  $5\text{V}_{\text{IN}}$  and  $5\text{V}_{\text{SENSE}}$  for the 5V supply. For the 3V supply, a sense resistor is connected between  $3\text{V}_{\text{IN}}$  and  $3\text{V}_{\text{SENSE}}$ .

## APPLICATIONS INFORMATION

The current limit and the foldback current level (at the  $V_{OUT} = 0V$ ) are given by:

$$I_{LIMIT} = 55mV/R_{SENSE}$$

$$I_{FOLDBACK} = 9mV/R_{SENSE}$$

As a design aid, the current limit and foldback level for commonly used values for  $R_{SENSE}$  are given in Table 2.

**Table 2.  $I_{LIMIT}$  and  $I_{FOLDBACK}$  vs  $R_{SENSE}$**

$R_{SENSE}$ ( $\Omega$ )	$I_{LIMIT}$	$I_{FOLDBACK}$
0.005	11A	1.8A
0.006	9.2A	1.5A
0.007	7.9A	1.3A
0.008	6.9A	1.1A
0.009	6.1A	1.0A
0.01	5.5A	0.9A

The current limit for the internal 12V switch is set at 850mA folding back to 300mA and the -12V switch at 450mA folding back to 200mA.

In systems where it is possible to exceed the current limit for a short amount of time, it might be necessary to prevent the analog current loop from responding quickly so the output voltage does not droop. This can be accomplished by adding an RC filter across the sense resistor as shown in Figure 6.  $R_F$  should be  $20\Omega$  or less to prevent offset errors. A capacitor,  $C_F$ , of  $0.1\mu F$  gives a delay of about  $1.5\mu s$  and a  $1\mu F$  capacitor gives a delay of about  $15\mu s$ .

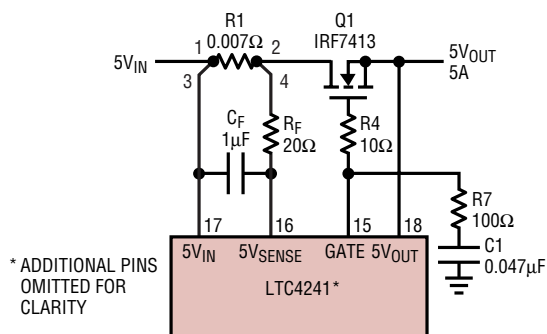

**Figure 6. Delay in the Current Limit Loop**

### Power-Up/Down Sequence for 3.3V Auxiliary Supply

The 3.3V auxiliary supply is controlled by placing an external N-channel pass transistor Q3 in the  $3.3V_{AUX}$

power path (Figure 1). The resistor R3 provides load current fault detection and R6 prevents high frequency oscillation in Q3.

When power is first applied to  $V_{AUXIN}$ , the AUXGATE pin pulls low. A low-to-high transition at the AUXON pin initiates the AUXGATE ramp up (Figure 7). The AUXGATE is pulled high by an internal  $10\mu A$  current source and the pass transistor is allowed to turn on. As the auxiliary controller does not have the foldback current limit feature and timer control, the inrush supply current during power-up is limited by ramping the gate of the pass transistor at a controlled rate ( $dV/dt = 10\mu A/C3$ ) where C3 is the total external capacitance between AUXGATE and ground. With proper selection of the C3 capacitance value, the inrush current ( $I = C_{LOAD} \cdot dV/dt = 10\mu A \cdot C_{LOAD}/C3$ ) is limited to a value less than the current limit set by the sense resistor R3. This prevents the circuit breaker from tripping during power-up.  $C_{LOAD}$  is the total load capacitance on the 3.3V auxiliary supply line. For example, for  $C3 = 10nF$ ,  $C_{LOAD} = 470\mu F$ ,  $R3 = 0.07\Omega$ ,  $I_{LIMIT} = 0.7A$ , the inrush current will be  $0.47A < I_{LIMIT}$ . The ramp-up time for  $3.3V_{AUX}$  output to reach its final value is equal to  $t = (V_{AUXIN} \cdot C3)/10\mu A$ .

A high-to-low transition at the AUXON pin initiates a AUXGATE ramp-down at a slope of  $-200\mu A/C3$  as the AUXGATE is pulled to ground by an internal  $200\mu A$  current source. This will allow the load capacitance on the supply line to discharge while the AUXGATE pulls low to turn off the external N-channel pass transistor.

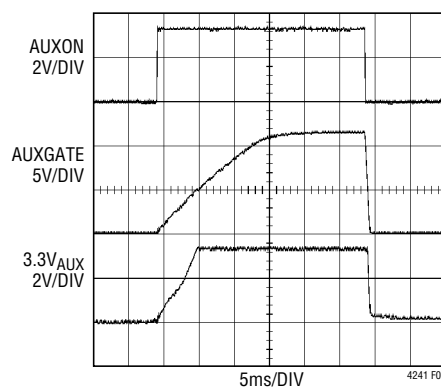

**Figure 7. Power-Up/Down Sequence for 3.3V Auxiliary Supply**

## APPLICATIONS INFORMATION

### Electronic Circuit Breaker for 3.3V Auxiliary Supply

An electronic circuit breaker is used to protect against excessive load current and short-circuits on the 3.3V auxiliary supply. The load current is monitored by placing a sense resistor R3 between AUXIN and AUXSENSE as shown in Figure 1. The circuit breaker trip threshold is 50mV and exhibits a response time of 8 $\mu$ s. Unlike the PCI supplies which use the current foldback limit with circuit breaker during short-circuits, here the circuit breaker will trip and immediately pull AUXGATE to ground if the voltage between AUXIN and AUXSENSE exceeds 50mV for more than 8 $\mu$ s. The external N-channel transistor is turned off and FAULT is pulled low. The circuit breaker is reset when AUXON is cycled low then high, or the AUXIN supply is cycled. If the circuit breaker feature is not required, the AUXSENSE pin can be shorted to AUXIN.

The trip current of the circuit breaker is set by:

$$I_{TRIP} = 50\text{mV}/R3$$

As a design aid, the trip current for commonly used values for R3 is given in Table 3.

**Table 3.  $I_{TRIP}$  vs R3**

R3 ( $\Omega$ )	$I_{TRIP}$
0.05	1A
0.06	833mA
0.07	714mA
0.08	625mA
0.09	556mA
0.1	500mA

If more than 8 $\mu$ s of response time is needed to reject supply current ripple noise, an external resistor, R<sub>F</sub>, of 20 $\Omega$  and capacitor, C<sub>F</sub>, of 1 $\mu$ F (Figure 6) can be added to the AUXSENSE circuit. This will give a delay of 15 $\mu$ s.

**Table 4. N-Channel Power MOSFET Selection Guide**

CURRENT RATING	PART NUMBER	PACKAGE	V <sub>DS</sub> MAX	V <sub>GS</sub> MAX	R <sub>DS(on)</sub>	MANUFACTURER
8.0A	Si4412ADY	SO-8	30V	$\pm$ 20V	0.024 $\Omega$	Vishay-Siliconix
3.5A	Si2306DS	SOT-23	30V	$\pm$ 20V	0.057 $\Omega$	Vishay-Siliconix
10A	Si4410DY	SO-8	30V	$\pm$ 20V	0.013 $\Omega$	Vishay-Siliconix
13A	IRF7413	SO-8	30V	$\pm$ 20V	0.011 $\Omega$	International Rectifier
2.7A	FDN 359AN	SOT-23	30V	$\pm$ 20V	0.046 $\Omega$	Fairchild Semiconductor

### Supply Bypass Capacitors

In motherboard applications, large bypass capacitors are recommended at each of the system power supplies to minimize supply glitches as a result of board insertion. A supply bypass capacitor of  $\geq 100\mu\text{F}$  at 12V<sub>IN</sub> connection is recommended.

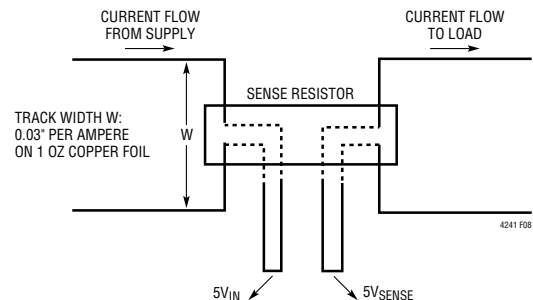

**Figure 8. Making PCB Connections to the Sense Resistor for the 5V Rail**

### PCB Layout Considerations for the Sense Resistor

For proper circuit breaker operation, 4-wire Kelvin-sense connections between the sense resistor and the LTC4241's 5V<sub>IN</sub> and 5V<sub>SENSE</sub> pins, 3V<sub>IN</sub> and 3V<sub>SENSE</sub> pins and AUXIN and AUXSENSE pins are strongly recommended. The drawing in Figure 8 illustrates the correct way of making connections between the LTC4241 and the sense resistor. PCB layout should be balanced and symmetrical to minimize wiring errors. In addition, the PCB layout for the sense resistors and the power MOSFETs should include good thermal management techniques for optimal sense resistor power dissipation.

### Power MOSFET and Sense Resistor Selection

Table 4 lists some available N-channel power MOSFETs. Table 5 lists some current sense resistors that can be used with the LTC4241's circuit breakers. Table 6 lists the supplier web site addresses for discrete components mentioned throughout this datasheet.



## APPLICATIONS INFORMATION

**Table 5. Sense Resistor Selection Guide**

CURRENT LIMIT VALUE	PART NUMBER	DESCRIPTION	MANUFACTURER
0.7A	WSL2010R07	0.07Ω, 0.5W, 1% Resistor	Vishay-Dale
1A	LR120601R055F WSL2010R055	0.055Ω, 0.5W, 1% Resistor	IRC-TT Vishay-Dale
2A	LR120601R028F WSL2010R028	0.028Ω, 0.5W, 1% Resistor	IRC-TT Vishay-Dale
5A	LR120601R011F WSL2010R011	0.011Ω, 0.5W, 1% Resistor	IRC-TT Vishay-Dale
7.9A	WSL2512R007	0.007Ω, 1W, 1% Resistor	Vishay-Dale
11A	WSL2512R005	0.005Ω, 1W, 1% Resistor	Vishay-Dale

**Table 6. Manufacturers' Web Site**

MANUFACTURER	WEB SITE
International Rectifier	www.irf.com
Fairchild Semiconductor	www.fairchildsemi.com
IRC-TT	www.irctt.com
Vishay-Dale	www.vishay.com
Vishay-Siliconix	www.vishay.com
Diodes, Inc.	www.diodes.com

## PACKAGE DESCRIPTION

**GN Package**  
**20-Lead Plastic SSOP (Narrow .150 Inch)**  
 (Reference LTC DWG # 05-08-1641)

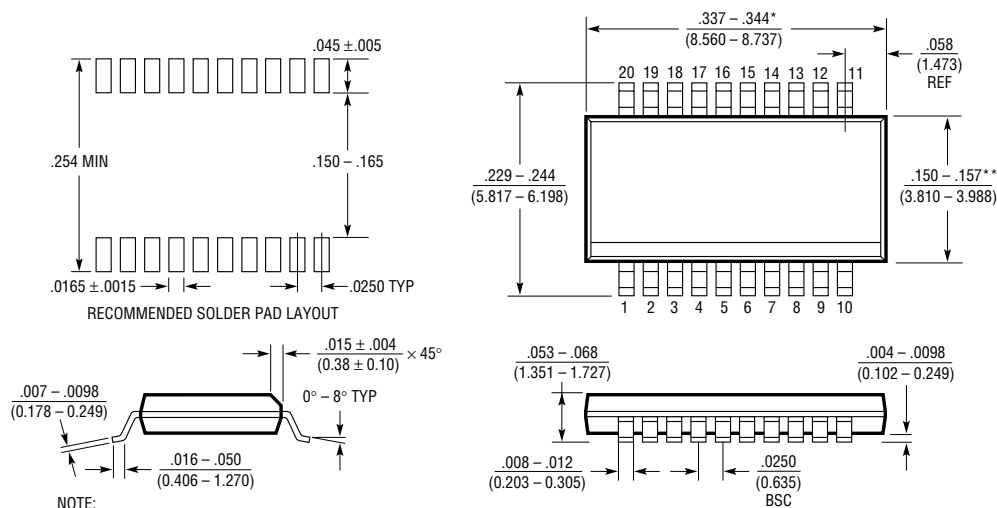

GN20 (SSOP) 0502

sn4241 4241f