

# 30MHz to 1.4GHz IQ Demodulator with IIP2 and DC Offset Control

## FEATURES

- I/Q Bandwidth of 530MHz or Higher
- High IIP3: 31dBm at 450MHz, 28dBm at 900MHz
- High IIP2: 70dBm at 450MHz, 65dBm at 900MHz
- User Adjustable IIP2 to >80dBm
- User Adjustable DC Offset Null
- High Input P1dB: 13.1dBm at 900MHz
- Image Rejection: 45dB at 900MHz
- Noise Figure: 9.9dB at 450MHz  
10dB at 900MHz
- Conversion Gain: 5.4dB at 450MHz  
5.7dB at 900MHz
- Shutdown Mode
- Operating Temperature Range ( $T_C$ ):  $-40^{\circ}\text{C}$  to  $105^{\circ}\text{C}$
- 24-Lead 4mm  $\times$  4mm QFN Package

## APPLICATIONS

- LTE/W-CDMA/TD-SCDMA Base Station Receivers
- Wideband DPD Receivers
- Point-To-Point Broadband Radios
- High Linearity Direct Conversion I/Q Receivers
- Image Rejection Receivers

## DESCRIPTION

The LTC<sup>®</sup>5584 is a direct conversion quadrature demodulator optimized for high linearity receiver applications in the 30MHz to 1.4GHz frequency range. It is also usable in the 10MHz to 30MHz and 1.4GHz to 2GHz ranges with reduced performance. It is suitable for communications receivers where an RF signal is directly converted into I and Q baseband signals with bandwidth of 530MHz or higher. The LTC5584 incorporates balanced I and Q mixers, LO buffer amplifiers and a precision, high frequency quadrature phase shifter. In addition, the LTC5584 provides four analog control voltage interface pins for IIP2 and DC offset correction, greatly simplifying system calibration.

The high linearity of the LTC5584 provides excellent spur-free dynamic range for the receiver. This direct conversion demodulator can eliminate the need for intermediate frequency (IF) signal processing, as well as the corresponding requirements for image filtering and IF filtering. These I/Q outputs can interface directly to channel-select filters (LPFs) or to baseband amplifiers.

LT, LTC, LTM, Linear Technology and the Linear logo are registered trademarks of Linear Technology Corporation. All other trademarks are the property of their respective owners.

## TYPICAL APPLICATION

Direct Conversion Receiver with IIP2 and DC Offset Calibration

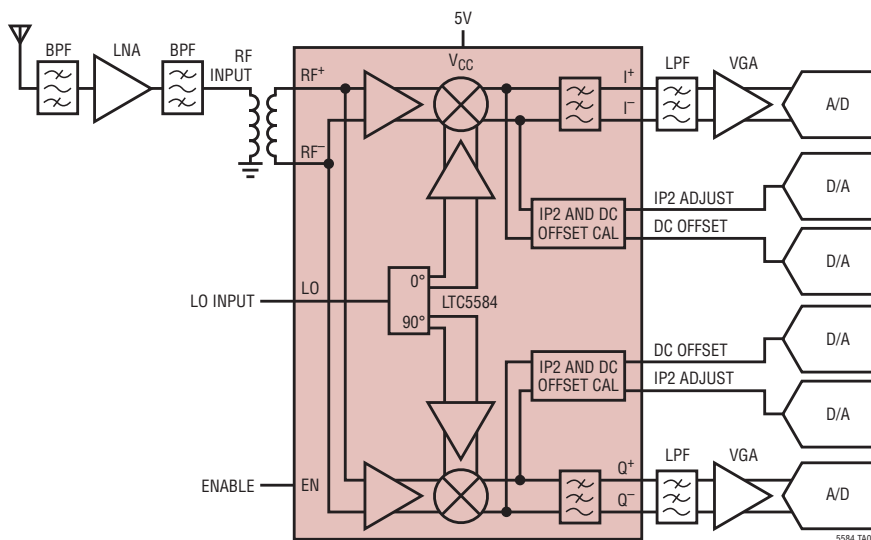

IIP2 vs IP2I, IP2Q Trim Voltage

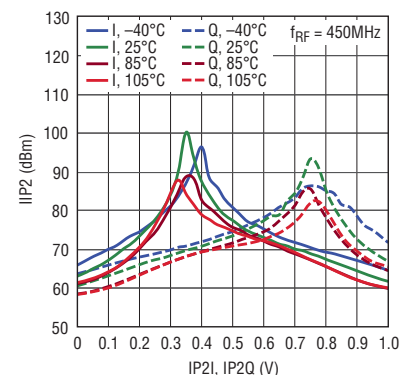

## ABSOLUTE MAXIMUM RATINGS

(Note 1)

$V_{CC}$ Supply Voltage .....	-0.3V to 5.5V
$V_{CAP}$ Voltage .....	$V_{CC} \pm 0.05V$
$I^-$ , $I^+$ , $Q^+$ , $Q^-$ , CMI, CMQ Voltage .....	2.5V to $V_{CC} + 0.3V$
Voltage on Any Other Pin .....	-0.3V to $V_{CC} + 0.3V$
$LO^+$ , $LO^-$ , $RF^+$ , $RF^-$ Input Power .....	20dBm
$RF^+$ , $RF^-$ Input DC Voltage .....	-0.3V to 2.7V
Maximum Junction Temperature ( $T_{JMAX}$ ) .....	150°C
Operating Temperature Range ( $T_C$ ) .....	-40°C to 105°C
(Note 3) .....	-40°C to 105°C
Storage Temperature Range .....	-65°C to 150°C

## PIN CONFIGURATION

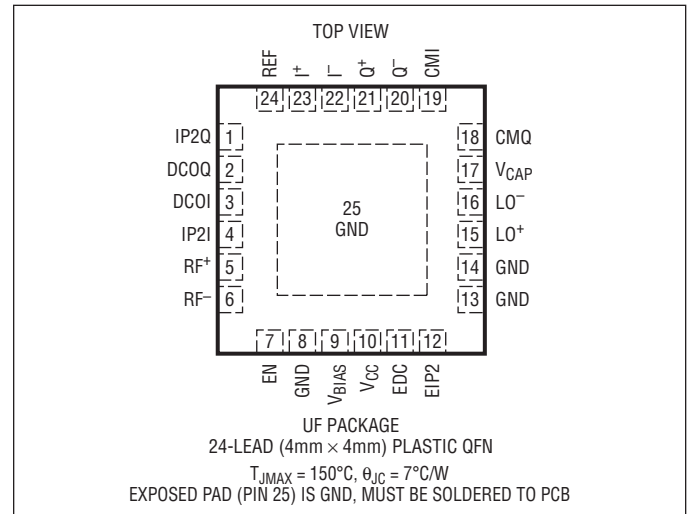

## ORDER INFORMATION

LEAD FREE FINISH	TAPE AND REEL	PART MARKING	PACKAGE DESCRIPTION	TEMPERATURE RANGE
LTC5584IUF#PBF	LTC5584IUF#TRPBF	5584	24-Lead (4mm x 4mm) Plastic QFN	-40°C to 105°C

Consult LTC Marketing for parts specified with wider operating temperature ranges.

Consult LTC Marketing for information on non-standard lead based finish parts.

For more information on lead free part marking, go to: <http://www.linear.com/leadfree/>

For more information on tape and reel specifications, go to: <http://www.linear.com/tapeandreel/>

## ELECTRICAL CHARACTERISTICS $T_C = 25^\circ\text{C}$ , $V_{CC} = 5V$ , $EN = 5V$ , $EDC = EIP2 = 0V$ , $REF = IP2I = IP2Q = DCOI = DCOQ = 0.5V$ , $P_{RF} = -5\text{dBm}$ (-5dBm/tone for 2-tone IIP2 and IIP3 tests), $P_{LO} = 6\text{dBm}$ , unless otherwise noted. (Notes 2, 3, 5, 6, 9)

SYMBOL	PARAMETER	CONDITIONS	MIN	TYP	MAX	UNITS
$f_{RF(RANGE)}$	RF Input Frequency Range	(Note 12)		30 to 1400		MHz
$f_{LO(RANGE)}$	LO Input Frequency Range	(Note 12)		30 to 1400		MHz
$P_{LO(RANGE)}$	LO Input Power Range	(Note 12)		0 to 10		dBm
<b><math>f_{RF1} = 140\text{MHz}</math>, <math>f_{RF2} = 141\text{MHz}</math>, <math>f_{LO} = 130\text{MHz}</math>, <math>L6 = 68\text{nH}</math>, <math>C19 = 8.0\text{pF}</math>, <math>L5 = 82\text{nH}</math></b>						
$f_{RF(MATCH)}$	RF Input Frequency Range	Return Loss > 10dB		95 to 190		MHz
$f_{LO(MATCH)}$	LO Input Frequency Range	Return Loss > 10dB		105 to 180		MHz
$G_V$	Voltage Conversion Gain	Loaded with 100 $\Omega$ Pull-Up (Note 8)		5.7		dB
NF	Noise Figure	Double-Side Band (Note 4)		9.9		dB
NFBLOCKING	Noise Figure Under Blocking Conditions	Double-Side Band, $P_{RF} = 0\text{dBm}$ (Note 7)		15.5		dB
IIP3	Input 3rd Order Intercept			33		dBm
IIP2	Input 2nd Order Intercept	Unadjusted, $EIP2 = 0V$		70		dBm
IIP2 <sub>OPT</sub>	Optimized Input 2nd Order Intercept	$EIP2 = 5V$ , $IP2I$ , $IP2Q$ Adjusted for Minimum IM2		80		dBm
P1dB	Input 1dB Compression			12		dBm
DC <sub>OFFSET</sub>	DC Offset at I/Q Outputs	Unadjusted, $EDC = 0V$ (Note 13)		1.5		mV
$\Delta G$	I/Q Gain Mismatch			0.02		dB
$\Delta\phi$	I/Q Phase Mismatch			0.2		Deg

## ELECTRICAL CHARACTERISTICS

$T_C = 25^\circ\text{C}$ ,  $V_{CC} = 5\text{V}$ ,  $EN = 5\text{V}$ ,  $EDC = EIP2 = 0\text{V}$ ,  $REF = IP2I = IP2Q = DC0I = DC0Q = 0.5\text{V}$ ,  $P_{RF} = -5\text{dBm}$  ( $-5\text{dBm}/\text{tone}$  for 2-tone IIP2 and IIP3 tests),  $P_{LO} = 6\text{dBm}$ , unless otherwise noted. (Notes 2, 3, 5, 6, 9)

SYMBOL	PARAMETER	CONDITIONS	MIN	TYP	MAX	UNITS
IRR	Image Rejection Ratio	(Note 10)		53		dB
LO-RF	LO to RF Leakage			-85		dBm
RF-LO	RF to LO Isolation			74		dB

$f_{RF1} = 450\text{MHz}$ ,  $f_{RF2} = 451\text{MHz}$ ,  $f_{LO} = 440\text{MHz}$ ,  $L6 = 15\text{nH}$ ,  $C19 = 1.0\text{pF}$ ,  $L5 = 12\text{nH}$ ,  $C14 = 4.0\text{pF}$

$f_{RF}(\text{MATCH})$	RF Input Frequency Range	Return Loss > 10dB		300 to 600		MHz
$f_{LO}(\text{MATCH})$	LO Input Frequency Range	Return Loss > 10dB		310 to 590		MHz
$G_V$	Voltage Conversion Gain	Loaded with 100 $\Omega$ Pull-Up (Note 8)		5.4		dB
NF	Noise Figure	Double-Side Band (Note 4)		9.9		dB
NF <sub>BLOCKING</sub>	Noise Figure Under Blocking Conditions	Double-Side Band, $P_{RF} = 0\text{dBm}$ (Note 7)		13.6		dB
IIP3	Input 3rd Order Intercept			31		dBm
IIP2	Input 2nd Order Intercept	Unadjusted, $EIP2 = 0\text{V}$		70		dBm
IIP2 <sub>OPT</sub>	Optimized Input 2nd Order Intercept	$EIP2 = 5\text{V}$ , IP2I, IP2Q Adjusted for Minimum IM2		80		dBm
P1dB	Input 1dB Compression			12.6		dBm
DC <sub>OFFSET</sub>	DC Offset at I/Q Outputs	Unadjusted, $EDC = 0\text{V}$ (Note 13)		2		mV
$\Delta G$	I/Q Gain Mismatch			0.02		dB
$\Delta\phi$	I/Q Phase Mismatch			0.25		Deg
IRR	Image Rejection Ratio	(Note 10)		52		dB
LO-RF	LO to RF Leakage			-80		dBm
RF-LO	RF to LO Isolation			70		dB

$f_{RF1} = 900\text{MHz}$ ,  $f_{RF2} = 901\text{MHz}$ ,  $f_{LO} = 940\text{MHz}$ ,  $C17 = 1.5\text{pF}$ ,  $L6 = 5.6\text{nH}$ ,  $C13 = 2.2\text{pF}$ ,  $L5 = 3.9\text{nH}$

$f_{RF}(\text{MATCH})$	RF Input Frequency Range	Return Loss > 10dB		630 to 1200		MHz
$f_{LO}(\text{MATCH})$	LO Input Frequency Range	Return Loss > 10dB		470 to 1100		MHz
$G_V$	Voltage Conversion Gain	Loaded with 100 $\Omega$ Pull-Up (Note 8)		5.7		dB
NF	Noise Figure	Double-Side Band (Note 4)		10		dB
NF <sub>BLOCKING</sub>	Noise Figure Under Blocking Conditions	Double-Side Band, $P_{RF} = 0\text{dBm}$ (Note 7)		14.7		dB
IIP3	Input 3rd Order Intercept			28		dBm
IIP2	Input 2nd Order Intercept	Unadjusted, $EIP2 = 0\text{V}$		65		dBm
IIP2 <sub>OPT</sub>	Optimized Input 2nd Order Intercept	$EIP2 = 5\text{V}$ , IP2I, IP2Q Adjusted for Minimum IM2		80		dBm
P1dB	Input 1dB Compression			13.1		dBm
DC <sub>OFFSET</sub>	DC Offset at I/Q Outputs	Unadjusted, $EDC = 0\text{V}$ (Note 13)		2.5		mV
$\Delta G$	I/Q Gain Mismatch			0.01		dB
$\Delta\phi$	I/Q Phase Mismatch			0.7		Deg
IRR	Image Rejection Ratio	(Note 10)		45		dB
LO-RF	LO to RF Leakage			-75		dBm
RF-LO	RF to LO Isolation			65		dB

### Power Supply and Other Parameters

$V_{CC}$	Supply Voltage		4.75	5.0	5.25	V
$I_{CC}$	Supply Current	$EDC = EIP2 = V_{CC}$	180	200	220	mA
$I_{CC}(\text{LOW})$	Supply Current	$EDC = EIP2 = 0\text{V}$	174	194	214	mA
$I_{CC}(\text{OFF})$	Shutdown Current	$EN < 0.3\text{V}$		11	900	$\mu\text{A}$
$t_{ON}$	Turn-On Time	EN Transition from Logic Low to High (Note 14)		0.2		$\mu\text{s}$
$t_{OFF}$	Turn-Off Time	EN Transition from Logic High to Low (Note 15)		0.8		$\mu\text{s}$
$V_{EH}$	EN, EDC, EIP2 Input High Voltage (On)		2.0			V
$V_{EL}$	EN, EDC, EIP2 Input Low Voltage (Off)				0.3	V

## ELECTRICAL CHARACTERISTICS

$T_C = 25^\circ\text{C}$ ,  $V_{CC} = 5\text{V}$ ,  $EN = 5\text{V}$ ,  $EDC = EIP2 = 0\text{V}$ ,  $REF = IP2I = IP2Q = DCOI = DCOQ = 0.5\text{V}$ ,  $P_{RF} = -5\text{dBm}$  ( $-5\text{dBm}/\text{tone}$  for 2-tone IIP2 and IIP3 tests),  $P_{LO} = 6\text{dBm}$ , unless otherwise noted. (Notes 2, 3, 5, 6, 9)

SYMBOL	PARAMETER	CONDITIONS	MIN	TYP	MAX	UNITS
$I_{ENH}$	EN Pin Input Current	$EN = 5.0\text{V}$		52		$\mu\text{A}$
$I_{EDCH}$	EDC Pin Input Current	$EDC = 5.0\text{V}$		33		$\mu\text{A}$
$I_{EIP2H}$	EIP2 Pin Input Current	$EIP2 = 5.0\text{V}$		50		$\mu\text{A}$
$V_{REF}$	REF Pin Voltage	With REF Pin Unloaded		0.5		V
$V_{REF(RANGE)}$	REF Pin Voltage Range	When Driven with External Source		0.4 to 0.7		V
$Z_{REF}$	REF Input Impedance	(Note 11)		2  1		$\text{k}\Omega  \text{pF}$
	DCOI, DCOQ, IP2I, IP2Q Pin Voltage	Unloaded		0.5		V
	DCOI, DCOQ, IP2I, IP2Q Voltage Range	When Driven with External Source		0 to $2V_{REF}$		V
	DCOI, DCOQ, IP2I, IP2Q Impedance	(Note 11)		8  1		$\text{k}\Omega  \text{pF}$
	DCOI, DCOQ, IP2I, IP2Q Settling Time	For Step Input, Output with 90% of Final Value		20		ns
	DC Offset Adjustment Range	DCOI, DCOQ Swept from 0V to 1V, $EDC = 5\text{V}$		$\pm 20$		mV
	DC Offset Drift Over Temperature	Unadjusted, $EDC = 0\text{V}$		20		$\mu\text{V}/^\circ\text{C}$
$V_{CM}$	$I^+$ , $I^-$ , $Q^+$ , $Q^-$ Common Mode Voltage			$V_{CC} - 1.5$		V
$Z_{OUT}$	$I^+$ , $I^-$ , $Q^+$ , $Q^-$ Output Impedance	Single Ended		100  6		$\Omega  \text{pF}$
$BW_{BB}$	$I^+$ , $I^-$ , $Q^+$ , $Q^-$ Output Bandwidth	100 $\Omega$ External Pull-Up, $-3\text{dB}$ Corner Frequency		530		MHz

**Note 1:** Stresses beyond those listed under Absolute Maximum Ratings may cause permanent damage to the device. Exposure to any Absolute Maximum Rating condition for extended periods may affect device reliability and lifetime.

**Note 2:** Tests are performed with the test circuit of Figure 1.

**Note 3:** The LTC5584 is guaranteed to be functional over the  $-40^\circ\text{C}$  to  $105^\circ\text{C}$  case temperature operating range.

**Note 4:** DSB noise figure is measured at the baseband frequency of 15MHz with a small-signal noise source without any filtering on the RF input and no other RF signal applied.

**Note 5:** Performance at the RF frequencies listed is measured with external RF and LO impedance matching, as shown in the table of Figure 1.

**Note 6:** The complementary outputs ( $I^+$ ,  $I^-$  and  $Q^+$ ,  $Q^-$ ) are combined using a  $180^\circ$  phase-shift combiner.

**Note 7:** Noise figure under blocking conditions ( $NF_{BLOCKING}$ ) is measured at an output noise frequency of 60MHz with an RF input blocking signal at  $f_{LO} + 1\text{MHz}$ . Both RF and LO input signals are appropriately filtered, as well as the baseband output.  $NF_{BLOCKING}$  measured at  $f_{LO}$  of 160MHz, 460MHz and 885MHz.

**Note 8:** Voltage conversion gain is calculated from the average measured power conversion gain of the I and Q outputs using the test circuit shown in Figure 1. Power conversion gain is measured with a 100 $\Omega$  differential load impedance on the I and Q outputs.

**Note 9:** Baseband outputs have a 100 $\Omega$  external pull-up resistor to  $V_{CC}$  as shown in the test circuit shown in Figure 1.

**Note 10:** Image rejection is calculated from the measured gain error and phase error using the method listed in the appendix.

**Note 11:** The DCOI, DCOQ, IP2I, IP2Q pins have an 8k internal resistor to ground. The REF pin has a 2k internal resistor to ground. If unconnected, these pins will float up to 500mV through internal current sources. A low output resistance voltage source is recommended for driving these pins.

**Note 12:** This is the recommended operating range, operation outside the listed range is possible with degraded performance to some parameters.

**Note 13:** DC offset measured differentially between  $I^+$  and  $I^-$  and between  $Q^+$  and  $Q^-$ . The reported value is the mean of the absolute values of the characterization data distribution.

**Note 14:** Baseband amplitude is within 10% of final value.

**Note 15:** Baseband amplitude is at least 30dB down from its on state.

**DC PERFORMANCE CHARACTERISTICS** EN = 5V, EDC = 0V and EIP2 = 0V. Test circuit shown in Figure 1

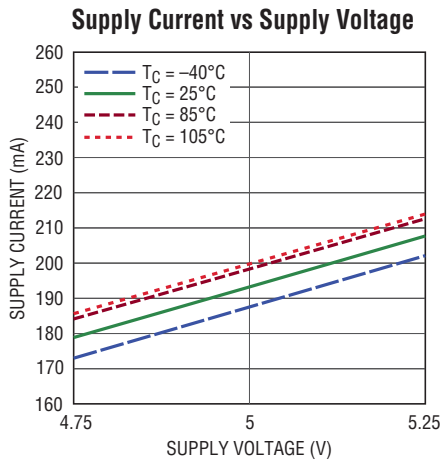

5585 G01

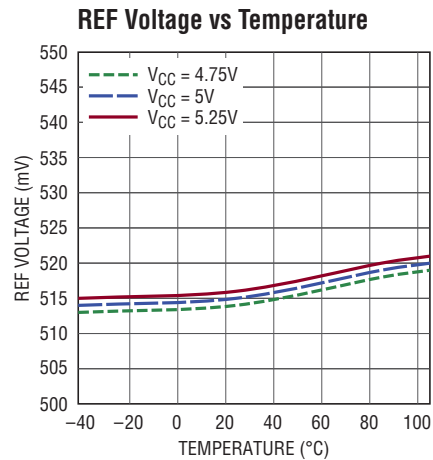

5584 G02

**TYPICAL PERFORMANCE CHARACTERISTICS** 140MHz application.  $V_{CC} = 5\text{V}$ , EN = 5V, EDC = 0V, EIP2 = 0V, REF = 0.5V,  $T_C = 25^\circ\text{C}$ ,  $P_{LO} = 6\text{dBm}$ ,  $f_{LO} = 130\text{MHz}$ ,  $f_{RF1} = 140\text{MHz}$ ,  $f_{RF2} = 141\text{MHz}$ ,  $f_{BB} = 10\text{MHz}$ ,  $P_{RF1} = P_{RF2} = -5\text{dBm}$ , DC Blocks and Mini-Circuits PSCJ-2-1 180° combiner at baseband outputs de-embedded from measurement unless otherwise noted. Test circuit with RF and LO ports impedance matched as in Figure 1.

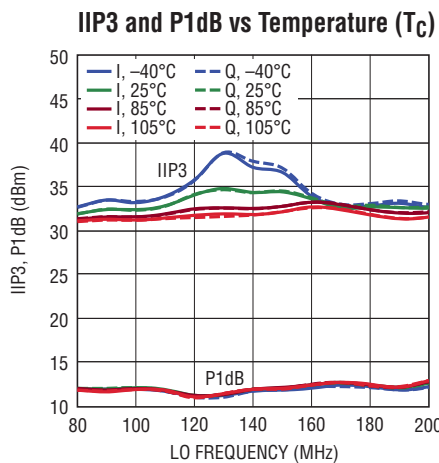

5584 G03

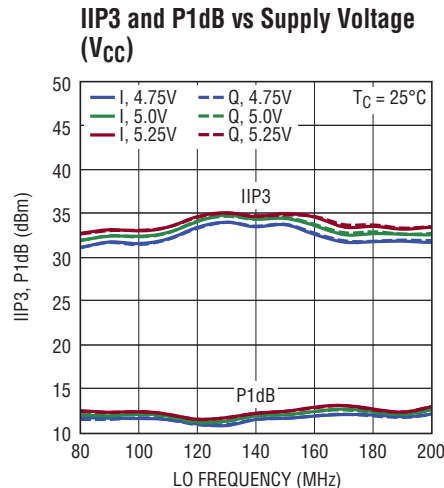

5584 G04

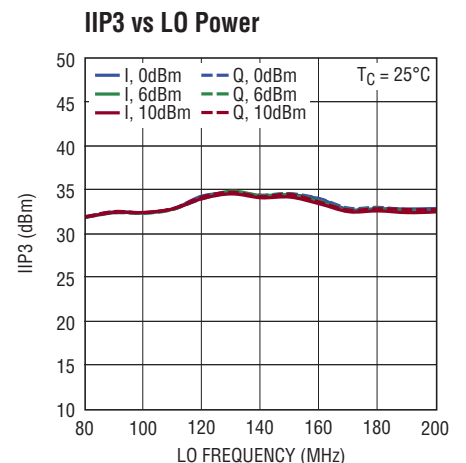

5584 G05

**TYPICAL PERFORMANCE CHARACTERISTICS** 140MHz application.  $V_{CC} = 5V$ ,  $EN = 5V$ ,  $EDC = 0V$ ,  $EIP2 = 0V$ ,  $REF = 0.5V$ ,  $T_C = 25^\circ C$ ,  $P_{LO} = 6dBm$ ,  $f_{LO} = 130MHz$ ,  $f_{RF1} = 140MHz$ ,  $f_{RF2} = 141MHz$ ,  $f_{BB} = 10MHz$ ,  $P_{RF1} = P_{RF2} = -5dBm$ , DC Blocks and Mini-Circuits PSCJ-2-1 180° combiner at baseband outputs de-embedded from measurement unless otherwise noted. Test circuit with RF and LO ports impedance matched as in Figure 1.

**2-Tone IIP3 vs RF Power**

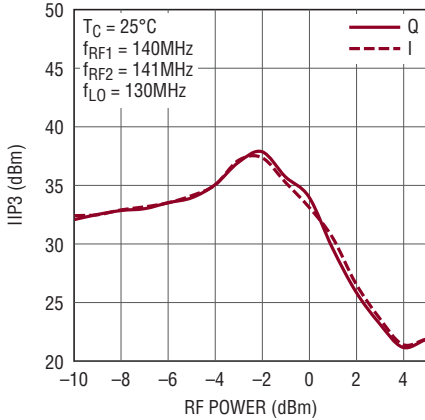

5584 G06

**Uncalibrated IIP2 vs Temperature ( $T_C$ )**

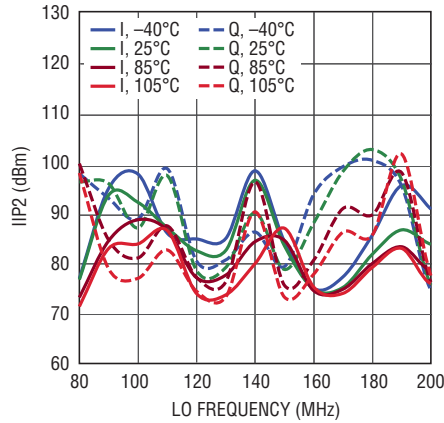

5584 G07

**Uncalibrated IIP2 vs LO Power**

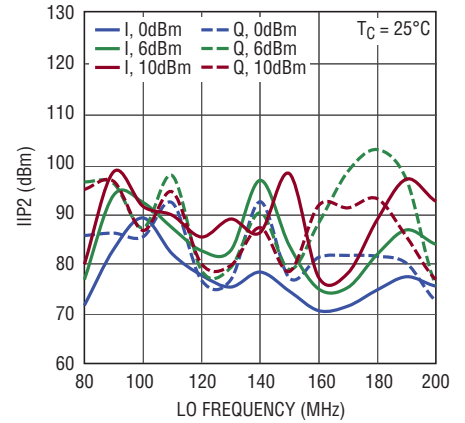

5584 G08

**IIP2 vs IP2I, IP2Q Trim Voltage**

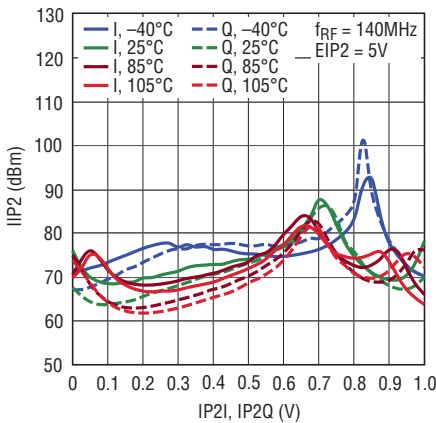

5584 G09

**IIP2 vs RF Tone Spacing**

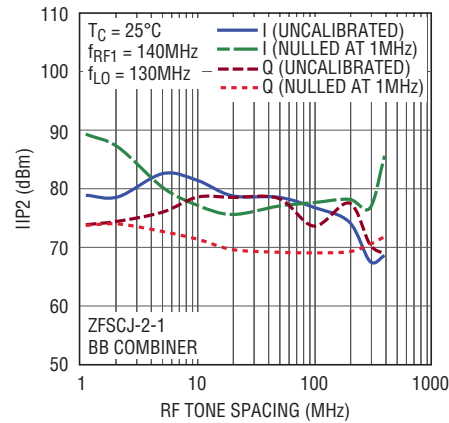

5584 G10

**2x2 Half-IF IIP2 vs RF to LO Tone Spacing**

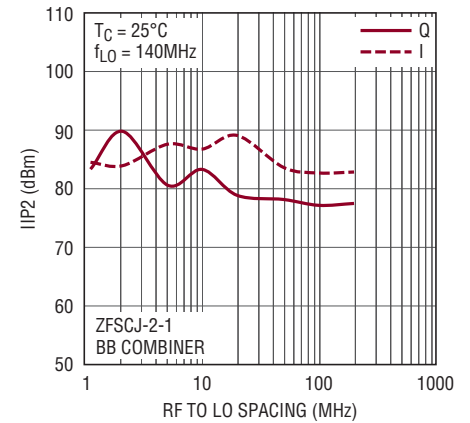

5584 G11

**Noise Figure and Conversion Gain vs Temperature ( $T_C$ )**

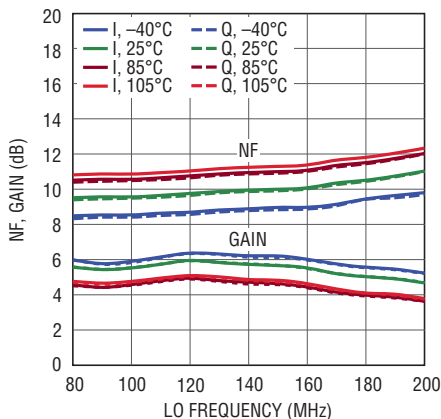

5584 G12

**Noise Figure and Conversion Gain vs LO Power**

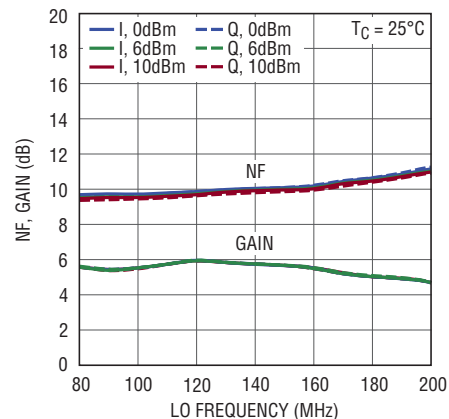

5584 G13

**Noise Figure vs RF Power and IP2I, IP2Q Trim Voltage**

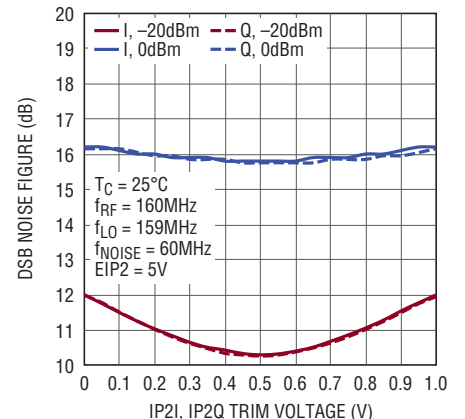

5584 G14

**TYPICAL PERFORMANCE CHARACTERISTICS** 140MHz application.  $V_{CC} = 5V$ ,  $EN = 5V$ ,  $EDC = 0V$ ,  $EIP2 = 0V$ ,  $REF = 0.5V$ ,  $T_C = 25^\circ C$ ,  $P_{LO} = 6dBm$ ,  $f_{LO} = 130MHz$ ,  $f_{RF1} = 140MHz$ ,  $f_{RF2} = 141MHz$ ,  $f_{BB} = 10MHz$ ,  $P_{RF1} = P_{RF2} = -5dBm$ , DC Blocks and Mini-Circuits PSCJ-2-1 180° combiner at baseband outputs de-embedded from measurement unless otherwise noted. Test circuit with RF and LO ports impedance matched as in Figure 1.

**Noise Figure vs RF Input Power**

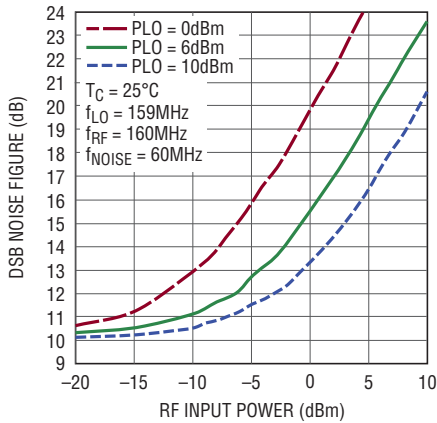

5584 G15

**DC Offset vs Temperature ( $T_C$ )**

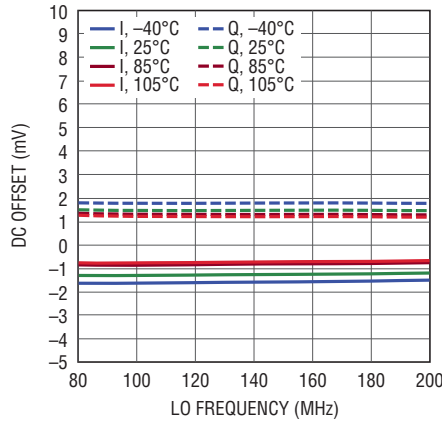

5584 G16

**DC Offset vs LO Power**

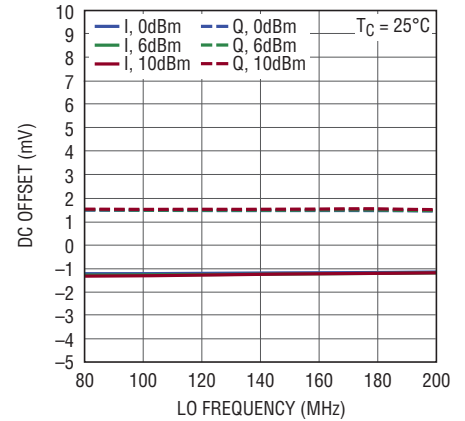

5584 G17

**DC Offset vs DCOI, DCOQ Control Voltage**

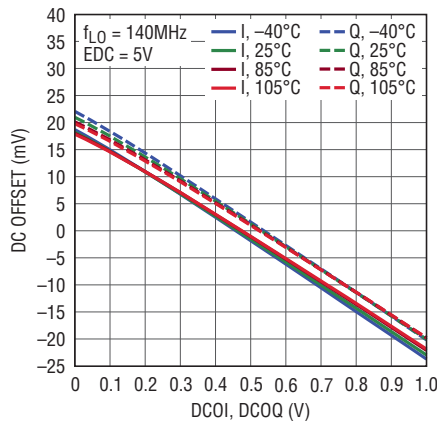

5584 G18

**DC Offset Distribution, I-Side**

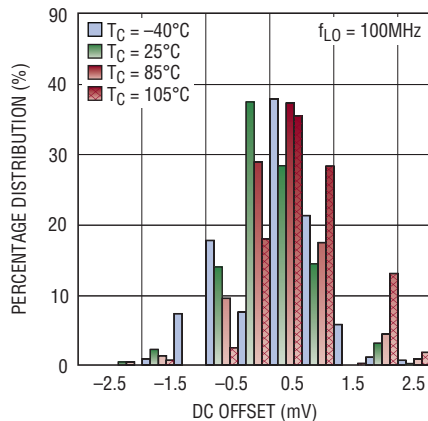

5584 G19

**DC Offset Distribution, Q-Side**

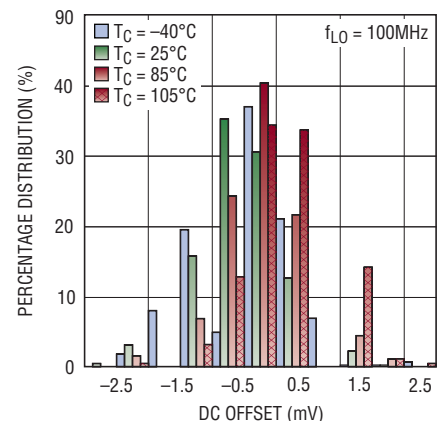

5584 G20

**LO to RF Leakage and RF to LO Isolation**

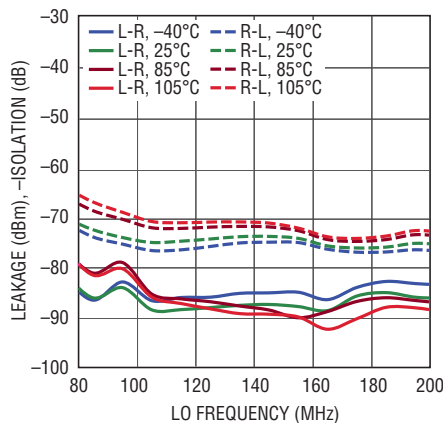

5584 G21

**Image Rejection vs Temperature**

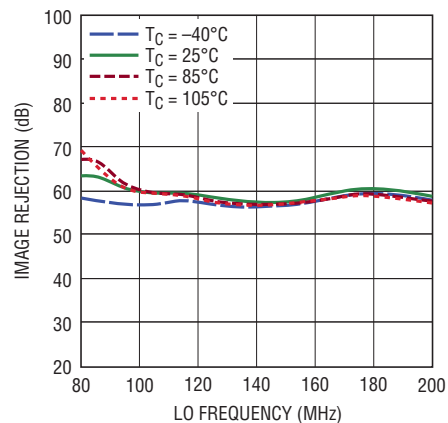

5584 G22



**TYPICAL PERFORMANCE CHARACTERISTICS** 450MHz application.  $V_{CC} = 5V$ ,  $EN = 5V$ ,  $EDC = 0V$ ,  $REF = 0.5V$ ,  $EIP2 = 0V$ ,  $T_C = 25^\circ C$ ,  $P_{LO} = 6dBm$ ,  $f_{LO} = 440MHz$ ,  $f_{RF1} = 450MHz$ ,  $f_{RF2} = 451MHz$ ,  $f_{BB} = 10MHz$ ,  $P_{RF1} = P_{RF2} = -5dBm$ , DC Blocks and Mini-Circuits PSCJ-2-1 180° combiner at baseband outputs de-embedded from measurement unless otherwise noted. Test circuit with RF and LO ports impedance matched as in Figure 1.

**IIP3 and P1dB vs Temperature ( $T_C$ )**

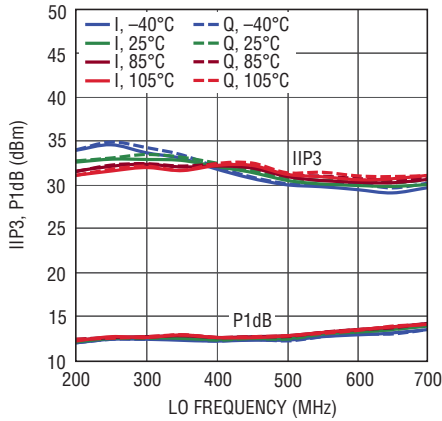

5584 G23

**IIP3 and P1dB vs Supply Voltage ( $V_{CC}$ )**

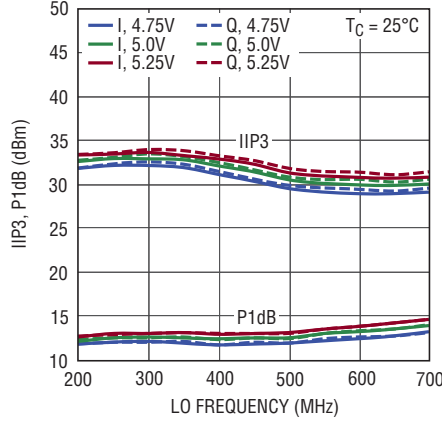

5584 G24

**IIP3 vs LO Power**

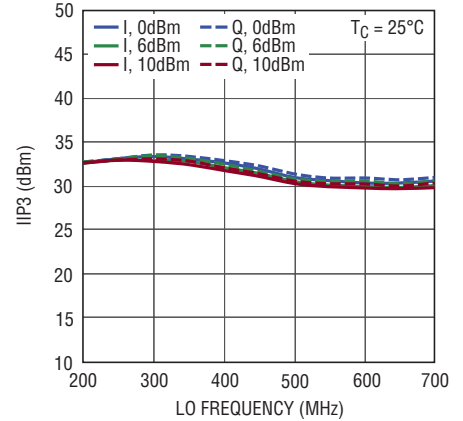

5584 G25

**2-Tone IIP3 vs RF Power**

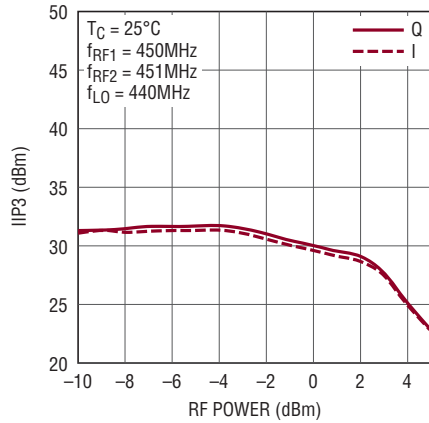

5584 G26

**Uncalibrated IIP2 vs Temperature ( $T_C$ )**

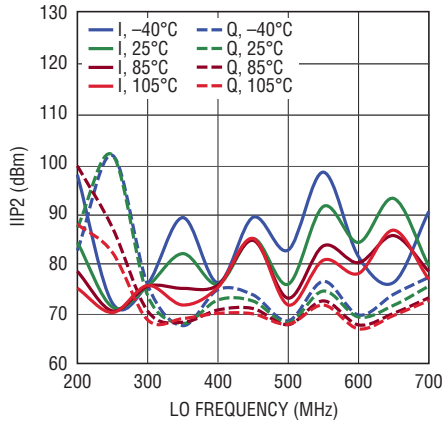

5584 G27

**Uncalibrated IIP2 vs LO Power**

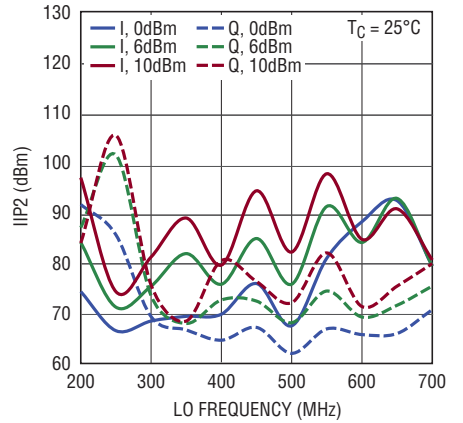

5584 G28

**IIP2 vs IP2I, IP2Q Trim Voltage**

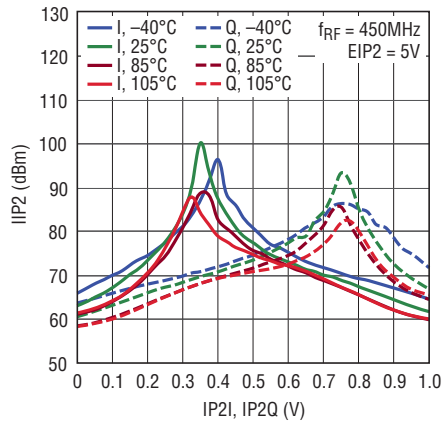

5584 G29

**IIP2 vs RF Tone Spacing**

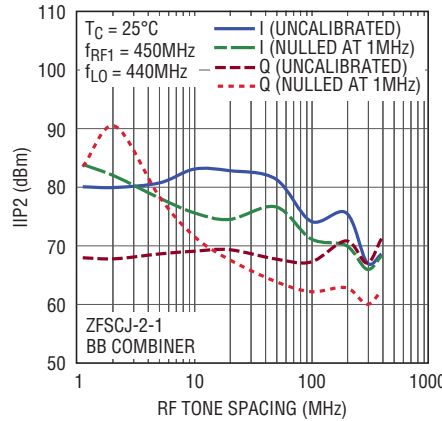

5584 G30

**2x2 Half-IF IIP2 vs RF to LO Tone Spacing**

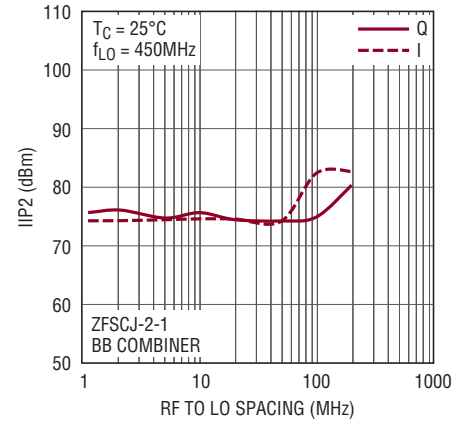

5584 G31



**TYPICAL PERFORMANCE CHARACTERISTICS** 450MHz application.  $V_{CC} = 5V$ ,  $EN = 5V$ ,  $EDC = 0V$ ,  $REF = 0.5V$ ,  $EIP2 = 0V$ ,  $T_C = 25^\circ C$ ,  $P_{LO} = 6dBm$ ,  $f_{LO} = 440MHz$ ,  $f_{RF1} = 450MHz$ ,  $f_{RF2} = 451MHz$ ,  $f_{BB} = 10MHz$ ,  $P_{RF1} = P_{RF2} = -5dBm$ , DC Blocks and Mini-Circuits PSCJ-2-1 180° combiner at baseband outputs de-embedded from measurement unless otherwise noted. Test circuit with RF and LO ports impedance matched as in Figure 1.

**Noise Figure vs RF Input Power**

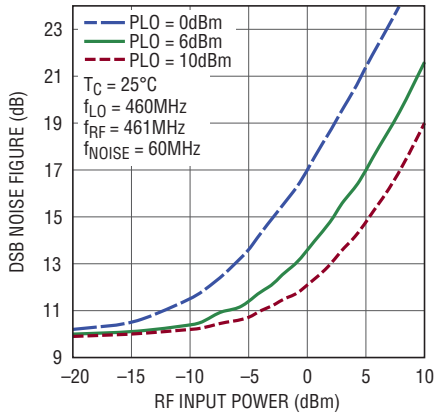

5584 G32

**Noise Figure and Conversion Gain vs Temperature ( $T_C$ )**

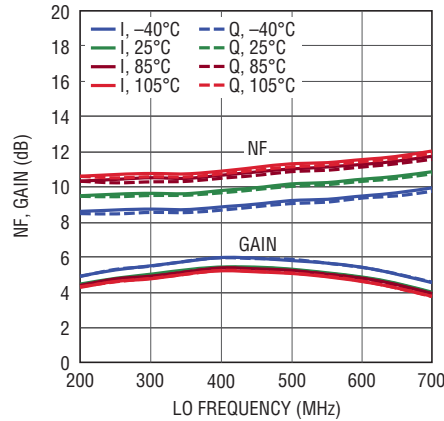

5584 G33

**Noise Figure and Conversion Gain vs LO Power**

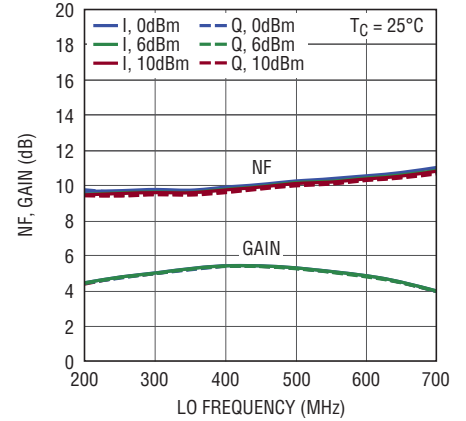

5584 G34

**DC Offset vs Temperature ( $T_C$ )**

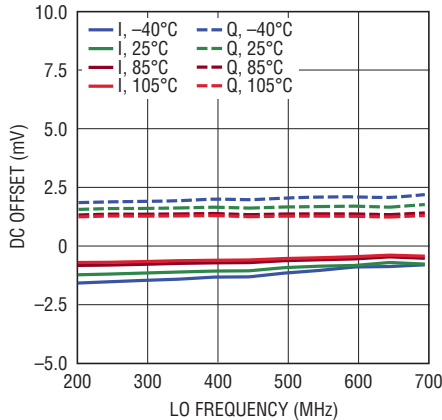

5584 G35

**DC Offset vs DCOI, DCOQ Control Voltage**

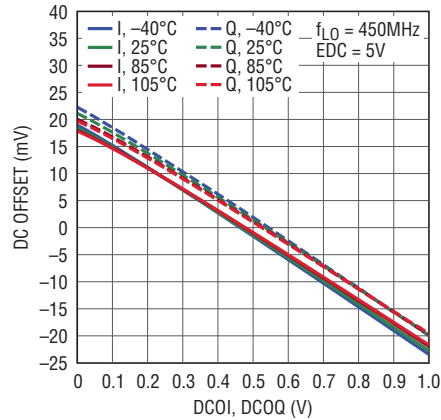

5584 G36

**DC Offset vs LO Power**

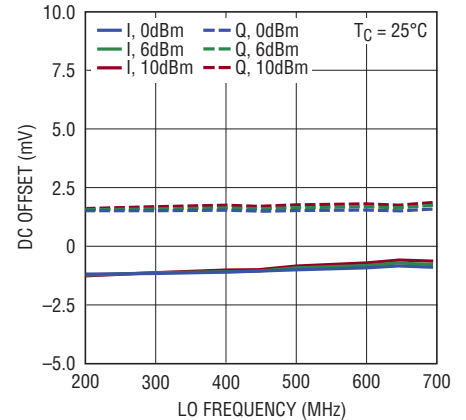

5584 G37

**LO to RF Leakage and RF to LO Isolation**

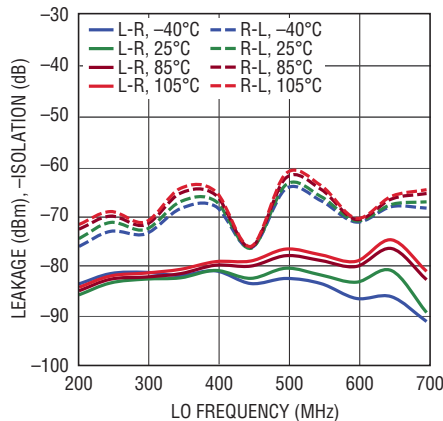

5584 G38

**Image Rejection vs Temperature**

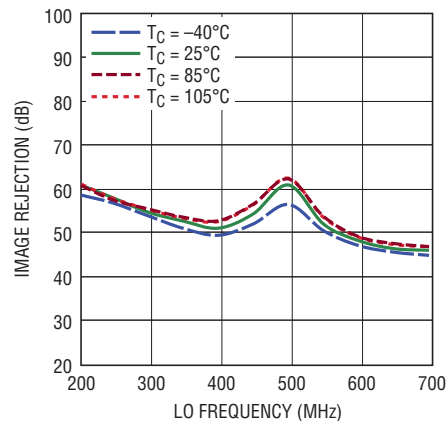

5584 G39

## TYPICAL PERFORMANCE CHARACTERISTICS

900MHz application.  $V_{CC} = 5V$ ,  $EN = 5V$ ,  $EDC = 0V$ ,  $EIP2 = 0V$ ,  $REF = 0.5V$ ,  $T_C = 25^\circ C$ ,  $P_{LO} = 6dBm$ ,  $f_{LO} = 890MHz$ ,  $f_{RF1} = 900MHz$ ,  $f_{RF2} = 901MHz$ ,  $f_{BB} = 10MHz$ ,  $P_{RF1} = P_{RF2} = -5dBm$ , DC Blocks and Mini-Circuits PSCJ-2-1 180° combiner at baseband outputs de-embedded from measurement unless otherwise noted. Test circuit with RF and LO ports impedance matched as in Figure 1.

**IIP3 and P1dB vs Temperature ( $T_C$ )**

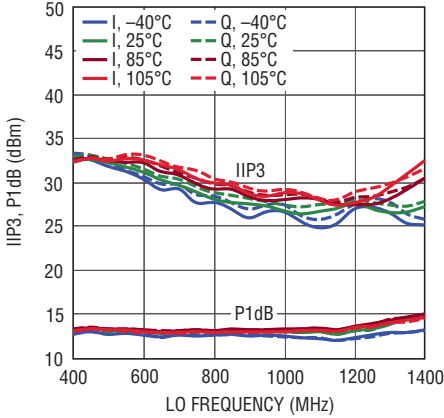

5584 G40

**IIP3 and P1dB vs Supply Voltage ( $V_{CC}$ )**

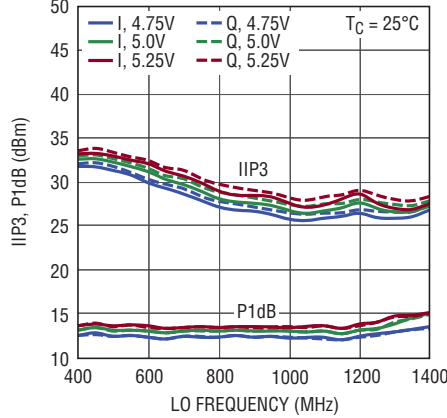

5584 G41

**IIP3 vs LO Power**

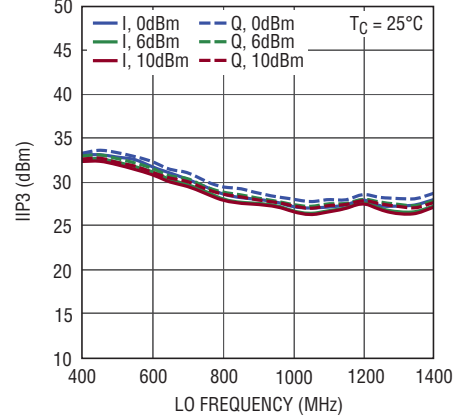

5584 G42

**2-Tone IIP3 vs RF Power**

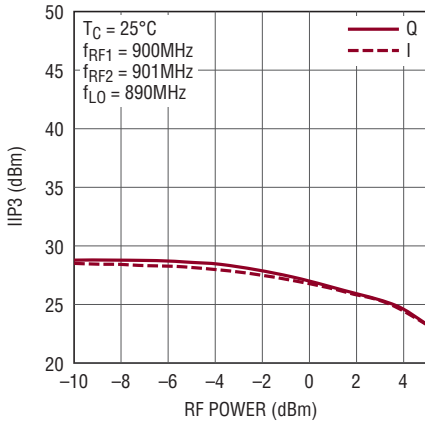

5584 G43

**Uncalibrated IIP2 vs Temperature ( $T_C$ )**

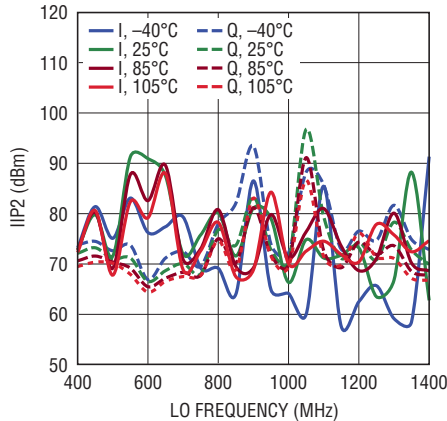

5584 G44

**Uncalibrated IIP2 vs LO Power**

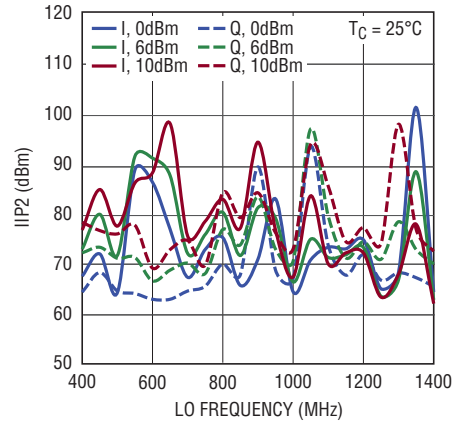

5584 G45

**IIP2 vs IP2I, IP2Q Trim Voltage**

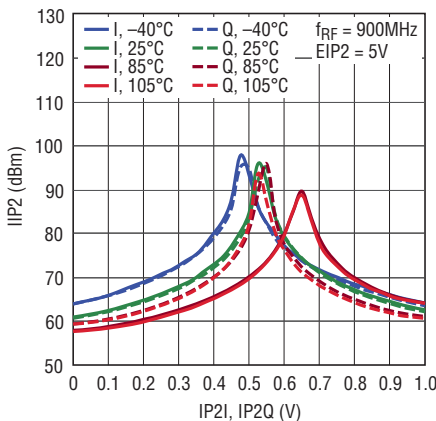

5585 G46

**IIP2 vs RF Tone Spacing**

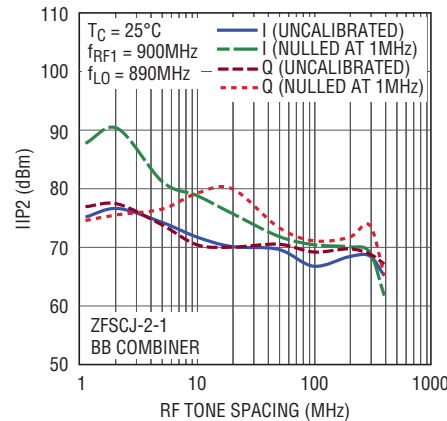

5584 G47

**2x2 Half-IF IIP2 vs RF to LO Tone Spacing**

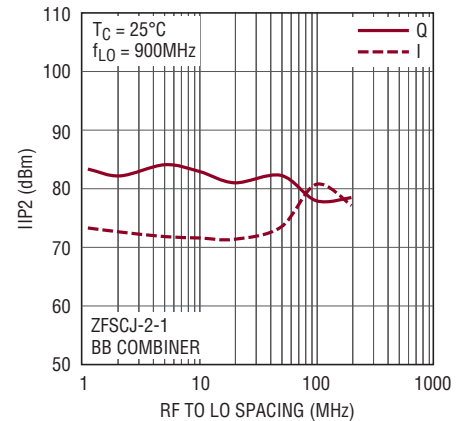

5584 G48

**TYPICAL PERFORMANCE CHARACTERISTICS** 900MHz application.  $V_{CC} = 5V$ ,  $EN = 5V$ ,  $EDC = 0V$ ,  $EIP2 = 0V$ ,  $REF = 0.5V$ ,  $T_C = 25^\circ C$ ,  $P_{LO} = 6dBm$ ,  $f_{LO} = 890MHz$ ,  $f_{RF1} = 900MHz$ ,  $f_{RF2} = 901MHz$ ,  $f_{BB} = 10MHz$ ,  $P_{RF1} = P_{RF2} = -5dBm$ , DC Blocks and Mini-Circuits PSCJ-2-1 180° combiner at baseband outputs de-embedded from measurement unless otherwise noted. Test circuit with RF and LO ports impedance matched as in Figure 1.

**Noise Figure vs RF Input Power**

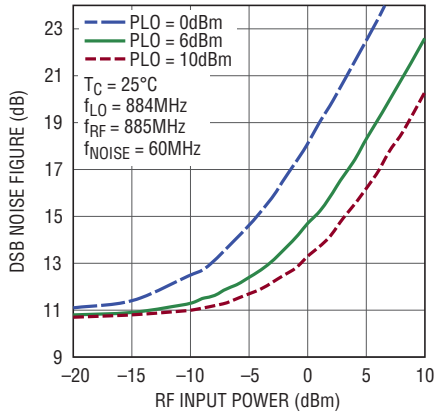

5584 G49

**Noise Figure and Conversion Gain vs Temperature ( $T_C$ )**

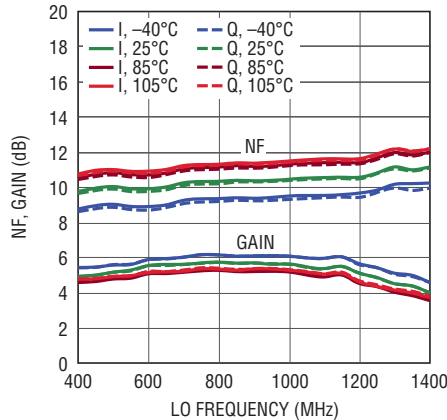

5584 G50

**Noise Figure and Conversion Gain vs LO Power**

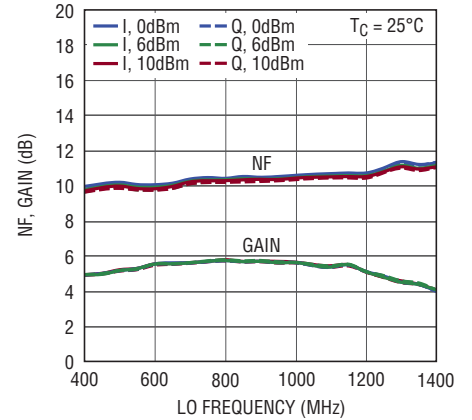

5584 G51

**DC Offset vs Temperature ( $T_C$ )**

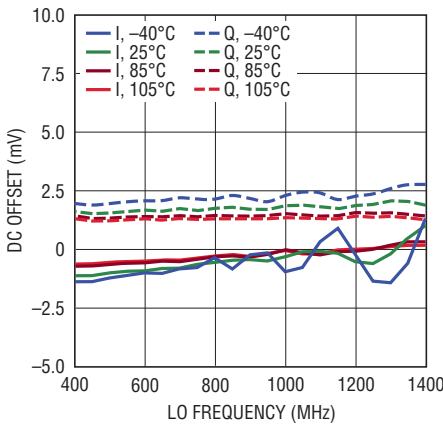

5584 G52

**DC Offset vs LO Power**

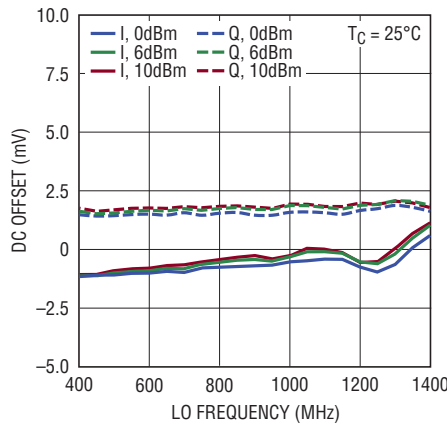

5584 G53

**DC Offset vs DCOI, DCOQ Control Voltage**

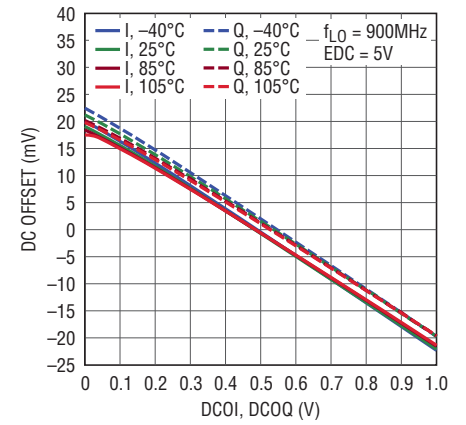

5584 G54

**LO to RF Leakage and RF to LO Isolation**

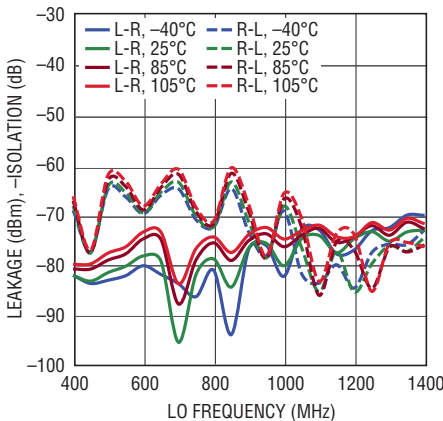

5584 G55

**Image Rejection vs Temperature**

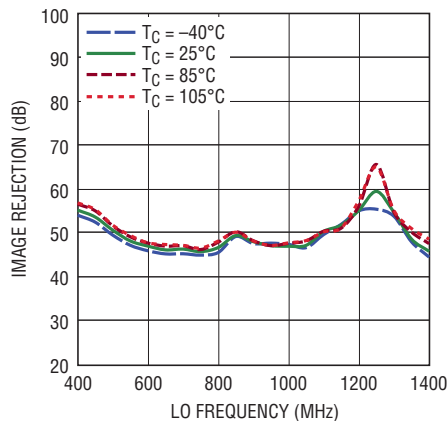

5584 G56

**Conversion Gain Distribution**

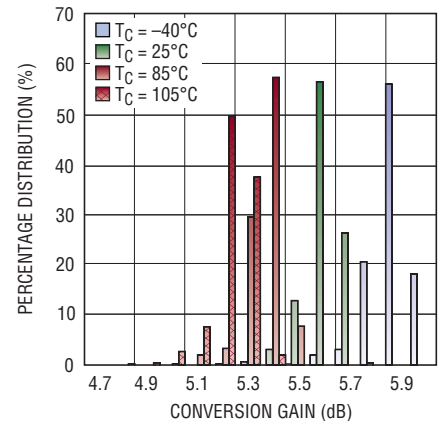

5584 G57

**TYPICAL PERFORMANCE CHARACTERISTICS**

900MHz application.  $V_{CC} = 5V$ ,  $EN = 5V$ ,  $EDC = 0V$ ,  $EIP2 = 0V$ ,  $REF = 0.5V$ ,  $T_C = 25^\circ C$ ,  $P_{LO} = 6dBm$ ,  $f_{LO} = 890MHz$ ,  $f_{RF1} = 900MHz$ ,  $f_{RF2} = 901MHz$ ,  $f_{BB} = 10MHz$ ,  $P_{RF1} = P_{RF2} = -5dBm$ , DC Blocks and Mini-Circuits PSCJ-2-1 180° combiner at baseband outputs de-embedded from measurement unless otherwise noted. Test circuit with RF and LO ports impedance matched as in Figure 1.

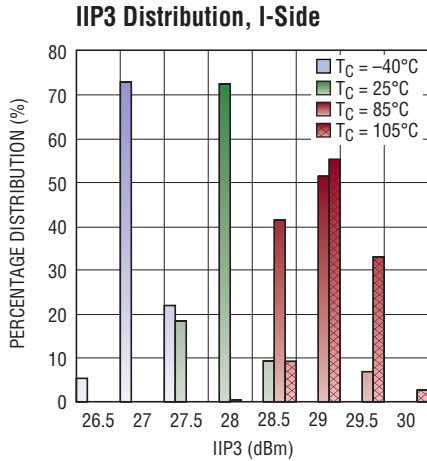

5584 G58

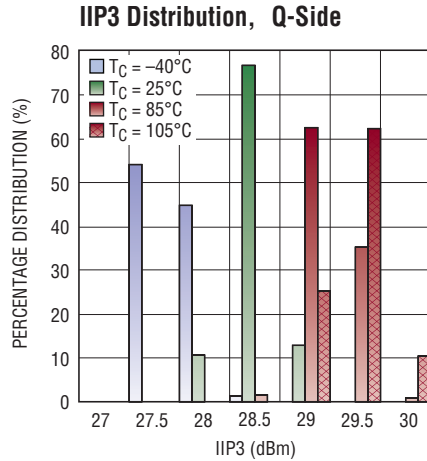

5584 G59

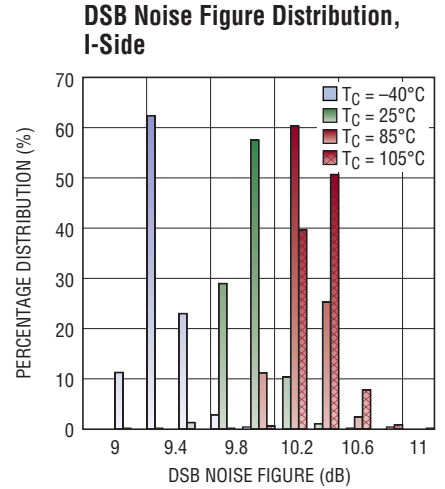

5584 G60

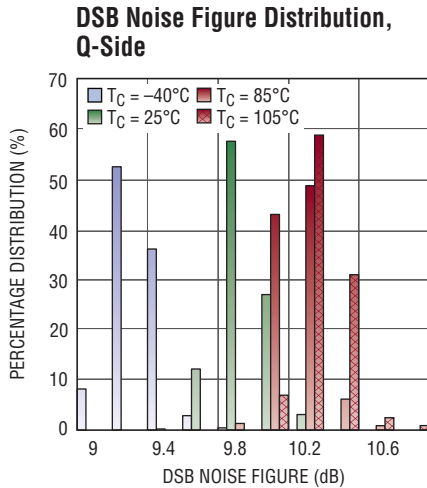

5584 G61

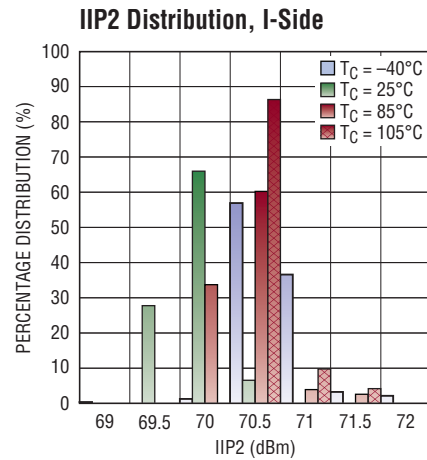

5584 G62

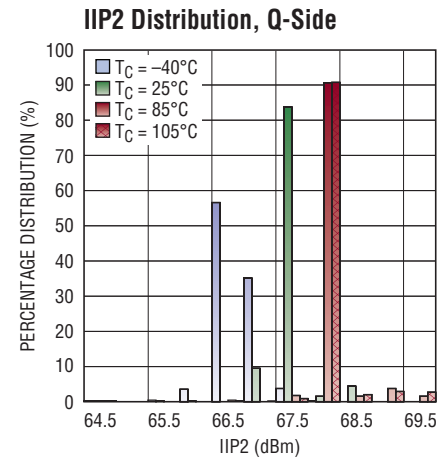

5584 G63

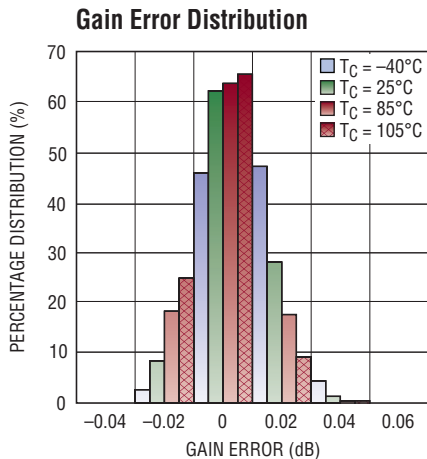

5584 G64

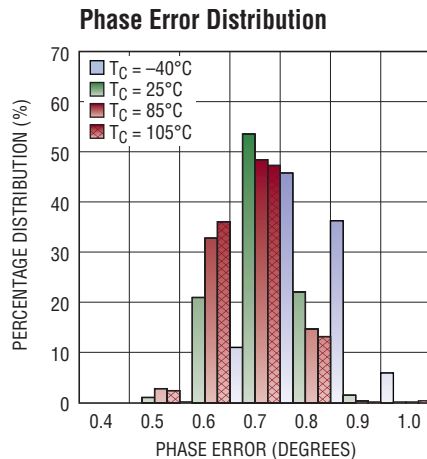

5584 G65

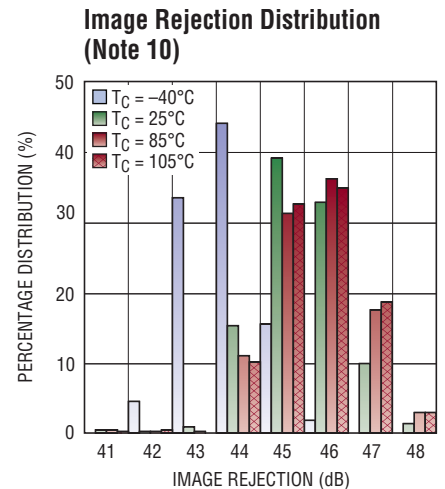

5584 G66

## PIN FUNCTIONS

**IP2Q, IP2I (Pin 1, Pin 4):** IIP2 Adjustment Analog Control Voltage Input for Q and I Channel. A decoupling capacitor is recommended on this pin. A low output resistance voltage source is recommended for driving these pins. These pins should be left floating if unused.

**DCOQ, DCOI (Pin 2, Pin 3):** DC Offset Analog Control Voltage Input for Q and I Channel. A decoupling capacitor is recommended on this pin. A low output resistance voltage source is recommended for driving these pins. These pins should be left floating if unused.

**RF<sup>+</sup>, RF<sup>-</sup> (Pin 5, Pin 6):** RF Differential Inputs. An external balun transformer with matching is used to obtain good return loss across the RF input frequency range. The RF pin should be DC-blocked with a 0.01 $\mu$ F coupling capacitor.

**GND (Pins 8, 13, 14, Exposed Pad Pin 25):** Ground. These pins must be soldered to the RF ground plane on the circuit board. The backside exposed pad ground connection should have a low inductance connection and good thermal contact to the printed circuit board ground plane using many through-hole vias. See Figures 2 and 3.

**EN (Pin 7):** Enable Pin. When the voltage on the EN pin is a logic high, the chip is completely turned on; the chip is completely turned off for a logic low. An internal 200k pull-down resistor ensures the chip remains disabled if there is no connection to the pin (open-circuit condition).

**V<sub>BIAS</sub> (Pin 9):** This pin can be pulled to ground through a resistor to lower the current consumption of the chip. See Applications Information.

**V<sub>CC</sub> (Pin 10):** Positive Supply Pin. This pin should be bypassed with shunt 0.01 $\mu$ F and 1 $\mu$ F capacitors.

**EDC (Pin 11):** DC Offset Adjustment Mode Enable Pin. When the voltage on the EDC pin is a logic high, the DC offset control circuitry is enabled. The circuitry is disabled for a logic low. An internal 200k pull-down resistor ensures the circuitry remains disabled if there is no connection to the pin (open-circuit condition).

**EIP2 (Pin 12):** IP2 Offset Adjustment Mode Enable Pin. When the voltage on the EIP2 pin is a logic high, the IP2 adjustment circuitry is enabled. The circuitry is disabled for a logic low. An internal 200k pull-down resistor ensures the circuitry remains disabled if there is no connection to the pin (open-circuit condition).

**LO<sup>+</sup>, LO<sup>-</sup> (Pin 15, Pin 16):** LO Inputs. External matching is required to obtain good return loss across the LO input frequency range. Can be driven single ended or differentially with an external transformer. The LO pins should be DC-blocked with 0.01 $\mu$ F coupling capacitors.

**V<sub>CAP</sub>, CMQ, CMI (Pin 17, Pin 18, Pin 19):** Common Mode Bypass Capacitor Pins. It is recommended that CMI and CMQ be connected to V<sub>CAP</sub> through 0.1 $\mu$ F capacitors. Nothing else should be connected to V<sub>CAP</sub> since it is connected to V<sub>CC</sub> inside the chip.

**I<sup>+</sup>, I<sup>-</sup>, Q<sup>+</sup>, Q<sup>-</sup> (Pin 23, Pin 22, Pin 21, Pin 20):** Differential Baseband Output Pins for the I Channel and Q Channel. The DC bias point is V<sub>CC</sub> – 1.5V for each pin. These pins must have an external 100 $\Omega$  or an inductor pull-up to V<sub>CC</sub>.

**REF (Pin 24):** Voltage Reference Input for Analog Control Voltage Pins. A decoupling capacitor is recommended on this pin. A low output resistance voltage source is recommended for driving this pin. This pin should be left floating if unused.

**BLOCK DIAGRAM**

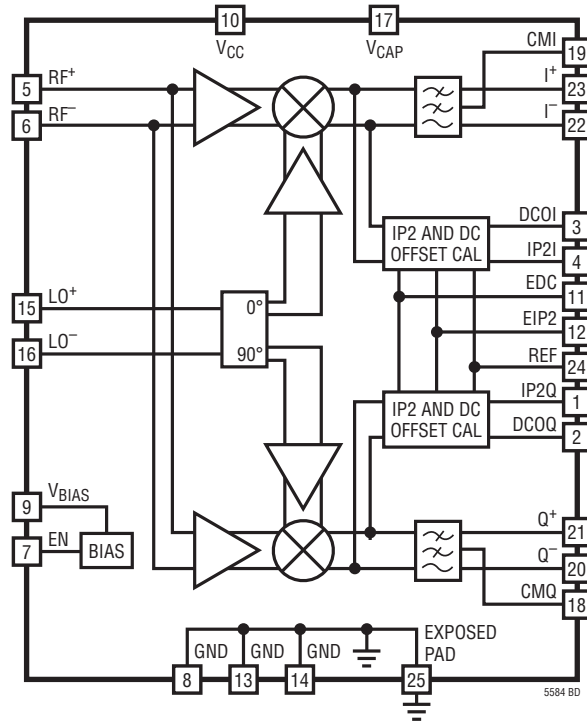

TEST CIRCUIT

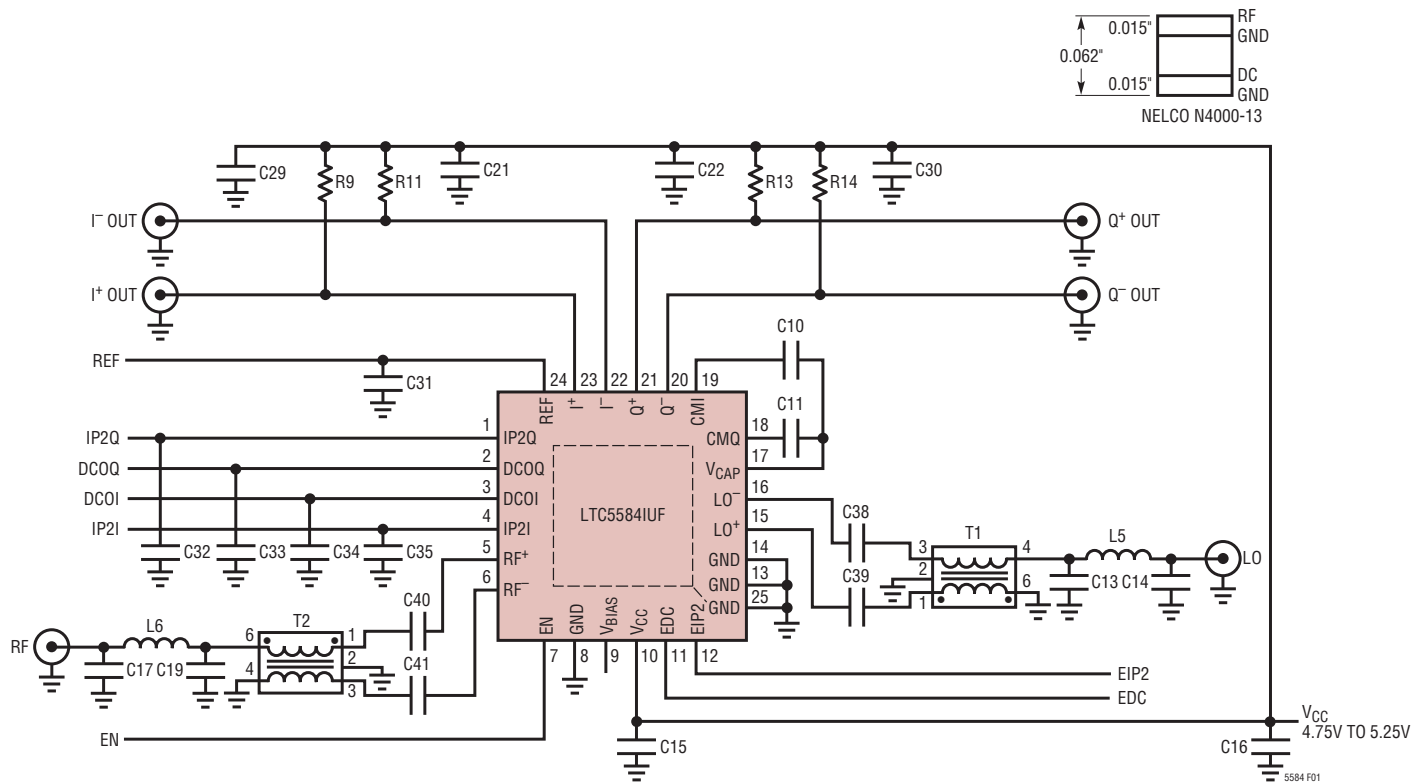

FREQUENCY RANGE	RF MATCH			LO MATCH		
	C17	L6	C19	C13	L5	C14
140MHz		68nH	8.0pF		82nH	
450MHz		15nH	1.0pF		12nH	4.0pF
900MHz	1.5pF	5.6nH		2.2pF	3.9nH	

REF DES	VALUE	SIZE	VENDOR	REF DES	VALUE	SIZE	VENDOR
C10, C11, C31-C35	0.1μF	0402	Murata	L5, L6	See Table	0402	Murata
C15, C38-C41	0.01μF	0402	Murata	R9, R11, R13, R14	100Ω	0402	Vishay
C13, C14, C17, C19	See Table	0402	Murata	T1, T2	1:1	AT224-1	Mini-Circuits TC1-1-13M+
C16, C21, C22, C29, C30	1μF	0402	Murata				

Figure 1. Test Circuit Schematic



## TEST CIRCUIT

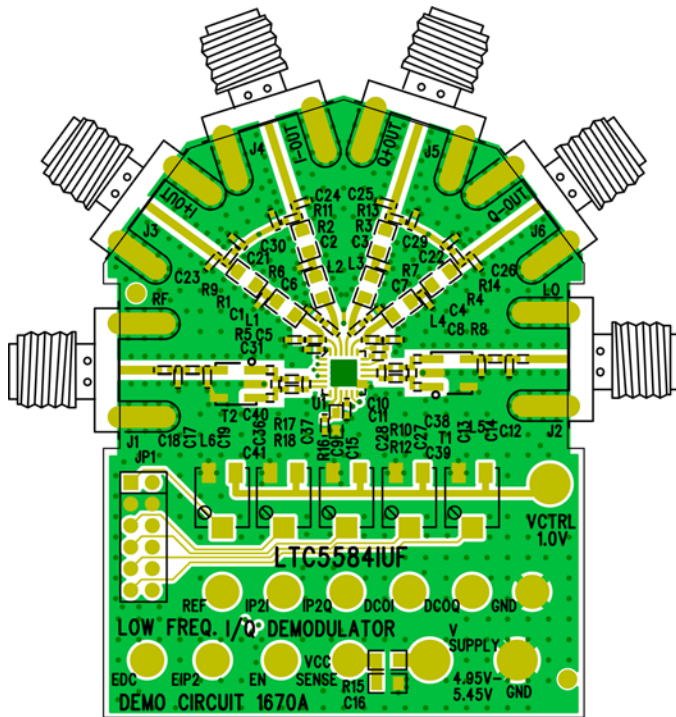

Figure 2. Component Side of Evaluation Board

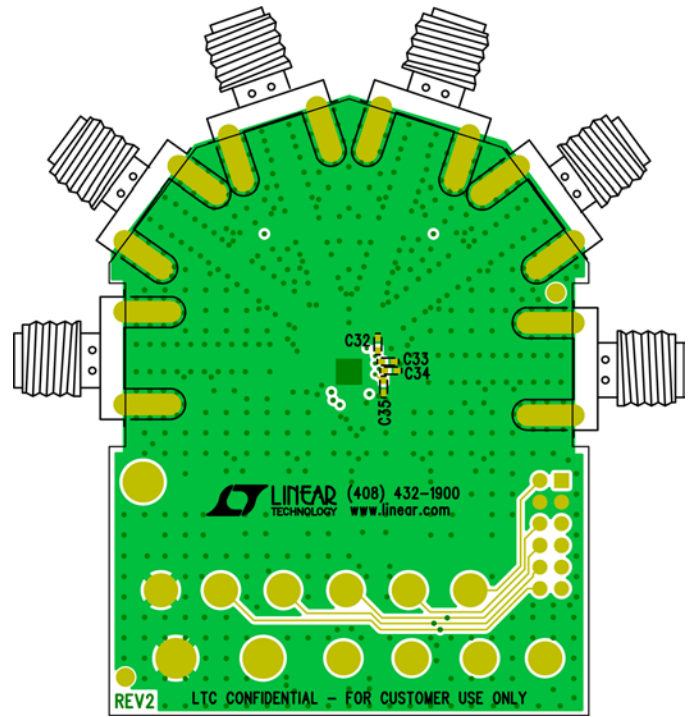

Figure 3. Bottom Side of Evaluation Board

## APPLICATIONS INFORMATION

The LTC5584 is an IQ demodulator designed for high dynamic range receiver applications. It consists of RF transconductance amplifiers, I/Q mixers, quadrature LO amplifiers, IIP2 and DC offset correction circuitry, and bias circuitry.

## Operation

As shown in the Block Diagram for the LTC5584, the RF signal is applied to the inputs of the RF transconductor V-to-I converters and is then demodulated into I/Q baseband signals using quadrature LO signals which are internally generated by a precision 90° phase shifter. The demodulated I/Q signals are lowpass filtered on-chip with a -3dB bandwidth of 530MHz. The differential outputs of the I-channel and Q-channel are well matched in amplitude and their phases are 90° apart.

## RF Input Port

Figure 4 shows the demodulator's differential RF input which consists of high linearity transconductance amplifiers (V-I converters). External DC voltage should not be applied to the RF input pins. DC current flowing into the pins may cause damage to the transconductance amplifiers. Series DC blocking capacitors should be used to couple the RF input pins to the RF signal source.

The RF input port can be externally matched over the operating frequency range with simple L-C matching. An input return loss greater than 10dB can be obtained over a fractional bandwidth of greater than 66% with this method. Figure 5 shows the RF input return loss for various matching component values. Table 1 shows the differential and single-ended S parameters for the RF input without using any external matching components. The input transmission line length and balun are de-embedded from the measurement.

## APPLICATIONS INFORMATION

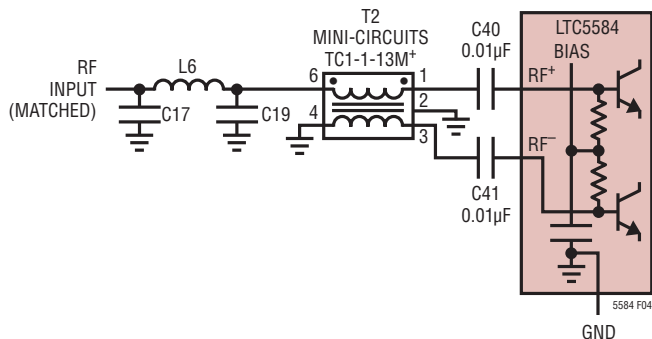

Figure 4: Simplified Schematic of the RF Interface

Table 1. RF Input S Parameters

FREQUENCY (MHz)	S11 (DIFFERENTIAL)		S11 (SINGLE ENDED)	
	MAG	ANGLE(°)	MAG	ANGLE(°)
10	0.5657	-2.416	0.3253	-5.287
20	0.55	-2.674	0.3055	-5.761
40	0.5391	-2.288	0.2938	-4.499
80	0.5349	-2.268	0.2984	-4.517
140	0.5336	-2.946	0.3097	-9.805
200	0.5329	-3.836	0.2989	-16.34
300	0.5317	-5.453	0.2732	-21.46
400	0.5301	-7.128	0.2614	-24.35
450	0.5292	-7.975	0.2583	-25.79
500	0.5282	-8.826	0.2562	-27.29
600	0.5258	-10.54	0.2536	-30.43
700	0.523	-12.25	0.2523	-33.66
800	0.5199	-13.97	0.2517	-36.88
900	0.5164	-15.7	0.2519	-39.97
1000	0.5124	-17.43	0.2529	-42.85
1100	0.5082	-19.17	0.2556	-45.49
1200	0.5035	-20.91	0.2609	-48.02
1300	0.4985	-22.66	0.2693	-50.73
1400	0.4931	-24.42	0.2804	-53.98
1500	0.4873	-26.19	0.2925	-57.96
1600	0.4812	-27.97	0.3035	-62.52
1700	0.4747	-29.77	0.3122	-67.36
1800	0.4678	-31.58	0.3187	-72.19
1900	0.4606	-33.41	0.3235	-76.87
2000	0.453	-35.26	0.3271	-81.36

Note: Differential S parameters measured with 1:1 balun and single-ended S parameters measured with 50Ω termination on unused port.

Larger bandwidths can be obtained by using more elements. For example Figure 6 shows an L-C match having a bandwidth of about 98% where return loss is >10dB. Figure 7 shows the RF input return loss for the wide bandwidth match.

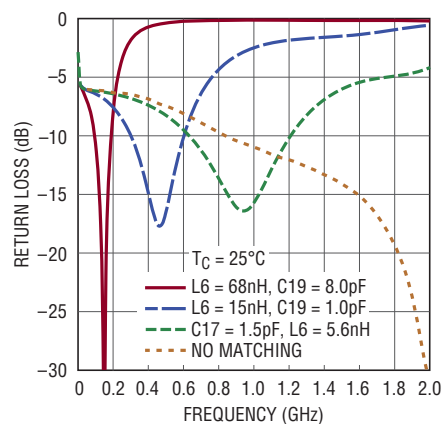

Figure 5. RF Input Return Loss

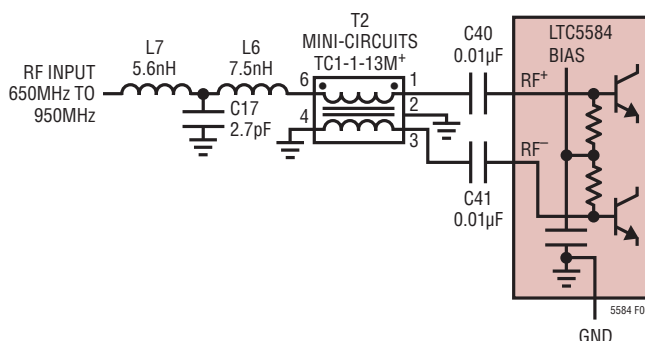

Figure 6. Wide Bandwidth RF Input Match

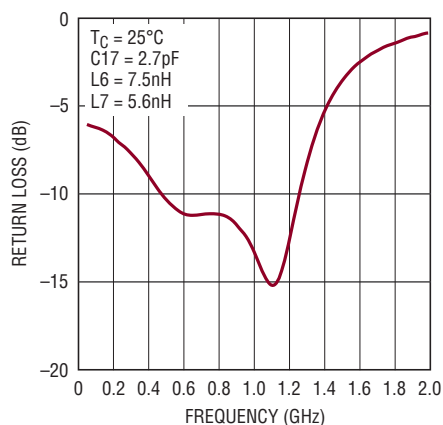

Figure 7. RF Input Return Loss for Wideband Match

## APPLICATIONS INFORMATION

### Broadband Performance

To get an idea of the broadband performance of the LTC5584, a 6dB pad can be put on the RF and LO ports, and the ports can be left unmatched. The measured RF performance for this configuration is shown in Figures 8, 9, 10 and 11 with the 6dB pad de-embedded. The RF tone spacing is 1MHz, and  $f_{LO}$  is 10MHz lower than  $f_{RF}$ . The conversion gain is lower than under the impedance matched condition, and correspondingly the P1dB, IIP3, and NF are higher. As shown, the part can be used at frequencies outside its specified operating range with reduced conversion gain and higher NF.

### LO Input Port

The demodulator's LO input interface is shown in Figure 12. The input consists of a high precision quadrature phase shifter which generates  $0^\circ$  and  $90^\circ$  phase shifted LO signals for the LO buffer amplifiers to drive the I/Q mixers. DC blocking capacitors are required on the  $LO^+$  and  $LO^-$  inputs.

The differential and single-ended LO input S parameters with the input transmission lines and balun de-embedded are listed in Table 2.

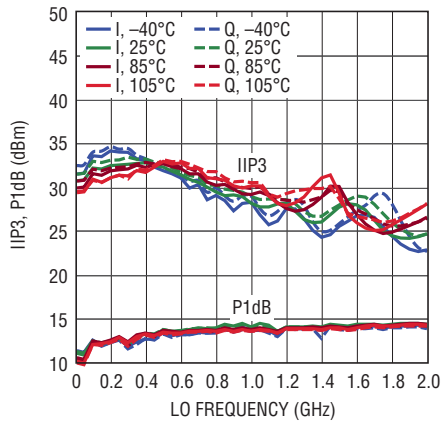

Figure 8. Broadband IIP3 and IP1dB

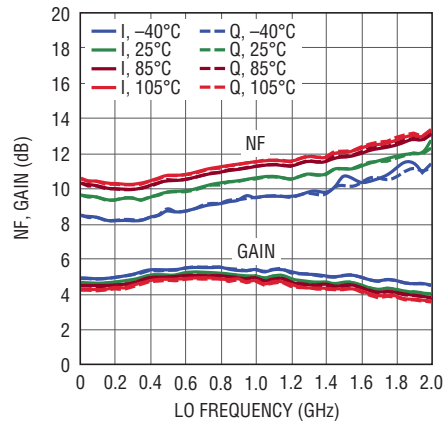

Figure 10. Broadband NF and Gain

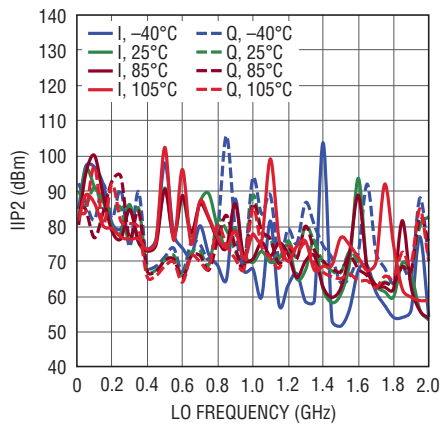

Figure 9. Broadband IIP2

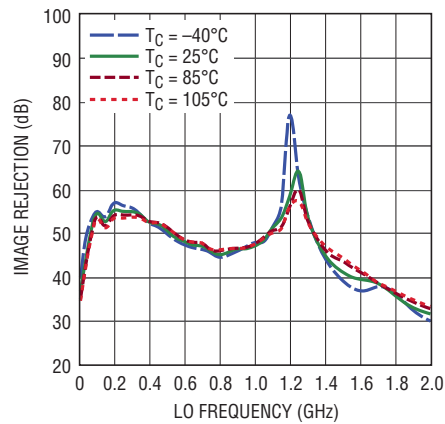

Figure 11. Broadband Image Rejection

## APPLICATIONS INFORMATION

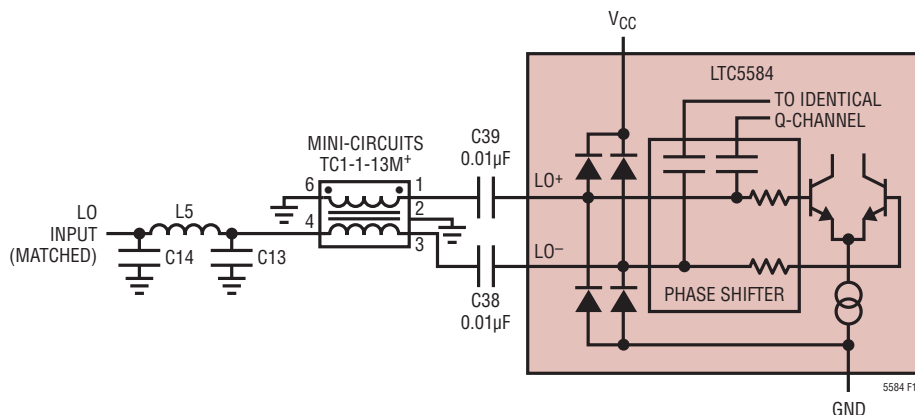

Figure 12. Simplified Schematic of LO Input Interface with External Matching Components

Table 2. LO Input S-Parameters

FREQUENCY (MHz)	S11 (DIFFERENTIAL)		S11 (SINGLE ENDED)	
	MAG	ANGLE(°)	MAG	ANGLE(°)
10	0.8138	-1.736	0.7869	-1.896
20	0.8485	-6.615	0.8127	-6.425
40	0.7857	-18.67	0.7382	-16.33
80	0.6608	-25.61	0.6356	-20.1
140	0.5968	-33.93	0.5801	-25.43
200	0.5515	-42.29	0.5395	-30.5
300	0.4932	-54.56	0.4911	-37.49
400	0.4538	-65.21	0.4606	-43.5
450	0.4396	-70.18	0.4498	-46.36
500	0.4283	-75.01	0.441	-49.17
600	0.412	-84.37	0.4278	-54.67
700	0.4018	-93.45	0.4187	-60.04
800	0.3958	-102.3	0.4124	-65.26
900	0.3928	-110.9	0.4083	-70.32
1000	0.3921	-119.2	0.4059	-75.21
1100	0.3931	-127.2	0.405	-79.94
1200	0.3955	-135	0.4052	-84.52
1300	0.399	-142.4	0.4064	-88.94
1400	0.4035	-149.5	0.4084	-93.23
1500	0.4088	-156.3	0.411	-97.37
1600	0.4148	-162.9	0.4143	-101.4
1700	0.4213	-169.1	0.4181	-105.3
1800	0.4283	-175.1	0.4224	-109.1
1900	0.4357	-180.8	0.4271	-112.8
2000	0.4435	-186.2	0.4322	-116.4

Note: Differential S parameters measured with 1:1 balun and single-ended S parameters measured with 50Ω termination on unused port.

Figure 13 shows LO input return loss using the Mini-Circuits TC1-1-13M<sup>+</sup> 1:1 balun with various matching component values.

For optimum IIP2 and large-signal NF performance the LO inputs should be driven differentially with a 1:1 balun such as the Mini-Circuits TC1-1-13M<sup>+</sup> or M/A Com ETC1-1-13. As shown in Figure 14, the LO input can also be driven single-ended from either the LO<sup>+</sup> or LO<sup>-</sup> input. The unused port should be DC-blocked and terminated with a 50Ω load. Figure 15 compares the uncalibrated IIP2 performance of single ended versus differential LO drive.

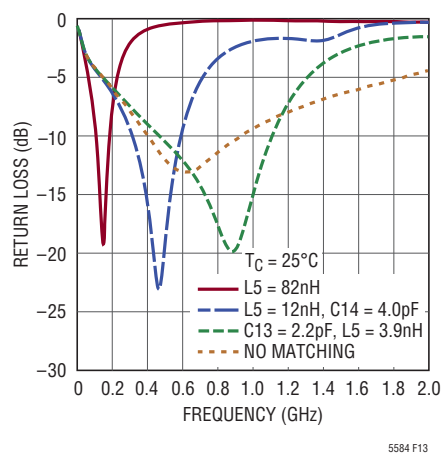

Figure 13. LO Input Return Loss

APPLICATIONS INFORMATION

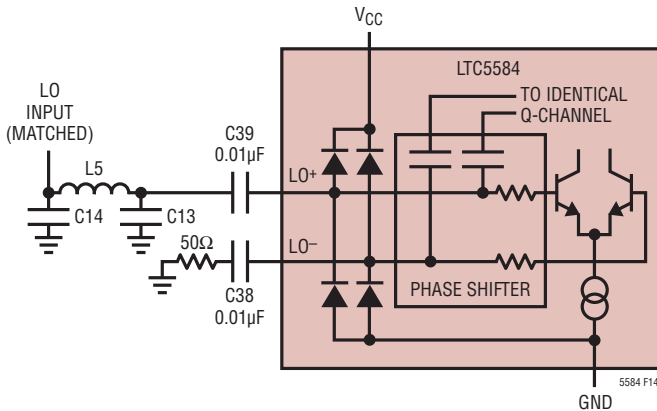

Figure 14. Recommended Single-Ended LO Input Configuration

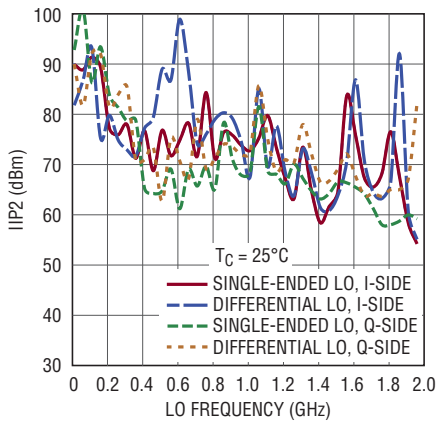

Figure 15. Broadband IIP2 with Differential and Single-Ended LO Drive

I-Channel and Q-Channel Outputs

The phase relationship between the I-channel output signal and the Q-channel output signal is fixed. When the LO input frequency is higher (or lower) than the RF input frequency, the Q-channel outputs (Q<sup>+</sup>, Q<sup>-</sup>) lead (or lag) the I-channel outputs (I<sup>+</sup>, I<sup>-</sup>) by 90°.

Each of the I-channel and Q-channel outputs is internally connected to V<sub>CC</sub> through a 100Ω resistor. In order to maintain an output DC bias voltage of V<sub>CC</sub> – 1.5V, external 100Ω pull-up resistors or equivalent 15mA DC current sources are required. Each single-ended output has an impedance of 100Ω in parallel with a 6pF internal capacitor. With an external 100Ω pull-up resistor this forms a lowpass filter with a –3dB corner frequency at 530MHz.

The outputs can be DC coupled or AC coupled to external loads. The voltage conversion gain is reduced by the external load by:

$$20\text{Log}_{10} \left( \frac{1}{2} + \frac{50\Omega}{R_{\text{PULL-UP}} \parallel R_{\text{LOAD(SE)}}} \right) \text{dB}$$

when the output port is terminated by R<sub>LOAD(SE)</sub>. For instance, the gain is reduced by 6dB when each output pin is connected to a 50Ω load (or 100Ω differentially). The output should be taken differentially (or by using differential-to-single-ended conversion) for best RF performance, including NF and IIP2. When no external filtering or matching components are used, the output response is determined by the loading capacitance and the total resistance loading the outputs. The –3dB corner frequency, f<sub>C</sub>, is given by the following equation:

$$f_C = [2\pi(R_{\text{LOAD(SE)}} \parallel 100\Omega \parallel R_{\text{PULL-UP}}) (6\text{pF})]^{-1}$$

Figure 16 shows the actual measured output response with various load resistances.

Figure 17 shows a simplified model of the I, Q outputs with a 100Ω differential load and 100Ω pull-ups. The –1dB bandwidth in this configuration is about 520MHz, or about twice the –1dB bandwidth with no load.

Figure 18 shows a simplified model of the I, Q outputs with a L-C matching network for bandwidth extension. Capacitor C<sub>S</sub> serves to filter common mode LO switching noise immediately at the demodulator outputs. Capacitor C<sub>C</sub> in combination with inductor L<sub>S</sub> is used to peak the

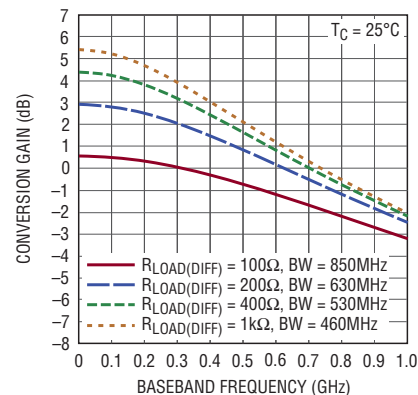

Figure 16. Conversion Gain Baseband Output Response with R<sub>LOAD(DIFF)</sub> = 100Ω, 200Ω, 400Ω and 1k and R<sub>PULL-UP</sub> = 100Ω



## APPLICATIONS INFORMATION

output response to give greater bandwidth of 650MHz. In this case, capacitor  $C_C$  was chosen as a common mode capacitor instead of a differential mode capacitor to increase rejection of common mode LO switching noise.

When AC output coupling is used, the resulting highpass filter's  $-3\text{dB}$  roll-off frequency,  $f_C$ , is defined by the R-C constant of the external AC coupling capacitance,  $C_{AC}$ , and the differential load resistance,  $R_{LOAD(DIFF)}$ :

$$f_C = [2\pi \cdot R_{LOAD(DIFF)} \cdot C_{AC}]^{-1}$$

Care should be taken when the demodulator's outputs are DC coupled to the external load to make sure that the I/Q mixers are biased properly. If the current drain from the outputs exceeds about 6mA, there can be significant degradation of the linearity performance. Keeping the common mode output voltage of the demodulator above 3.15V,

with a 5V supply, will ensure optimum performance. Each output can sink no more than 30mA when the outputs are connected to an external load with a DC voltage higher than  $V_{CC} - 1.5\text{V}$ .

In order to achieve the best IIP2 performance, it is important to minimize high frequency coupling among the baseband outputs, RF port, and LO port. Although it may increase layout complexity, routing the baseband output traces on the backside of the PCB can improve uncalibrated IIP2 performance. Figure 19 shows the alternate layout having the baseband outputs on the backside of the PCB.

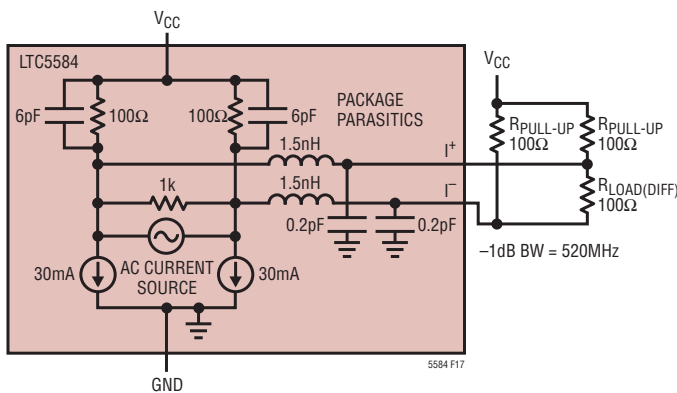

Figure 17. Simplified Model of the Baseband Output

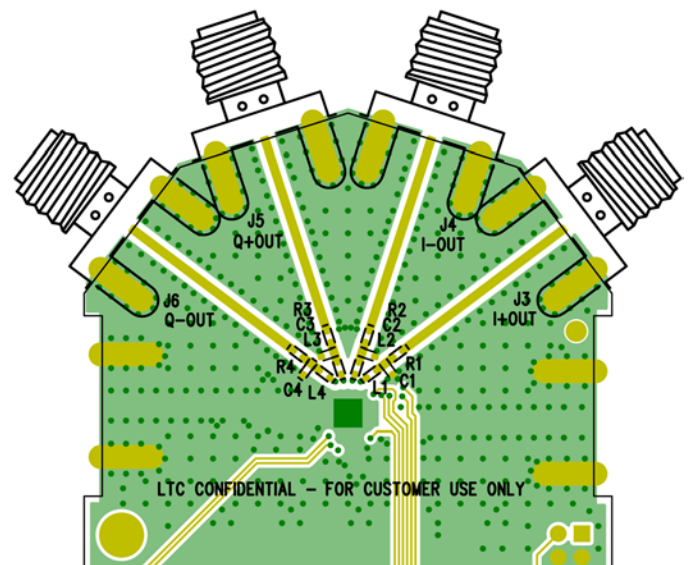

Figure 19. Alternate Layout of PCB with Baseband Outputs on the Backside

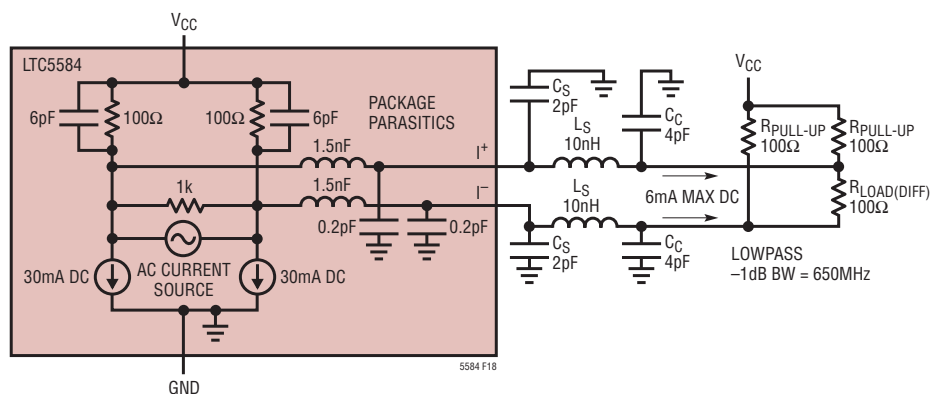

Figure 18. Simplified Model of the Baseband Output Showing Bandwidth Extension with External L, C Matching

## APPLICATIONS INFORMATION

### Analog Control Voltage Pins

Figure 20 shows the equivalent circuit for the DCOI, DCOQ, IP2I, and IP2Q pins. Internal temperature compensated 62.5 $\mu$ A current sources keep these pins biased at a nominal 500mV through 8k resistors. A low impedance voltage source with a source resistance of less than 200 $\Omega$  is recommended to drive these pins.

As shown in Figure 21, the REF pin is similar to the DCOI pin, but the bias current source is 250 $\mu$ A, and the internal resistance is 2k. If this pin is left disconnected, it will self-bias to 500mV. A low impedance voltage source with a source resistance of less than 200 $\Omega$  is recommended to drive this pin. The control voltage range of the DCOI, DCOQ, IP2I and IP2Q pins is set by the REF pin. This range is equal to 0V to twice the voltage on the REF pin, whether internally or externally applied.

It is recommended to decouple any AC noise present on the signal lines that connect to the analog control-voltage inputs. A shunt capacitor to ground placed close to these pins can provide adequate filtering. For instance, a value of 1000pF on the DCOI, DCOQ, IP2I and IP2Q pins will provide a corner frequency of around 6 to 7MHz. A similar corner frequency can be obtained on the REF pin with a value of 3900pF. Using larger capacitance values such as 0.1 $\mu$ F is recommended on these pins unless a faster control response is needed. Figure 22 shows the input response  $-3$ dB bandwidth for the pins versus shunt capacitance when driven from a 50 $\Omega$  source.

### DC Offset Adjustment Circuitry

Any sources of LO leakage to the RF input of a direct conversion receiver will contribute to the DC offsets of its baseband outputs. The LTC5584 features DC offset adjustment circuitry to reduce such effects. When the EDC pin is a logic high the circuitry is enabled and the resulting DC offset adjustment range is typically  $\pm 20$ mV. In a typical direct conversion receiver application, DC offset calibration will be done periodically at a time when no receive data is present and when the receiver DC levels have sufficiently settled.

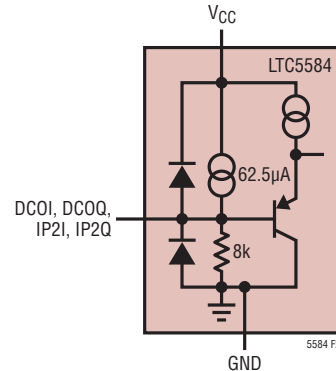

Figure 20. Simplified Schematic of the Interface for the DCOI, DCOQ, IP2I and IP2Q Pins

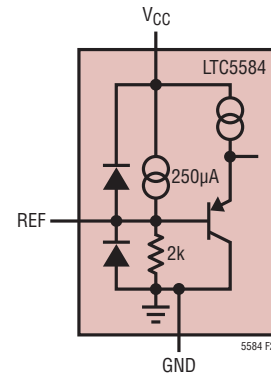

Figure 21. Simplified Schematic of the REF Pin Interface

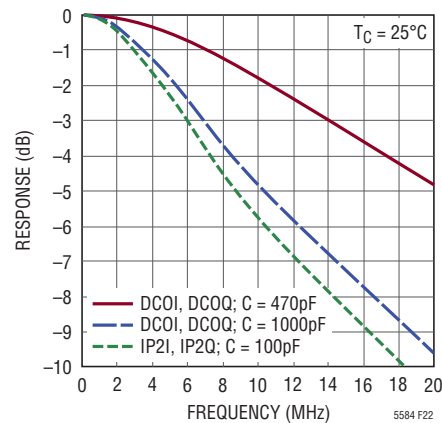

Figure 22. Input Response Bandwidth for the DCOI, DCOQ, IP2I and IP2Q Pins



## APPLICATIONS INFORMATION

### DC Offset Adjustment Example

Figure 23 shows a typical direct conversion receive path having a DSP feedback path for DC offset adjustment. Any sources of LO leakage to the RF input of the LTC5584 demodulator will contribute to the DC offset of the receiver. This includes both static and dynamic DC offsets. If the coupling is static in nature due to fixed board-level leakage paths, the resulting DC offset does not typically need to be adjusted at a high repetition rate. Dynamic DC offsets due to transmitter transient leakage or antenna reflection can be much harder to correct for and will require a faster update rate from the DSP.

LO leakage into the RF port of the demodulator causes a DC offset at the baseband outputs which is then multiplied by the gain in the baseband path. The usable ADC voltage window will be reduced by the amplified DC offset, resulting in lower dynamic range. Using DSP, this DC offset value can be averaged and sampled at a given update rate and then a 1-D minimization algorithm can be applied before a new DCOI or DCOQ control signal is generated to minimize the offset. The 1-D minimization algorithm can be implemented in many ways such as golden-section search, backtracking, or Newton's method.

### IM2 Adjustment Circuitry

The LTC5584 also contains circuitry for the independent adjustment of IM2 levels on the I and Q channels. When the EIP2 pin is a logic high, this circuitry is enabled and the IP2I and IP2Q analog control voltage inputs are able to adjust the IM2 level. The IM2 level can be effectively minimized over a large range of the baseband bandwidth. The circuitry has an effective baseband frequency upper

limit of about 200MHz. Any IM2 component that falls in this frequency range can be minimized. Beyond this frequency, the gain of the IM2 correction amplifier falls off appreciably and the circuit no longer improves IP2 performance. The lower baseband frequency limit of the IM2 adjustment circuitry is set by the common mode reference decoupling capacitor at the CMI and CMQ pins. Below this frequency the circuit can not minimize the IM2 component.

Figure 24 shows the CMI (and identical CMQ) pin interface. These pins have an internal 40pF decoupling capacitance to  $V_{CC}$ , to provide a reference for the IP2 adjustment circuitry. The lower 3dB frequency limit,  $f_C$ , of the circuitry is set by the following equation:

$$f_C = [2\pi \cdot 500(40\text{pF} + C_{CM(EXT)})]^{-1}$$

Without any external capacitor on the CMI or CMQ pin the lower limit is 8MHz. By adding a 0.1 $\mu\text{F}$  capacitor,  $C_{CM(EXT)}$ , between the CMI and CMQ pins to  $V_{CAP}$ , the lower -3dB frequency corner can be reduced to 3kHz. Figure 25 shows IIP2 as a function of RF frequency spacing versus common mode decoupling capacitance values of 0.1 $\mu\text{F}$  and 1500pF. There is effectively no limit on the size of this capacitor,

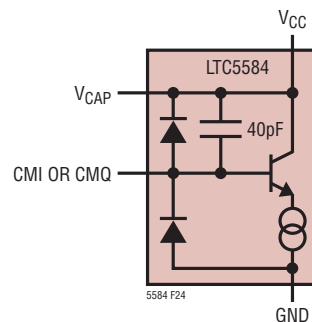

Figure 24. Equivalent Circuit of the CMI and CMQ Pin Interfaces

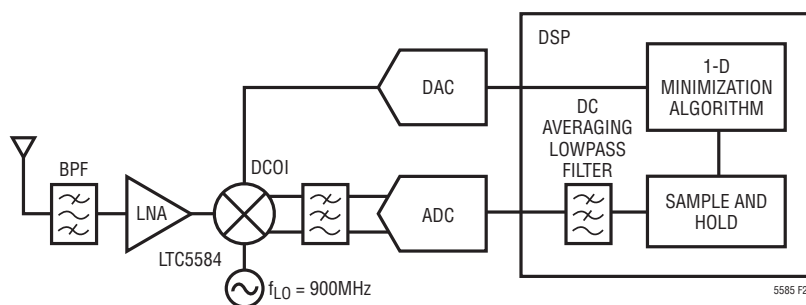

Figure 23. Block Diagram of a Receiver with a DSP Feedback Loop for DC Offset Adjustment

## APPLICATIONS INFORMATION

other than the impact it has on enable time for the IM2 circuitry to be operational. When the chip is disabled, there is no current in the I or Q mixers, so the common mode output voltage will be equal to  $V_{CC}$  (if no DC common mode current is being drawn by external baseband circuitry such as a baseband amplifier). When the chip is enabled, the off-chip common mode decoupling capacitor must charge up through a  $500\Omega$  resistor. The time constant for this is essentially  $500\Omega$  times the common mode decoupling capacitance value. For example, with a  $0.01\mu\text{F}$  capacitor this wait time is approximately  $30\mu\text{s}$ . Figure 26 shows the pulsed enable response of the common-mode output voltage with  $0.01\mu\text{F}$  on the CMI and CMQ pins.

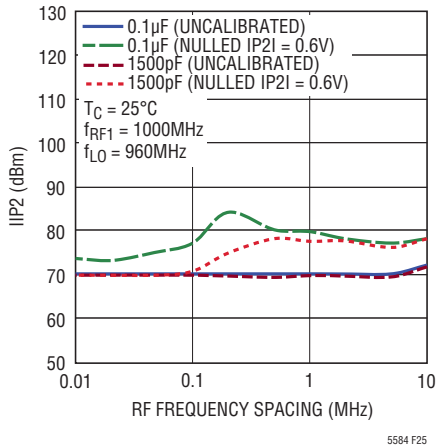

Figure 25. IIP2 vs Common Mode Decoupling Capacitance

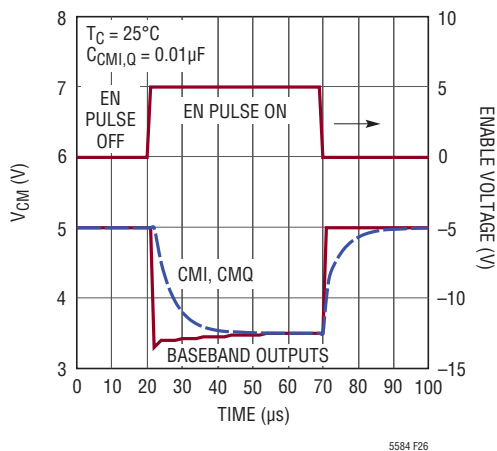

Figure 26. Common Mode Output Voltage with a Pulsed Enable

### IM2 Suppression Example

IM2 adjustment circuitry can be used in a typical transceiver loop-back application as shown in Figure 27. In this example a 2-tone SSB training source of  $f_1 = 20\text{MHz}$  and  $f_2 = 21\text{MHz}$  is generated in DSP and upconverted by the LTC5588-1 quadrature modulator to RF tones at  $870\text{MHz}$  and  $871\text{MHz}$  using an LO source at  $850\text{MHz}$ . A narrowband RF filter is required to remove the IM2 component generated by the LTC5588-1. During the loopback test these RF tones are routed through high isolation switches and an attenuation pad to the LTC5584 demodulator input. The tones are then downconverted by the same LO source at  $850\text{MHz}$  to produce two tones at the baseband outputs of  $20\text{MHz}$  and  $21\text{MHz}$  plus an IM2 impairment signal at  $1\text{MHz}$ . After baseband channel filtering and amplification the output of the ADC is filtered by a  $1\text{MHz}$  bandpass filter in DSP to isolate the IM2 tone. The power in this tone is calculated in DSP and then a 1-D minimization algorithm is applied to calculate the correction signal for the IP2I control voltage pin. The 1-D minimization algorithm can be implemented in many ways such as golden-section search, backtracking or Newton's method.

### Enable Interface

A simplified schematic of the EN pin is shown in Figure 28. The enable voltage necessary to turn on the LTC5584 is  $2\text{V}$ . To disable or turn off the chip, this voltage should be below  $0.3\text{V}$ . If the EN pin is not connected, the chip is disabled.

Figures 29 and 30 show the simplified schematics for the EDC and EIP2 pins.

It is important that the voltage applied to the EN, EDC and EIP2 pins should never exceed  $V_{CC}$  by more than  $0.3\text{V}$ . Otherwise, the supply current may be sourced through the upper ESD protection diode connected at the pin. Under no circumstances should voltage be applied directly to the enable pins before the supply voltage is applied to the  $V_{CC}$  pin. If this occurs, damage to the IC may result. A  $1\text{k}$  resistor in series with the enable pin can be used to limit current.

### Reducing Power Consumption

Figure 31 shows the simplified schematic of the  $V_{BIAS}$  interface. The  $V_{BIAS}$  pin can be used to lower the mixer



APPLICATIONS INFORMATION

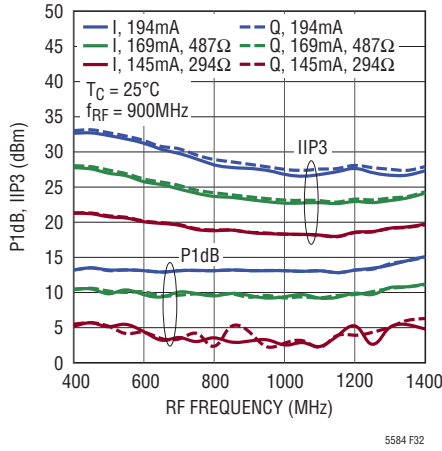

Figure 32. IIP3 and P1dB vs DC Current and VBIAS Resistor Value

900MHz Receiver Application

Figure 33 shows a typical receiver application consisting of the chain of LNA, demodulator, lowpass filter, ADC driver, and ADC. Total DC power consumption is about 2.1W. Full-scale power at the RF input is  $-8.4\text{dBm}$ . The Chebychev lowpass filter with unequal terminations is designed using the method shown in the appendix. Filter component values are then adjusted for the best overall response and available component values. A positive voltage gain slope with frequency is necessary to compensate for the roll-off contributed by the ADC Driver and Anti-Alias Filter. From the chain analysis shown in Figure 34, the IIP3-NF dynamic range figure of merit (FOM) is 5.3dB at the LNA input, 11.3dB at the demodulator input, and 16.8dB at the ADC driver amp input.

The measured 6th order lowpass baseband response is shown in Figure 35.

The receiver spurious free dynamic range (SFDR) in terms of FOM can be calculated using the following equations:

$$\text{FOM} = \text{IIP3} - \text{NF}$$

$$\text{SFDR} = 2/3(\text{FOM} - P_0)$$

$$P_0 = -174\text{dBm} + 10\text{Log}_{10}(\text{BW}|_{\text{Hz}})$$

where  $P_0$  is the input noise power and  $-174\text{dBm}$  is the input thermal noise power in a 1Hz bandwidth. A measured 2-tone output spectrum at 890MHz is shown in Figure 36. IIP3 is calculated from the 2-tone IM3 levels:

$$\text{IIP3} = (-6.929 - (-88.33))/2 - 15.4$$

$$\text{IIP3} = 25.3\text{dBm}$$

For this example, receiver noise floor is approximated by a measurement from 28MHz to 36MHz offset frequency, where adequate filtering for RF and LO signals was possible. Using the test data from Figure 36, the receiver noise figure for the I-channel (Ch 1) is calculated using the  $-8.4\text{dBm}$  input power, 15kHz bin width, 40MHz bandwidth, and  $-108\text{dBFS}$  measured in-band noise floor:

$$\text{SNR}_{\text{IN}} = P_{\text{IN}} - P_0$$

$$\text{SNR}_{\text{IN}} = -8.4 - (-174 + 76) = 89.6\text{dB}$$

$$\text{SNR}_{\text{OUT}} = -10 \text{Log}_{10}(\text{BinW}/\text{BW}) - \text{Floor}$$

$$\text{SNR}_{\text{OUT}} = -43.3 + 108 = 73.7\text{dB}$$

$$\text{NF} = \text{SNR}_{\text{IN}} - \text{SNR}_{\text{OUT}}$$

$$\text{NF} = 89.6 - 73.7 = 15.9\text{dB}$$

Finally, the receiver spurious free dynamic range can be calculated using the measured data at 890MHz:

$$\text{SFDR} = 2(\text{IIP3} - \text{NF} - P_0)/3$$

$$\text{SFDR} = 2(25.3 - 15.9 - (-174 + 76))/3$$

$$\text{SFDR} = 73\text{dB}$$

APPLICATIONS INFORMATION

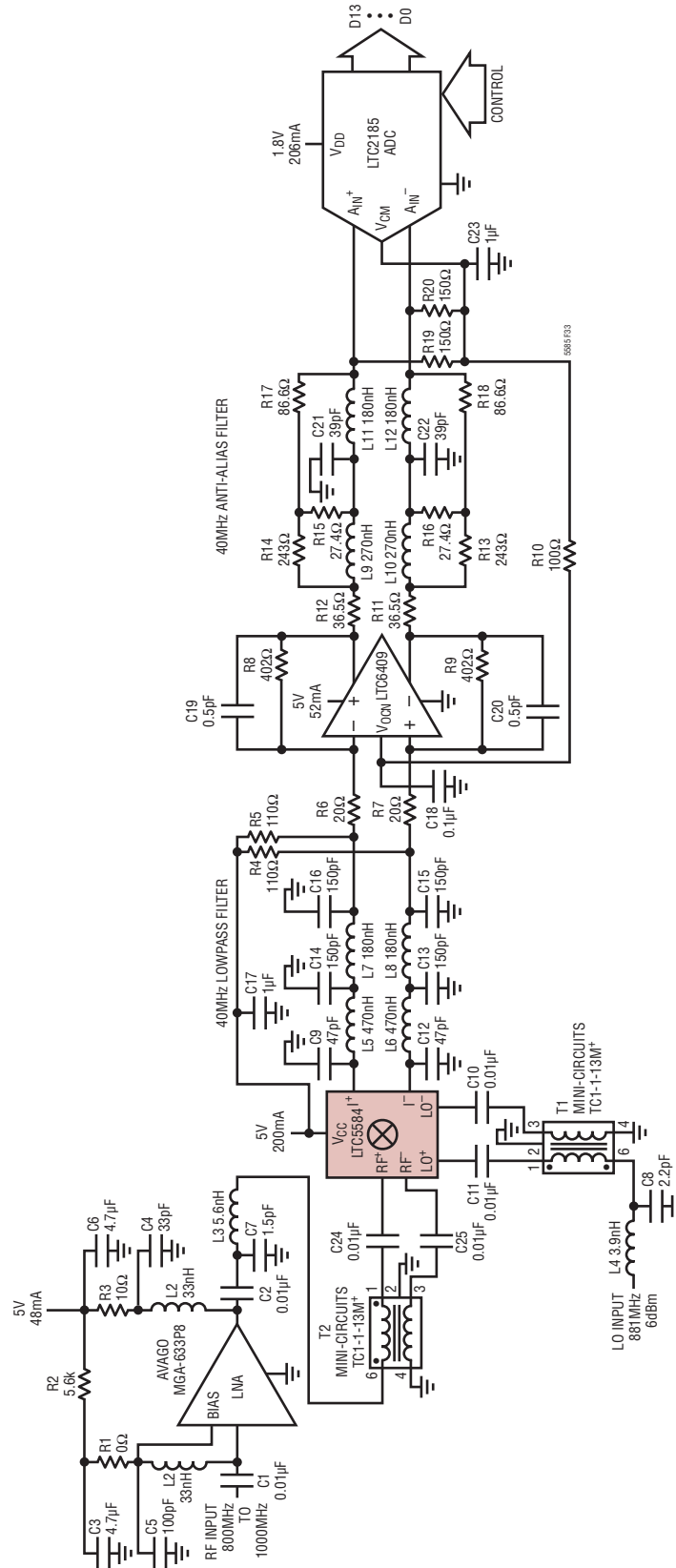

Figure 33. Simplified Schematic of 900MHz Receiver, (Only I-Channel Is Shown)

APPLICATIONS INFORMATION

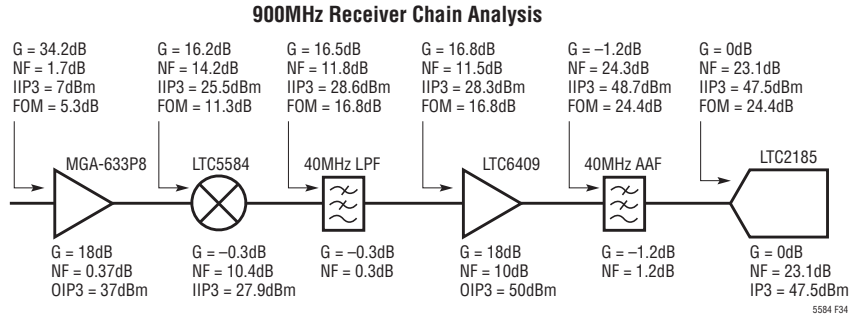

Figure 34. 900MHz Receiver Chain Analysis

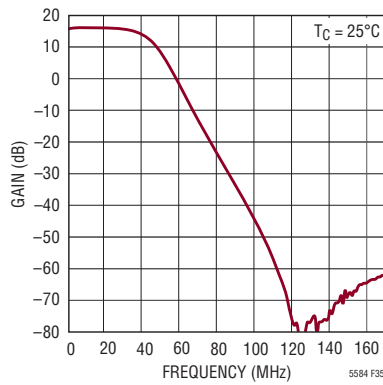

Figure 35. Baseband Gain Response without LNA

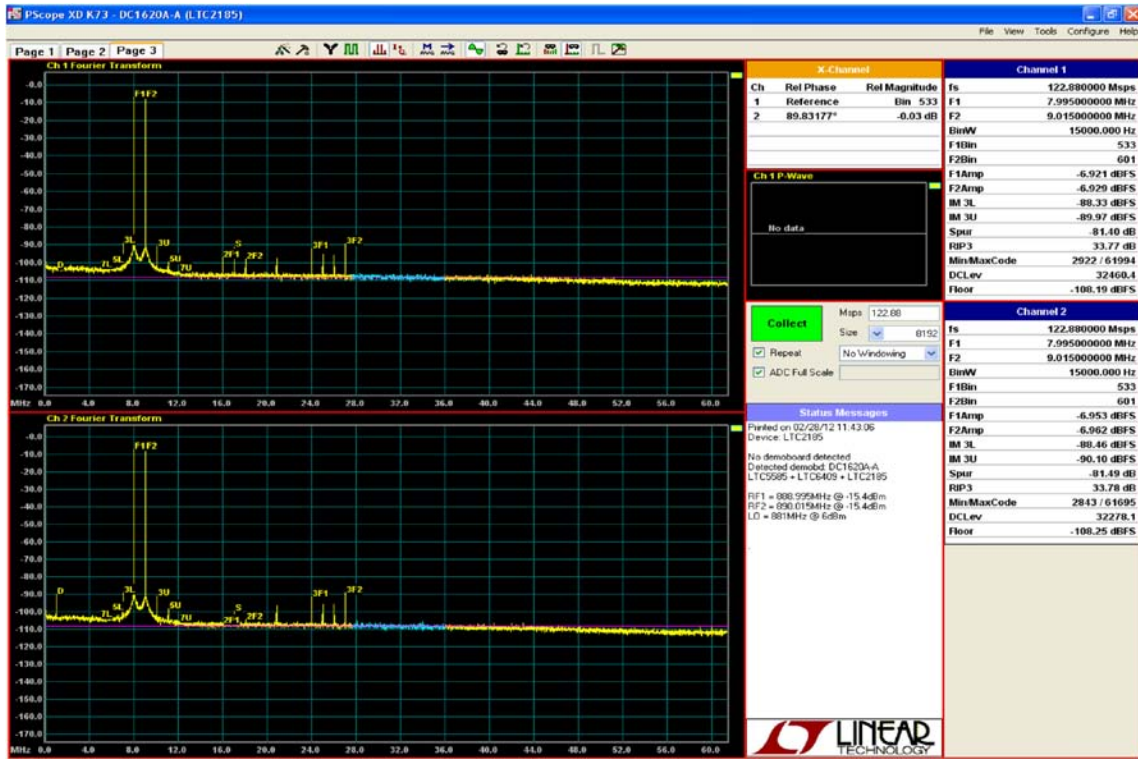

Figure 36.  $f_{RF} = 889\text{MHz}$  and  $890\text{MHz}$  2-Tone Receiver Test,  $f_{LO} = 881\text{MHz}$ . Ch.1 Is the I Channel and Ch.2 Is the Q Channel. Tested without LNA



## APPENDIX

### Chebyshev Filter Synthesis with Unequal Terminations

To synthesize Chebyshev filters with unequal terminations, two equally terminated filters are synthesized at the two different impedance levels and the resulting networks are joined using the Impedance Bisection Theorem[1]. This method only works with symmetrical odd-order filters. The general lowpass prototype element values are generated by the method shown [2]:

$$\beta = \ln \left[ \coth \frac{L_{Ar}|_{dB}}{17.37} \right]$$

$$\gamma = \sinh \left( \frac{\beta}{2n} \right)$$

$$a_k = \sin \frac{\pi(2k-1)}{2n}, \quad k = 1, 2, \dots, n$$

$$b_k = \gamma^2 + \sin^2 \frac{\pi k}{n}, \quad k = 1, 2, \dots, n$$

where  $L_{Ar}|_{dB}$  is the passband ripple in dB, and  $n$  is the filter order.

The prototype element values will be:

$$g_1 = \frac{2a_1}{\gamma}$$

$$g_k = \frac{4a_k a_{k-1}}{b_{k-1} g_{k-1}}, \quad k = 1, 2, \dots, n$$

$$g_{n+1} = 1 \text{ for } n \text{ odd}$$

$$g_{n+1} = \coth^2 \left( \frac{\beta}{4} \right) \text{ for } n \text{ even}$$

Assuming the first element is a capacitor, we can scale the filter capacitor prototype values up to our desired cutoff frequency  $f_c$ :

$$C_k = \frac{g_k}{2\pi \cdot f_c \cdot R_{IN}}, \quad k = 1, 3, \dots, n$$

The filter inductor values can be scaled with:

$$L_k = \frac{g_k \cdot R_{IN}}{2\pi \cdot f_c}, \quad k = 2, 4, \dots, n$$

where  $R_{IN}$  is the input impedance and the terminating impedance  $R_{OUT}$  is equal to  $R_{IN}$  for the  $n$  odd case but is scaled by the  $g_{n+1}$  prototype value for the  $n$  even case.

The Impedance Bisection Theorem can be applied to symmetrical networks by dividing the element values along the networks' plane of symmetry, and then adding the two networks together. The filter response is preserved.

For example, if  $L_{Ar}|_{dB} = 0.2\text{dB}$ ,  $f_c = 40\text{MHz}$ ,  $R_{IN} = 100\Omega$ ,  $R_{OUT} = 20\Omega$  and  $n = 5$ , the prototype element values and resulting scaled filter values are listed:

**Filter 1:**  $R_{IN} = R_{OUT} = 100\Omega$

$$g_1 = 1.339 \rightarrow C1 = 53.3\text{pF}$$

$$g_2 = 1.337 \rightarrow L1 = 531.98\text{nH}$$

$$g_3 = 2.166 \rightarrow C2 = 86.19\text{pF}$$

$$g_4 = 1.337 \rightarrow L2 = 531.98\text{nH}$$

$$g_5 = 1.339 \rightarrow C3 = 53.3\text{pF}$$

**Filter 2:**  $R_{IN} = R_{OUT} = 20\Omega$

$$g_1 = 1.339 \rightarrow C1 = 266.48\text{pF}$$

$$g_2 = 1.337 \rightarrow L1 = 106.4\text{nH}$$

$$g_3 = 2.166 \rightarrow C2 = 430.93\text{pF}$$

$$g_4 = 1.337 \rightarrow L2 = 106.4\text{nH}$$

$$g_5 = 1.339 \rightarrow C3 = 266.48\text{pF}$$

The Impedance Bisection Theorem can be applied at the plane of symmetry about  $C2$  such that a new value of  $C2$  can be computed with half the values of the two filters.

$$C2 \rightarrow \frac{86.19\text{pF}}{2} + \frac{430.93\text{pF}}{2} = 258.56\text{pF}$$

The final unequally-terminated filter design values are shown in Figure 37.

[1] A.C. Bartlett, "An Extension of a Property of Artificial Lines," Phil. Mag., vol.4, p.902, November 1927.

[2] G. Matthaei, L. Young, and E.M.T. Jones, Microwave Filters, Impedance-Matching Networks, and Coupling Structures, p.99, 1964.

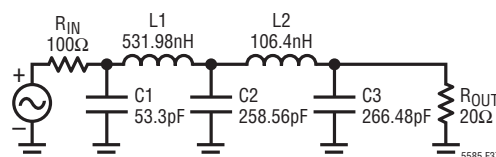

Figure 37. Final Design Schematic



## APPENDIX

### Image Rejection Calculation

Image rejection can be calculated from the measured gain and phase error responses of the demodulator. Consider the signal diagram of Figure 38:

where:

$$RF(t) = \sin(\omega_{LO} + \omega_{BB})t + \sin(\omega_{LO} - \omega_{IM})t$$

$$LO_I(t) = \cos(\omega_{LO}t + \phi_{ERR})$$

$$LO_Q(t) = \sin(\omega_{LO}t)$$

$\omega_{LO} + \omega_{BB}$  is the desired sideband frequency and  $\omega_{LO} - \omega_{IM}$  is the image frequency. The total phase error of the I and Q channels is lumped into the I-channel LO source as  $\phi_{ERR}$ . The total gain error is represented by  $A_{ERR}$ , and is lumped into a gain multiplier in the I-channel.

After lowpass filtering the I and Q signals can be written as:

$$I(t) = \frac{A_{ERR}}{2} [\sin(\omega_{BB}t - \phi_{ERR}) - \sin(\omega_{IM}t + \phi_{ERR})]$$

$$Q(t) = \frac{1}{2} [\cos(\omega_{BB}t) + \cos(\omega_{IM}t)]$$

Shifting the Q channel by  $-90^\circ$  can be accomplished by replacing sine with cosine such that the shifted Q-channel signal is:

$$Q_{-90}(t) = \frac{1}{2} [\sin(\omega_{BB}t) + \sin(\omega_{IM}t)]$$

We combine  $I(t) + Q_{-90}(t)$  and choose terms containing  $\omega_{BB}$  as the desired signal:

$$\text{desired} = \frac{1}{2} \sin(\omega_{BB}t) + \frac{A_{ERR}}{2} \sin(\omega_{BB}t - \phi_{ERR})$$

Similarly, we choose terms containing  $\omega_{IM}$  as the image signal:

$$\text{image} = \frac{1}{2} \sin(\omega_{IM}t) - \frac{A_{ERR}}{2} \sin(\omega_{IM}t + \phi_{ERR})$$

The image rejection ratio (IRR) can then be written as:

$$IRR|_{dB} = 10 \log \frac{|\text{desired}|^2}{|\text{image}|^2}$$

Written in terms of  $A_{ERR}$  and  $\phi_{ERR}$  as:

$$IRR|_{dB} = 10 \log \frac{|1 + A_{ERR}^2 + 2A_{ERR} \cos(\phi_{ERR})|}{|1 + A_{ERR}^2 - 2A_{ERR} \cos(\phi_{ERR})|}$$

Figure 39 shows image rejection as a function of amplitude and phase errors for a demodulator.

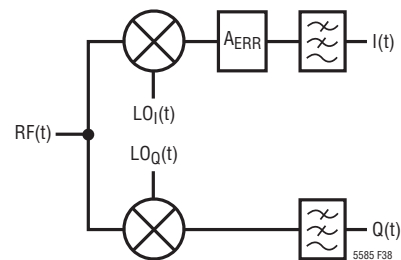

Figure 38. Signal Diagram for a Demodulator

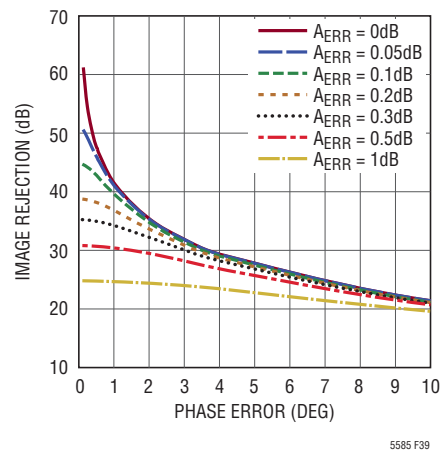

Figure 39. Image Rejection as a Function of Gain and Phase Errors

