

FEATURES

- Frequency Range: 700MHz to 6GHz
- Low Power: 2.7V to 3.6V Supply; 29.5mA
- Low LO Carrier Leakage: -43dBm at 1.8GHz
- Side-Band Suppression: -50dBc at 1.8GHz
- Output IP3: 19dBm at 1.8GHz
- Low RF Output Noise Floor: -157dBm/Hz at 30MHz Offset, $P_{RF} = 1.8\text{dBm}$, $f_{RF} = 2.17\text{GHz}$
- Sine Wave or Square Wave LO Drive
- SPI Control:
 - Adjustable Gain: 19dB in 1dB Steps
 - Effecting Supply Current from 9mA to 39mA
 - I/Q Offset Adjust: -64dBm LO Carrier Leakage
 - I/Q Gain/Phase Adjust: -61dBc Side-Band Suppressed
- 24-Lead 4mm × 4mm Plastic QFN Package

APPLICATIONS

- Wireless Microphones
- Battery Powered Radios
- Vector Modulator
- 2.45GHz and 5.8GHz Transmitters
- Software Defined Radios (SDR)
- Military Radios

DESCRIPTION

The **LTC®5589** is a direct conversion I/Q modulator designed for low power wireless applications that enables direct modulation of differential baseband I and Q signals on an RF carrier. Single side-band modulation or side-band suppressed upconversion can be achieved by applying 90° phase-shifted signals to the I and Q inputs. The I/Q baseband input ports can be either AC or DC coupled to a source with a common mode voltage level of about 1.4V. The SPI interface controls the supply current, modulator gain, and allows adjustments of I and Q gain and phase imbalance to optimize the LO carrier feedthrough and side-band suppression. The LO port can be driven with sine wave or square wave LO drive. A fixed LC network on the LO and RF ports covers 700MHz to 6GHz operating range. An on-chip thermometer can be activated to compensate for gain-temperature variations. More accurate temperature measurements can be made using an on-chip diode. In addition, a continuous analog gain control (V_{CTRL}) pin can be used for fast power control.

LT, LTC, LTM, Linear Technology, and the Linear logo are registered trademarks and QuikEval is a trademark of Linear Technology Corporation. All other trademarks are the property of their respective owners.

TYPICAL APPLICATION

700MHz to 6GHz Direct Conversion Transmitter Application

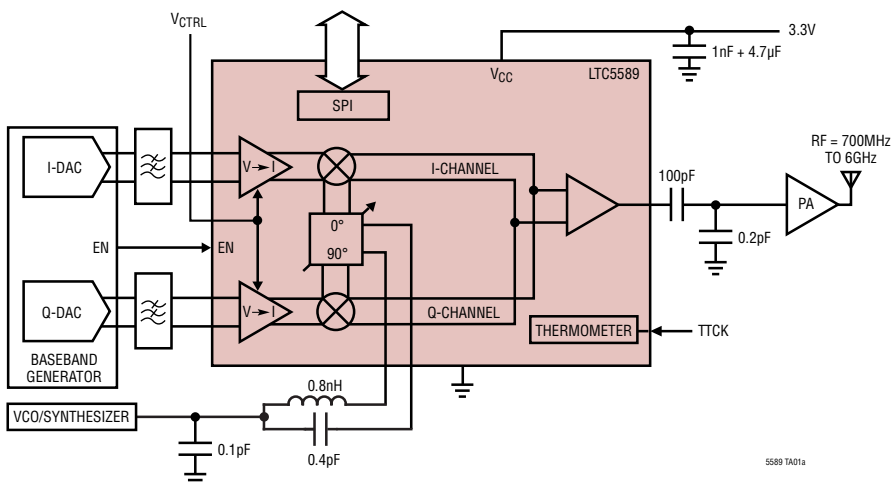

EVM and Noise Floor vs RF Output Power and Digital Gain Setting with 1Ms/s 16-QAM Signal

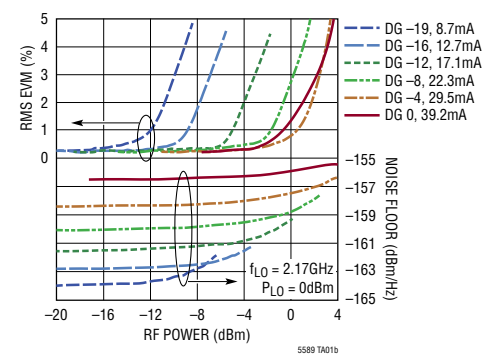

ABSOLUTE MAXIMUM RATINGS

(Note 1)

| | |
|--|--------------------------|
| Supply Voltage | 3.8V |
| Common Mode Voltage of BBPI, BBMI, and BBPQ, BBMQ | 2V |
| LOL, LOC DC Voltage | ±50mV |
| LOL, LOC Input Power (Note 15) | 20dBm |
| Output Current TEMP, SDO | 10mA |
| Voltage on Any Pin (Note 16) | -0.3V to $V_{CC} + 0.3V$ |
| T_{JMAX} | 150°C |
| Case Operating Temperature Range | -40°C to 105°C |
| Storage Temperature Range | -65°C to 150°C |

PIN CONFIGURATION

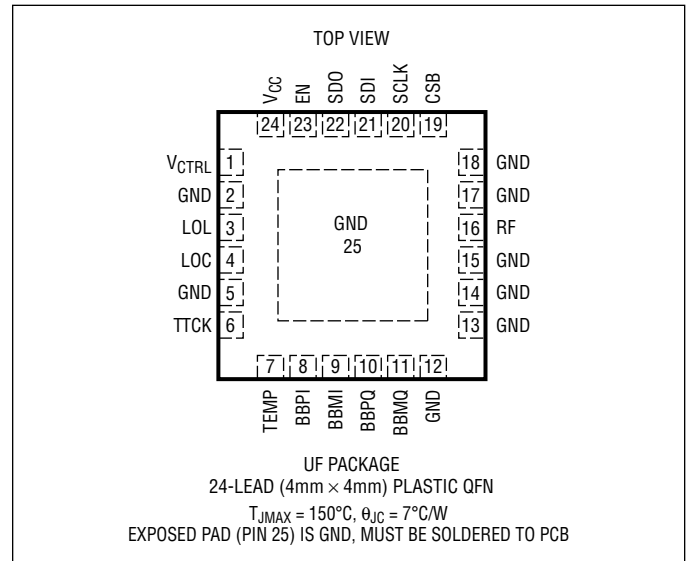

ORDER INFORMATION

(<http://www.linear.com/product/LTC5589#orderinfo>)

| LEAD FREE FINISH | TAPE AND REEL | PART MARKING | PACKAGE DESCRIPTION | CASE TEMPERATURE RANGE |
|------------------|------------------|--------------|---------------------------------|------------------------|
| LTC5589IUF#PBF | LTC5589IUF#TRPBF | 5589 | 24-Lead (4mm × 4mm) Plastic QFN | -40°C to 105°C |

Consult LTC Marketing for parts specified with wider operating temperature ranges..

For more information on lead free part marking, go to: <http://www.linear.com/leadfree/>

For more information on tape and reel specifications, go to: <http://www.linear.com/tapeandreeel/>. Some packages are available in 500 unit reels through designated sales channels with #TRMPBF suffix.

Please refer to: <http://www.linear.com/designtools/packaging/> for the most recent package drawings.

ELECTRICAL CHARACTERISTICS

The ● denotes the specifications which apply over the full operating temperature range, otherwise specifications are at $T_C = 25^\circ\text{C}$. $V_{CC} = 3.3V$, $EN = 3.3V$, $V_{CTRL} = 3.3V$, $P_{LO} = 0\text{dBm}$, BBPI, BBMI, BBPQ, BBMQ common mode DC voltage $V_{CMBB} = 1.4V_{DC}$, I and Q baseband input signal = 2MHz, 2.1MHz, $1V_{P-P(DIFF)}$ (I or Q), I and Q 90° shifted, lower sideband selection, all registers set to default values, unless otherwise noted. Test circuit is shown in Figure 12.

| SYMBOL | PARAMETER | CONDITIONS | MIN | TYP | MAX | UNITS |
|--|----------------------------|---|-----|--------------|-----|--------|
| $f_{LO} = 800\text{MHz}$, $f_{RF1} = 797.9\text{MHz}$, $f_{RF2} = 798\text{MHz}$, Register 0x00 = 0x70 (Decimal 112), L1 = 4.7nH, C5 = 2pF, C18 = 0.2pF | | | | | | |
| $S_{22(ON)}$ | RF Port Return Loss | | | -24 | | dB |
| $f_{LO(MATCH)}$ | LO Match Frequency Range | $S_{11} < -10\text{dB}$ | | 0.74 to 1.97 | | GHz |
| Gain | Conversion Voltage Gain | $20 \cdot \text{Log} (V_{RF(OUT)(50\Omega)} / V_{IN(DIFF)}(I \text{ or } Q))$ | | -10.5 | | dB |
| P_{OUT} | Absolute Output Power | $1V_{P-P(DIFF)}$ CW Signal, I and Q | | -6.5 | | dBm |
| OP1dB | Output 1dB Compression | | | 4.1 | | dBm |
| OIP2 | Output 2nd Order Intercept | (Note 5) | | 70.6 | | dBm |
| OIP3 | Output 3rd Order Intercept | (Note 6) | | 19.9 | | dBm |
| NFloor | RF Output Noise Floor | No Baseband AC Input Signal (Note 3) | | -159.6 | | dBm/Hz |
| SB | Side-Band Suppression | (Note 7) | | -48 | | dBc |

ELECTRICAL CHARACTERISTICS The ● denotes the specifications which apply over the full operating temperature range, otherwise specifications are at $T_C = 25^\circ\text{C}$. $V_{CC} = 3.3\text{V}$, $EN = 3.3\text{V}$, $V_{CTRL} = 3.3\text{V}$, $P_{LO} = 0\text{dBm}$, BBPI, BBMI, BBPQ, BBMQ common mode DC voltage $V_{CMBB} = 1.4V_{DC}$, I and Q baseband input signal = 2MHz, 2.1MHz, $1V_{P-P(DIFF, I \text{ or } Q)}$, I and Q 90° shifted, lower sideband selection, all registers set to default values, unless otherwise noted. Test circuit is shown in Figure 12.

| SYMBOL | PARAMETER | CONDITIONS | MIN | TYP | MAX | UNITS |
|---------------------|----------------------------------|---|-----|------------|-----|------------|
| LOFT | Carrier Leakage (LO Feedthrough) | (Note 7) EN = Low (Note 7) | | -46 -71 | | dBm dBm |
| 2LOFT | LO Feedthrough at 2xLO | | | -62.5 | | dBm |
| 2LO | Signal Powers at 2xLO | Maximum of $2f_{LO} - 2f_{BB}$; $2f_{LO} - f_{BB}$; $2f_{LO} + f_{BB}$, $2f_{LO} + 2f_{BB}$ | | -49.1 | | dBc |
| 3LOFT | LO Feedthrough at 3xLO | | | -57.9 | | dBm |
| 3LO | Signal Powers at 3xLO | Maximum of $3f_{LO} - f_{BB}$; $3f_{LO} + f_{BB}$ | | -10.6 | | dBc |
| BW1dB _{BB} | -1dB Baseband Bandwidth | $R_{SOURCE} = 50\Omega$, Differential | | 43 | | MHz |
| BW3dB _{BB} | -3dB Baseband Bandwidth | $R_{SOURCE} = 50\Omega$, Differential | | 91 | | MHz |

$f_{LO} = 1800\text{MHz}$, $f_{RF1} = 1797.9\text{MHz}$, $f_{RF2} = 1798\text{MHz}$, Register 0x00 = 0x4B (Decimal 75), L1 = 4.7nH, C5 = 2pF, C18 = 0.2pF

| | | | | | | |
|---------------------|----------------------------------|---|--|-------------|--|------------|
| S _{22(ON)} | RF Port Return Loss | | | -21 | | dB |
| $f_{LO(MATCH)}$ | LO Match Frequency Range | $S_{11} < -10\text{dB}$ | | 0.84 to 5.8 | | GHz |
| Gain | Conversion Voltage Gain | $20 \cdot \text{Log}(V_{RF(OUT)(50\Omega)}/V_{IN(DIFF)(I \text{ or } Q)})$ | | -9.7 | | dB |
| P _{OUT} | Absolute Output Power | $1V_{P-P(DIFF)}$ CW Signal, I and Q | | -5.7 | | dBm |
| OP1dB | Output 1dB Compression | | | 4.6 | | dBm |
| OIP2 | Output 2nd Order Intercept | (Note 5) | | 60.4 | | dBm |
| OIP3 | Output 3rd Order Intercept | (Note 6) | | 19 | | dBm |
| NFloor | RF Output Noise Floor | No Baseband AC Input Signal (Note 3) | | -158.8 | | dBm/Hz |
| SB | Side-Band Suppression | (Note 7) | | -50 | | dBc |
| LOFT | Carrier Leakage (LO Feedthrough) | (Note 7) EN = Low (Note 7) | | -43 -52 | | dBm dBm |
| 2LOFT | LO Feedthrough at 2xLO | | | -61.3 | | dBm |
| 2LO | Signal Powers at 2xLO | Maximum of $2f_{LO} - 2f_{BB}$; $2f_{LO} - f_{BB}$; $2f_{LO} + f_{BB}$, $2f_{LO} + 2f_{BB}$ | | -47 | | dBc |
| 3LOFT | LO Feedthrough at 3xLO | | | -73.8 | | dBm |
| 3LO | Signal Powers at 3xLO | Maximum of $3f_{LO} - f_{BB}$; $3f_{LO} + f_{BB}$ | | -18.6 | | dBc |
| | Gain from LO to RF | BBPI = BBPQ = 1.9V | | 10 | | dB |
| | LO Input Noise Figure | BBMI = BBMQ = 0.9V | | 12.5 | | dB |
| | LO Input 3rd Order Intercept | (Vector Modulator) | | -2 | | dBm |
| BW1dB _{BB} | -1dB Baseband Bandwidth | $R_{SOURCE} = 50\Omega$, Differential | | 92 | | MHz |
| BW3dB _{BB} | -3dB Baseband Bandwidth | $R_{SOURCE} = 50\Omega$, Differential | | 168 | | MHz |

$f_{LO} = 2500\text{MHz}$, $f_{RF1} = 2497.9\text{MHz}$, $f_{RF2} = 2498\text{MHz}$, Register 0x00 = 0x3F (Decimal 63), L1 = 4.7nH, C5 = 2pF, C18 = 0.2pF

| | | | | | | |
|---------------------|----------------------------|--|--|-----------|--|-----|
| S _{22(ON)} | RF Port Return Loss | | | -21 | | dB |
| $f_{LO(MATCH)}$ | LO Match Frequency Range | $S_{11} < -10\text{dB}$ | | 0.86 to 6 | | GHz |
| Gain | Conversion Voltage Gain | $20 \cdot \text{Log}(V_{RF(OUT)(50\Omega)}/V_{IN(DIFF)(I \text{ or } Q)})$ | | -10.2 | | dB |
| P _{OUT} | Absolute Output Power | $1V_{P-P(DIFF)}$ CW Signal, I and Q | | -6.2 | | dBm |
| OP1dB | Output 1dB Compression | | | 3.9 | | dBm |
| OIP2 | Output 2nd Order Intercept | (Note 5) | | 62 | | dBm |
| OIP3 | Output 3rd Order Intercept | (Note 6) | | 17.5 | | dBm |

ELECTRICAL CHARACTERISTICS The ● denotes the specifications which apply over the full operating temperature range, otherwise specifications are at $T_C = 25^\circ\text{C}$. $V_{CC} = 3.3\text{V}$, $EN = 3.3\text{V}$, $V_{CTRL} = 3.3\text{V}$, $P_{LO} = 0\text{dBm}$, BBPI, BBMI, BBPQ, BBMQ common mode DC voltage $V_{CMBB} = 1.4V_{DC}$, I and Q baseband input signal = 2MHz, 2.1MHz, $1V_{P-P(DIFF)}$ (I or Q), I and Q 90° shifted, lower sideband selection, all registers set to default values, unless otherwise noted. Test circuit is shown in Figure 12.

| SYMBOL | PARAMETER | CONDITIONS | MIN | TYP | MAX | UNITS |
|---|----------------------------------|---|-----|----------------|-----|------------------|
| NFloor | RF Output Noise Floor | No Baseband AC Input Signal (Note 3) $P_{OUT} = 1.8\text{dBm}$ (Note 17) | | -158.1 -157 | | dBm/Hz dBm/Hz |
| SB | Side-Band Suppression | (Note 7) | | -41.5 | | dBc |
| LOFT | Carrier Leakage (LO Feedthrough) | (Note 7) $EN = \text{Low}$ (Note 7) | | -40.2 -50 | | dBm dBm |
| 2LOFT | LO Feedthrough at 2xLO | | | -65.4 | | dBm |
| 2LO | Signal Powers at 2xLO | Maximum of $2f_{LO} - 2f_{BB}$; $2f_{LO} - f_{BB}$; $2f_{LO} + f_{BB}$, $2f_{LO} + 2f_{BB}$ | | -48.8 | | dBc |
| 3LOFT | LO Feedthrough at 3xLO | | | -77.2 | | dBm |
| 3LO | Signal Powers at 3xLO | Maximum of $3f_{LO} - f_{BB}$; $3f_{LO} + f_{BB}$ | | -25.9 | | dBc |
| BW1dB _{BB} | -1dB Baseband Bandwidth | $R_{SOURCE} = 50\Omega$, Differential | | 65 | | MHz |
| BW3dB _{BB} | -3dB Baseband Bandwidth | $R_{SOURCE} = 50\Omega$, Differential | | 167 | | MHz |
| $f_{LO} = 3500\text{MHz}$, $f_{RF1} = 3497.9\text{MHz}$, $f_{RF2} = 3498\text{MHz}$, Register 0x00 = 0x2F (Decimal 47), L1 = 0.8nH, C5 = 0.4pF, C18 = 0.1pF (5.8GHz LO Match) | | | | | | |
| S _{22(ON)} | RF Port Return Loss | | | -25 | | dB |
| $f_{LO(MATCH)}$ | LO Match Frequency Range | $S_{11} < -10\text{dB}$ | | 1.2 to 6 | | GHz |
| Gain | Conversion Voltage Gain | $20 \cdot \text{Log}(V_{RF(OUT)(50\Omega)} / V_{IN(DIFF)}(I \text{ or } Q))$ | | -12.7 | | dB |
| P_{OUT} | Absolute Output Power | $1V_{P-P(DIFF)}$ CW Signal, I and Q | | -8.7 | | dBm |
| OP1dB | Output 1dB Compression | (Note 18) | | 1.1 | | dBm |
| OIP2 | Output 2nd Order Intercept | (Note 5) | | 41.8 | | dBm |
| OIP3 | Output 3rd Order Intercept | (Note 6) | | 14.6 | | dBm |
| NFloor | RF Output Noise Floor | No Baseband AC Input Signal (Note 3) | | -159.6 | | dBm/Hz |
| SB | Side-Band Suppression | (Note 7) | | -43 | | dBc |
| LOFT | Carrier Leakage (LO Feedthrough) | (Note 7) $EN = \text{Low}$ (Note 7) | | -34.5 -39.8 | | dBm dBm |
| 2LOFT | LO Feedthrough at 2xLO | | | -66.5 | | dBm |
| 2LO | Signal Powers at 2xLO | Maximum of $2f_{LO} - 2f_{BB}$; $2f_{LO} - f_{BB}$; $2f_{LO} + f_{BB}$, $2f_{LO} + 2f_{BB}$ | | -46.3 | | dBc |
| 3LOFT | LO Feedthrough at 3xLO | | | -71.4 | | dBm |
| 3LO | Signal Powers at 3xLO | Maximum of $3f_{LO} - f_{BB}$; $3f_{LO} + f_{BB}$ | | -31.7 | | dBc |
| BW1dB _{BB} | -1dB Baseband Bandwidth | $R_{SOURCE} = 50\Omega$, Differential | | 76 | | MHz |
| BW3dB _{BB} | -3dB Baseband Bandwidth | $R_{SOURCE} = 50\Omega$, Differential | | 173 | | MHz |
| $f_{LO} = 4500\text{MHz}$, $f_{RF1} = 4497.9\text{MHz}$, $f_{RF2} = 4498\text{MHz}$, Register 0x00 = 0x24 (Decimal 36), L1 = 0.8nH, C5 = 0.4pF, C18 = 0.1pF (5.8GHz LO Match) | | | | | | |
| S _{22(ON)} | RF Port Return Loss | | | -20 | | dB |
| $f_{LO(MATCH)}$ | LO Match Frequency Range | $S_{11} < -10\text{dB}$ | | 1.3 to 6 | | GHz |
| Gain | Conversion Voltage Gain | $20 \cdot \text{Log}(V_{RF(OUT)(50\Omega)} / V_{IN(DIFF)}(I \text{ or } Q))$ | | -16.3 | | dB |
| P_{OUT} | Absolute Output Power | $1V_{P-P(DIFF)}$ CW Signal, I and Q | | -12.3 | | dBm |
| OP1dB | Output 1dB Compression | (Note 18) | | -2.2 | | dBm |
| OIP2 | Output 2nd Order Intercept | (Note 5) | | 35.2 | | dBm |
| OIP3 | Output 3rd Order Intercept | (Note 6) | | 11.2 | | dBm |
| NFloor | RF Output Noise Floor | No Baseband AC Input Signal (Note 3) | | -161.3 | | dBm/Hz |

ELECTRICAL CHARACTERISTICS The ● denotes the specifications which apply over the full operating temperature range, otherwise specifications are at $T_C = 25^\circ\text{C}$. $V_{CC} = 3.3\text{V}$, $EN = 3.3\text{V}$, $V_{CTRL} = 3.3\text{V}$, $P_{LO} = 0\text{dBm}$, BBPI, BBMI, BBPQ, BBMQ common mode DC voltage $V_{CMBB} = 1.4V_{DC}$, I and Q baseband input signal = 2MHz, 2.1MHz, $1V_{P-P(DIFF, I \text{ or } Q)}$, I and Q 90° shifted, lower sideband selection, all registers set to default values, unless otherwise noted. Test circuit is shown in Figure 12.

| SYMBOL | PARAMETER | CONDITIONS | MIN | TYP | MAX | UNITS |
|---------------------|----------------------------------|---|-----|------------|-----|------------|
| SB | Side-Band Suppression | (Note 7) | | -44 | | dBc |
| LOFT | Carrier Leakage (LO Feedthrough) | (Note 7) EN = Low (Note 7) | | -33 -34 | | dBm dBm |
| 2LOFT | LO Feedthrough at 2xLO | | | -67 | | dBm |
| 2LO | Signal Powers at 2xLO | Maximum of $2f_{LO} - 2f_{BB}$; $2f_{LO} - f_{BB}$; $2f_{LO} + f_{BB}$, $2f_{LO} + 2f_{BB}$ | | -45 | | dBc |
| 3LOFT | LO Feedthrough at 3xLO | | | -73 | | dBm |
| 3LO | Signal Powers at 3xLO | Maximum of $3f_{LO} - f_{BB}$; $3f_{LO} + f_{BB}$ | | -42 | | dBc |
| BW1dB _{BB} | -1dB Baseband Bandwidth | $R_{SOURCE} = 50\Omega$, Differential | | 98 | | MHz |
| BW3dB _{BB} | -3dB Baseband Bandwidth | $R_{SOURCE} = 50\Omega$, Differential | | 176 | | MHz |

$f_{LO} = 5800\text{MHz}$, $f_{RF1} = 5797.9\text{MHz}$, $f_{RF2} = 5798\text{MHz}$, Register 0x00 = 0x1A (Decimal 26), L1 = 0.8nH, C5 = 0.4pF, C18 = 0.1pF (5.8GHz LO Match)

| | | | | | | |
|---------------------|----------------------------------|---|--|----------------|--|------------|
| $S_{22(ON)}$ | RF Port Return Loss | | | -14.8 | | dB |
| $f_{LO(MATCH)}$ | LO Match Frequency Range | $S_{11} < -10\text{dB}$ | | 1.3 to 6 | | GHz |
| Gain | Conversion Voltage Gain | $20 \cdot \text{Log} (V_{RF(OUT)(50\Omega)} / V_{IN(DIFF)(I \text{ or } Q)})$ | | -21 | | dB |
| P_{OUT} | Absolute Output Power | $1V_{P-P(DIFF)}$ CW Signal, I and Q | | -17 | | dBm |
| OP1dB | Output 1dB Compression | (Note 18) | | -7.1 | | dBm |
| OIP2 | Output 2nd Order Intercept | (Note 5) | | 28.3 | | dBm |
| OIP3 | Output 3rd Order Intercept | (Note 6) | | 7 | | dBm |
| NFloor | RF Output Noise Floor | No Baseband AC Input Signal (Note 3) | | -162.7 | | dBm/Hz |
| SB | Side-Band Suppression | (Note 7) | | -31 | | dBc |
| LOFT | Carrier Leakage (LO Feedthrough) | (Note 7) EN = Low (Note 7) | | -37.6 -29.9 | | dBm dBm |
| 2LOFT | LO Feedthrough at 2xLO | | | -72.5 | | dBm |
| 2LO | Signal Powers at 2xLO | Maximum of $2f_{LO} - 2f_{BB}$; $2f_{LO} - f_{BB}$; $2f_{LO} + f_{BB}$, $2f_{LO} + 2f_{BB}$ | | -46.9 | | dBc |
| 3LOFT | LO Feedthrough at 3xLO | | | -78.6 | | dBm |
| 3LO | Signal Powers at 3xLO | Maximum of $3f_{LO} - f_{BB}$; $3f_{LO} + f_{BB}$ | | -53.3 | | dBc |
| BW1dB _{BB} | -1dB Baseband Bandwidth | $R_{SOURCE} = 50\Omega$, Differential | | 100 | | MHz |
| BW3dB _{BB} | -3dB Baseband Bandwidth | $R_{SOURCE} = 50\Omega$, Differential | | 181 | | MHz |

Analog Variable Gain Control (V_{CTRL})

| | | | | | | |
|---------------|------------------------------|--|--|------------|--|----------|
| V_{CTRLR} | Gain Control Voltage Range | Set Bit 6 in Register 0x01 | | 0.9 to 3.3 | | V |
| G_{CTRL} | Gain Control Gain Range | Set Bit 6 in Register 0x01 | | -73 to -10 | | dB |
| τ_{CTRL} | Gain Control Response Time | Set Bit 6 in Register 0x01 (Note 8) | | 20 | | ns |
| Z_{CTRL} | Gain Control Input Impedance | Set Bit 6 in Register 0x01 | | 10 | | pF |
| I_{CTRL} | DC Input Current | Set Bit 6 in Register 0x01 Clear Bit 6 in Register 0x01 | | 2.55 0 | | mA mA |

ELECTRICAL CHARACTERISTICS The ● denotes the specifications which apply over the full operating temperature range, otherwise specifications are at $T_C = 25^\circ\text{C}$. $V_{CC} = 3.3\text{V}$, $EN = 3.3\text{V}$, $V_{CTRL} = 3.3\text{V}$, $P_{LO} = 0\text{dBm}$, BBPI, BBMI, BBPQ, BBMQ common mode DC voltage $V_{CMBB} = 1.4V_{DC}$, I and Q baseband input signal = 2MHz, 2.1MHz, $1V_{P-P(DIFF, I \text{ or } Q)}$, I and Q 90° shifted, lower sideband selection, all registers set to default values, unless otherwise noted. Test circuit is shown in Figure 12.

| SYMBOL | PARAMETER | CONDITIONS | MIN | TYP | MAX | UNITS |
|--|--------------------------------|---|---------------------|------|-----|----------------------|
| Baseband Inputs (BBPI, BBMI, BBPQ, BBMQ) | | | | | | |
| V_{CMBB} | DC Common Mode Voltage | Internally Generated | | 1.41 | | V |
| $R_{IN(DIFF)}$ | Input Resistance | Differential | | 1.8 | | k Ω |
| $R_{IN(CM)}$ | Common Mode Input Resistance | Four Baseband Pins Shorted | | 350 | | Ω |
| $I_{BB(OFF)}$ | Baseband Leakage Current | Four Baseband Pins Shorted, EN = Low | | 1.3 | | nA |
| V_{SWING} | Amplitude Swing | No Hard Clipping, Single-Ended, Digital Gain (DG) = -10 | | 1.2 | | V_{P-P} |
| Power Supply (V_{CC}) | | | | | | |
| V_{CC} | Supply Voltage Range | | ● 2.7 | | 3.6 | V |
| $V_{RET(MIN)}$ | Minimum Data Retention Voltage | (Note 14) | ● 1.8 | 1.5 | | V |
| $I_{CC(ON)}$ | Supply Current | EN = High | 20 | 29.5 | 37 | mA |
| $I_{CC(RANGE)}$ | Supply Current Range | EN = High, Register 0x01 = 0x00 | | 39 | | mA |
| | | EN = High, Register 0x01 = 0x13 | | 9 | | mA |
| $I_{CC(OFF)}$ | Supply Current, Sleep Mode | EN = 0V | | 0.6 | 9 | μA |
| t_{ON} | Turn-On Time | EN = Low to High (Notes 8, 12) | | 30 | | ns |
| t_{OFF} | Turn-Off Time | EN = High to Low (Notes 9, 12) | | 33 | | ns |
| t_{SB} | Side-Band Suppression Settling | Register 0x00 Change, <-50dBc (Notes 12, 18) | | 350 | | ns |
| t_{LO} | LO Suppression Settling | Register 0x02 Change, <-60dBm (Note 12) | | 125 | | ns |
| Serial Port (CSB, SCLK, SDI, SDO), Enable (EN) and TTCK, SCLK = 20MHz | | | | | | |
| V_{IH} | Input High Voltage | | ● 1.1 | | | V |
| V_{IL} | Input Low Voltage | | ● | | 0.2 | V |
| I_{IH} | Input High Current | | | 0.02 | | nA |
| I_{IL} | Input Low Current | | | -0.4 | | nA |
| V_{OH} | Output High Voltage | (Note 13) | ● $V_{CC_L} - 0.2$ | | | V |
| V_{OL} | Output Low Voltage | $I_{SINK} = 8\text{mA}$ (Note 10) | ● | | 0.7 | V |
| I_{OH} | SDO Leakage Current | for SDO = High | | 0.5 | | nA |
| V_{HYS} | Input Trip Point Hysteresis | | | 110 | | mV |
| t_{CKH} | SCLK High Time | | ● 22.5 | | | ns |
| t_{CSS} | CSB Setup Time | | ● 20 | | | ns |
| t_{CSH} | CSB High Time | | ● 30 | | | ns |
| t_{CS} | SDI to SCLK Setup Time | | ● 20 | | | ns |
| t_{CH} | SDI to SCLK Hold Time | | ● 10 | | | ns |
| t_{DO} | SCLK to SDO Time | | ● 45 | | | ns |
| $t_{C\%}$ | SCLK Duty Cycle | | ● 45 | 50 | 55 | % |
| f_{CLK} | Maximum SCLK Frequency | | ● 20 | | | MHz |
| V_{TEMP} | Temperature Diode Voltage | $I_{TEMP} = 100\mu\text{A}$ | | 772 | | mV |
| | Temperature Slope | $I_{TEMP} = 100\mu\text{A}$ | | -1.5 | | mV/ $^\circ\text{C}$ |

ELECTRICAL CHARACTERISTICS

Note 1: Stresses beyond those listed under Absolute Maximum Ratings may cause permanent damage to the device. Exposure to any Absolute Maximum Rating condition for extended periods may affect device reliability and lifetime.

Note 2: The LTC5589 is guaranteed functional over the operating case temperature range from -40°C to 105°C .

Note 3: At 6MHz offset from the LO signal frequency. 100nF between BBPI and BBMI, 100nF between BBPQ and BBMQ.

Note 4: The Default Register Settings are listed in Table 1.

Note 5: IM2 is measured at $f_{\text{LO}} - 4.1\text{MHz}$.

Note 6: IM3 is measured at $f_{\text{LO}} - 2.2\text{MHz}$ and $f_{\text{LO}} - 1.9\text{MHz}$. OIP3 = lowest of $(1.5 \cdot P(f_{\text{LO}} - 2.1\text{MHz}) - 0.5 \cdot P(f_{\text{LO}} - 2.2\text{MHz}))$ and $(1.5 \cdot P(f_{\text{LO}} - 2\text{MHz}) - 0.5 \cdot P(f_{\text{LO}} - 1.9\text{MHz}))$.

Note 7: Without side-band or LO feedthrough nulling (unadjusted).

Note 8: RF power is within 10% of final value.

Note 9: RF power is at least 30dB down from its ON state.

Note 10: V_{OL} voltage scales linear with current sink. For example for $R_{\text{PULL-UP}} = 1\text{k}\Omega$, $V_{\text{CC-L}} = 3.3\text{V}$ the SDO sink current is about $(3.3 - 0.2) / 1\text{k}\Omega = 3.1\text{mA}$. Max $V_{\text{OL}} = 0.7 \cdot 3.1 / 8 = 0.271\text{V}$, with $R_{\text{PULL-UP}}$ the SDO pull-up resistor and $V_{\text{CC-L}}$ the digital supply voltage to which $R_{\text{PULL-UP}}$ is connected to.

Note 11: I and Q baseband Input signal = 2MHz CW, $0.8\text{V}_{\text{P-P}}$, DIFF each, I and Q 0° shifted.

Note 12: $f_{\text{LO}} = 1800\text{MHz}$, $P_{\text{LO}} = 0\text{dBm}$, $C_4 = 10\text{pF}$

Note 13: Maximum V_{OH} is derated for capacitive load using the following formula: $V_{\text{CC-L}} \cdot \exp(-0.5 \cdot T_{\text{CLK}} / (R_{\text{PULL-UP}} \cdot C_{\text{LOAD}}))$, with T_{CLK} the time of one SCLK cycle, $R_{\text{PULL-UP}}$ the SDO pull-up resistor, $V_{\text{CC-L}}$ the digital supply voltage to which $R_{\text{PULL-UP}}$ is connected to, and C_{LOAD} the capacitive load at the SDO pin. For example for $T_{\text{CLK}} = 100\text{ns}$ (10MHz SCLK), $R_{\text{PULL-UP}} = 1\text{k}\Omega$, $C_{\text{LOAD}} = 10\text{pF}$ and $V_{\text{CC-L}} = 3.3\text{V}$ the derating is $3.3 \cdot \exp(-5) = 22.2\text{mV}$, thus maximum $V_{\text{OH}} = 3.3\text{V} - 0.1 - 0.0222 = 3.177\text{V}$.

Note 14: Minimum V_{CC} in order to retain register data content.

Note 15: Guaranteed by design and characterization. This parameter is not tested.

Note 16: RF pin guaranteed by design while using a 100pF coupling capacitor. The RF pin is not tested.

Note 17: $f_{\text{LO}} = 2.17\text{GHz}$, $f_{\text{NOISE}} = 2.14\text{GHz}$, $f_{\text{BB}} = 2\text{kHz}$. 100nF between BBPI and BBMI, 100nF between BBPQ and BBMQ.

Note 18: Using 2.14GHz bandpass filter with $\text{BW} = 5\text{MHz}$, $f_{\text{BB}} = 25\text{MHz}$, $f_{\text{LO}} = 2.115\text{GHz}$, measured from parallel load (see Figure 7).

TYPICAL PERFORMANCE CHARACTERISTICS

$V_{CC} = 3.3V$, $EN = 3.3V$, $V_{CTRL} = 3.3V$, $T_C = 25^\circ C$, $P_{LO} = 0dBm$, $f_{LO} = 1.8GHz$, BBPI, BBMI, BBPQ, BBMQ common mode DC voltage $V_{CMBB} = 1.4V_{DC}$, I and Q baseband input signal = 2MHz, 2.1MHz, 1V_{P-P}(DIFF, I or Q), I and Q 90° shifted, lower sideband selection, TEMPUPDT = 0, register 0x00 value according to Table 6, all other registers set to default values, unless otherwise noted. Test circuit is shown in Figure 12.

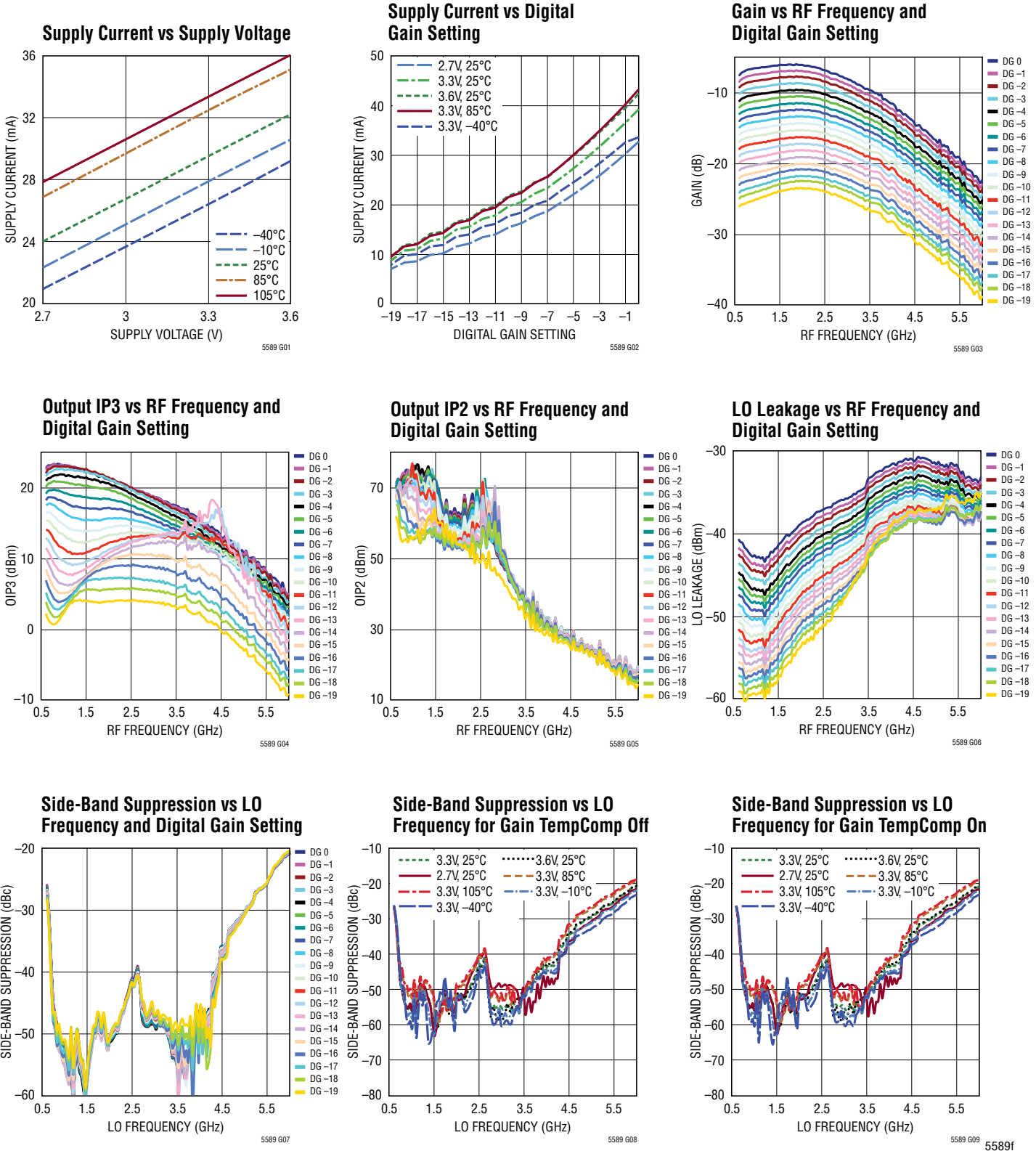

TYPICAL PERFORMANCE CHARACTERISTICS

$V_{CC} = 3.3V$, $V_{EN} = 3.3V$, $V_{CTRL} = 3.3V$, $T_C = 25^\circ C$, $P_{LO} = 0dBm$, $f_{LO} = 1.8GHz$, BBPI, BBMI, BBPQ, BBMQ common mode DC voltage $V_{CMBB} = 1.4V_{DC}$, I and Q baseband input signal = 2MHz, 2.1MHz, $1V_{P-P}(DIFF, I \text{ or } Q)$, I and Q 90° shifted, lower sideband selection, TEMPUPDT = 0, register 0x00 value according to Table 6, all other registers set to default values, unless otherwise noted. Test circuit is shown in Figure 12.

Noise Floor vs RF Frequency and Digital Gain Setting

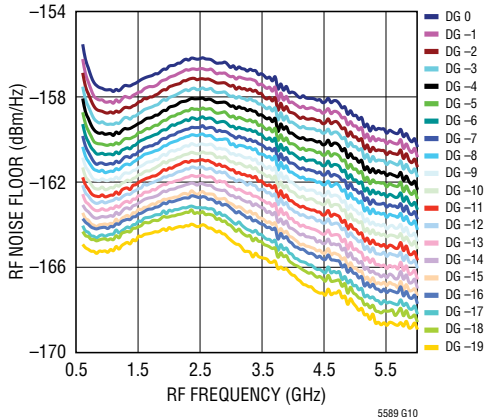

Output 1dB Compression Point vs RF Frequency and Digital Gain Setting and 2.7V Supply

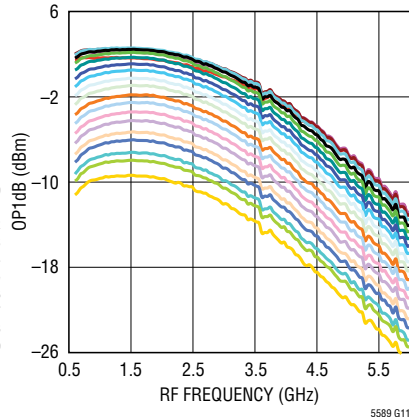

Output 1dB Compression Point vs RF Frequency and Digital Gain Setting and 3.3V Supply

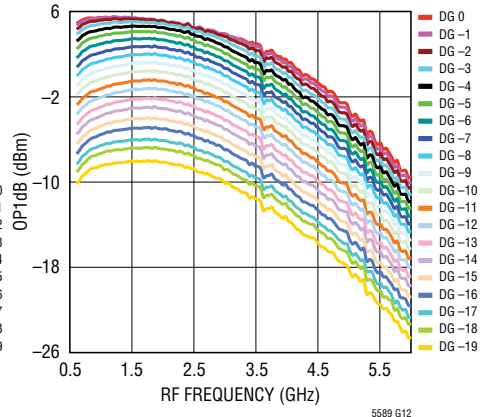

Output 1dB Compression Point vs RF Frequency and Digital Gain Setting and 3.6V Supply

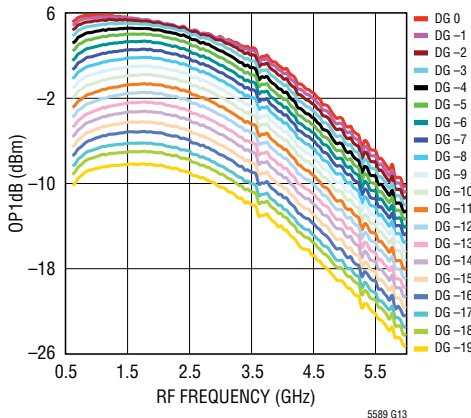

Output 1dB Compression Point vs RF Frequency and Digital Gain Setting at 2.7V Supply, -40°C

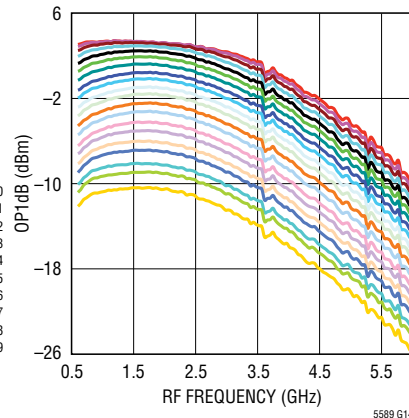

Output 1dB Compression Point vs RF Frequency and Digital Gain Setting at 3.3V Supply, -40°C

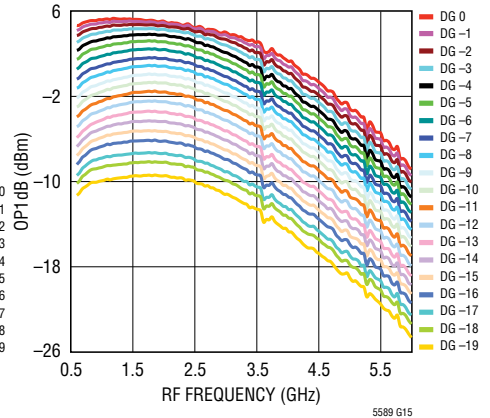

Output 1dB Compression Point vs RF Frequency and Digital Gain Setting at 2.7V Supply, -10°C

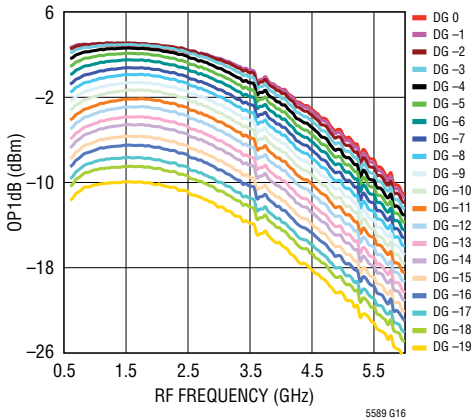

Output 1dB Compression Point vs RF Frequency and Digital Gain Setting at 3.3V Supply, -10°C

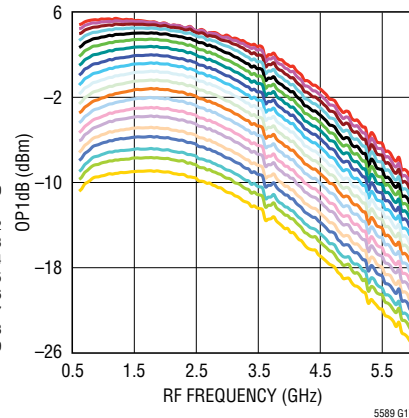

Output 1dB Compression Point vs RF Frequency and Digital Gain Setting at 2.7V Supply, 85°C

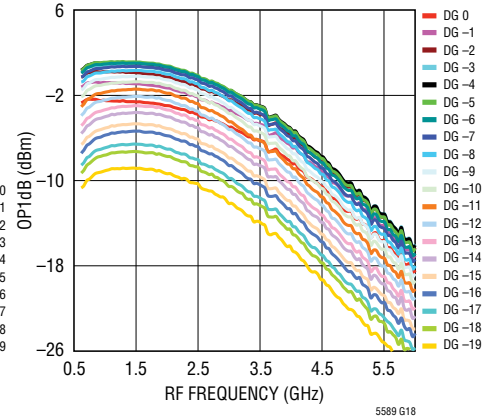

TYPICAL PERFORMANCE CHARACTERISTICS

$V_{CC} = 3.3V$, $EN = 3.3V$, $V_{CTRL} = 3.3V$, $T_C = 25^\circ C$, $P_{LO} = 0dBm$, $f_{LO} = 1.8GHz$, BBPI, BBMI, BBPQ, BBMQ common mode DC voltage $V_{CMBB} = 1.4V_{DC}$, I and Q baseband input signal = 2MHz, 2.1MHz, 1V_{P-P}(DIFF, I or Q), I and Q 90° shifted, lower sideband selection, TEMPUPDT = 0, register 0x00 value according to Table 6, all other registers set to default values, unless otherwise noted. Test circuit is shown in Figure 12.

Output 1dB Compression Point vs RF Frequency and Digital Gain Setting at 3.3V Supply, 85°C

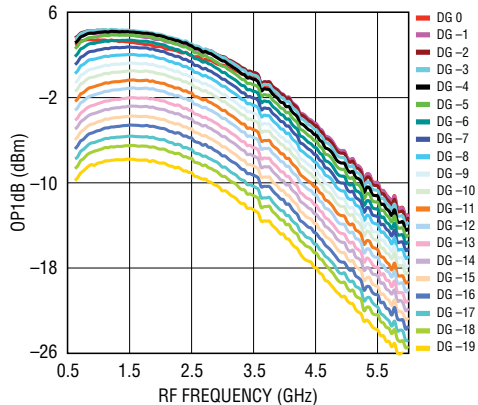

5589 G19

Output 1dB Compression Point vs RF Frequency and Digital Gain Setting at 2.7V Supply, 105°C

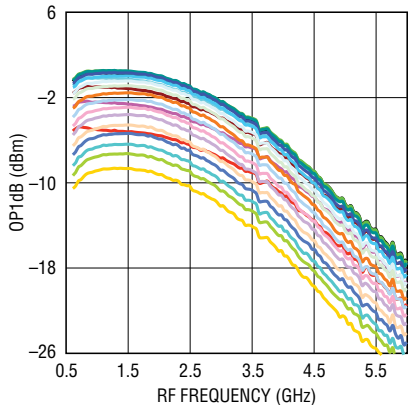

5589 G20

Output 1dB Compression Point vs RF Frequency and Digital Gain Setting at 3.3V Supply, 105°C

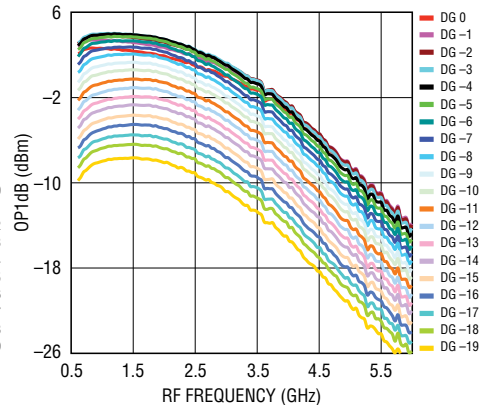

5589 G21

Gain vs RF Frequency and V_{CTRL}

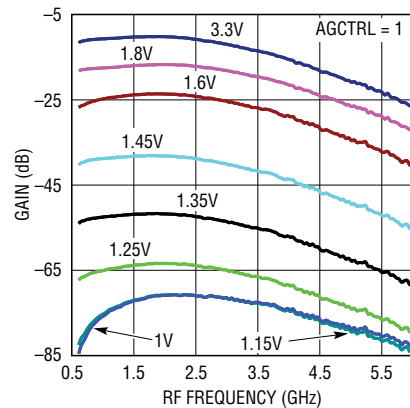

5589 G22

Output IP3 vs RF Frequency and V_{CTRL}

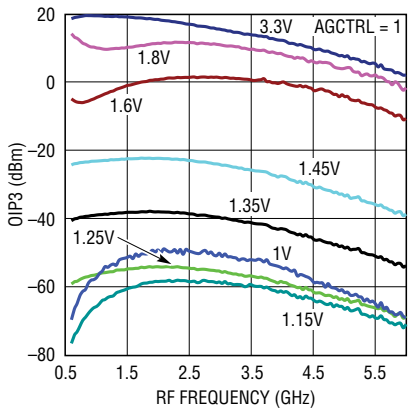

5589 G23

Output IP2 vs RF Frequency and V_{CTRL}

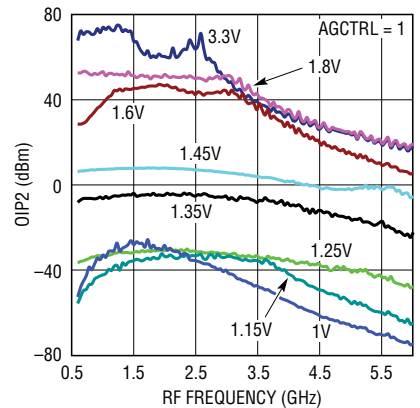

5589 G24

Noise Floor vs RF Frequency and V_{CTRL}

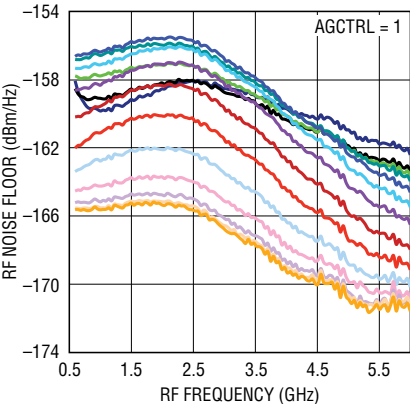

5589 G25

Noise Floor vs RF Frequency

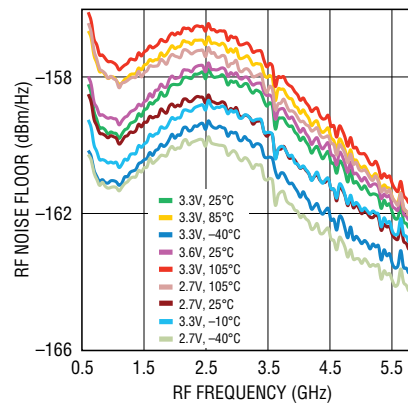

5589 G26

Noise Floor vs RF Power

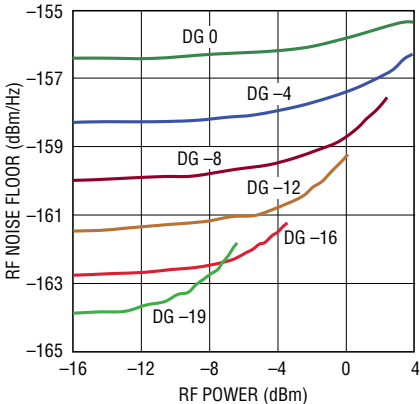

5589 G27

TYPICAL PERFORMANCE CHARACTERISTICS

$V_{CC} = 3.3V$, $EN = 3.3V$, $V_{CTRL} = 3.3V$, $T_C = 25^\circ C$, $P_{LO} = 0dBm$, $f_{LO} = 1.8GHz$, BBPI, BBMI, BBPQ, BBMQ common mode DC voltage $V_{CMBB} = 1.4V_{DC}$, I and Q baseband input signal = 2MHz, 2.1MHz, $1V_{P-P}(DIFF, I \text{ or } Q)$, I and Q 90° shifted, lower sideband selection, TEMPUPDT = 0, register 0x00 value according to Table 6, all other registers set to default values, unless otherwise noted. Test circuit is shown in Figure 12.

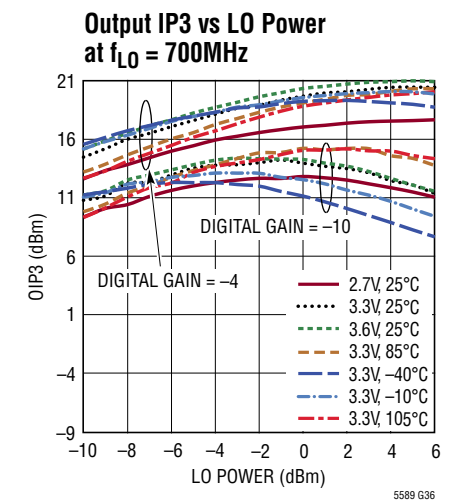
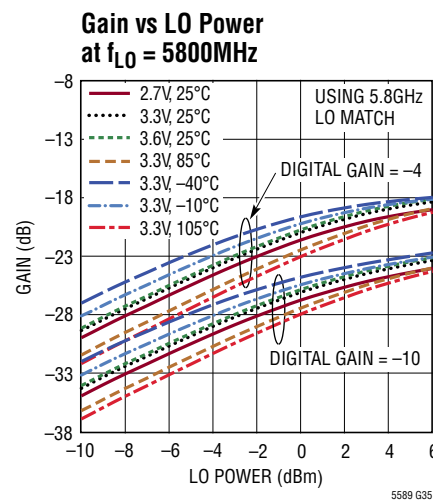
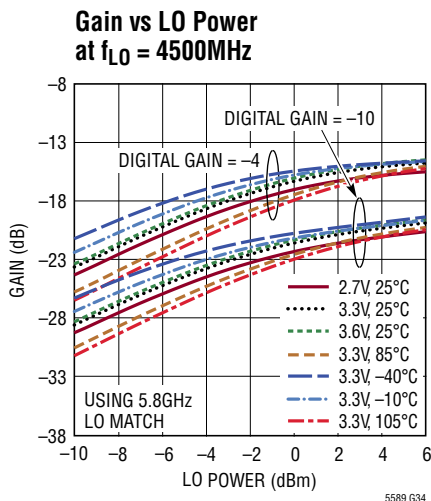
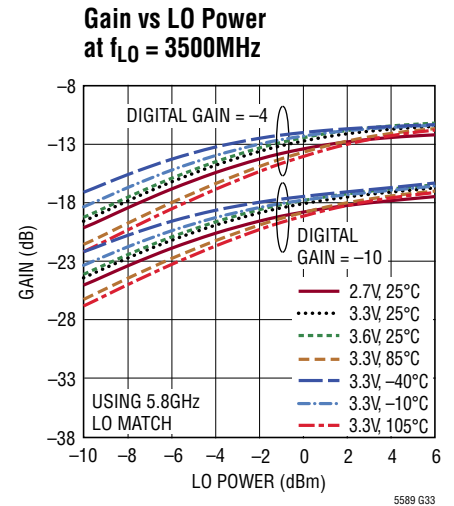
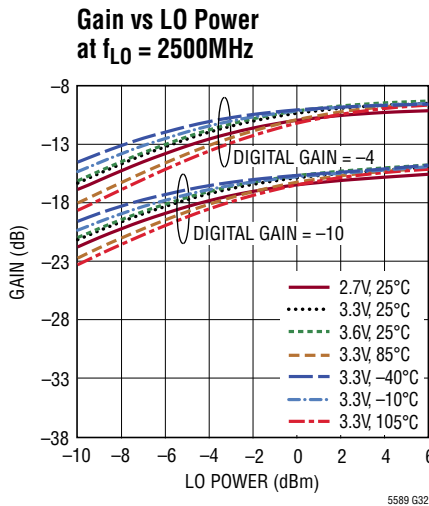
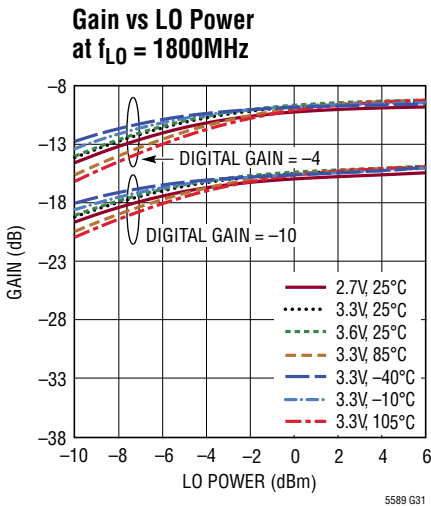
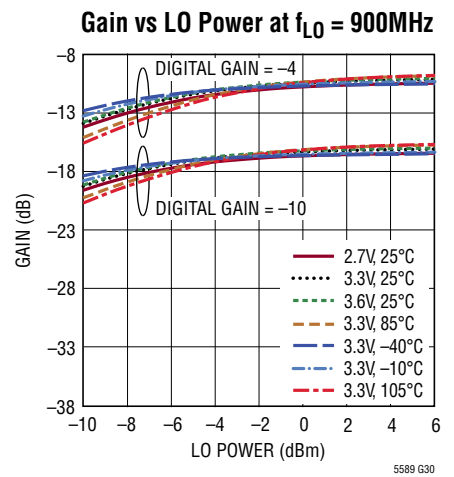
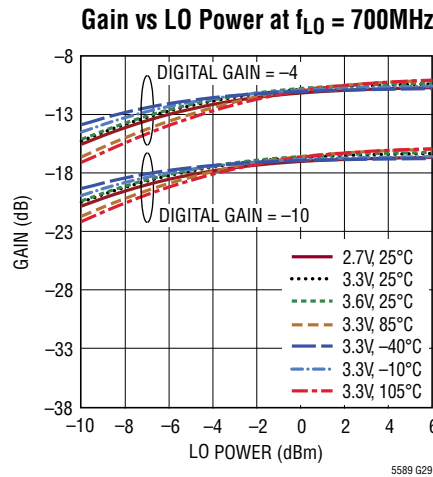
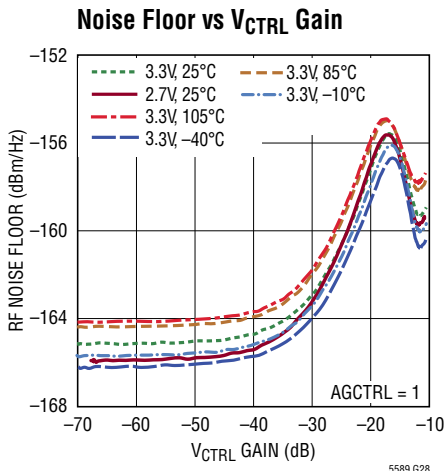

TYPICAL PERFORMANCE CHARACTERISTICS

$V_{CC} = 3.3V$, $EN = 3.3V$, $V_{CTRL} = 3.3V$, $T_C = 25^\circ C$, $P_{LO} = 0dBm$, $f_{LO} = 1.8GHz$, BBPI, BBMI, BBPQ, BBMQ common mode DC voltage $V_{CMBB} = 1.4V_{DC}$, I and Q baseband input signal = 2MHz, 2.1MHz, $1V_{P-P}(DIFF, I \text{ or } Q)$, I and Q 90° shifted, lower sideband selection, TEMPUPDT = 0, register 0x00 value according to Table 6, all other registers set to default values, unless otherwise noted. Test circuit is shown in Figure 12.

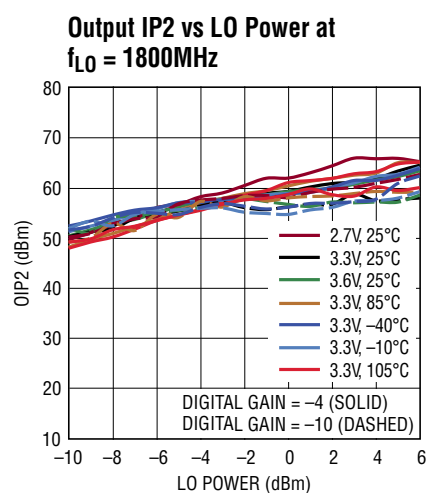
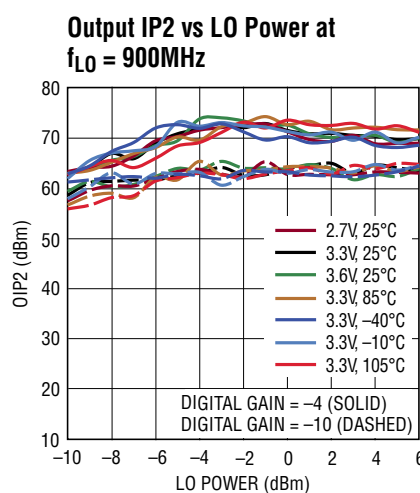
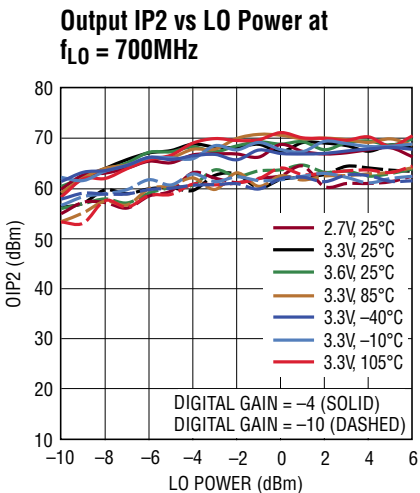
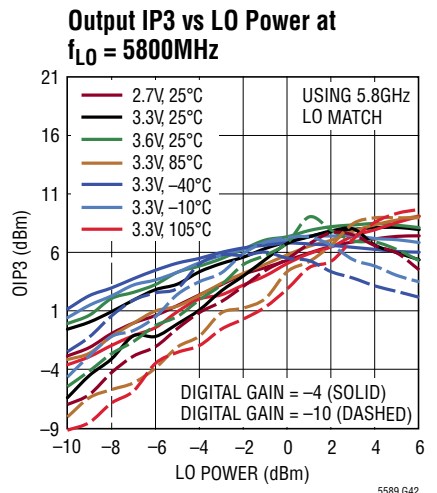
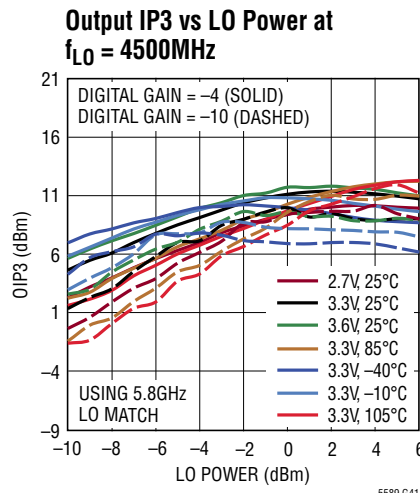
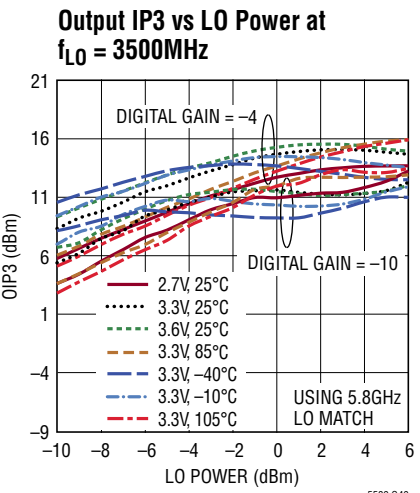
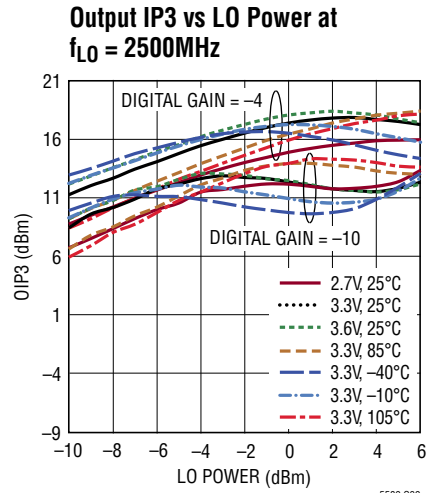
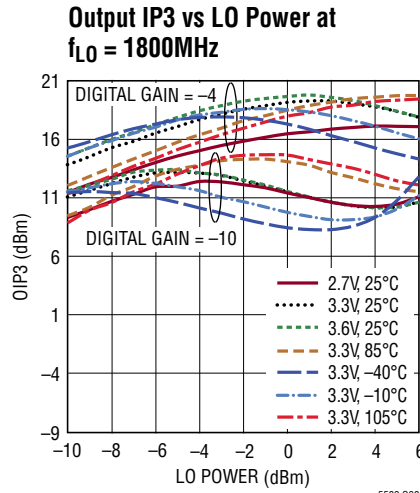
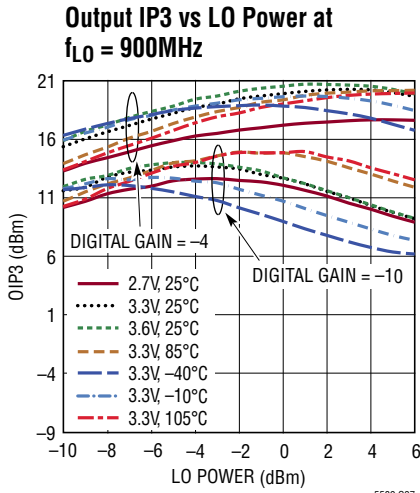

TYPICAL PERFORMANCE CHARACTERISTICS

$V_{CC} = 3.3V$, $EN = 3.3V$, $V_{CTRL} = 3.3V$, $T_C = 25^\circ C$, $P_{LO} = 0dBm$, $f_{LO} = 1.8GHz$, BBPI, BBMI, BBPQ, BBMQ common mode DC voltage $V_{CMBB} = 1.4V_{DC}$, I and Q baseband input signal = 2MHz, 2.1MHz, $1V_{P-P}(DIFF, I \text{ or } Q)$, I and Q 90° shifted, lower sideband selection, TEMPUPDT = 0, register 0x00 value according to Table 6, all other registers set to default values, unless otherwise noted. Test circuit is shown in Figure 12.

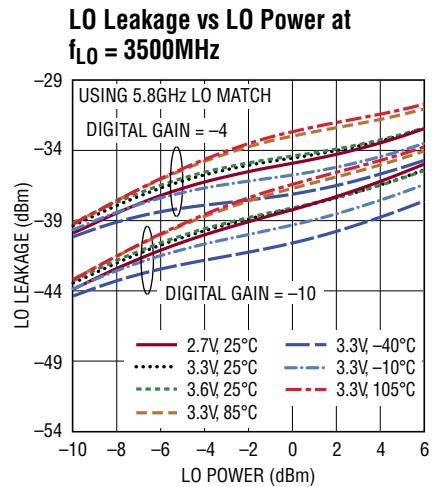
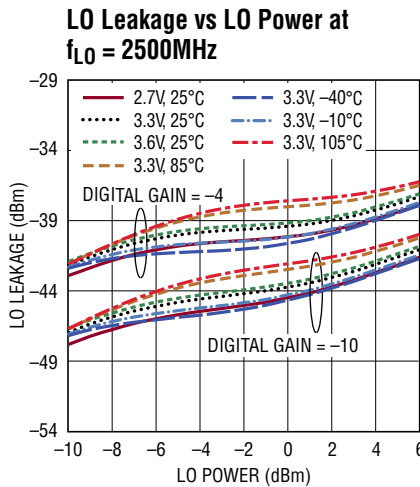
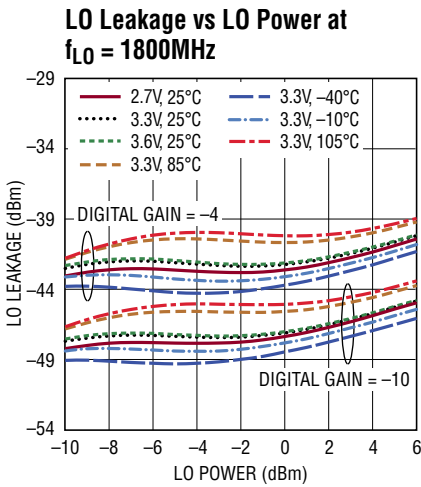
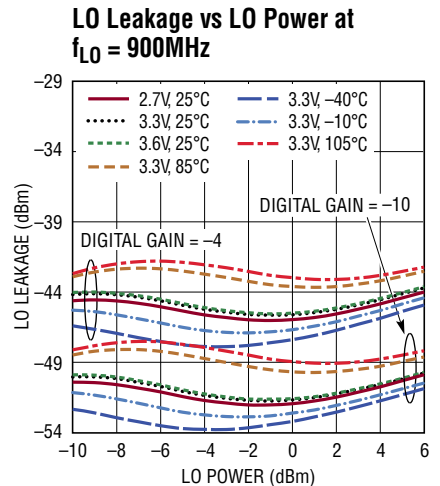
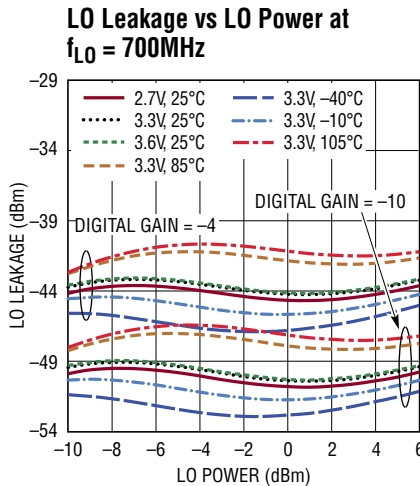
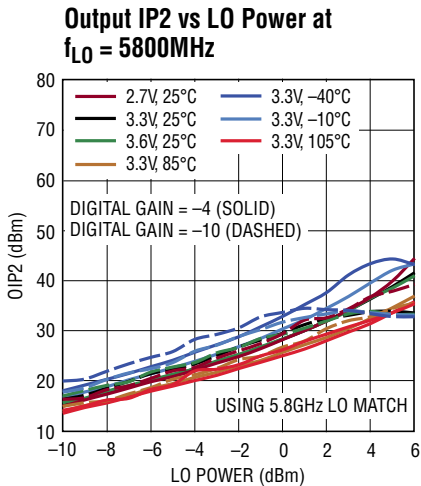
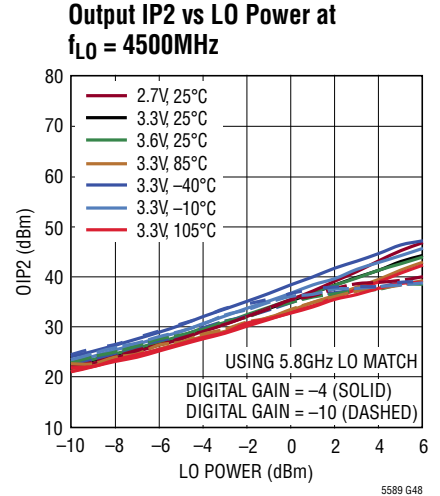
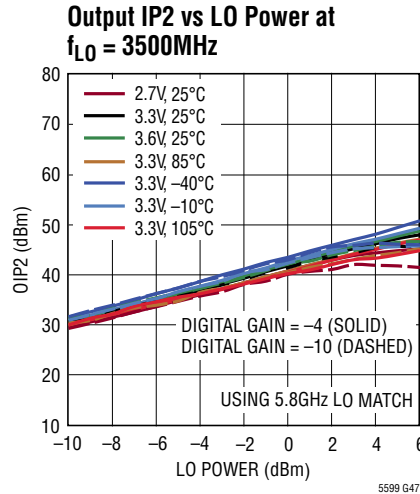
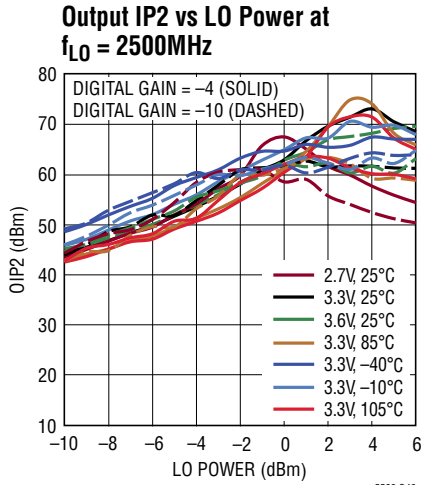

TYPICAL PERFORMANCE CHARACTERISTICS

$V_{CC} = 3.3V$, $EN = 3.3V$, $V_{CTRL} = 3.3V$, $T_C = 25^\circ C$, $P_{LO} = 0dBm$, $f_{LO} = 1.8GHz$, BBPI, BBMI, BBPQ, BBMQ common mode DC voltage $V_{CMBB} = 1.4V_{DC}$, I and Q baseband input signal = 2MHz, 2.1MHz, 1V_{P-P}(DIFF, I or Q), I and Q 90° shifted, lower sideband selection, TEMPUPDT = 0, register 0x00 value according to Table 6, all other registers set to default values, unless otherwise noted. Test circuit is shown in Figure 12.

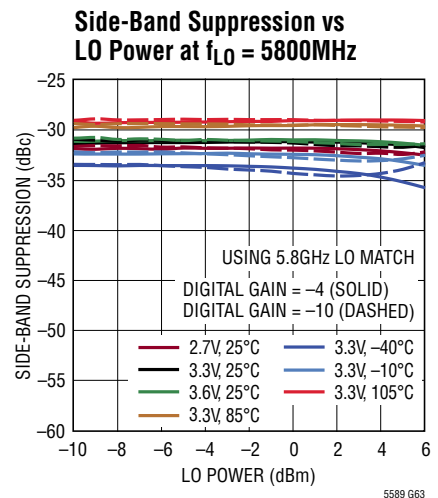
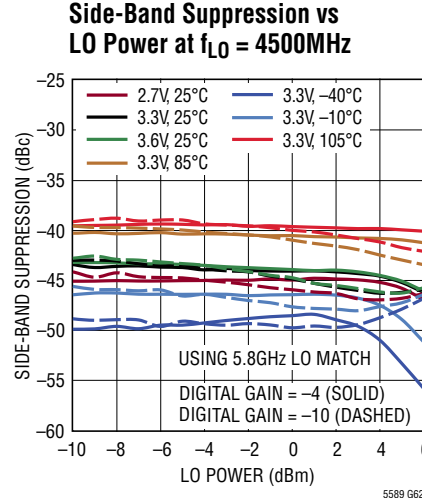
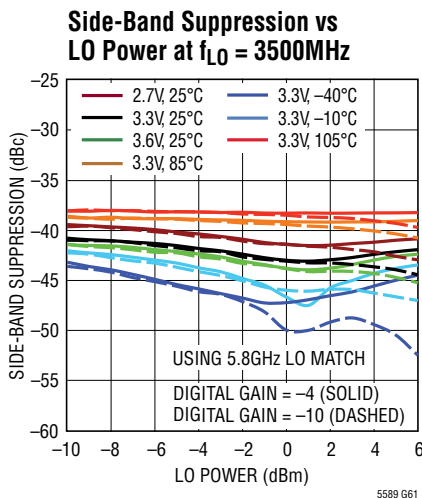
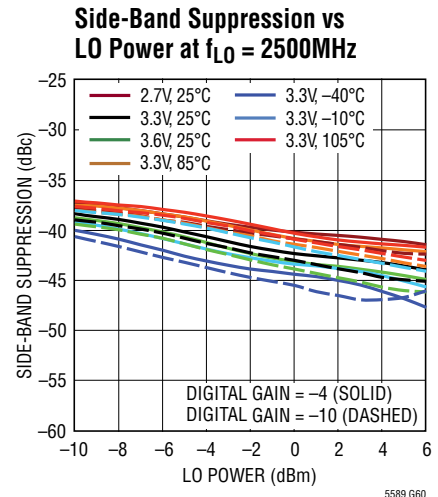
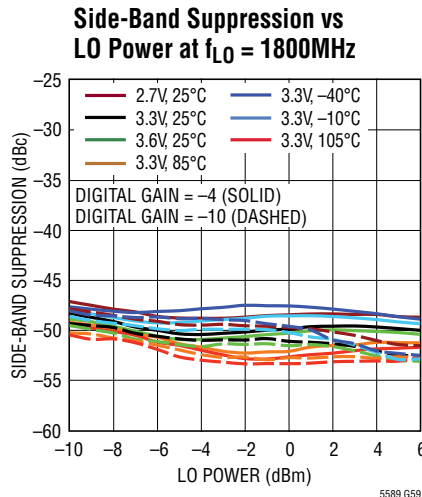
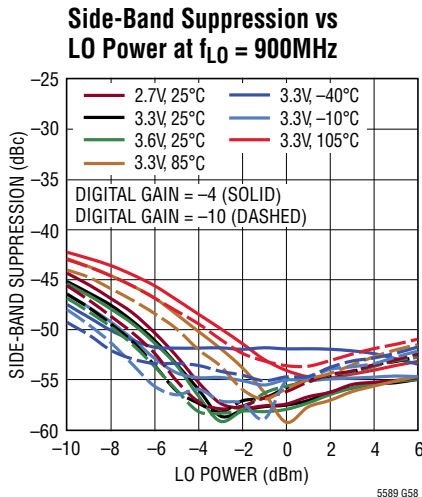
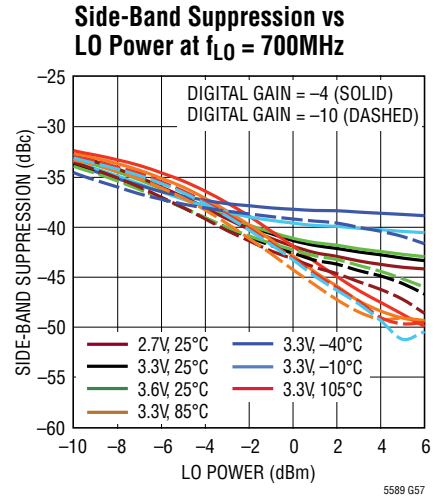
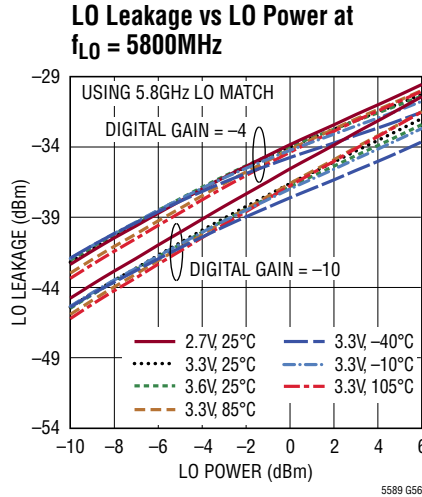
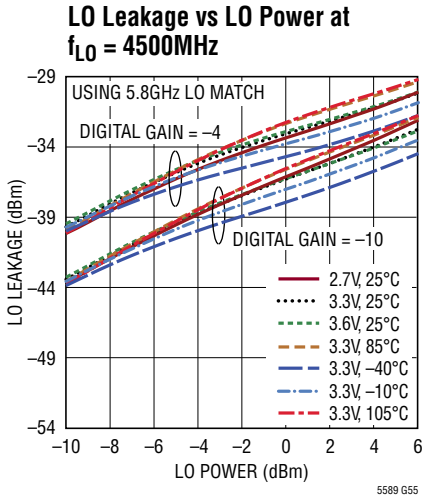

TYPICAL PERFORMANCE CHARACTERISTICS

$V_{CC} = 3.3V$, $EN = 3.3V$, $V_{CTRL} = 3.3V$, $T_C = 25^\circ C$, $P_{LO} = 0dBm$, $f_{LO} = 1.8GHz$, BBPI, BBMI, BBPQ, BBMQ common mode DC voltage $V_{CMBB} = 1.4V_{DC}$, I and Q baseband input signal = 2MHz, 2.1MHz, $1V_{P-P}(DIFF, I \text{ or } Q)$, I and Q 90° shifted, lower sideband selection, TEMPUPDT = 0, register 0x00 value according to Table 6, all other registers set to default values, unless otherwise noted. Test circuit is shown in Figure 12.

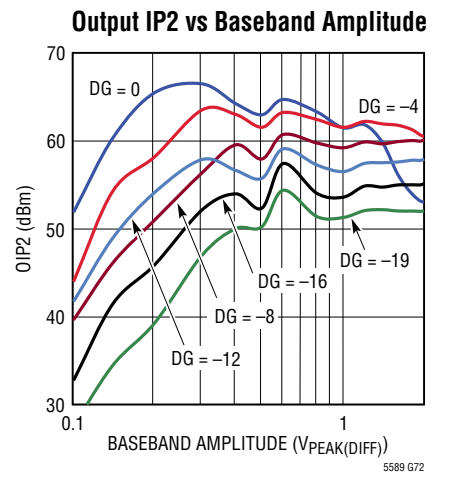
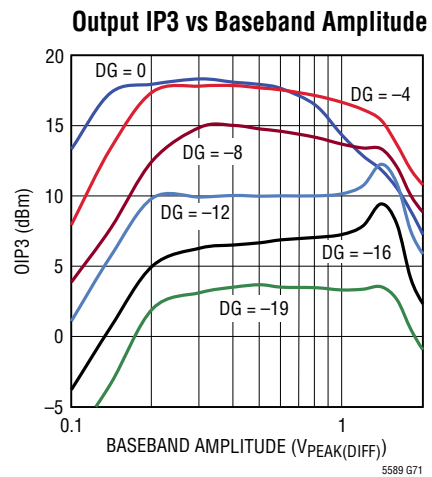
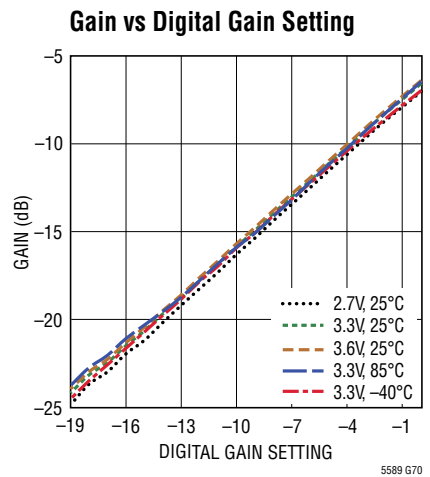
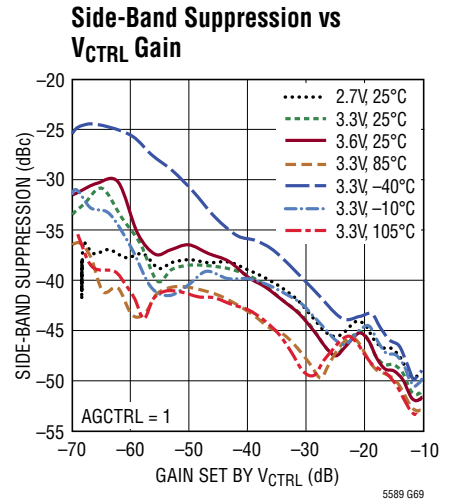
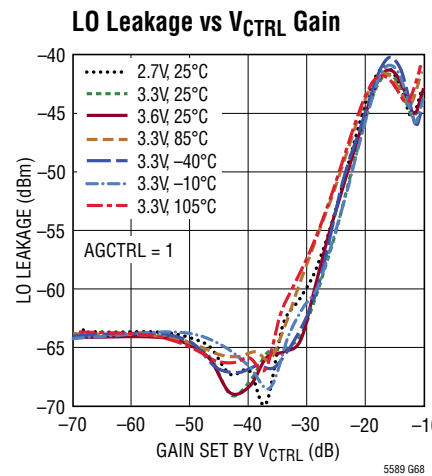
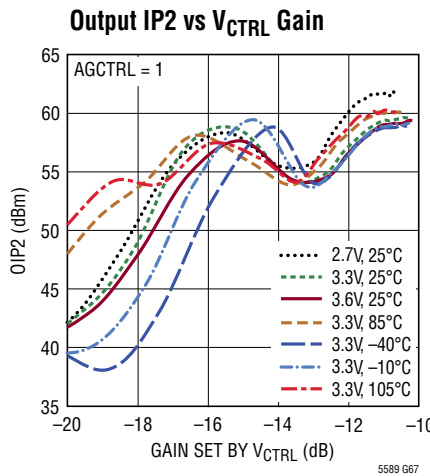
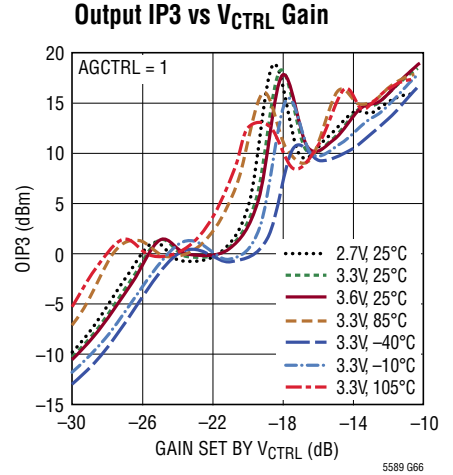
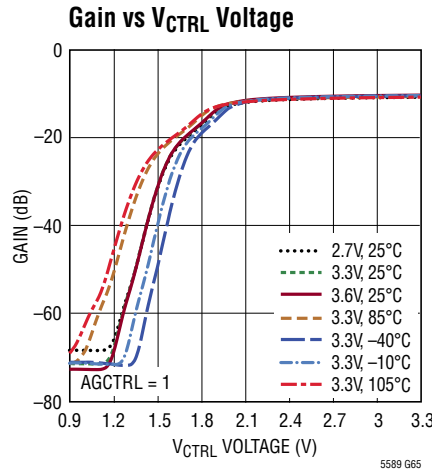
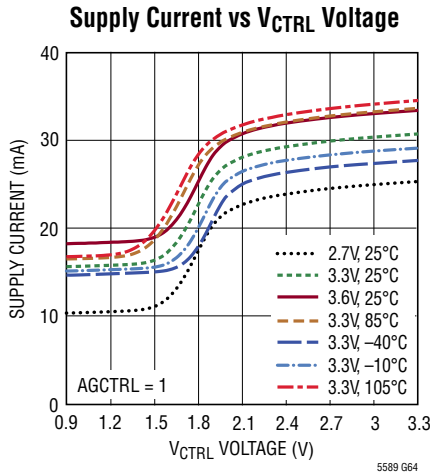

TYPICAL PERFORMANCE CHARACTERISTICS

$V_{CC} = 3.3V$, $EN = 3.3V$, $V_{CTRL} = 3.3V$, $T_C = 25^\circ C$, $P_{LO} = 0dBm$, $f_{LO} = 1.8GHz$, BBPI, BBMI, BBPQ, BBMQ common mode DC voltage $V_{CMBB} = 1.4V_{DC}$, I and Q baseband input signal = 2MHz, 2.1MHz, $1V_{P-P}(DIFF, I \text{ or } Q)$, I and Q 90° shifted, lower sideband selection, TEMPUPDT = 0, register 0x00 value according to Table 6, all other registers set to default values, unless otherwise noted. Test circuit is shown in Figure 12.

LO Leakage vs LO Frequency for Gain TempComp On

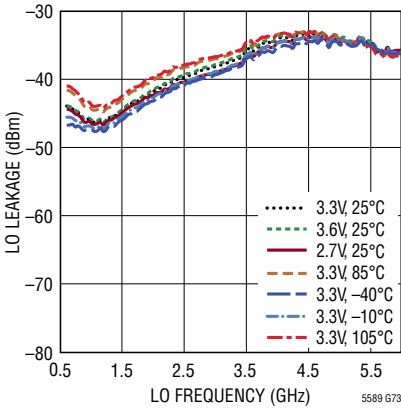

LO Leakage vs LO Frequency After 25°C, 3.3V Calibration Using Reg. 0x02 and 0x03, Gain TempComp Off

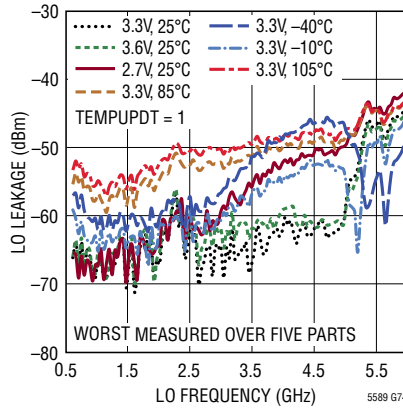

LO Leakage vs LO Frequency After 25°C, 3.3V Calibration Using Reg. 0x02 and 0x03, Gain TempComp On

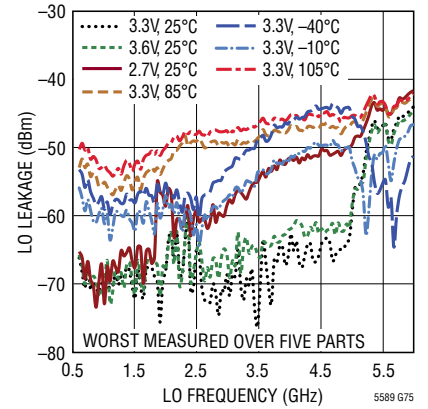

LO Leakage vs LO Frequency After 25°C, 2.7V Calibration Using Reg. 0x02 and 0x03, Gain TempComp Off

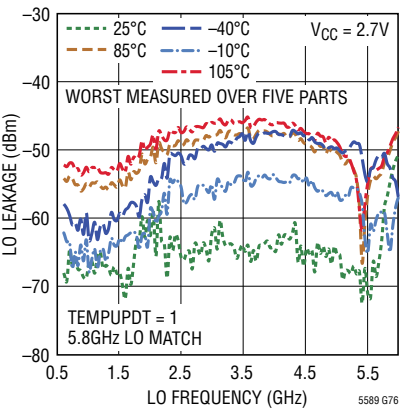

LO Leakage vs LO Frequency After 25°C, 2.7V Calibration Using Reg. 0x02 and 0x03, Gain TempComp On

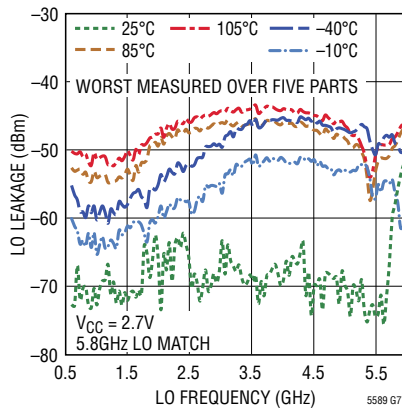

LO Leakage vs LO Frequency After 25°C, 3.3V Calibration Using I and Q Offset, Gain TempComp Off

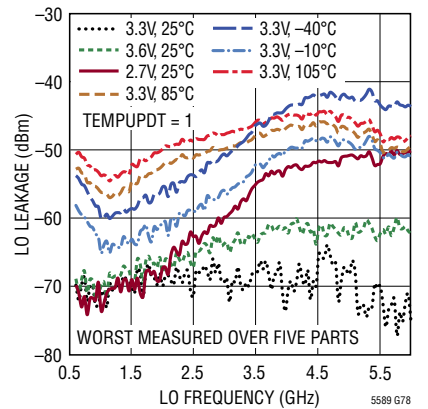

LO Leakage vs LO Frequency After 25°C, 3.3V Calibration Using I and Q Offset, Gain TempComp On

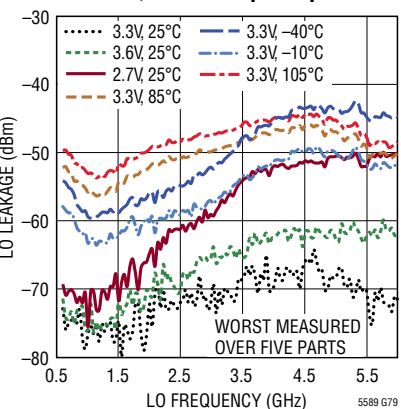

LO Leakage vs LO Frequency After 25°C, 2.7V Calibration Using I and Q Offset, Gain TempComp Off

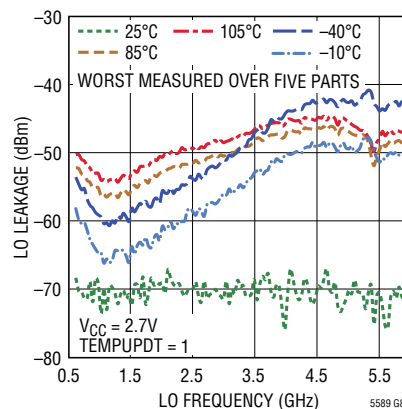

LO Leakage vs LO Frequency After 25°C, 2.7V Calibration Using I and Q Offset, Gain TempComp On

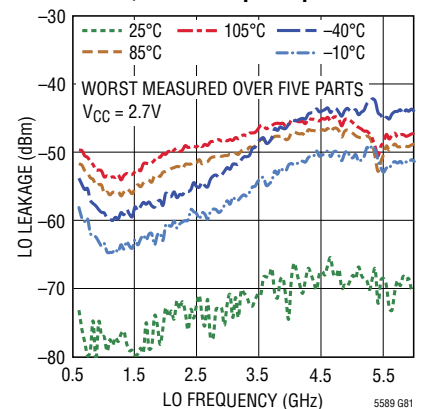

TYPICAL PERFORMANCE CHARACTERISTICS

$V_{CC} = 3.3V$, $V_{EN} = 3.3V$, $V_{CTRL} = 3.3V$, $T_C = 25^\circ C$, $P_{LO} = 0dBm$, $f_{LO} = 1.8GHz$, BBPI, BBMI, BBPQ, BBMQ common mode DC voltage $V_{CMBB} = 1.4V_{DC}$, I and Q baseband input signal = 2MHz, 2.1MHz, $1V_{P-P(DIFF, I \text{ or } Q)}$, I and Q 90° shifted, lower sideband selection, TEMPUPDT = 0, register 0x00 value according to Table 6, all other registers set to default values, unless otherwise noted. Test circuit is shown in Figure 12.

LO Leakage vs LO Frequency After 25°C, 3.3V Calibration with 5.8GHz Match Using Reg. 0x02 and 0x03, Gain TempComp Off

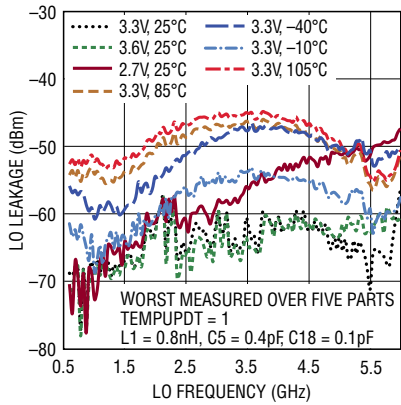

LO Leakage vs LO Frequency After 25°C, 3.3V Calibration with 5.8GHz Match Using Reg. 0x02 and 0x03, Gain TempComp On

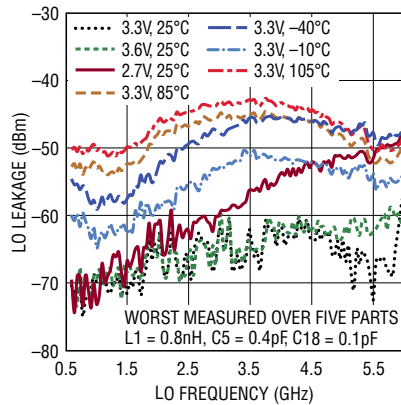

Side-Band Suppression vs LO Frequency After 25°C, 3.3V Calibration, Gain TempComp Off

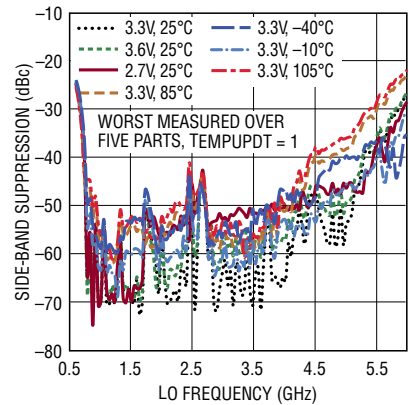

Side-Band Suppression vs LO Frequency After 25°C, 3.3V Calibration, Gain TempComp On

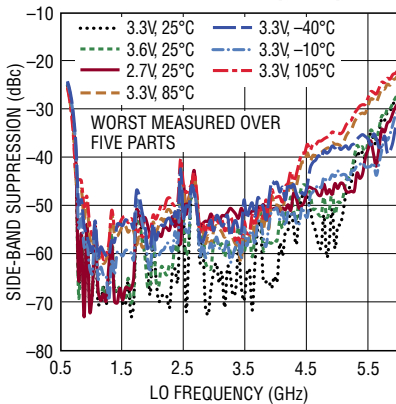

Side-Band Suppression vs LO Frequency After 25°C, 2.7V Calibration, Gain TempComp Off

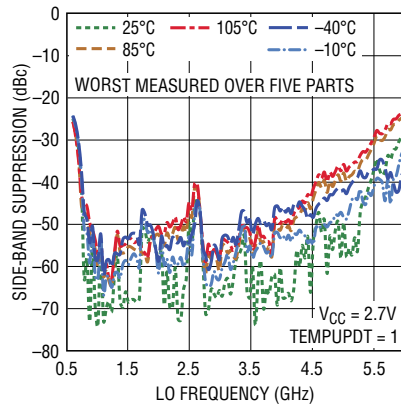

Side-Band Suppression vs LO Frequency After 25°C, 2.7V Calibration, Gain TempComp On

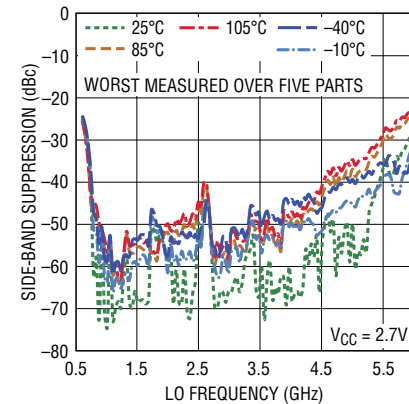

Side-Band Suppression vs LO Frequency Using 5.8GHz Match

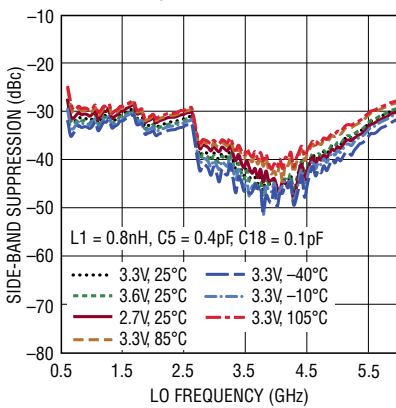

Side-Band Suppression vs LO Frequency After 25°C, 3.3V Calibration with 5.8GHz Match Using Reg. 0x02 and 0x03, Gain TempComp Off

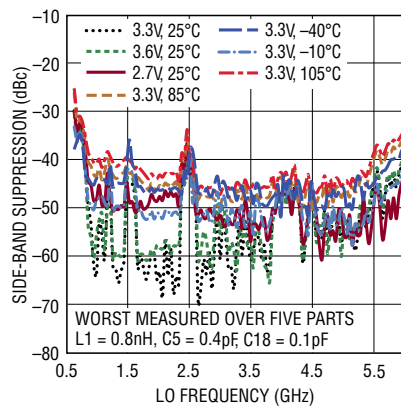

Side-Band Suppression vs LO Frequency After 25°C, 3.3V Calibration with 5.8GHz Match Using Reg. 0x02 and 0x03, Gain TempComp On

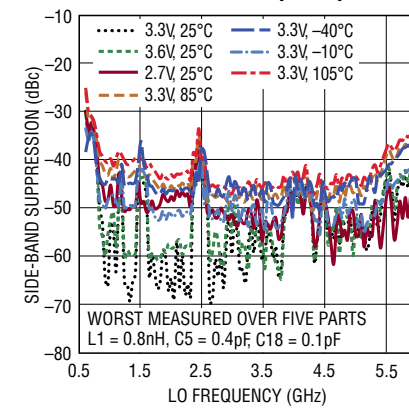

TYPICAL PERFORMANCE CHARACTERISTICS

$V_{CC} = 3.3V$, $V_{EN} = 3.3V$, $V_{CTRL} = 3.3V$, $T_C = 25^\circ C$, $P_{LO} = 0dBm$, $f_{LO} = 1.8GHz$, BBPI, BBMI, BBPQ, BBMQ common mode DC voltage $V_{CMBB} = 1.4V_{DC}$, I and Q baseband input signal = 2MHz, 2.1MHz, 1V_{P-P}(DIFF, I or Q), I and Q 90° shifted, lower sideband selection, TEMPUPDT = 0, register 0x00 value according to Table 6, all other registers set to default values, unless otherwise noted. Test circuit is shown in Figure 12.

LO Leakage vs LO Frequency and Digital Gain Setting After Calibration Using Reg. 0x02 and 0x03 at Digital Gain = -4

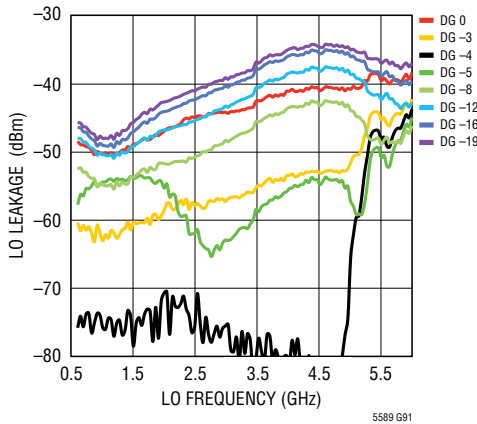

Side-Band Suppression vs LO Frequency and Digital Gain Setting After Calibration at Digital Gain = -4

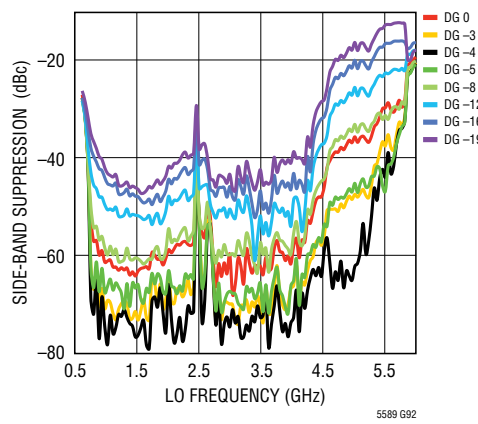

Temperature Sensing Diode Voltage Cumulative Distribution

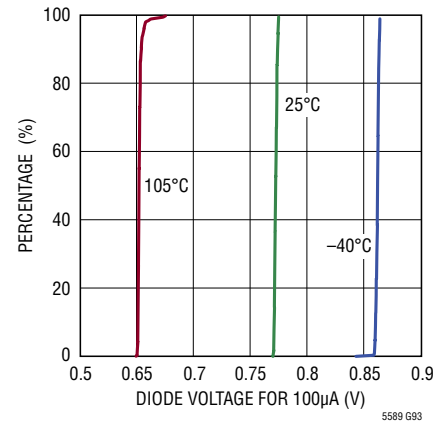

Supply Current Cumulative Distribution

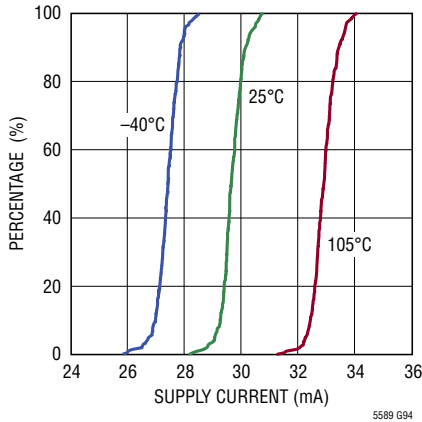

Gain Cumulative Distribution for Gain TempComp On

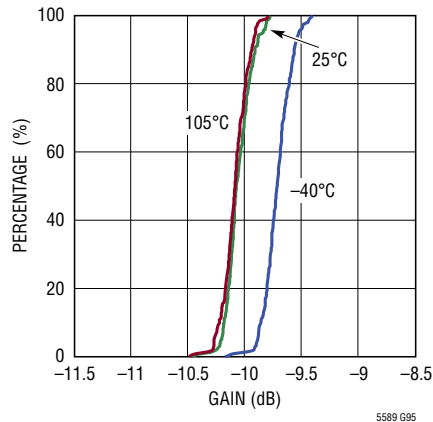

Sleep Current Cumulative Distribution

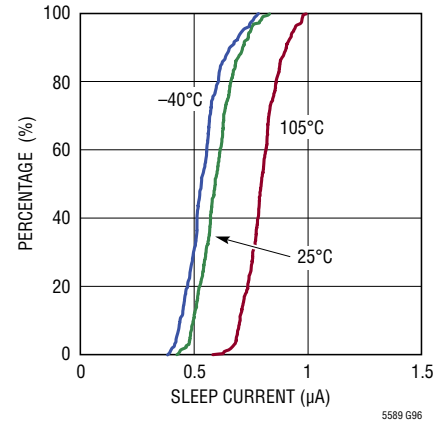

Gain Cumulative Distribution for Gain TempComp Off

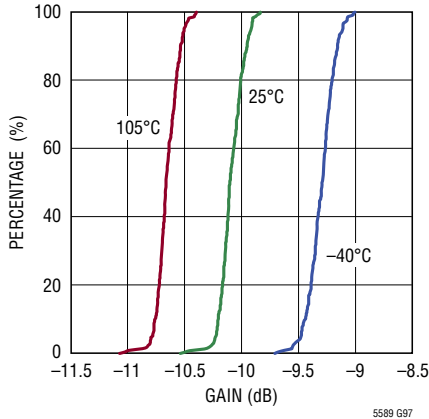

Gain Cumulative Distribution for V_{CTRL} = 1.75V

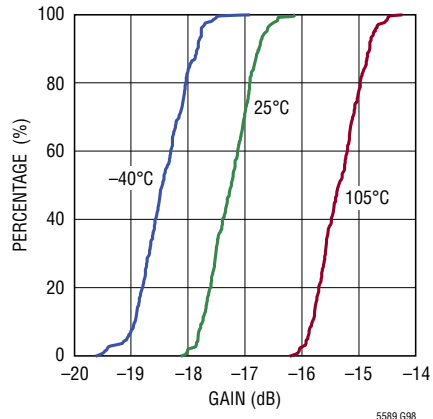

Gain Cumulative Distribution for V_{CTRL} = 1V

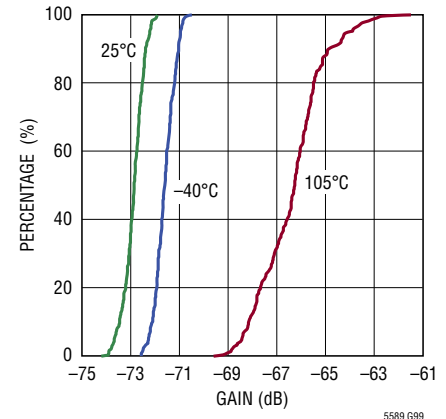

TYPICAL PERFORMANCE CHARACTERISTICS

$V_{CC} = 3.3V$, $V_{EN} = 3.3V$, $V_{CTRL} = 3.3V$, $T_C = 25^\circ C$, $P_{LO} = 0dBm$, $f_{LO} = 1.8GHz$, BBPI, BBMI, BBPQ, BBMQ common mode DC voltage $V_{CMBB} = 1.4V_{DC}$, I and Q baseband input signal = 2MHz, 2.1MHz, $1V_{P-P}(DIFF, I \text{ or } Q)$, I and Q 90° shifted, lower sideband selection, TEMPUPDT = 0, register 0x00 value according to Table 6, all other registers set to default values, unless otherwise noted. Test circuit is shown in Figure 12.

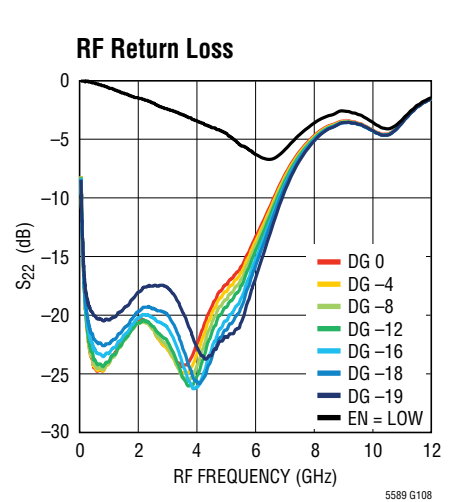
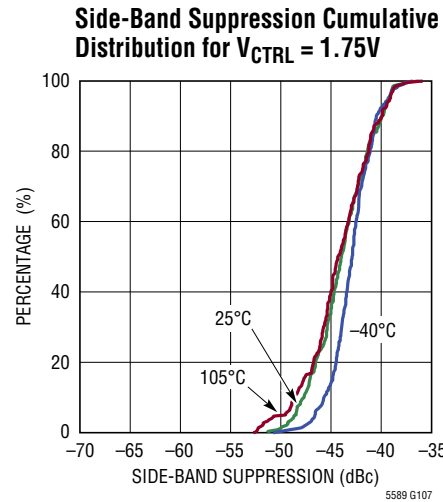
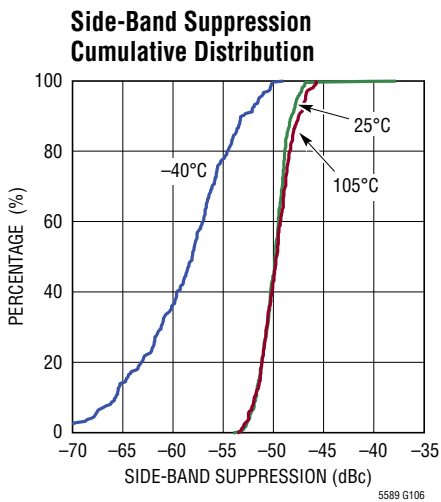
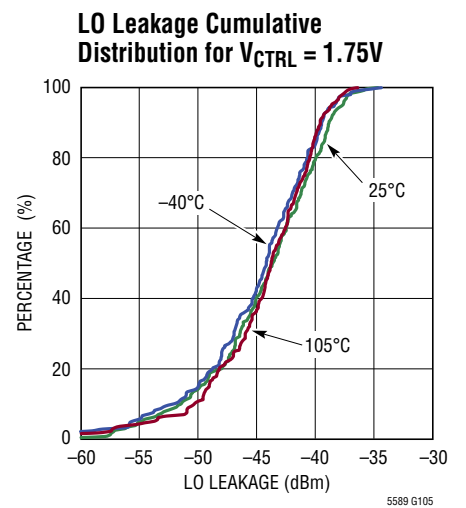
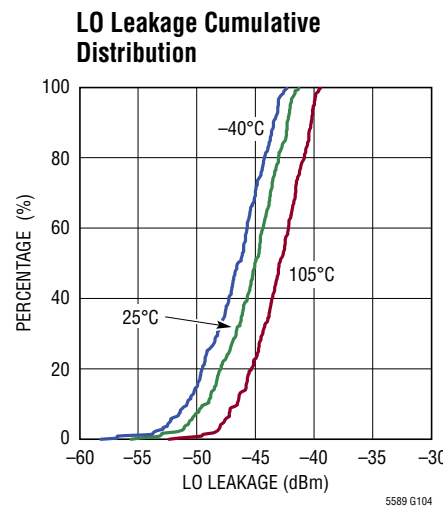
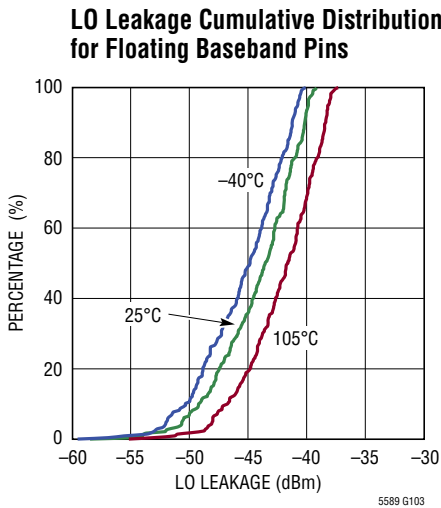
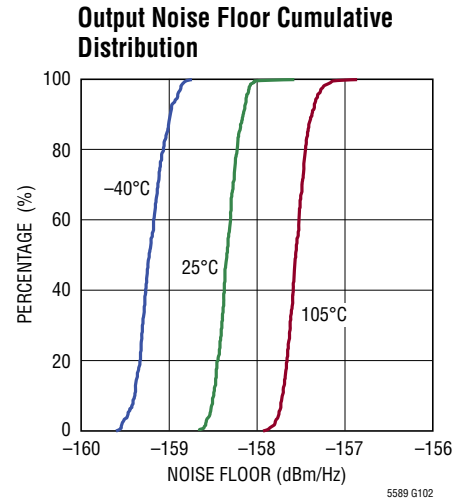
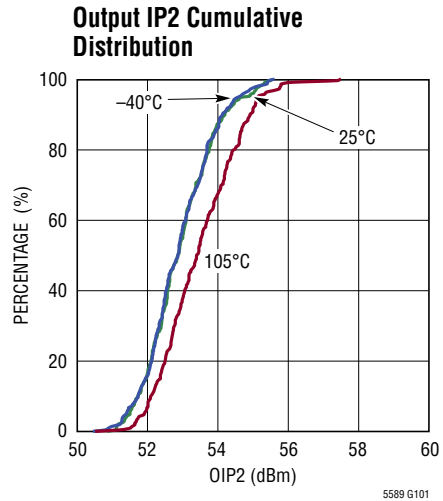
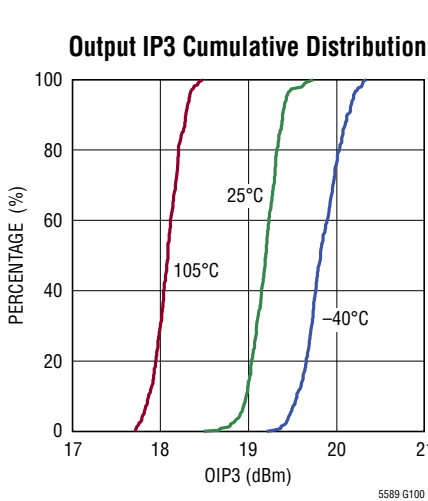

TYPICAL PERFORMANCE CHARACTERISTICS

$V_{CC} = 3.3V$, $V_{EN} = 3.3V$, $V_{CTRL} = 3.3V$, $T_C = 25^\circ C$, $P_{LO} = 0dBm$, $f_{LO} = 1.8GHz$, BBPI, BBMI, BBPQ, BBMQ common mode DC voltage $V_{CMBB} = 1.4V_{DC}$, I and Q baseband input signal = 2MHz, 2.1MHz, $1V_{P-P(DIFF, I \text{ or } Q)}$, I and Q 90° shifted, lower sideband selection, TEMPUPDT = 0, register 0x00 value according to Table 6, all other registers set to default values, unless otherwise noted. Test circuit is shown in Figure 12.

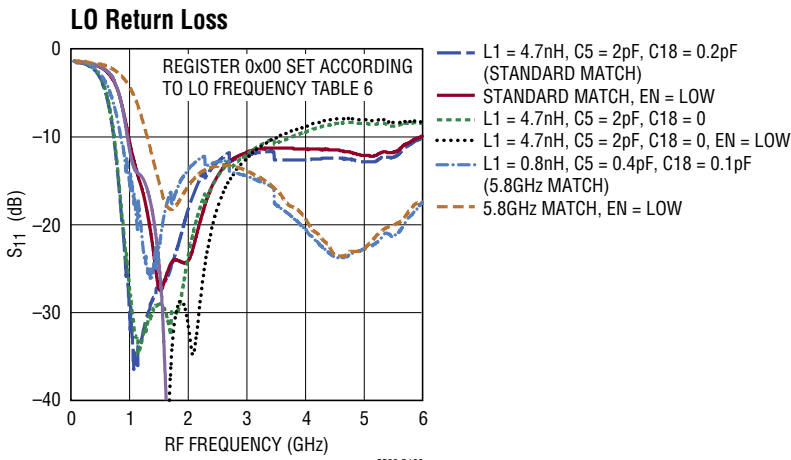

RMS EVM vs RF Output Power at $f_{LO} = 2.17GHz$ with 1Ms/s 16-QAM Signal

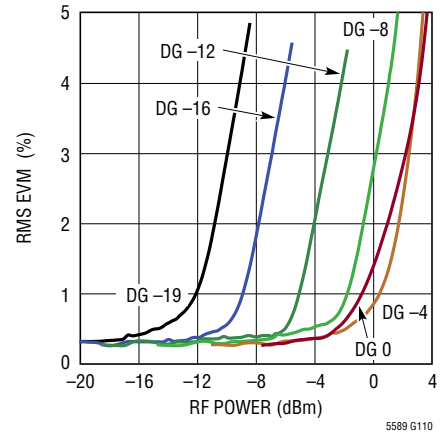

Peak EVM vs RF Output Power at $f_{LO} = 2.17GHz$ with 1Ms/s 16-QAM Signal

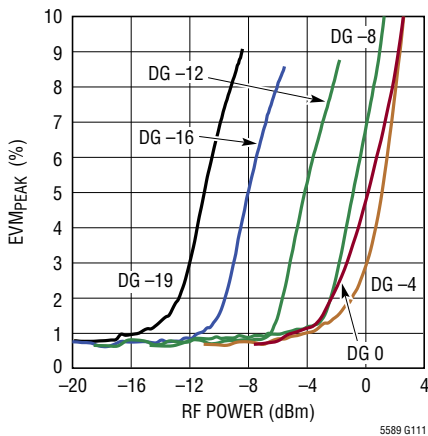

RMS EVM vs RF Output Power at $f_{LO} = 5.8GHz$ with 1Ms/s 16-QAM Signal

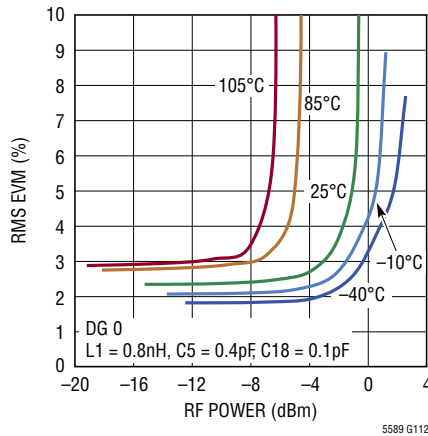

RMS EVM vs RF Output Power at $f_{LO} = 5.8GHz$ with 1Ms/s 16-QAM Signal After $25^\circ C$, 3.3V Calibration

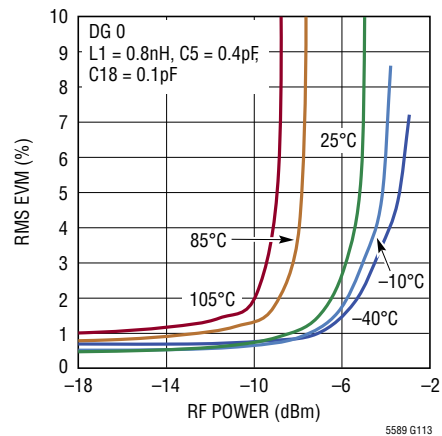

PIN FUNCTIONS

V_{CTRL} (Pin 1): Variable Gain Control Input. This analog control pin sets the gain. Write a “1” to bit 6 in register 0x01 (AGCTRL = 1) to activate this pin, resulting in about 2.5mA current draw from a positive supply. Typical V_{CTRL} voltage range is 0.9V to 3.3V. Gain transfer function is not linear-in-dB. Tie to V_{CC} when not used.

GND (Pins 2, 5, 12, 13, 14, 15, 17, 18, Exposed Pad 25): Ground. All these pins are connected together internally. For best RF performance all ground pins should be connected to RF ground.

LOL, LOC (Pins 3, 4): LO Inputs. This is not a differential input. Both pins are 50Ω inputs. An LC diplexer is recommended to be used at these pins (see Figure 12). AC-coupling capacitors are required at these pins if the applied DC level is higher than ±50mV.

TTCK (Pin 6): Temperature Update. When the TTCK temperature update mode is selected in register 0x01 (bit 7 = High, TEMPUPDT = 1), the temperature readout and digital gain compensation vs temperature can be updated through a logic low to logic high transition at this pin. Do not float.

TEMP (Pin 7): Temperature Sensing Diode. This pin is connected to the anode of a diode that may be used to measure the die temperature, by forcing a current and measuring the voltage. This diode is not part of the on-chip thermometer.

BBPI, BBMI (Pins 8, 9): Baseband Inputs of the I-Channel. The input impedance of each input is about 1kΩ. It should be externally biased to a 1.4V common mode level, or AC-coupled. Do not apply common mode voltage beyond 2V_{DC}.

BBPQ, BBMQ (Pins 10, 11): Baseband Inputs of the Q-Channel. The input impedance of each input is about 1kΩ. It should be externally biased to a 1.4V common mode level, or AC-coupled. Do not apply common mode voltage beyond 2V_{DC}. Float if Q-channel is disabled.

RF (Pin 16): RF Output. The output impedance at RF frequencies is 50Ω. Its DC output voltage is about 1.7V if enabled. An AC-coupling capacitor should be used at this pin with a recommended value of 100pF.

CSB (Pin 19): Serial Port Chip Select. This CMOS input initiates a serial port transaction when driven low, ending the transaction when driven back high. Do not float.

SCLK (Pin 20): Serial Port Clock. This CMOS input clocks serial port input data on its rising edge. Do not float.

SDI (Pin 21): Serial Port Data Input. The serial port uses this CMOS input for data. Do not float.

SDO (Pin 22): Serial Port Data Output. This NMOS output presents data from the serial port during a read transaction. Connect this pin to the digital supply voltage through a pull-up resistor of sufficiently large value, to ensure that the current does not exceed 10mA when pulled low.

EN (Pin 23): Enable Pin. The chip is completely turned on when a logic high voltage is applied to this pin, and completely turned off for a logic low voltage. Do not float.

V_{CC} (Pin 24): Power Supply. It is recommended to use 1nF and 4.7μF capacitors for decoupling to ground on this pin.

BLOCK DIAGRAM

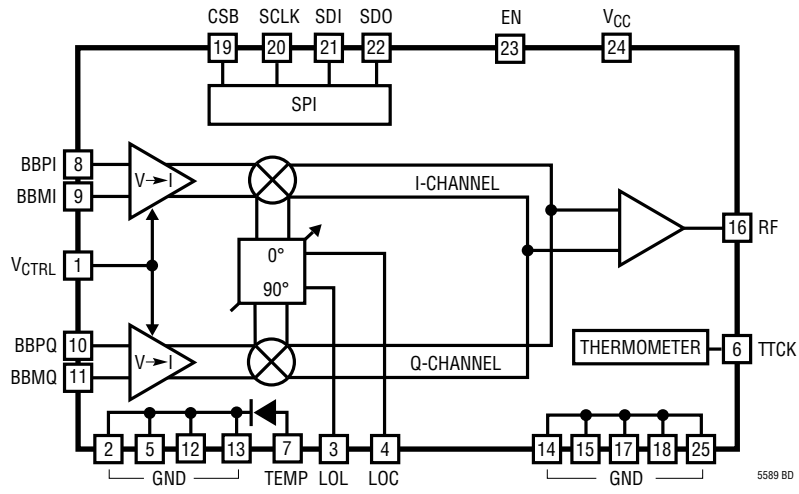

APPLICATIONS INFORMATION

The LTC5589 consists of I and Q input differential voltage-to-current converters, I and Q upconverting mixers, an RF output buffer and an LO quadrature phase generator. An SPI bus addresses nine control registers, enabling optimization of side-band suppression, LO leakage, and adjustment of the modulator gain. See Table 1 for a summary of the writable registers and their default values. A full map of all the registers in the LTC5589 is listed in Table 8 and Table 9 in the Appendix.

Table 1. SPI Writable Registers and Default Register Values.

| ADDRESS | DEFAULT VALUE | SETTING | REGISTER FUNCTION |
|---------|---------------|---------|---------------------------------|
| 0x00 | 0x3E | 2.56GHz | LO Frequency Tuning |
| 0x01 | 0x84 | DG = -4 | Gain |
| 0x02 | 0x80 | 0mV | Offset I-Channel |
| 0x03 | 0x80 | 0mV | Offset Q-Channel |
| 0x04 | 0x80 | 0dB | I/Q Gain Ratio |
| 0x05 | 0x10 | 0° | I/Q Phase Balance |
| 0x06 | 0x50 | OFF | LO Port Matching Override |
| 0x07 | 0x06 | OFF | Temperature Correction Override |
| 0x08 | 0x00 | NORMAL | Operating Mode |

Without using the SPI the registers will use the default values which may not result in the optimum side-band suppression (SB). For example: for LO frequency from about 2.44GHz to about 2.72GHz, the SB is about -40dBc; from 1.7GHz to 2.44GHz and 2.72GHz to 2.93GHz it falls to about -35dBc.

Aside of powering up the LTC5589, the register values can be reset to the default values by setting SRESET = 1 (bit 3, register 0x08). After about 50ns SRESET is automatically set back to 0.

External I and Q baseband signals are applied to the differential baseband input pins: BBPI, BBMI and BBPQ, BBMQ. These voltage signals are converted to currents and translated to RF frequency by means of double-balanced upconverting mixers. The mixer outputs are combined at the inputs of the RF output buffer, which also transforms the output impedance to 50Ω. The center frequency of the resulting RF signal is equal to the LO signal frequency.

The LO inputs drive a phase shifter which splits the LO signal into in-phase and quadrature signals which drive the upconverting mixers. In most applications, the LOL input is driven by the LO source via a 4.7nH inductor, while the LOC input is driven by the LO source via a 2pF capacitor. This inductor and capacitor form a diplexer circuit tuned to 1.4GHz. The RF output is single-ended and internally 50Ω matched across a wide RF frequency range from 55MHz to 6.6GHz with better than 10dB return loss using C4 = 100pF and C17 = 0.2pF. See Figure 12.

Baseband Interface

The baseband inputs (BBPI, BBMI, BBPQ, BBMQ) present a differential input impedance of about 1.8kΩ, as depicted in Figure 1. The baseband bandwidth depends on the source impedance and the frequency setting (register 0x00). It is recommended to compensate the baseband input impedance in the baseband lowpass filter design in order to achieve best gain flatness vs baseband frequency. The S-parameters for (each of) the baseband inputs are given in Table 2 for various LO frequency and gain settings.

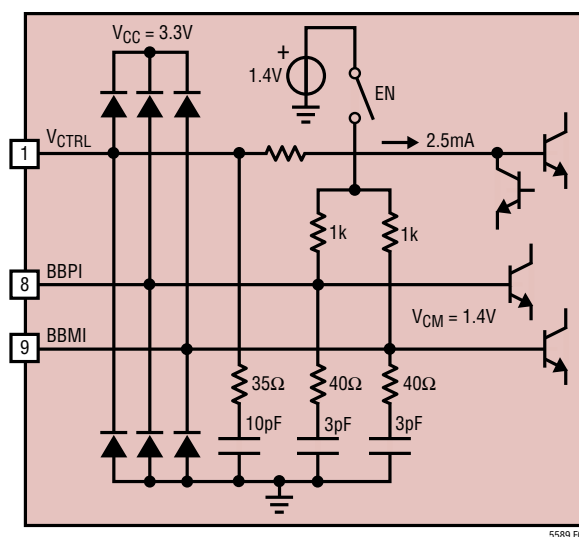

Figure 1. Simplified Circuit Schematic of the Base Band Input Interface (Only One Channel Is Shown).

APPLICATIONS INFORMATION

Table 2. Differential Baseband (BB) Input Impedance vs Frequency for EN = High and $V_{CMBB} = 1.4V$

| BB FREQUENCY (MHz) | INPUT IMPEDANCE (Ω) | | REFL COEFFICIENT | |
|--|------------------------------|----------------|------------------|----------|
| | REAL* | IMAG* (CAP) | MAG | ANGLE(°) |
| LO FREQUENCY = 0.8GHz (REG. 0x00 = 0x70), DIGITAL GAIN = -4dB | | | | |
| 1 | 1.84k | -12.8k (12pF) | 0.897 | -0.9 |
| 10 | 1.76k | -1.4k (11.3pF) | 0.893 | -8.2 |
| 20 | 1.55k | -705 (11.2pF) | 0.881 | -16 |
| 40 | 1.08k | -360 (11pF) | 0.841 | -31 |
| 100 | 368 | -157 (9.8pF) | 0.680 | -68 |
| LO FREQUENCY = 1.8GHz (REG. 0x00 = 0x4B), DIGITAL GAIN = -4dB | | | | |
| 1 | 1.84k | -16.8k (9.2pF) | 0.897 | -0.7 |
| 10 | 1.79k | -1.74k (9.1pF) | 0.895 | -6.6 |
| 20 | 1.65k | -876 (9pF) | 0.887 | -13 |
| 40 | 1.27 | -444 (8.9pF) | 0.860 | -26 |
| 100 | 501 | -186 (8.3pF) | 0.733 | -58 |
| 200 | 204 | -113 (6.9pF) | 0.591 | -91 |
| LO FREQUENCY = 2.5GHz (REG. 0x00 = 0x3F), DIGITAL GAIN = -4dB | | | | |
| 1 | 1.84k | -17.7k (8.7pF) | 0.897 | -0.6 |
| 10 | 1.8k | -1.84k (8.6pF) | 0.895 | -6.2 |
| 20 | 1.67k | -924 (8.5pF) | 0.888 | -12 |
| 40 | 1.31k | -468 (8.5pF) | 0.864 | -24 |
| 100 | 539 | -194 (7.9pF) | 0.745 | -56 |
| 200 | 219 | -116 (6.7pF) | 0.602 | -89 |
| 400 | 100 | -81 (4.8pF) | 0.524 | -122 |
| LO FREQUENCY = 3.8GHz (REG. 0x00 = 0x2B), DIGITAL GAIN = -4dB | | | | |
| 1 | 1.84k | -18.8k (8.2pF) | 0.897 | -0.6 |
| 10 | 1.8k | -1.96k (8.1pF) | 0.895 | -5.9 |
| 20 | 1.69k | -985 (8pF) | 0.889 | -12 |
| 40 | 1.36k | -499 (7.9pF) | 0.868 | -23 |
| 100 | 585 | -206 (7.5pF) | 0.758 | -53 |
| 200 | 238 | -120 (6.4pF) | 0.616 | -85 |
| 400 | 106 | -83 (4.7pF) | 0.528 | -119 |
| LO FREQUENCY = 5.8GHz (REG. 0x00 = 0x1A), DIGITAL GAIN = -4dB | | | | |
| 1 | 1.84k | -19.6k (7.8pF) | 0.897 | -0.6 |
| 10 | 1.81k | -2k (7.8pF) | 0.895 | -5.7 |
| 20 | 1.69k | -1.02 (7.7pF) | 0.890 | -11 |
| 40 | 1.38k | -516 (7.7pF) | 0.869 | -22 |
| 100 | 611 | -212 (7.2pF) | 0.765 | -51 |
| 200 | 250 | -123 (6.3pF) | 0.623 | -84 |
| 400 | 110 | -84 (4.6pF) | 0.530 | -118 |

Table 2. Differential Baseband (BB) Input Impedance vs Frequency for EN = High and $V_{CMBB} = 1.4V$ (continued)

| BB FREQUENCY (MHz) | INPUT IMPEDANCE (Ω) | | REFL COEFFICIENT | |
|---|------------------------------|----------------|------------------|----------|
| | REAL* | IMAG* (CAP) | MAG | ANGLE(°) |
| LO FREQUENCY = 1.8GHz (REG. 0x00 = 0x4B), DIGITAL GAIN = 0dB | | | | |
| 1 | 1.78k | -16.9k (9.1pF) | 0.902 | -0.7 |
| 10 | 1.73k | -1.75k (9pF) | 0.891 | -6.6 |
| 20 | 1.6k | -878 (9pF) | 0.884 | -13 |
| 40 | 1.24k | -445 (8.9pF) | 0.857 | -25 |
| 100 | 497 | -186 (8.3pF) | 0.732 | -58 |
| 200 | 203 | -113 (6.8pF) | 0.590 | -91 |
| LO FREQUENCY = 1.8GHz (REG. 0x00 = 0x4B), DIGITAL GAIN = -19dB | | | | |
| 1 | 1.94k | -16.7k (9.2pF) | 0.893 | -0.7 |
| 10 | 1.88k | -1.74k (9.1pF) | 0.899 | -6.6 |
| 20 | 1.72k | -874 (9pF) | 0.892 | -13 |
| 40 | 1.31k | -443 (8.9pF) | 0.865 | -26 |
| 100 | 507 | -185 (8.3pF) | 0.736 | -58 |
| 200 | 205 | -112 (6.9pF) | 0.592 | -91 |
| EN = Low (Chip Disabled) | | | | |
| 1 | 1.96k | -20.1k (7.6pF) | 0.903 | -0.6 |
| 10 | 1.92k | -2.08k (7.6pF) | 0.901 | -5.5 |
| 20 | 1.8k | -1.05k (7.5pF) | 0.895 | -11 |
| 40 | 1.46k | -530 (8.9pF) | 0.876 | -21 |
| 100 | 639 | -218 (8.3pF) | 0.772 | -50 |
| 200 | 260 | -126 (6.1pF) | 0.629 | -82 |

*Parallel Equivalent

In Table 3 the common-mode S-parameters of the differential baseband inputs are given. The circuit is optimized for a common mode voltage of 1.4V which can be internally or externally applied. In case of AC-coupling to the baseband pins (1.4V internally generated bias) make sure that the high pass filter corner is not affecting the low frequency components of the baseband signal. Even a small error for low baseband frequencies can result in degraded EVM.

The baseband input offset voltage depends on the source resistance. In case of AC-coupling the 1 sigma offset is about 1.7mV, resulting in about -43.7dBm LO leakage. For shorted baseband pins (0 Ω source resistance), the LO leakage improves to about -45.6dBm. In case of AC-coupling the LO leakage can be reduced by connecting a resistor in parallel with the baseband inputs, thus

APPLICATIONS INFORMATION

Table 3. Common-Mode Baseband (BB) Input Impedance vs Frequency for EN = High and $V_{CMBB} = 1.4V$

| BB FREQUENCY (MHz) | INPUT IMPEDANCE (Ω) | | REFL COEFFICIENT | |
|--|------------------------------|-----------------|------------------|----------|
| | REAL* | IMAG* (CAP) | MAG | ANGLE(°) |
| LO FREQUENCY = 0.8GHz (REG. 0x00 = 0x70), DIGITAL GAIN = -4dB | | | | |
| 1 | 536 | -5.82k (25pF) | 0.911 | -0.5 |
| 10 | 534 | -605 (24.9pF) | 0.911 | -4.7 |
| 20 | 541 | -301 (25pF) | 0.912 | -9.5 |
| 40 | 447 | -145 (26pF) | 0.897 | -20 |
| 100 | 165 | -61 (24.2pF) | 0.771 | -46 |
| LO FREQUENCY = 1.8GHz (REG. 0x00 = 0x4B), DIGITAL GAIN = -4dB | | | | |
| 1 | 536 | -8.71k (16.8pF) | 0.911 | -0.3 |
| 10 | 547 | -907 (16.6pF) | 0.913 | -3.2 |
| 20 | 599 | -445 (16.9pF) | 0.920 | -6.4 |
| 40 | 620 | -203 (18.7pF) | 0.924 | -14 |
| 100 | 322 | -78 (18.9pF) | 0.869 | -36 |
| 200 | 135 | -41 (18.1pF) | 0.764 | -64 |
| LO FREQUENCY = 2.5GHz (REG. 0x00 = 0x3F), DIGITAL GAIN = -4dB | | | | |
| 1 | 537 | -9.76k (15pF) | 0.911 | -0.3 |
| 10 | 550 | -1.02k (14.8pF) | 0.913 | -2.8 |
| 20 | 609 | -496 (15.2pF) | 0.921 | -5.8 |
| 40 | 654 | -223 (17pF) | 0.927 | -13 |
| 100 | 380 | -84 (17.4pF) | 0.886 | -33 |
| 200 | 167 | -43 (17pF) | 0.799 | -61 |
| 400 | 55 | -22 (16.6pF) | 0.697 | -102 |
| LO FREQUENCY = 3.8GHz (REG. 0x00 = 0x2B), DIGITAL GAIN = -4dB | | | | |
| 1 | 537 | -11.2k (13pF) | 0.911 | -0.3 |
| 10 | 551 | -1.17k (12.8pF) | 0.913 | -2.4 |
| 20 | 617 | -571 (13.1pF) | 0.922 | -5 |
| 40 | 685 | -252 (15pF) | 0.930 | -11.3 |
| 100 | 449 | -94 (15.6pF) | 0.901 | -30 |
| 200 | 217 | -48 (15.5pF) | 0.835 | -56 |
| 400 | 71 | -24 (15.7pF) | 0.722 | -97 |
| LO FREQUENCY = 5.8GHz (REG. 0x00 = 0x1A), DIGITAL GAIN = -4dB | | | | |
| 1 | 537 | -12.3k (11.9pF) | 0.911 | -0.2 |
| 10 | 552 | -1.28k (11.8pF) | 0.913 | -2.2 |
| 20 | 620 | -620 (12.2pF) | 0.923 | -4.6 |
| 40 | 698 | -271 (14pF) | 0.931 | -11 |
| 100 | 486 | -101 (14.6pF) | 0.908 | -28 |
| 200 | 249 | -51 (14.6pF) | 0.851 | -53 |
| 400 | 83 | -25 (14.9pF) | 0.745 | -93 |

Table 3. Common-Mode Baseband (BB) Input Impedance vs Frequency for EN = High and $V_{CMBB} = 1.4V$ (continued)

| BB FREQUENCY (MHz) | INPUT IMPEDANCE (Ω) | | REFL COEFFICIENT | |
|---|------------------------------|-----------------|------------------|----------|
| | REAL* | IMAG* (CAP) | MAG | ANGLE(°) |
| LO FREQUENCY = 1.8GHz (REG. 0x00 = 0x4B), DIGITAL GAIN = 0dB | | | | |
| 1 | 515 | -8.6k (17pF) | 0.907 | -0.3 |
| 10 | 523 | -895 (16.8pF) | 0.909 | -3.2 |
| 20 | 564 | -443 (17pF) | 0.915 | -6.5 |
| 40 | 587 | -203 (18.7pF) | 0.919 | -14 |
| 100 | 313 | -78 (18.9pF) | 0.865 | -36 |
| 200 | 133 | -41 (18.1pF) | 0.762 | -64 |
| LO FREQUENCY = 1.8GHz (REG. 0x00 = 0x4B), DIGITAL GAIN = -19dB | | | | |
| 1 | 569 | -8.94k (16.4pF) | 0.916 | -0.3 |
| 10 | 587 | -929 (16.2pF) | 0.918 | -3.1 |
| 20 | 663 | -447 (16.8pF) | 0.928 | -6.4 |
| 40 | 675 | -203 (18.7pF) | 0.930 | -14 |
| 100 | 337 | -78 (18.9pF) | 0.874 | -36 |
| 200 | 138 | -41 (18pF) | 0.768 | -64 |
| EN = Low (Chip Disabled) | | | | |
| 1 | 1.01k | -10.6k (14.2pF) | 0.952 | -0.3 |
| 10 | 1.07k | -1.08k (13.9pF) | 0.952 | -2.6 |
| 20 | 975 | -546 (13.8pF) | 0.950 | -5.2 |
| 40 | 898 | -275 (13.8pF) | 0.946 | -10 |
| 100 | 612 | -108 (13.6pF) | 0.925 | -26 |
| 200 | 314 | -54 (13.6pF) | 0.877 | -50 |

*Parallel Equivalent

lowering baseband input impedance and offset. Further, the low combined baseband input leakage current of 1.3nA in shutdown mode retains the voltage over the coupling capacitors, which helps to settle faster when the part is enabled again. It is recommended to drive the baseband inputs differentially to maintain the linearity. When a DAC is used as the signal source, a reconstruction filter should be placed between the DAC output and the LTC5589 baseband inputs to avoid aliasing.

Internal Gain Trim DACs

Four internal gain trim DACs (one for each baseband pin) are configured as 11-bit each. The usable DAC input value range is integer continuous from 64 to 2047 and 0 for shutdown. The DACs are not intended for baseband signal generation but for gain and offset setting only, because there are no reconstruction filters between the DACs and the mixer core, and there is only indirect access between

APPLICATIONS INFORMATION

the DAC values and the register settings. The following functions are implemented in this way:

- Coarse digital gain control with 1dB steps
- Fine digital gain control with 0.1dB steps
- Gain-temperature correction
- DC offset adjustment in the I-channel
- DC offset adjustment in the Q-channel
- I/Q gain balance control
- Disable Q-channel
- Continuous variable gain control

Coarse Digital Gain Control (DG) with 1dB Steps (Register 0x01)

Twenty digital gain positions 1dB apart are implemented by hardwiring a corresponding DAC code for all four DACs. The coarse digital gain is set by writing to the five least-significant bits in register 0x01, see Table 8 and 9. The gain is the highest for code 00000 (code 0 = 0dB, DG = 0) and the lowest for code 10011 (code 19 = -19dB, DG = -19). Note that the gain 0dB set by the digital gain control is not the same as the voltage gain of the part. The remaining 12 codes (decimal 20 to 31) are reserved.

The digital gain in dB equals minus the decimal value written into the 5 least-significant bits of the gain register. The formula relating the modulator gain G (in V/V) relative to the maximum conversion gain therefore equals:

$$G(V/V) = 10^{(DG/20)}$$

Fine Digital Gain Control (FDG) with 0.1dB Steps and Gain-Temperature Correction (Register 0x07)

Sixteen digital gain positions about 0.1dB apart can be set directly using the four least-significant bits in register 0x07 combined with bit 2 = 1 in register 0x08 (TEMPCORR = 1). For coarse digital gain settings code 9 and higher, some or more subsequent codes of the fine digital gain positions may be the same due to the limited resolution of the 11-bit DACs. The main purpose of these 0.1dB gain steps is to implement an automatic gain/temperature correction which can be activated by setting TEMPCORR = 0. In that case, the input of the fine digital gain control will

be the on-chip thermometer. The on-chip thermometer generates a 4-bit digital code with code 0 corresponding to -30°C and code 15 corresponding to 120°C and 10°C spacing between the codes. The on-chip thermometer output code can be updated continuous (by clearing TEMPUPDT, bit 7 in register 0x01, see Table 8) or can be updated by bringing the external pin TTCK from low to high (and setting TEMPUPDT = 1). In case of continuous update the code will be an asynchronous update whenever the temperature crosses a certain threshold (TempComp On). In some cases it is desired to prevent a gain update to happen in the middle of a data frame. In that case, the gain/temperature update can be synchronized using the TTCK pin for example at the beginning or end of a data frame. For TempComp OFF, TEMPUPDT is set to 1 while TTCK is not toggling, deactivating the temperature gain compensation. The on-chip temperature can be read back by reading register 0x1F (TEMP[3:0]). The decimal value of TEMP[3:0] is given by:

$$\text{TEMP}[3:0] = \text{round}(T/10) + 3$$

with T the actual on-chip temperature in °C. It's accuracy is about $\pm 10^\circ\text{C}$. TEMP[3:0] defaults to 7 after an EN low to high transition with TEMPUPDT = 1. Switching from TEMPUPDT = 0 to TEMPUPDT = 1, TEMP[3:0] indicates the temperature during the last time TTCK went from low to high. Note that the actual on-chip temperature cannot be read if TEMPCORR = 1 or when TEMPUPDT = 1 without toggling TTCK.

Analog Gain Control

The LTC5589 supports analog control of the conversion gain through a voltage applied to V_{CTRL} (pin 1). The gain can be controlled downward from the digital gain setting (DG) programmed in register 0x01. In order to minimize distortion in the RF output signal the AGCTRL bit (bit 6 in register 0x01) should be set to 1. If analog gain control is not used, V_{CTRL} should be connected to V_{CC} and AGCTRL set to 0; this saves about 2.5mA of supply current. The typical usable gain control range is from 0.9V to 3.3V. Setting V_{CTRL} to a voltage lower than V_{CC} with AGCTRL = 0 significantly impairs the linearity of the RF output signal and lowers the V_{CTRL} response time. A simplified schematic is shown in Figure 1.

APPLICATIONS INFORMATION

I/Q DC Offset Adjustment (Registers 0x02 and 0x03) and LO Leakage

Offsets in the I- and Q-channel translates into LO leakage at the RF port. This offset can either be caused by the I/Q modulator or, in case the baseband connections are DC-coupled, applied externally. Registers 0x02 and 0x03 (I-offset and Q-offset) can be set to cancel this offset and hence lower the LO leakage. To adjust the offset in the I-channel, the BBPI DAC is set to a (slightly) different value than the BBMI DAC, introducing an offset. These 8-bit registers defaults are 128 and represents 0 offset. The register value can be set from 1 to 255. The value 0 represents an unsupported code and should not be used. Since the input referred offset depends on the gain the input offset value (V_{OS}) can be calculated as:

$$V_{OS} = 1260 / ((3632 \cdot G) / (N_{OS} - 128) - (N_{OS} - 128) / (3632 \cdot G))$$

and $V_{OS} = 0$ for $N_{OS} = 128$. G represents the gain from Table 4.

Table 4. Coarse Digital Gain (DG) Register Settings.

| DG (dB) | G(V/V) | DEC | BINARY | HEX |
|---------|--------|-----|--------|------|
| 0 | 1.000 | 0 | 00000 | 0x00 |
| -1 | 0.891 | 1 | 00001 | 0x01 |
| -2 | 0.794 | 2 | 00010 | 0x02 |
| -3 | 0.708 | 3 | 00011 | 0x03 |
| -4 | 0.631 | 4 | 00100 | 0x04 |
| -5 | 0.562 | 5 | 00101 | 0x05 |
| -6 | 0.501 | 6 | 00110 | 0x06 |
| -7 | 0.447 | 7 | 00111 | 0x07 |
| -8 | 0.398 | 8 | 01000 | 0x08 |
| -9 | 0.355 | 9 | 01001 | 0x09 |
| -10 | 0.316 | 10 | 01010 | 0x0A |
| -11 | 0.282 | 11 | 01011 | 0x0B |
| -12 | 0.251 | 12 | 01100 | 0x0C |
| -13 | 0.224 | 13 | 01101 | 0x0D |
| -14 | 0.200 | 14 | 01110 | 0x0E |
| -15 | 0.178 | 15 | 01111 | 0x0F |
| -16 | 0.158 | 16 | 10000 | 0x10 |
| -17 | 0.141 | 17 | 10001 | 0x11 |
| -18 | 0.126 | 18 | 10010 | 0x12 |
| -19 | 0.112 | 19 | 10011 | 0x13 |

A positive offset means that the voltage of the positive input terminal (BBPI or BBPQ) is increased relative to the negative input terminal (BBMI or BBMQ).

I/Q Gain Ratio (Register 0x04) and Side-Band Suppression

The 8-bit I/Q gain ratio register 0x04 controls the ratio of the I-channel mixer conversion gain G_I and the Q-channel mixer conversion gain G_Q . Together with the quadrature phase imbalance register 0x05, register 0x04 allows further optimization of the modulator side-band suppression.

The expression relating the gain ratio G_I/G_Q to the contents of the 8-bit register 0x04, represented by decimal N_{IQ} and the nominal conversion gain G equals:

$$20 \log (G_I/G_Q) = 20 \log ((3632 \cdot G - (N_{IQ} - 128)) / (3632 \cdot G + (N_{IQ} - 128))) \text{ (dB)}$$

The step size of the gain ratio trim in dB vs N_{IQ} is approximately constant for the same digital gain setting. For digital gain setting = -4, for example, the step size is about 7.6m dB. Table 5 lists the gain step size for each digital gain setting that follows from the formula above.

Table 5. I/Q Gain Ratio Step Size vs Digital Gain Setting

| DG (dB) | G (V/V) | $\Delta G_I/G_Q$ (m dB) |
|---------|---------|-------------------------|
| 0 | 1.000 | 4.8 |
| -1 | 0.891 | 5.4 |
| -2 | 0.794 | 6.0 |
| -3 | 0.708 | 6.8 |
| -4 | 0.631 | 7.6 |
| -5 | 0.562 | 8.5 |
| -6 | 0.501 | 9.6 |
| -7 | 0.447 | 10.7 |
| -8 | 0.398 | 12.0 |
| -9 | 0.355 | 13.5 |
| -10 | 0.316 | 15.1 |
| -11 | 0.282 | 17.1 |
| -12 | 0.251 | 19.2 |
| -13 | 0.224 | 21.5 |
| -14 | 0.200 | 24.2 |
| -15 | 0.178 | 27.3 |
| -16 | 0.158 | 30.7 |
| -17 | 0.141 | 34.6 |
| -18 | 0.126 | 39.0 |
| -19 | 0.112 | 44.1 |

APPLICATIONS INFORMATION

The conversion gain of the I-channel and Q-channel are equal for $N_{IQ} = 128$. The I-channel gain is larger than the Q-channel gain for $N_{IQ} > 128$.

Disable Q-Channel

If bit 5 in register 0x01 (QDISABLE) is set, the Q-channel is switched off, turning the I/Q modulator into an upconversion mixer. It is recommended to float the BBPQ and BBMQ pins in this mode. The default mode is Q-channel on (QDISABLE = 0).

LO Section (Register 0x00)

The internal LO chain consists of a polyphase filter which generates the I and Q signals for the image-reject double-balanced mixer. The center frequency of the polyphase filter is set by the lower seven bits of register 0x00. The recommended settings vs LO frequency are given in Table 6 (see the QuikEval™ GUI).

Table 6. Register 0x00 Setting vs LO Frequency

| REGISTER VALUE | | | LO FREQUENCY RANGE (MHz) | |
|----------------|---------|-----|--------------------------|-------------|
| DECIMAL | BINARY | HEX | LOWER BOUND | UPPER BOUND |
| 0 | 0000000 | 00 | N/A | N/A |
| 1 | 0000001 | 01 | N/A | N/A |
| 2 | 0000010 | 02 | N/A | N/A |
| 3 | 0000011 | 03 | N/A | N/A |
| 4 | 0000100 | 04 | 9204 | N/A |
| 5 | 0000101 | 05 | 9015 | 9204 |
| 6 | 0000110 | 06 | 8829 | 9015 |
| 7 | 0000111 | 07 | 8648 | 8829 |
| 8 | 0001000 | 08 | 8470 | 8648 |
| 9 | 0001001 | 09 | 8295 | 8470 |
| 10 | 0001010 | 0A | 8125 | 8295 |
| 11 | 0001011 | 0B | 7958 | 8125 |
| 12 | 0001100 | 0C | 7794 | 7958 |
| 13 | 0001101 | 0D | 7634 | 7794 |
| 14 | 0001110 | 0E | 7477 | 7634 |
| 15 | 0001111 | 0F | 7323 | 7477 |
| 16 | 0010000 | 10 | 7172 | 7323 |
| 17 | 0010001 | 11 | 7025 | 7172 |
| 18 | 0010010 | 12 | 6880 | 7025 |
| 19 | 0010011 | 13 | 6739 | 6880 |
| 20 | 0010100 | 14 | 6600 | 6739 |
| 21 | 0010101 | 15 | 6464 | 6600 |

Table 6. Register 0x00 Setting vs LO Frequency (continued)

| REGISTER VALUE | | | LO FREQUENCY RANGE (MHz) | |
|----------------|---------|-----|--------------------------|-------------|
| DECIMAL | BINARY | HEX | LOWER BOUND | UPPER BOUND |
| 22 | 0010110 | 16 | 6332 | 6464 |
| 23 | 0010111 | 17 | 6201 | 6332 |
| 24 | 0011000 | 18 | 6074 | 6201 |
| 25 | 0011001 | 19 | 5862 | 6074 |
| 26 | 0011010 | 1A | 5768 | 5862 |
| 27 | 0011011 | 1B | 5622 | 5768 |
| 28 | 0011100 | 1C | 5556 | 5622 |
| 29 | 0011101 | 1D | 5223 | 5556 |
| 30 | 0011110 | 1E | 5167 | 5223 |
| 31 | 0011111 | 1F | 5031 | 5167 |
| 32 | 0100000 | 20 | 4951 | 5031 |
| 33 | 0100001 | 21 | 4789 | 4951 |
| 34 | 0100010 | 22 | 4725 | 4789 |
| 35 | 0100011 | 23 | 4618 | 4725 |
| 36 | 0100100 | 24 | 4439 | 4618 |
| 37 | 0100101 | 25 | 4260 | 4439 |
| 38 | 0100110 | 26 | 4178 | 4260 |
| 39 | 0100111 | 27 | 4092 | 4178 |
| 40 | 0101000 | 28 | 4008 | 4092 |
| 41 | 0101001 | 29 | 3926 | 4008 |
| 42 | 0101010 | 2A | 3845 | 3926 |
| 43 | 0101011 | 2B | 3766 | 3845 |
| 44 | 0101100 | 2C | 3688 | 3766 |
| 45 | 0101101 | 2D | 3613 | 3688 |
| 46 | 0101110 | 2E | 3538 | 3613 |
| 47 | 0101111 | 2F | 3465 | 3538 |
| 48 | 0110000 | 30 | 3394 | 3465 |
| 49 | 0110001 | 31 | 3324 | 3394 |
| 50 | 0110010 | 32 | 3256 | 3324 |
| 51 | 0110011 | 33 | 3189 | 3256 |
| 52 | 0110100 | 34 | 3123 | 3189 |
| 53 | 0110101 | 35 | 3059 | 3123 |
| 54 | 0110110 | 36 | 2996 | 3059 |
| 55 | 0110111 | 37 | 2935 | 2996 |
| 56 | 0111000 | 38 | 2874 | 2935 |
| 57 | 0111001 | 39 | 2815 | 2874 |
| 58 | 0111010 | 3A | 2757 | 2815 |
| 59 | 0111011 | 3B | 2701 | 2757 |
| 60 | 0111100 | 3C | 2645 | 2701 |
| 61 | 0111101 | 3D | 2591 | 2645 |

APPLICATIONS INFORMATION

Table 6. Register 0x00 Setting vs LO Frequency (continued)

| REGISTER VALUE | | | LO FREQUENCY RANGE (MHz) | |
|----------------|---------|-----|--------------------------|-------------|
| DECIMAL | BINARY | HEX | LOWER BOUND | UPPER BOUND |
| 62 | 0111110 | 3E | 2537 | 2591 |
| 63 | 0111111 | 3F | 2485 | 2537 |
| 64 | 1000000 | 40 | 2434 | 2485 |
| 65 | 1000001 | 41 | 2384 | 2434 |
| 66 | 1000010 | 42 | 2335 | 2384 |
| 67 | 1000011 | 43 | 2287 | 2335 |
| 68 | 1000100 | 44 | 2240 | 2287 |
| 69 | 1000101 | 45 | 2194 | 2240 |
| 70 | 1000110 | 46 | 2149 | 2194 |
| 71 | 1000111 | 47 | 2104 | 2149 |
| 72 | 1001000 | 48 | 2061 | 2104 |
| 73 | 1001001 | 49 | 2019 | 2061 |
| 74 | 1001010 | 4A | 1818 | 2019 |
| 75 | 1001011 | 4B | 1710 | 1818 |
| 76 | 1001100 | 4C | 1590 | 1710 |
| 77 | 1001101 | 4D | 1506 | 1590 |
| 78 | 1001110 | 4E | 1479 | 1506 |
| 79 | 1001111 | 4F | 1453 | 1479 |
| 80 | 1010000 | 50 | 1427 | 1453 |
| 81 | 1010001 | 51 | 1402 | 1427 |
| 82 | 1010010 | 52 | 1377 | 1402 |
| 83 | 1010011 | 53 | 1353 | 1377 |
| 84 | 1010100 | 54 | 1329 | 1353 |
| 85 | 1010101 | 55 | 1305 | 1329 |
| 86 | 1010110 | 56 | 1282 | 1305 |
| 87 | 1010111 | 57 | 1278 | 1282 |
| 88 | 1011000 | 58 | 1221 | 1278 |
| 89 | 1011001 | 59 | 1160 | 1221 |
| 90 | 1011010 | 5A | 1143 | 1160 |
| 91 | 1011011 | 5B | 1140 | 1143 |
| 92 | 1011100 | 5C | 1116 | 1140 |
| 93 | 1011101 | 5D | 1088 | 1116 |
| 94 | 1011110 | 5E | 1085 | 1088 |
| 95 | 1011111 | 5F | 1079 | 1085 |
| 96 | 1100000 | 60 | 1062 | 1079 |
| 97 | 1100001 | 61 | 1037 | 1062 |
| 98 | 1100010 | 62 | 1030 | 1037 |
| 99 | 1100011 | 63 | 1017 | 1030 |
| 100 | 1100100 | 64 | 999 | 1017 |
| 101 | 1100101 | 65 | 981 | 999 |
| 102 | 1100110 | 66 | 964 | 981 |

Table 6. Register 0x00 Setting vs LO Frequency (continued)

| REGISTER VALUE | | | LO FREQUENCY RANGE (MHz) | |
|----------------|---------|-----|--------------------------|-------------|
| DECIMAL | BINARY | HEX | LOWER BOUND | UPPER BOUND |
| 103 | 1100111 | 67 | 947 | 964 |
| 104 | 1101000 | 68 | 930 | 947 |
| 105 | 1101001 | 69 | 914 | 930 |
| 106 | 1101010 | 6A | 897 | 914 |
| 107 | 1101011 | 6B | 880 | 897 |
| 108 | 1101100 | 6C | 860 | 880 |
| 109 | 1101101 | 6D | 849 | 860 |
| 110 | 1101110 | 6E | 829 | 849 |
| 111 | 1101111 | 6F | 810 | 829 |
| 112 | 1110000 | 70 | 792 | 810 |
| 113 | 1110001 | 71 | 774 | 792 |
| 114 | 1110010 | 72 | 757 | 774 |
| 115 | 1110011 | 73 | 741 | 757 |
| 116 | 1110100 | 74 | 726 | 741 |
| 117 | 1110101 | 75 | 712 | 726 |
| 118 | 1110110 | 76 | 699 | 712 |
| 119 | 1110111 | 77 | 687 | 699 |
| 120 | 1111000 | 78 | 675 | 687 |
| 121 | 1111001 | 79 | 663 | 675 |
| 122 | 1111010 | 7A | 651 | 663 |
| 123 | 1111011 | 7B | 639 | 651 |
| 124 | 1111100 | 7C | 628 | 639 |
| 125 | 1111101 | 7D | 618 | 628 |
| 126 | 1111110 | 7E | 609 | 618 |
| 127 | 1111111 | 7F | N/A | 609 |

A simplified circuit schematic of the LOL and LOC interfaces is depicted in Figure 2. The LOL and LOC inputs are not differential LO inputs. They are 50Ω inputs and are intended to be driven with an inductor going to the LOL input and a capacitor to the LOC input. Do not interchange the capacitor and inductor, as this will result in very poor performance.

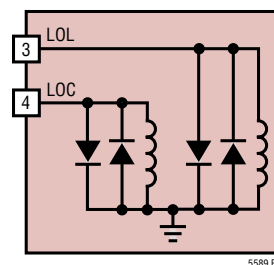

Figure 2. Simplified Circuit Schematic for the LOL and LOC Inputs

APPLICATIONS INFORMATION

For a wideband LO range an inductor value of 4.7nH and a capacitor value of 2pF (standard LO match, L1 and C5, see Fig. 12) is recommended at these pins, forming a diplexer circuit with center frequency of 1.4GHz. This diplexer helps to improve the uncalibrated side-band suppression significantly around 1.4GHz. Even for LO frequencies far from 1.4GHz the diplexer performs better than a single-ended LO drive or a differential drive. A 0.2pF capacitor is added in front of the diplexer in order to improve the high-frequency LO return loss (C18). Above 3.5GHz it is recommended to use the 5.8GHz LO Match (L1 = 0.8nH, C5 = 0.4pF, C18 = 0.1pF) This will improve return loss, side-band suppression, gain, OIP2 and OIP3 at higher LO frequencies. Due to factory calibration of the polyphase filter the typical side-band suppression is about 45dBc for frequencies from 700MHz to 4.2GHz using standard match and 30dBc from 4.2GHz to 6GHz using 5.8GHz LO Match. An adjustment of table 6 is recommended below 3.5GHz in case wide-band performance up to 6GHz is required. Using the 5.8GHz LO match changes the optimum register 0x00 settings below 3.5GHz compared using the standard LO match. Optimization shows good side-band suppression performance from 850MHz up to 6GHz using 5.8GHz LO match.

Vector Modulator

The LTC5589 can be used as a vector modulator by applying an RF signal to the LO port and obtaining a phase/gain modified signal at the RF output. The phase and gain can be set by DC values at the baseband inputs in combination with the settings of registers 0x00 to 0x08. For best performance it is recommended to design the LO input diplexer components L1, C5 and C18 to match the RF input signal frequency. The values for L1 and C5 are approximately:

$$L1 = 50 / (2\pi f_{RF})$$

$$C5 = 1 / (100\pi f_{RF})$$

I/Q Phase Balance Adjustment Register 0x05 and Side-Band Suppression

Ideally the I-channel LO phase is exactly 90° ahead of the Q-channel LO phase, so called quadrature. In practice however, the I/Q phase difference differs from exact quadrature by a small error due to component parameter variations and harmonic content in the LO signal (see below).

The I/Q phase imbalance register (0x05) allows adjustment of the I/Q phase shift to compensate for such errors. Together with gain ratio register 0x04, it can thus be used to optimize the side-band suppression of the modulator.

Register 0x05 contains two parts (see Table 8); the five least significant bits IQPHF realize a fine phase adjustment, while the three most significant bits IQPHE are used for coarse adjustments. The fine phase adjustment realized by IQPHF can be approximated as:

$$\phi_{IQ} = -((N_{ph} - 16) / 15)$$

where N_{ph} is the decimal value of IQPHF. A positive value for ϕ_{IQ} means that the I-channel LO phase is more than 90° ahead of the Q-channel LO phase. The extension bits IQPHE provide a larger phase adjustment range.

The extension bits IQPHE introduce a large phase offset in addition to the fine adjustment realized by the IQPHF bits. The sign of this large offset can be positive or negative, controlled by IQPHSIGN (bit 7 in register 0x00). Including these bits, the total phase shift from quadrature can be expressed as:

$$\phi_{IQ} = -(M_{PH} / 15) \text{ (degrees) with}$$

$$M_{PH} = N_{COARSE} + N_{PH} - 16 \text{ and}$$

$$N_{COARSE} = 32 \cdot (-1)^{IQPHSIGN + 1} \cdot N_{EXT}$$

where N_{ext} equals the decimal value of the IQPHE bits. The valid range of values for $(N_{ph} - 16)$ is thus expanded from $\{-16, -15, \dots, +15\}$ to $\{-240, -239, \dots, +239\}$. Table 7 in the Appendix lists all the possible combinations. The coding ranges for IQPHSIGN = 0 and IQPHSIGN = 1 overlap between $M_{ph} = -16$ and $M_{ph} = +15$, such that IQPHSIGN only needs to be changed for larger phase shifts.

APPLICATIONS INFORMATION

As a side effect, the extension bits slightly detune the center frequency of the polyphase filter, after crossing the boundary to a new N_{COARSE} value. This can be observed as a large step in the actual phase shift. A solution for this is to decrease the value in the frequency register 0x00 (increase the polyphase filter center frequency) at the N_{COARSE} value boundaries. The result is a smooth phase adjustment.

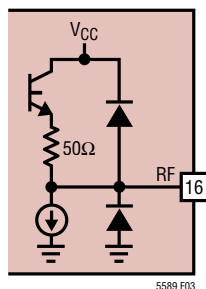

Figure 3. Simplified Circuit Schematic for the RF Output Port

Whenever the polyphase filter center frequency is adjusted to improve the smoothness of the phase adjustment, it is recommended to manually program the LO port impedance match using the CLOO bits in register 0x06. By default, changing the filter center frequency also automatically adjusts the matching of the LO port (when CLOEN, bit 4 in register 0x06 is set). However, since the LO carrier frequency does not change, automatic adjustment of the LO match is undesirable in this case; it may add another large step to the phase adjustment. Instead, the LO match should remain unchanged while the filter center frequency is adjusted. This can be achieved as follows. First, the current LO matching configuration is read from the CLO bits in register 0x1D, and written to the CLOO override bits in register 0x06. Subsequently, the CLOEN bit (bit 4, register 0x06) is cleared to disable automatic LO match adjustment. As a result the center frequency can be adjusted in register 0x00 without changing the LO match.

At 700MHz the maximum phase shift is about $\pm 0.15^\circ$, while at 800MHz it improves to about $\pm 5.8^\circ$. At 6GHz the maximum phase shift is about $\pm 6.7^\circ$ and a phase adjust-

ment causes considerable gain imbalance as a side effect. Iterative adjustment of I/Q gain and phase is required for optimum side-band suppression.

Square Wave LO Drive

Harmonic content of the LO signal adversely affects quadrature phase error and gain accuracy, whenever a polyphase filter is used for quadrature generation. The LTC5589 can correct for phase and gain errors due to harmonics in the LO carrier (e.g. in a square wave) by setting appropriate values in the I/Q gain and I/Q phase registers. Such adjustments are typically needed when the 3rd-order harmonic of the LO signal exceeds the desirable side-band suppression minus 17dB. Although the polyphase filter is less sensitive to the second harmonic content of the LO carrier, its influence can still be significant. For -35dBc second harmonic content, the side-band suppression can degrade to -60dBc ; for -28dBc it is -40dBc , assuming no I/Q gain and phase adjustments are made.

RF Output

After upconversion, the RF outputs of the I and Q mixers are combined. An on-chip buffer performs internal differential to single-ended conversion, while transforming the output signal to 50Ω as shown in Figure 3.

The RF port return loss vs frequency and digital gain setting for EN = High and EN = Low is given in the typical performance characteristics section.

For $V_{\text{CC}} = 3.3\text{V}$ and EN = High the RF pin DC voltage is about 1.77V. For $V_{\text{CC}} = 3.3\text{V}$ and EN = Low the RF pin DC voltage is about 3.1V.

Enable Interface

Figure 4 shows a simplified schematic of the EN pin interface. The voltage necessary to turn on the LTC5589 is 1.1V. To disable (shut down) the chip, the enable voltage must be below 0.2V.

APPLICATIONS INFORMATION

SERIAL PORT

The SPI-compatible serial port provides control and monitoring functionality.

Communication Sequence

The serial bus is comprised of CSB, SCLK, SDI and SDO. Data transfers to the part are accomplished by the serial bus master device first taking CSB low to enable the LTC5589's port. Input data applied on SDI is clocked on the rising edge of SCLK, with all transfers MSB first. The communication burst is terminated by the serial bus master returning CSB high. See Figure 5 for details.

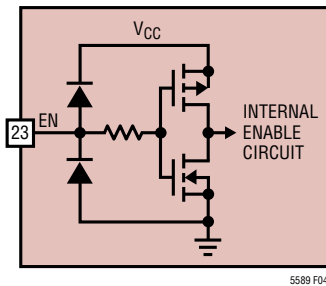

Figure 4. Simplified Circuit Schematic of the EN interface

Data is read from the part during a communication burst using SDO. Readback may be multidrop (more than one

LTC5589 connected in parallel on the serial bus), as SDO is high impedance (Hi-Z) when CSB = 1, or when data is not being read from the part. *If the LTC5589 is not used in a multidrop configuration, or if the serial port master is not capable of setting the SDO line level between read sequences, it is recommended to attach a resistor between SDO and V_{CC_L} to ensure the line returns to V_{CC_L} during Hi-Z states. The resistor value should be large enough to ensure that the SDO output current does not exceed 10mA. See Figure 6 for details.*

Single Byte Transfers

The serial port is arranged as a simple memory map, with status and control available in 9 read/write and 23 read-only byte-wide registers. All data bursts are comprised of at least two bytes. The 7 most significant bits of the first byte are the register address, with an LSB of 1 indicating a read from the part, and LSB of 0 indicating a write to the part. The subsequent byte, or bytes, is data from/to the specified register address. See Figure 7 for an example of a detailed write sequence, and Figure 8 for a read sequence.

Figure 9 shows an example of two write communication bursts. The first byte of the first burst sent from the serial bus master on SDI contains the destination register ad-

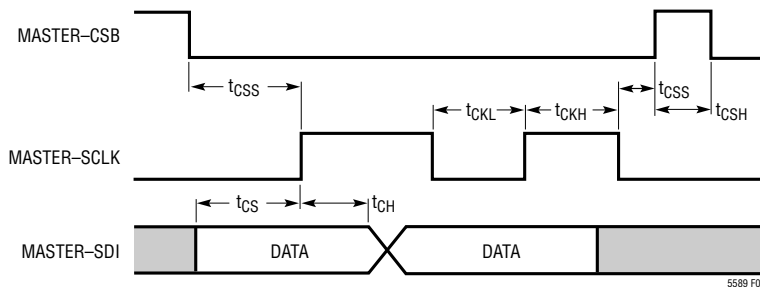

Figure 5. Serial Port Write Timing Diagram

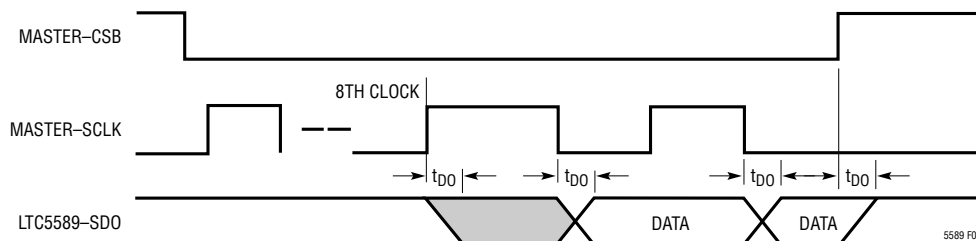

Figure 6. Serial Port Read Timing Diagram

APPLICATIONS INFORMATION

dress (Addr0) and an LSB of 0 indicating a write. The next byte is the data intended for the register at address Addr0. CSB is then taken high to terminate the transfer. The first byte of the second burst contains the destination register address (Addr1) and an LSB indicating a write. The next byte on SDI is the data intended for the register at address Addr1. CSB is then taken high to terminate the transfer.

Note that the written data is transferred to the internal register at the falling edge of the 16th clock cycle (parallel load).

Multiple Byte Transfers

More efficient data transfer of multiple bytes is accomplished by using the LTC5589's register address auto-increment feature as shown in Figure 10. The serial port master sends the destination register address in the first byte and its data in the second byte as before, but continues sending bytes destined for subsequent registers. Byte 1's address is Addr0+1, Byte 2's address is Addr0+2, and so on. If the register address pointer attempts to increment past 31 (0x1F), it is automatically reset to 0.

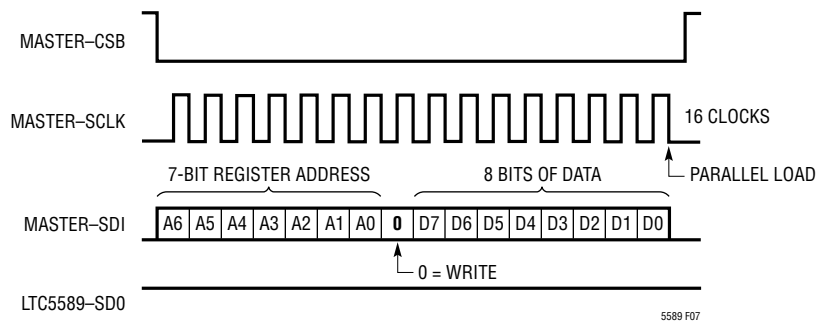

Figure 7. Serial Port Write Sequence

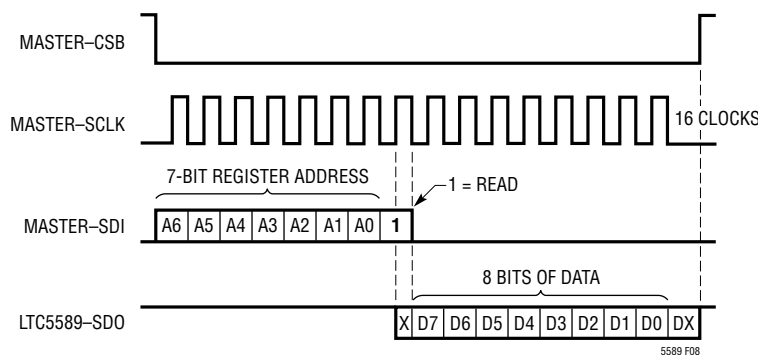

Figure 8. Serial Port Read Sequence

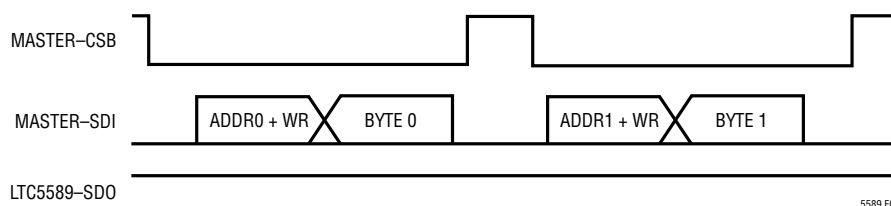

Figure 9. Serial Port Single Byte Writes

APPLICATIONS INFORMATION

An example of an auto-increment read from the part is shown in Figure 11. The first byte of the burst sent from the serial bus master on SDI contains the destination register address (Addr0) and an LSB of 1 indicating a read. Once the LTC5589 detects a read burst, it takes SDO out of the Hi-Z condition and sends data bytes sequentially, beginning with data from register Addr0. The part ignores all other data on SDI until the end of the burst.

Multidrop Configuration

Several LTC5589s may share the serial bus. In this multidrop configuration, SCLK, SDI, and SDO are common between all parts. The serial bus master must use a separate CSB for each LTC5589 and ensure that only one device has CSB asserted at any time. It is recommended to attach a high value resistor to SDO to ensure the line returns to a known level (V_{CC_L}) during Hi-Z states.

Serial Port Registers

The memory map of the LTC5589 may be found in the Appendix in Table 8, with detailed bit descriptions found in Table 9. The register address shown in hexadecimal format under the ADDR column is used to specify each register. Each register is denoted as either read-only (R) or read-write (R/W). The register's default value on device power-up or after a reset (bit 3, register 0x08, SRESET) is shown at the right.

SPI Signal Levels

The SPI bus supports signal levels from a digital V_{CC_L} from 1.2V to 3.6V. The CSB = 1.2V condition creates an additional static input sleep current of 0.2 μ A. For CSB = 1.8V or higher the extra sleep current can be neglected.

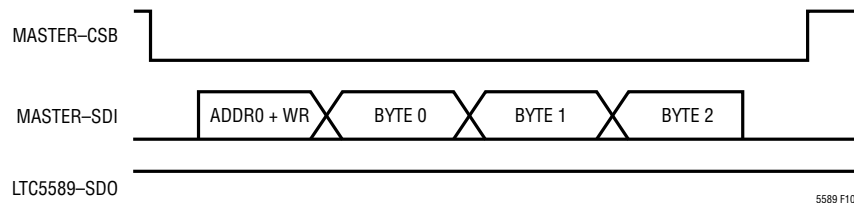

Figure 10. Serial Port Auto-Increment Write

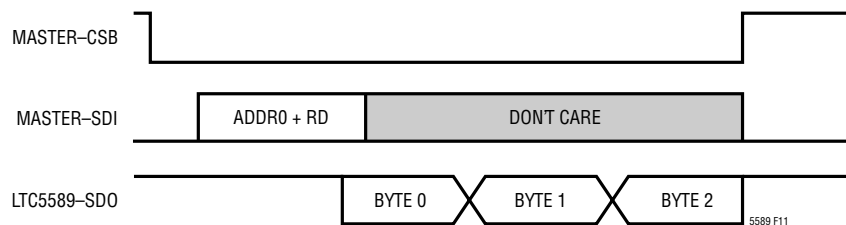

Figure 11. Serial Port Auto-Increment Read

APPLICATIONS INFORMATION

Evaluation Board

Figure 12 shows the evaluation board schematic. A good ground connection is required for the exposed pad. If this is not done properly, the RF performance will degrade. Figures 13 and 14 show the component side and bottom side of the evaluation board.

Ferrite bead FB1 limits the supply voltage ramping speed in case V_{CC} is abruptly connected to a voltage source.

In the application, limit the V_{CC} ramp speed to a maximum of $1V/\mu s$.

Baseband termination components C6 to C9 and R8 to R11 are not installed in the customer demo board to avoid a low frequency corner point in order to maintain EVM performance.

For better performance at frequencies above 3.5GHz, it is recommended to use $L1 = 0.8nH$, $C5 = 0.4pF$ and $C18 = 0.1pF$.

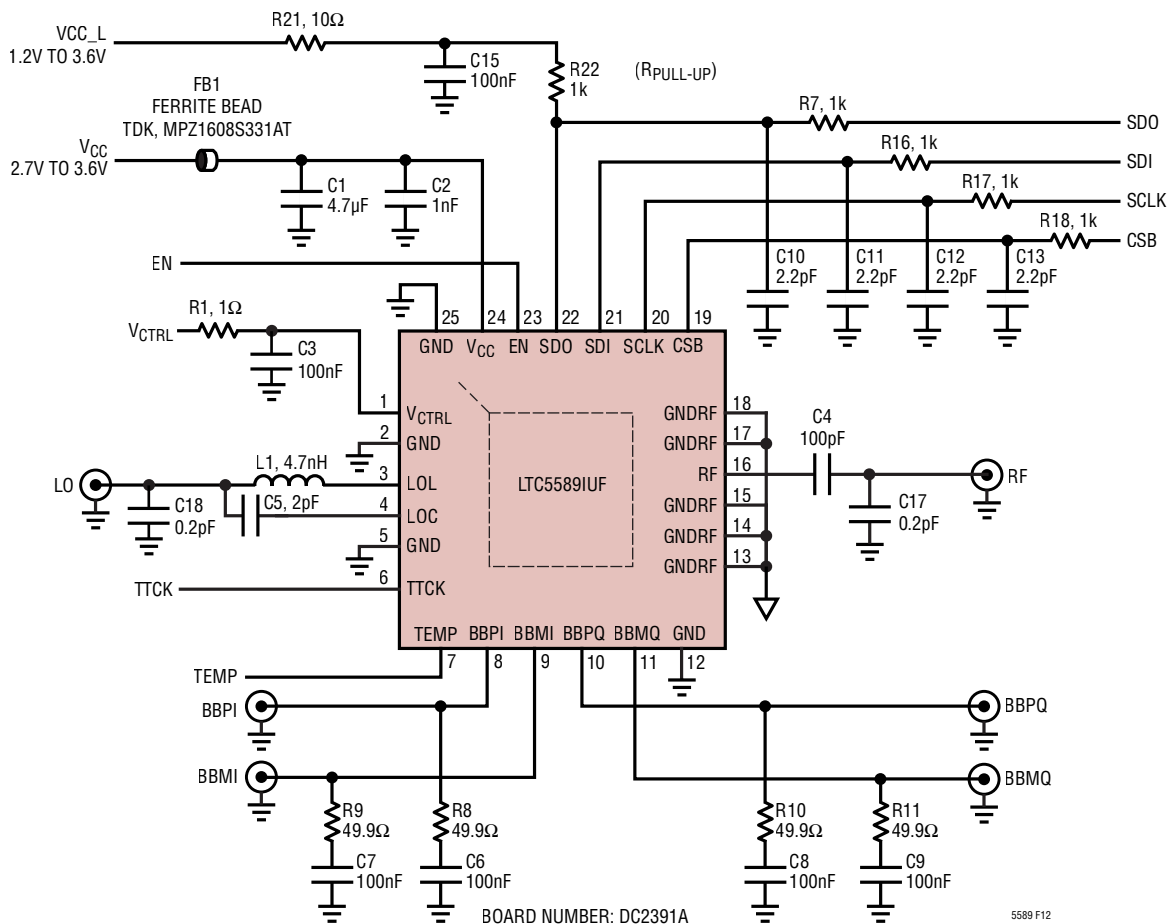

Figure 12. Test Circuit Schematic

APPLICATIONS INFORMATION

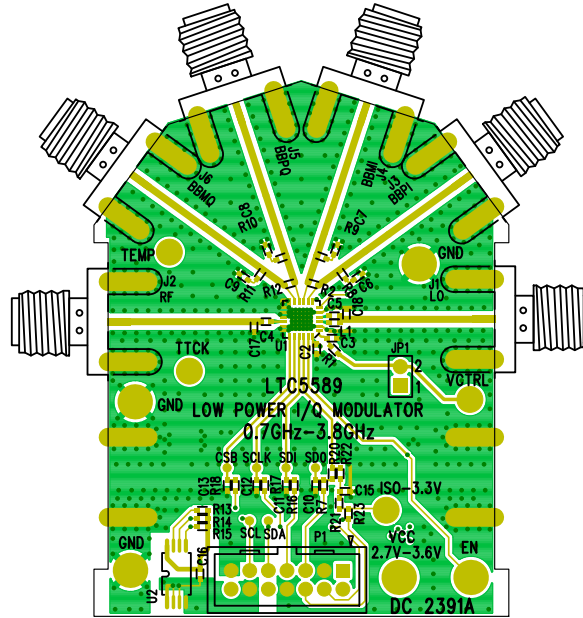

Figure 13. Evaluation Board Component Side

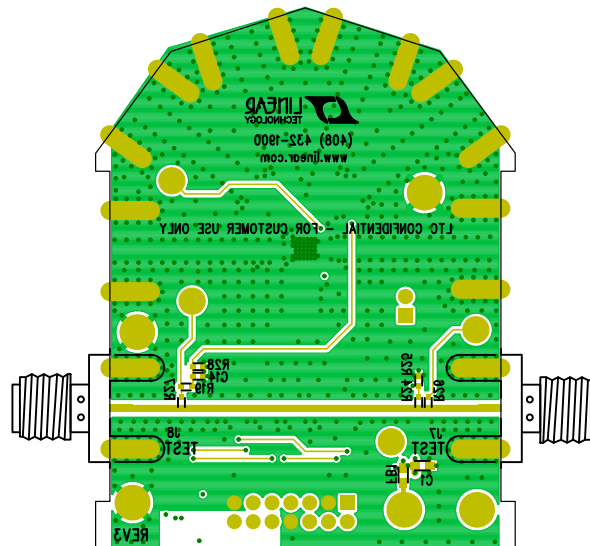

Figure 14. Evaluation Board Bottom Side

APPENDIX

Phase Shift Register (0x05) Map

This appendix summarizes the detailed value assignments for the phase shift register, including the extension bits and sign bit (bit 7 in register 0x00).

Table 7. Register 0x05 Phase Shift Register Settings, Including the Extension Bits and Sign Bit (Bit 7 in Register 0x00)

| M _{PH} | N _{COARSE} | N _{PH} | B _{PH} |
|-----------------|---------------------|-----------------|-----------------|
| -240 | -224 | 0 | 011100000 |
| -239 | -224 | 1 | 011100001 |
| -238 | -224 | 2 | 011100010 |
| -237 | -224 | 3 | 011100011 |
| -236 | -224 | 4 | 011100100 |
| -235 | -224 | 5 | 011100101 |
| -234 | -224 | 6 | 011100110 |
| -233 | -224 | 7 | 011100111 |
| -232 | -224 | 8 | 011101000 |
| -231 | -224 | 9 | 011101001 |
| -230 | -224 | 10 | 011101010 |
| -229 | -224 | 11 | 011101011 |
| -228 | -224 | 12 | 011101100 |
| -227 | -224 | 13 | 011101101 |
| -226 | -224 | 14 | 011101110 |
| -225 | -224 | 15 | 011101111 |
| -224 | -224 | 16 | 011110000 |
| -223 | -224 | 17 | 011110001 |
| -222 | -224 | 18 | 011110010 |
| -221 | -224 | 19 | 011110011 |
| -220 | -224 | 20 | 011110100 |
| -219 | -224 | 21 | 011110101 |
| -218 | -224 | 22 | 011110110 |
| -217 | -224 | 23 | 011110111 |
| -216 | -224 | 24 | 011111000 |
| -215 | -224 | 25 | 011111001 |
| -214 | -224 | 26 | 011111010 |
| -213 | -224 | 27 | 011111011 |
| -212 | -224 | 28 | 011111100 |
| -211 | -224 | 29 | 011111101 |
| -210 | -224 | 30 | 011111110 |
| -209 | -224 | 31 | 011111111 |
| -208 | -192 | 0 | 011000000 |
| -207 | -192 | 1 | 011000001 |
| -206 | -192 | 2 | 011000010 |
| -205 | -192 | 3 | 011000011 |

Table 7. Register 0x05 Phase Shift Register Settings, Including the Extension Bits and Sign Bit (Bit 7 in Register 0x00) (continued)

| M _{PH} | N _{COARSE} | N _{PH} | B _{PH} |
|-----------------|---------------------|-----------------|-----------------|
| -204 | -192 | 4 | 011000100 |
| -203 | -192 | 5 | 011000101 |
| -202 | -192 | 6 | 011000110 |
| -201 | -192 | 7 | 011000111 |
| -200 | -192 | 8 | 011001000 |
| -199 | -192 | 9 | 011001001 |
| -198 | -192 | 10 | 011001010 |
| -197 | -192 | 11 | 011001011 |
| -196 | -192 | 12 | 011001100 |
| -195 | -192 | 13 | 011001101 |
| -194 | -192 | 14 | 011001110 |
| -193 | -192 | 15 | 011001111 |
| -192 | -192 | 16 | 011010000 |
| -191 | -192 | 17 | 011010001 |
| -190 | -192 | 18 | 011010010 |
| -189 | -192 | 19 | 011010011 |
| -188 | -192 | 20 | 011010100 |
| -187 | -192 | 21 | 011010101 |
| -186 | -192 | 22 | 011010110 |
| -185 | -192 | 23 | 011010111 |
| -184 | -192 | 24 | 011011000 |
| -183 | -192 | 25 | 011011001 |
| -182 | -192 | 26 | 011011010 |
| -181 | -192 | 27 | 011011011 |
| -180 | -192 | 28 | 011011100 |
| -179 | -192 | 29 | 011011101 |
| -178 | -192 | 30 | 011011110 |
| -177 | -192 | 31 | 011011111 |
| -176 | -160 | 0 | 010100000 |
| -175 | -160 | 1 | 010100001 |
| -174 | -160 | 2 | 010100010 |
| -173 | -160 | 3 | 010100011 |
| -172 | -160 | 4 | 010100100 |
| -171 | -160 | 5 | 010100101 |
| -170 | -160 | 6 | 010100110 |
| -169 | -160 | 7 | 010100111 |
| -168 | -160 | 8 | 010101000 |
| -167 | -160 | 9 | 010101001 |
| -166 | -160 | 10 | 010101010 |
| -165 | -160 | 11 | 010101011 |
| -164 | -160 | 12 | 010101100 |

APPENDIX

Table 7. Register 0x05 Phase Shift Register Settings, Including the Extension Bits and Sign Bit (Bit 7 in Register 0x00) (continued)

| M _{PH} | N _{COARSE} | N _{PH} | B _{PH} |
|-----------------|---------------------|-----------------|-----------------|
| -163 | -160 | 13 | 010101101 |
| -162 | -160 | 14 | 010101110 |
| -161 | -160 | 15 | 010101111 |
| -160 | -160 | 16 | 010110000 |
| -159 | -160 | 17 | 010110001 |
| -158 | -160 | 18 | 010110010 |
| -157 | -160 | 19 | 010110011 |
| -156 | -160 | 20 | 010110100 |
| -155 | -160 | 21 | 010110101 |
| -154 | -160 | 22 | 010110110 |
| -153 | -160 | 23 | 010110111 |
| -152 | -160 | 24 | 010111000 |
| -151 | -160 | 25 | 010111001 |
| -150 | -160 | 26 | 010111010 |
| -149 | -160 | 27 | 010111011 |
| -148 | -160 | 28 | 010111100 |
| -147 | -160 | 29 | 010111101 |
| -146 | -160 | 30 | 010111110 |
| -145 | -160 | 31 | 010111111 |
| -144 | -128 | 0 | 010000000 |
| -143 | -128 | 1 | 010000001 |
| -142 | -128 | 2 | 010000010 |
| -141 | -128 | 3 | 010000011 |
| -140 | -128 | 4 | 010000100 |
| -139 | -128 | 5 | 010000101 |
| -138 | -128 | 6 | 010000110 |
| -137 | -128 | 7 | 010000111 |
| -136 | -128 | 8 | 010001000 |
| -135 | -128 | 9 | 010001001 |
| -134 | -128 | 10 | 010001010 |
| -133 | -128 | 11 | 010001011 |
| -132 | -128 | 12 | 010001100 |
| -131 | -128 | 13 | 010001101 |
| -130 | -128 | 14 | 010001110 |
| -129 | -128 | 15 | 010001111 |
| -128 | -128 | 16 | 010010000 |
| -127 | -128 | 17 | 010010001 |
| -126 | -128 | 18 | 010010010 |
| -125 | -128 | 19 | 010010011 |
| -124 | -128 | 20 | 010010100 |
| -123 | -128 | 21 | 010010101 |

Table 7. Register 0x05 Phase Shift Register Settings, Including the Extension Bits and Sign Bit (Bit 7 in Register 0x00) (continued)

| M _{PH} | N _{COARSE} | N _{PH} | B _{PH} |
|-----------------|---------------------|-----------------|-----------------|
| -122 | -128 | 22 | 010010110 |
| -121 | -128 | 23 | 010010111 |
| -120 | -128 | 24 | 010011000 |
| -119 | -128 | 25 | 010011001 |
| -118 | -128 | 26 | 010011010 |
| -117 | -128 | 27 | 010011011 |
| -116 | -128 | 28 | 010011100 |
| -115 | -128 | 29 | 010011101 |
| -114 | -128 | 30 | 010011110 |
| -113 | -128 | 31 | 010011111 |
| -112 | -96 | 0 | 001100000 |
| -111 | -96 | 1 | 001100001 |
| -110 | -96 | 2 | 001100010 |
| -109 | -96 | 3 | 001100011 |
| -108 | -96 | 4 | 001100100 |
| -107 | -96 | 5 | 001100101 |
| -106 | -96 | 6 | 001100110 |
| -105 | -96 | 7 | 001100111 |
| -104 | -96 | 8 | 001101000 |
| -103 | -96 | 9 | 001101001 |
| -102 | -96 | 10 | 001101010 |
| -101 | -96 | 11 | 001101011 |
| -100 | -96 | 12 | 001101100 |
| -99 | -96 | 13 | 001101101 |
| -98 | -96 | 14 | 001101110 |
| -97 | -96 | 15 | 001101111 |
| -96 | -96 | 16 | 001110000 |
| -95 | -96 | 17 | 001110001 |
| -94 | -96 | 18 | 001110010 |
| -93 | -96 | 19 | 001110011 |
| -92 | -96 | 20 | 001110100 |
| -91 | -96 | 21 | 001110101 |
| -90 | -96 | 22 | 001110110 |
| -89 | -96 | 23 | 001110111 |
| -88 | -96 | 24 | 001111000 |
| -87 | -96 | 25 | 001111001 |
| -86 | -96 | 26 | 001111010 |
| -85 | -96 | 27 | 001111011 |
| -84 | -96 | 28 | 001111100 |
| -83 | -96 | 29 | 001111101 |
| -82 | -96 | 30 | 001111110 |

APPENDIX

Table 7. Register 0x05 Phase Shift Register Settings, Including the Extension Bits and Sign Bit (Bit 7 in Register 0x00) (continued)

| M _{PH} | N _{COARSE} | N _{PH} | B _{PH} |
|-----------------|---------------------|-----------------|-----------------|
| -81 | -96 | 31 | 001111111 |
| -80 | -64 | 0 | 001000000 |
| -79 | -64 | 1 | 001000001 |
| -78 | -64 | 2 | 001000010 |
| -77 | -64 | 3 | 001000011 |
| -76 | -64 | 4 | 001000100 |
| -75 | -64 | 5 | 001000101 |
| -74 | -64 | 6 | 001000110 |
| -73 | -64 | 7 | 001000111 |
| -72 | -64 | 8 | 001001000 |
| -71 | -64 | 9 | 001001001 |
| -70 | -64 | 10 | 001001010 |
| -69 | -64 | 11 | 001001011 |
| -68 | -64 | 12 | 001001100 |
| -67 | -64 | 13 | 001001101 |
| -66 | -64 | 14 | 001001110 |
| -65 | -64 | 15 | 001001111 |
| -64 | -64 | 16 | 001010000 |
| -63 | -64 | 17 | 001010001 |
| -62 | -64 | 18 | 001010010 |
| -61 | -64 | 19 | 001010011 |
| -60 | -64 | 20 | 001010100 |
| -59 | -64 | 21 | 001010101 |
| -58 | -64 | 22 | 001010110 |
| -57 | -64 | 23 | 001010111 |
| -56 | -64 | 24 | 001011000 |
| -55 | -64 | 25 | 001011001 |
| -54 | -64 | 26 | 001011010 |
| -53 | -64 | 27 | 001011011 |
| -52 | -64 | 28 | 001011100 |
| -51 | -64 | 29 | 001011101 |
| -50 | -64 | 30 | 001011110 |
| -49 | -64 | 31 | 001011111 |
| -48 | -32 | 0 | 000100000 |
| -47 | -32 | 1 | 000100001 |
| -46 | -32 | 2 | 000100010 |
| -45 | -32 | 3 | 000100011 |
| -44 | -32 | 4 | 000100100 |
| -43 | -32 | 5 | 000100101 |
| -42 | -32 | 6 | 000100110 |
| -41 | -32 | 7 | 000100111 |

Table 7. Register 0x05 Phase Shift Register Settings, Including the Extension Bits and Sign Bit (Bit 7 in Register 0x00) (continued)

| M _{PH} | N _{COARSE} | N _{PH} | B _{PH} |
|-----------------|---------------------|-----------------|-----------------|
| -40 | -32 | 8 | 000101000 |
| -39 | -32 | 9 | 000101001 |
| -38 | -32 | 10 | 000101010 |
| -37 | -32 | 11 | 000101011 |
| -36 | -32 | 12 | 000101100 |
| -35 | -32 | 13 | 000101101 |
| -34 | -32 | 14 | 000101110 |
| -33 | -32 | 15 | 000101111 |
| -32 | -32 | 16 | 000110000 |
| -31 | -32 | 17 | 000110001 |
| -30 | -32 | 18 | 000110010 |
| -29 | -32 | 19 | 000110011 |
| -28 | -32 | 20 | 000110100 |
| -27 | -32 | 21 | 000110101 |
| -26 | -32 | 22 | 000110110 |
| -25 | -32 | 23 | 000110111 |
| -24 | -32 | 24 | 000111000 |
| -23 | -32 | 25 | 000111001 |
| -22 | -32 | 26 | 000111010 |
| -21 | -32 | 27 | 000111011 |
| -20 | -32 | 28 | 000111100 |
| -19 | -32 | 29 | 000111101 |
| -18 | -32 | 30 | 000111110 |
| -17 | -32 | 31 | 000111111 |
| -16 | 0 | 0 | x00000000 |
| -15 | 0 | 1 | x00000001 |
| -14 | 0 | 2 | x00000010 |
| -13 | 0 | 3 | x00000011 |
| -12 | 0 | 4 | x00000100 |
| -11 | 0 | 5 | x00000101 |
| -10 | 0 | 6 | x00000110 |
| -9 | 0 | 7 | x00000111 |
| -8 | 0 | 8 | x00001000 |
| -7 | 0 | 9 | x00001001 |
| -6 | 0 | 10 | x00001010 |
| -5 | 0 | 11 | x00001011 |
| -4 | 0 | 12 | x00001100 |
| -3 | 0 | 13 | x00001101 |
| -2 | 0 | 14 | x00001110 |
| -1 | 0 | 15 | x00001111 |
| 0 | 0 | 16 | x00010000 |

APPENDIX

Table 7. Register 0x05 Phase Shift Register Settings, Including the Extension Bits and Sign Bit (Bit 7 in Register 0x00) (continued)

| M _{PH} | N _{COARSE} | N _{PH} | B _{PH} |
|-----------------|---------------------|-----------------|-----------------|
| 1 | 0 | 17 | x00010001 |
| 2 | 0 | 18 | x00010010 |
| 3 | 0 | 19 | x00010011 |
| 4 | 0 | 20 | x00010100 |
| 5 | 0 | 21 | x00010101 |
| 6 | 0 | 22 | x00010110 |
| 7 | 0 | 23 | x00010111 |
| 8 | 0 | 24 | x00011000 |
| 9 | 0 | 25 | x00011001 |
| 10 | 0 | 26 | x00011010 |
| 11 | 0 | 27 | x00011011 |
| 12 | 0 | 28 | x00011100 |
| 13 | 0 | 29 | x00011101 |
| 14 | 0 | 30 | x00011110 |
| 15 | 0 | 31 | x00011111 |
| 16 | 32 | 0 | 10010000 |
| 17 | 32 | 1 | 10010001 |
| 18 | 32 | 2 | 10010010 |
| 19 | 32 | 3 | 10010011 |
| 20 | 32 | 4 | 10010100 |
| 21 | 32 | 5 | 10010101 |
| 22 | 32 | 6 | 10010110 |
| 23 | 32 | 7 | 10010111 |
| 24 | 32 | 8 | 100101000 |
| 25 | 32 | 9 | 100101001 |
| 26 | 32 | 10 | 100101010 |
| 27 | 32 | 11 | 100101011 |
| 28 | 32 | 12 | 100101100 |
| 29 | 32 | 13 | 100101101 |
| 30 | 32 | 14 | 100101110 |
| 31 | 32 | 15 | 100101111 |
| 32 | 32 | 16 | 100110000 |
| 33 | 32 | 17 | 100110001 |
| 34 | 32 | 18 | 100110010 |
| 35 | 32 | 19 | 100110011 |
| 36 | 32 | 20 | 100110100 |
| 37 | 32 | 21 | 100110101 |
| 38 | 32 | 22 | 100110110 |
| 39 | 32 | 23 | 100110111 |
| 40 | 32 | 24 | 100111000 |
| 41 | 32 | 25 | 100111001 |

Table 7. Register 0x05 Phase Shift Register Settings, Including the Extension Bits and Sign Bit (Bit 7 in Register 0x00) (continued)

| M _{PH} | N _{COARSE} | N _{PH} | B _{PH} |
|-----------------|---------------------|-----------------|-----------------|
| 42 | 32 | 26 | 100111010 |
| 43 | 32 | 27 | 100111011 |
| 44 | 32 | 28 | 100111100 |
| 45 | 32 | 29 | 100111101 |
| 46 | 32 | 30 | 100111110 |
| 47 | 32 | 31 | 100111111 |
| 48 | 64 | 0 | 101000000 |
| 49 | 64 | 1 | 101000001 |
| 50 | 64 | 2 | 101000010 |
| 51 | 64 | 3 | 101000011 |
| 52 | 64 | 4 | 101000100 |
| 53 | 64 | 5 | 101000101 |
| 54 | 64 | 6 | 101000110 |
| 55 | 64 | 7 | 101000111 |
| 56 | 64 | 8 | 101001000 |
| 57 | 64 | 9 | 101001001 |
| 58 | 64 | 10 | 101001010 |
| 59 | 64 | 11 | 101001011 |
| 60 | 64 | 12 | 101001100 |
| 61 | 64 | 13 | 101001101 |
| 62 | 64 | 14 | 101001110 |
| 63 | 64 | 15 | 101001111 |
| 64 | 64 | 16 | 101010000 |
| 65 | 64 | 17 | 101010001 |
| 66 | 64 | 18 | 101010010 |
| 67 | 64 | 19 | 101010011 |
| 68 | 64 | 20 | 101010100 |
| 69 | 64 | 21 | 101010101 |
| 70 | 64 | 22 | 101010110 |
| 71 | 64 | 23 | 101010111 |
| 72 | 64 | 24 | 101011000 |
| 73 | 64 | 25 | 101011001 |
| 74 | 64 | 26 | 101011010 |
| 75 | 64 | 27 | 101011011 |
| 76 | 64 | 28 | 101011100 |
| 77 | 64 | 29 | 101011101 |
| 78 | 64 | 30 | 101011110 |
| 79 | 64 | 31 | 101011111 |
| 80 | 96 | 0 | 101100000 |
| 81 | 96 | 1 | 101100001 |
| 82 | 96 | 2 | 101100010 |

APPENDIX

Table 7. Register 0x05 Phase Shift Register Settings, Including the Extension Bits and Sign Bit (Bit 7 in Register 0x00) (continued)

| M _{PH} | N _{COARSE} | N _{PH} | B _{PH} |
|-----------------|---------------------|-----------------|-----------------|
| 83 | 96 | 3 | 101100011 |
| 84 | 96 | 4 | 101100100 |
| 85 | 96 | 5 | 101100101 |
| 86 | 96 | 6 | 101100110 |
| 87 | 96 | 7 | 101100111 |
| 88 | 96 | 8 | 101101000 |
| 89 | 96 | 9 | 101101001 |
| 90 | 96 | 10 | 101101010 |
| 91 | 96 | 11 | 101101011 |
| 92 | 96 | 12 | 101101100 |
| 93 | 96 | 13 | 101101101 |
| 94 | 96 | 14 | 101101110 |
| 95 | 96 | 15 | 101101111 |
| 96 | 96 | 16 | 101110000 |
| 97 | 96 | 17 | 101110001 |
| 98 | 96 | 18 | 101110010 |
| 99 | 96 | 19 | 101110011 |
| 100 | 96 | 20 | 101110100 |
| 101 | 96 | 21 | 101110101 |
| 102 | 96 | 22 | 101110110 |
| 103 | 96 | 23 | 101110111 |
| 104 | 96 | 24 | 101111000 |
| 105 | 96 | 25 | 101111001 |
| 106 | 96 | 26 | 101111010 |
| 107 | 96 | 27 | 101111011 |
| 108 | 96 | 28 | 101111100 |
| 109 | 96 | 29 | 101111101 |
| 110 | 96 | 30 | 101111110 |
| 111 | 96 | 31 | 101111111 |
| 112 | 128 | 0 | 110000000 |
| 113 | 128 | 1 | 110000001 |
| 114 | 128 | 2 | 110000010 |
| 115 | 128 | 3 | 110000011 |
| 116 | 128 | 4 | 110000100 |
| 117 | 128 | 5 | 110000101 |
| 118 | 128 | 6 | 110000110 |
| 119 | 128 | 7 | 110000111 |
| 120 | 128 | 8 | 110001000 |
| 121 | 128 | 9 | 110001001 |
| 122 | 128 | 10 | 110001010 |
| 123 | 128 | 11 | 110001011 |

Table 7. Register 0x05 Phase Shift Register Settings, Including the Extension Bits and Sign Bit (Bit 7 in Register 0x00) (continued)

| M _{PH} | N _{COARSE} | N _{PH} | B _{PH} |
|-----------------|---------------------|-----------------|-----------------|
| 124 | 128 | 12 | 110001100 |
| 125 | 128 | 13 | 110001101 |
| 126 | 128 | 14 | 110001110 |
| 127 | 128 | 15 | 110001111 |
| 128 | 128 | 16 | 110010000 |
| 129 | 128 | 17 | 110010001 |
| 130 | 128 | 18 | 110010010 |
| 131 | 128 | 19 | 110010011 |
| 132 | 128 | 20 | 110010100 |
| 133 | 128 | 21 | 110010101 |
| 134 | 128 | 22 | 110010110 |
| 135 | 128 | 23 | 110010111 |
| 136 | 128 | 24 | 110011000 |
| 137 | 128 | 25 | 110011001 |
| 138 | 128 | 26 | 110011010 |
| 139 | 128 | 27 | 110011011 |
| 140 | 128 | 28 | 110011100 |
| 141 | 128 | 29 | 110011101 |
| 142 | 128 | 30 | 110011110 |
| 143 | 128 | 31 | 110011111 |
| 144 | 160 | 0 | 110100000 |
| 145 | 160 | 1 | 110100001 |
| 146 | 160 | 2 | 110100010 |
| 147 | 160 | 3 | 110100011 |
| 148 | 160 | 4 | 110100100 |
| 149 | 160 | 5 | 110100101 |
| 150 | 160 | 6 | 110100110 |
| 151 | 160 | 7 | 110100111 |
| 152 | 160 | 8 | 110101000 |
| 153 | 160 | 9 | 110101001 |
| 154 | 160 | 10 | 110101010 |
| 155 | 160 | 11 | 110101011 |
| 156 | 160 | 12 | 110101100 |
| 157 | 160 | 13 | 110101101 |
| 158 | 160 | 14 | 110101110 |
| 159 | 160 | 15 | 110101111 |
| 160 | 160 | 16 | 110110000 |
| 161 | 160 | 17 | 110110001 |
| 162 | 160 | 18 | 110110010 |
| 163 | 160 | 19 | 110110011 |
| 164 | 160 | 20 | 110110100 |

APPENDIX

Table 7. Register 0x05 Phase Shift Register Settings, Including the Extension Bits and Sign Bit (Bit 7 in Register 0x00) (continued)

| M _{PH} | N _{COARSE} | N _{PH} | B _{PH} |
|-----------------|---------------------|-----------------|-----------------|
| 165 | 160 | 21 | 110110101 |
| 166 | 160 | 22 | 110110110 |
| 167 | 160 | 23 | 110110111 |
| 168 | 160 | 24 | 110111000 |
| 169 | 160 | 25 | 110111001 |
| 170 | 160 | 26 | 110111010 |
| 171 | 160 | 27 | 110111011 |
| 172 | 160 | 28 | 110111100 |
| 173 | 160 | 29 | 110111101 |
| 174 | 160 | 30 | 110111110 |
| 175 | 160 | 31 | 110111111 |
| 176 | 192 | 0 | 111000000 |
| 177 | 192 | 1 | 111000001 |
| 178 | 192 | 2 | 111000010 |
| 179 | 192 | 3 | 111000011 |
| 180 | 192 | 4 | 111000100 |
| 181 | 192 | 5 | 111000101 |
| 182 | 192 | 6 | 111000110 |
| 183 | 192 | 7 | 111000111 |
| 184 | 192 | 8 | 111001000 |
| 185 | 192 | 9 | 111001001 |
| 186 | 192 | 10 | 111001010 |
| 187 | 192 | 11 | 111001011 |
| 188 | 192 | 12 | 111001100 |
| 189 | 192 | 13 | 111001101 |
| 190 | 192 | 14 | 111001110 |
| 191 | 192 | 15 | 111001111 |
| 192 | 192 | 16 | 111010000 |
| 193 | 192 | 17 | 111010001 |
| 194 | 192 | 18 | 111010010 |
| 195 | 192 | 19 | 111010011 |
| 196 | 192 | 20 | 111000100 |
| 197 | 192 | 21 | 111010101 |
| 198 | 192 | 22 | 111010110 |
| 199 | 192 | 23 | 111010111 |
| 200 | 192 | 24 | 111011000 |
| 201 | 192 | 25 | 111011001 |
| 202 | 192 | 26 | 111011010 |
| 203 | 192 | 27 | 111011011 |

Table 7. Register 0x05 Phase Shift Register Settings, Including the Extension Bits and Sign Bit (Bit 7 in Register 0x00) (continued)

| M _{PH} | N _{COARSE} | N _{PH} | B _{PH} |
|-----------------|---------------------|-----------------|-----------------|
| 204 | 192 | 28 | 111011100 |
| 205 | 192 | 29 | 111011101 |
| 206 | 192 | 30 | 111011110 |
| 207 | 192 | 31 | 111011111 |
| 208 | 224 | 0 | 111100000 |
| 209 | 224 | 1 | 111100001 |
| 210 | 224 | 2 | 111100010 |
| 211 | 224 | 3 | 111100011 |
| 212 | 224 | 4 | 111100100 |
| 213 | 224 | 5 | 111100101 |
| 214 | 224 | 6 | 111100110 |
| 215 | 224 | 7 | 111100111 |
| 216 | 224 | 8 | 111101000 |
| 217 | 224 | 9 | 111101001 |
| 218 | 224 | 10 | 111101010 |
| 219 | 224 | 11 | 111101011 |
| 220 | 224 | 12 | 111101100 |
| 221 | 224 | 13 | 111101101 |
| 222 | 224 | 14 | 111101110 |
| 223 | 224 | 15 | 111101111 |
| 224 | 224 | 16 | 111110000 |
| 225 | 224 | 17 | 111110001 |
| 226 | 224 | 18 | 111110010 |
| 227 | 224 | 19 | 111110011 |
| 228 | 224 | 20 | 111110100 |
| 229 | 224 | 21 | 111110101 |
| 230 | 224 | 22 | 111110110 |
| 231 | 224 | 23 | 111110111 |
| 232 | 224 | 24 | 111111000 |
| 233 | 224 | 25 | 111111001 |
| 234 | 224 | 26 | 111111010 |
| 235 | 224 | 27 | 111111011 |
| 236 | 224 | 28 | 111111100 |
| 237 | 224 | 29 | 111111101 |
| 238 | 224 | 30 | 111111110 |
| 239 | 224 | 31 | 111111111 |

APPENDIX

Table 8. Serial Port Register Contents

| ADDR | MSB | [6] | [5] | [4] | [3] | [2] | [1] | LSB | R/W | DEFAULT |
|------|----------------|----------------|----------------|----------------|----------------|----------------|----------------|----------------|-----|---------|
| 0x00 | IQPHSIGN | FREQ[6] | FREQ[5] | FREQ[4] | FREQ[3] | FREQ[2] | FREQ[1] | FREQ[0] | R/W | 0x3E |
| 0x01 | TEMPUPDT | AGCTRL | QDISABLE | GAIN[4] | GAIN[3] | GAIN[2] | GAIN[1] | GAIN[0] | R/W | 0x84 |
| 0x02 | OFFSETI[7] | OFFSETI[6] | OFFSETI[5] | OFFSETI[4] | OFFSETI[3] | OFFSETI[2] | OFFSETI[1] | OFFSETI[0] | R/W | 0x80 |
| 0x03 | OFFSETQ[7] | OFFSETQ[6] | OFFSETQ[5] | OFFSETQ[4] | OFFSETQ[3] | OFFSETQ[2] | OFFSETQ[1] | OFFSETQ[0] | R/W | 0x80 |
| 0x04 | IQGR[7] | IQGR[6] | IQGR[5] | IQGR[4] | IQGR[3] | IQGR[2] | IQGR[1] | IQGR[0] | R/W | 0x80 |
| 0x05 | IQPHE[2] | IQPHE[1] | IQPHE[0] | IQPHF[4] | IQPHF[3] | IQPHF[2] | IQPHF[1] | IQPHF[0] | R/W | 0x10 |
| 0x06 | * | * | * | CLOEN | CLOO[3] | CLOO[2] | CLOO[1] | CLOO[0] | R/W | 0x50 |
| 0x07 | 0 [†] | 0 [†] | 0 [†] | 0 [†] | GAINF[3] | GAINF[2] | GAINF[1] | GAINF[0] | R/W | 0x06 |
| 0x08 | 0 [†] | 0 [†] | 0 [†] | 0 [†] | SRESET | TEMPCORR | THERMINP | * | R/W | 0x00 |
| 0x09 | 0 [†] | 0 [†] | 0 [†] | 0 [†] | 0 [†] | 0 [†] | 0 [†] | 0 [†] | R | 0x00 |
| 0x0A | * [†] | * [†] | * [†] | * [†] | * [†] | * [†] | * [†] | * [†] | R | |
| 0x0B | 0 [†] | 0 [†] | 0 [†] | 0 [†] | FUSE[3] | FUSE[2] | FUSE[1] | FUSE[0] | R | 0x0X |
| 0x0C | 0 [†] | 0 [†] | CPPP0[5] | CPPP0[4] | CPPP0[3] | CPPP0[2] | CPPP0[1] | CPPP0[0] | R | 0xXX |
| 0x0D | 0 [†] | CPPP1[6] | CPPP1[5] | CPPP1[4] | CPPP1[3] | CPPP1[2] | CPPP1[1] | CPPP1[0] | R | 0x0X |
| 0x0E | 0 [†] | 0 [†] | CPPM0[5] | CPPM0[4] | CPPM0[3] | CPPM0[2] | CPPM0[1] | CPPM0[0] | R | 0xXX |
| 0x0F | 0 [†] | CPPM1[6] | CPPM1[5] | CPPM1[4] | CPPM1[3] | CPPM1[2] | CPPM1[1] | CPPM1[0] | R | 0x0X |
| 0x10 | 0 [†] | GPI0[6] | GPI0[5] | GPI0[4] | GPI0[3] | GPI0[2] | GPI0[1] | GPI0[0] | R | 0x08 |
| 0x11 | GPI1[7] | GPI1[6] | GPI1[5] | GPI1[4] | GPI1[3] | GPI1[2] | GPI1[1] | GPI1[0] | R | 0xFF |
| 0x12 | 0 [†] | GPI2[6] | GPI2[5] | GPI2[4] | GPI2[3] | GPI2[2] | GPI2[1] | GPI2[0] | R | 0x01 |
| 0x13 | 0 [†] | GMI0[6] | GMI0[5] | GMI0[4] | GMI0[3] | GMI0[2] | GMI0[1] | GMI0[0] | R | 0x08 |
| 0x14 | GMI1[7] | GMI1[6] | GMI1[5] | GMI1[4] | GMI1[3] | GMI1[2] | GMI1[1] | GMI1[0] | R | 0xFF |
| 0x15 | 0 [†] | GMI2[6] | GMI2[5] | GMI2[4] | GMI2[3] | GMI2[2] | GMI2[1] | GMI2[0] | R | 0x01 |
| 0x16 | 0 [†] | GPQ0[6] | GPQ0[5] | GPQ0[4] | GPQ0[3] | GPQ0[2] | GPQ0[1] | GPQ0[0] | R | 0x08 |
| 0x17 | GPQ1[7] | GPQ1[6] | GPQ1[5] | GPQ1[4] | GPQ1[3] | GPQ1[2] | GPQ1[1] | GPQ1[0] | R | 0xFF |
| 0x18 | 0 [†] | GPQ2[6] | GPQ2[5] | GPQ2[4] | GPQ2[3] | GPQ2[2] | GPQ2[1] | GPQ2[0] | R | 0x01 |
| 0x19 | 0 [†] | GMQ0[6] | GMQ0[5] | GMQ0[4] | GMQ0[3] | GMQ0[2] | GMQ0[1] | GMQ0[0] | R | 0x08 |
| 0x1A | GMQ1[7] | GMQ1[6] | GMQ1[5] | GMQ1[4] | GMQ1[3] | GMQ1[2] | GMQ1[1] | GMQ1[0] | R | 0xFF |
| 0x1B | 0 [†] | GMQ2[6] | GMQ2[5] | GMQ2[4] | GMQ2[3] | GMQ2[2] | GMQ2[1] | GMQ2[0] | R | 0x01 |
| 0x1C | 0 [†] | 0 [†] | 0 [†] | 0 [†] | 0 [†] | 0 [†] | 0 [†] | 0 [†] | R | 0x00 |
| 0x1D | 0 [†] | 0 [†] | 0 [†] | 0 [†] | CLO[3] | CLO[2] | CLO[1] | CLO[0] | R | 0x00 |
| 0x1E | 0 [†] | 0 [†] | 0 [†] | GOR | IDT[3] | IDT[2] | IDT[1] | IDT[0] | R | 0x04 |
| 0x1F | 0 [†] | 0 [†] | 0 [†] | 0 [†] | TEMP[3] | TEMP[2] | TEMP[1] | TEMP[0] | R | 0x0Y |

*unused [†]read-only; values written are disregarded, X = production dependent, Y = resets to 7 after EN from Low to High with TEMPUPDT = 1, for EN = Low all read-only (R) registers default to 0x00.

APPENDIX

Table 9. Serial Port Register Bit Field Summary

| BITS | FUNCTION | DESCRIPTION | VALID VALUES | DEFAULT |
|--------------|--------------------------------|--|--------------|---------|
| AGCTRL | Analog Gain Control Enable | Enables analog control through V_{CTRL} (Pin 1) when AGCTRL = 1. | 0, 1 | 0 |
| CLO[3:0] | LO Port Match Cap Array | LO port match, automatically adjusted through programming FREQ[6:0] | 0x00 to 0x0F | 0x00 |
| CLOO[3:0] | LO Port Cap Array Override | Programs LO port match capacitor array when CLOEN = 0 | 0x00 to 0x0F | 0x00 |
| CLOEN | Automatic LO Match Enable | Automatic LO port impedance matching enabled when CLOEN = 1. Override bits CLOO[3:0] control LO port match when CLOEN = 0. | 0, 1 | 1 |
| CPPM0[5:0] | C_{ppQ} Fine Control | $C_{ppQ} = CPPM0[5:0] + \text{number of 1's in } CPPM1[6:0] \times 64$ | 0x00 to 0x5F | 0xXX |
| CPPM1[6:0] | C_{ppQ} Coarse Control | | 0x00 to 0x7F | 0x0X |
| CPPP0[5:0] | C_{ppi} Fine Control | $C_{ppi} = CPPP0[5:0] + \text{number of 1's in } CPPP1[6:0] \times 64$ | 0x00 to 0x5F | 0xXX |
| CPPP1[6:0] | C_{ppi} Coarse Control | | 0x00 to 0x7F | 0x0X |
| FREQ[6:0] | PolyPhase Filter Frequency | Programs the center frequency of the PolyPhase filter, according to Table 6. | 0x00 to 0x79 | 0x3E |
| FUSE[3:0] | Fuse Read Out | | 0x00 to 0x0F | 0x0X |
| GAIN[4:0] | Coarse Digital Gain Control | Programs the conversion gain in 1dB steps, according to Table 4. | 0x00 to 0x13 | 0x04 |
| GAINF[3:0] | Fine Digital Gain Control | Conversion gain control in approximately 0.1dB steps, when TEMPCORR = 1. | 0x00 to 0x0F | 0x06 |
| GMIO[6:0] | Fine GMI DAC Read-Out | BBMI input stage gain Gml. | 0x00 to 0x7F | 0x08 |
| GMI1[7:0] | Coarse GMI DAC Read-Out1 | $Gml = GMIO[6:0] + (\text{number of 1's in } GMI1[7:0] \text{ and } GMI2[6:0]) \times 128$ | 0x00 to 0x07 | 0xFF |
| GMI2[6:0] | Coarse GMI DAC Read-Out2 | | 0x00 to 0x07 | 0x01 |
| GMQ0[6:0] | Fine GMQ DAC Read-Out | BBMQ input stage gain GmQ. | 0x00 to 0x7F | 0x08 |
| GMQ1[7:0] | Coarse GMQ DAC Read-Out1 | $GmQ = GMQ0[6:0] + (\text{number of 1's in } GMQ1[7:0] \text{ and } GMQ2[6:0]) \times 128$ | 0x00 to 0x07 | 0xFF |
| GMQ2[6:0] | Coarse GMQ DAC Read-Out2 | | 0x00 to 0x07 | 0x01 |
| GOR | Gain Out of Range | For DG < -19 GOR = 1; Else GOR = 0 | 0, 1 | 0 |
| GPI0[6:0] | Fine GPI DAC Read-Out | BBPI input stage gain Gpl. | 0x00 to 0x7F | 0x08 |
| GPI1[7:0] | Coarse GPI DAC Read-Out1 | $Gpl = GPI0[6:0] + (\text{number of 1's in } GPI1[7:0] \text{ and } GPI2[6:0]) \times 128$ | 0x00 to 0x07 | 0xFF |
| GPI2[6:0] | Coarse GPI DAC Read-Out2 | | 0x00 to 0x07 | 0x01 |
| GPQ0[6:0] | Fine GPQ DAC Read-Out | BBPQ input stage gain GpQ. | 0x00 to 0x7F | 0x08 |
| GPQ1[7:0] | Coarse GPQ DAC Read-Out1 | $GpQ = GPQ0[6:0] + (\text{number of 1's in } GPQ1[7:0] \text{ and } GPQ2[6:0]) \times 128$ | 0x00 to 0x07 | 0xFF |
| GPQ2[6:0] | Coarse GPQ DAC Read-Out2 | | 0x00 to 0x07 | 0x01 |
| IDT[3:0] | RF Buffer Bias | | 0x00 to 0x0D | 0x04 |
| IQGR[7:0] | I/Q Gain Ratio Control | Adjust the gain difference in approximate constant steps in dB. See Table 5. | 0x00 to 0xFF | 0x80 |
| IQPHE[2:0] | I/Q Phase Extension Bits | Extend the IQ phase adjustment range. See Table 7. | 0x00 to 0x07 | 0x00 |
| IQPHF[4:0] | Fine I/Q Phase Balance Control | Fine adjustment of IQ LO phase difference. See Table 7. Zero phase shift for 0x10. | 0x00 to 0x1F | 0x10 |
| IQPHSIGN | Sign IQ Phase Extension Bits | Encodes the sign of the IQ phase extension bits IQPHE[2:0]. Positive for IQPHSIGN = 1. | 0, 1 | 0 |
| OFFSETI[7:0] | I-Channel Offset Control | Adjusts DC offset in the I-channel. Zero offset for 0x80. | 0x01 to 0xFF | 0x80 |
| OFFSETQ[7:0] | Q-Channel Offset Control | Adjusts DC offset in the Q-channel. Zero offset for 0x80. | 0x01 to 0xFF | 0x80 |
| QDISABLE | Disable Q-Channel | QDISABLE = 1 shuts down the Q-channel, turning the LTC5589 into an upconversion mixer. | 0, 1 | 0 |
| SRESET | Soft Reset | Writing 1 to this bit resets all registers to their default values. | 0, 1 | 0 |
| TEMP[3:0] | Thermometer Output | Digital representation of die temperature. Step size about 10°C. | 0x00 to 0x07 | 0x07 |
| TEMPCORR | Temperature Correction Disable | TEMPCORR = 1 disables temperature correction of the gain, and enables manual fine-adjustment using bits GAINF[3:0]. | 0, 1 | 0 |
| TEMPUPDT | Temperature Correction Update | TEMPUPDT = 1 synchronizes temperature correction of the gain to a LOW - HIGH transition on the TTCK pin. Asynchronous correction for TEMPUPDT = 0. | 0, 1 | 1 |
| THERMINP | Thermometer Input Select | For test purposes only. Should be set to 0. | 0 | 0 |

