

# Micropower Precision, Dual/Quad CMOS Rail-to-Rail Input/Output Amplifiers

## FEATURES

- **Maximum Offset Voltage of 25 $\mu$ V (25 $^{\circ}$ C)**
- **Maximum Offset Drift of 0.7 $\mu$ V/ $^{\circ}$ C**
- **Maximum Input Bias:**
  - 1 $\mu$ A (25 $^{\circ}$ C)**
  - 50 $\mu$ A ( $\leq$ 85 $^{\circ}$ C)**
- Micropower: 54 $\mu$ A per Amp
- 95dB CMRR (Min)
- 100dB PSRR (Min)
- Input Noise Voltage Density: 16nV/ $\sqrt{\text{Hz}}$
- Rail-to-Rail Inputs and Outputs
- 2.7V to 5.5V Operation Voltage
- LTC6078 Available in 8-Lead MSOP and 10-Lead DFN Packages; LTC6079 Available in 16-Lead SSOP and DFN Packages

## APPLICATIONS

- Photodiode Amplifier
- High Impedance Sensor Amplifier
- Microvolt Accuracy Threshold Detection
- Instrumentation Amplifiers
- Battery Powered Applications

## DESCRIPTION

The LTC<sup>®</sup>6078/LTC6079 are dual/quad, low offset, low noise operational amplifiers with low power consumption and rail-to-rail input/output swing.

Input offset voltage is trimmed to less than 25 $\mu$ V and the CMOS inputs draw less than 50pA of bias current. The low offset drift, excellent CMRR, and high voltage gain make it a good choice for precision signal conditioning.

Each amplifier draws only 54 $\mu$ A current on a 3V supply. The micropower, rail-to-rail operation of the LTC6078/LTC6079 is well suited for portable instruments and single supply applications.

The LTC6078/LTC6079 are specified on power supply voltages of 3V and 5V from  $-40$  to 125 $^{\circ}$ C. The dual amplifier LTC6078 is available in 8-lead MSOP and 10-lead DFN packages. The quad amplifier LTC6079 is available in 16-lead SSOP and DFN packages.

LT, LT, LTC and LTM are registered trademarks of Linear Technology Corporation. All other trademarks are the property of their respective owners. Patent Pending.

## TYPICAL APPLICATION



AMPLIFIER PROTECTED TO  $\pm$ 190V, ACCIDENTAL CONTACT

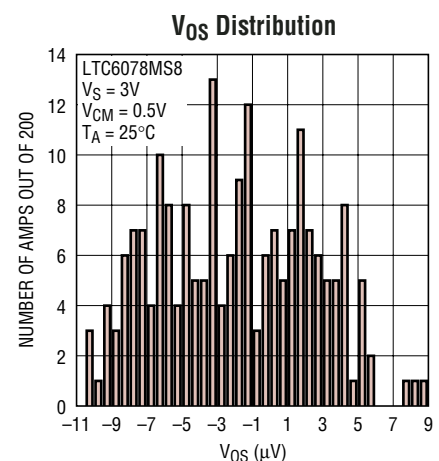

# LTC6078/LTC6079

## ABSOLUTE MAXIMUM RATINGS

(Note 1)

Total Supply Voltage ( $V^+$ to $V^-$ ) .....	6V
Input Voltage.....	$V^-$ to $V^+$
Output Short Circuit Duration (Note 2) .....	Indefinite
Operating Temperature Range (Note 3)	
LTC6078C, LTC6079C .....	-40°C to 85°C
LTC6078I, LTC6079I .....	-40°C to 85°C
LTC6078H, LTC6079H.....	-40°C to 125°C
(Not Available in DFN Package)	

Specified Temperature Range (Note 4)	
LTC6078C, LTC6079C .....	0°C to 70°C
LTC6078I, LTC6079I .....	-40°C to 85°C
LTC6078H, LTC6079H.....	-40°C to 125°C
Junction Temperature	
DFN Packages.....	125°C
All Other Packages.....	150°C
Storage Temperature Range	
DFN Packages.....	-65°C to 125°C
All Other Packages.....	-65°C to 150°C
Lead Temperature (Soldering, 10 Sec).....	300°C

## PACKAGE/ORDER INFORMATION

 <p>DD PACKAGE 10-LEAD (3mm × 3mm) PLASTIC DFN <math>T_{JMAX} = 125^{\circ}\text{C}</math>, <math>\theta_{JA} = 43^{\circ}\text{C/W}</math> UNDERSIDE METAL CONNECTED TO <math>V^-</math></p>	 <p>MS8 PACKAGE 8-LEAD PLASTIC MSOP <math>T_{JMAX} = 150^{\circ}\text{C}</math>, <math>\theta_{JA} = 200^{\circ}\text{C/W}</math></p>	ORDER PART NUMBER	DD PART MARKING*		
		LTC6078CDD LTC6078IDD	LBBB LBBB	ORDER PART NUMBER	MS8 PART MARKING*
 <p>DHC PACKAGE 16-LEAD (5mm × 3mm) PLASTIC DFN <math>T_{JMAX} = 125^{\circ}\text{C}</math>, <math>\theta_{JA} = 43^{\circ}\text{C/W}</math> UNDERSIDE METAL CONNECTED TO <math>V^-</math></p>	 <p>GN PACKAGE 16-LEAD PLASTIC SSOP <math>T_{JMAX} = 150^{\circ}\text{C}</math>, <math>\theta_{JA} = 110^{\circ}\text{C/W}</math></p>	ORDER PART NUMBER	DHC PART MARKING*		
		LTC6078ACMS8 LTC6078CMS8 LTC6078AIMS8 LTC6078IMS8 LTC6078AHMS8 LTC6078HMS8	LTAJZ LTAJZ LTAJZ LTAJZ LTAJZ LTAJZ	ORDER PART NUMBER	GN PART MARKING
		LTC6079CDHC LTC6079IDHC	6079 6079	LTC6079CGN LTC6079IGN LTC6079HGN	6079 6079I 6079H

**Order Options** Tape and Reel: Add #TR  
Lead Free: Add #PBF Lead Free Tape and Reel: Add #TRPBF  
Lead Free Part Marking: <http://www.linear.com/leadfree/>

Consult LTC Marketing for parts specified with wider operating temperature ranges.  
\*The temperature grades and parametric grades are identified by a label on the shipping container.

60789fa

**ELECTRICAL CHARACTERISTICS** The ● denotes the specifications which apply over the full operating temperature range, otherwise specifications are at  $T_A = 25^\circ\text{C}$ . Test conditions are  $V^+ = 3\text{V}$ ,  $V^- = 0\text{V}$ ,  $V_{\text{CM}} = 0.5\text{V}$  unless otherwise noted.

SYMBOL	PARAMETER	CONDITIONS	C, I SUFFIXES			H SUFFIX			UNITS
			MIN	TYP	MAX	MIN	TYP	MAX	
$V_{\text{OS}}$	Offset Voltage (Note 5)	LTC6078MS8, LTC6078AMS8, LTC6079GN							
		$V_{\text{CM}} = 0.5\text{V}, 2.5\text{V}$		±7	±25	±7	±25	μV	
		LTC6078DD, LTC6079DHC		±7	±30			μV	
		LTC6078AMS8	●	±20	±70	±25	±95	μV	
		LTC6078MS8	●	±25	±97	±30	±135	μV	
		LTC6079GN	●	±30	±115	±35	±165	μV	
		LTC6078DD, LTC6079DHC	●	±30	±120			μV	
$\Delta V_{\text{OS}}/\Delta T$	Input Offset Voltage Drift (Note 5)	LTC6078AMS8	●	±0.2	±0.7	±0.2	±0.7	μV/°C	
		LTC6078MS8	●		±1.1		±1.1	μV/°C	
		LTC6078DD, LTC6079GN	●	±0.3	±1.4	±0.3	±1.4	μV/°C	
		LTC6079DHC	●	±0.3	±1.8			μV/°C	
$I_{\text{B}}$	Input Bias Current (Note 6)	$V_{\text{CM}} = V^+/2$		0.2	1	0.2	1	pA	
		$V_{\text{CM}} = V^+/2$	●	10	50	150	350	pA	
$I_{\text{OS}}$	Input Offset Current (Note 6)	$V_{\text{CM}} = V^+/2$		0.1		0.1		pA	
		$V_{\text{CM}} = V^+/2$	●	0.5	25	10	100	pA	
$e_{\text{n}}$	Input Noise Voltage	0.1Hz to 10Hz		1		1		μV <sub>P-P</sub>	
		Input Noise Voltage Density	f = 1kHz	18		18		nV/√Hz	
		f = 10kHz		16		16		nV/√Hz	
$i_{\text{n}}$	Input Noise Current Density (Note 8)			0.56		0.56		fA/√Hz	
		Input Common Mode Range	●	V <sup>-</sup>	V <sup>+</sup>	V <sup>-</sup>	V <sup>+</sup>	V	
$C_{\text{DIFF}}$	Differential Input Capacitance			10		10		pF	
$C_{\text{CM}}$	Common Mode Input Capacitance			18		18		pF	
CMRR	Common Mode Rejection Ratio	All Packages		95	110	95	110	dB	
		LTC6078AMS8	●	87	105	87	103	dB	
		LTC6078AMS8	●	91	103	91	103	dB	
		LTC6078MS8	●	85	102	85	100	dB	
		LTC6078MS8	●	89	102	89	102	dB	
		LTC6079GN	●	84	102	84	100	dB	
		LTC6079GN	●	88	102	88	102	dB	
		LTC6078DD, LTC6079DHC	●	83	100			dB	
		LTC6078DD, LTC6079DHC	●	87	102			dB	
PSRR	Power Supply Rejection Ratio	$V_{\text{S}} = 2.7\text{V to } 5.5\text{V}$		100	120	100	120	dB	
			●	97		97		dB	
$V_{\text{OUT}}$	Output Voltage, High (Referred to V <sup>+</sup> )	No Load			1		1	mV	
		$I_{\text{SOURCE}} = 0.2\text{mA}$	●	35	15	40	15	mV	
		$I_{\text{SOURCE}} = 2\text{mA}$	●	350	150	400	150	mV	
$V_{\text{OUT}}$	Output Voltage, Low (Referred to V <sup>-</sup> )	No Load			1		1	mV	
		$I_{\text{SINK}} = 0.2\text{mA}$	●		10	30	10	35	mV
		$I_{\text{SINK}} = 2\text{mA}$	●		100	300	100	350	mV
$A_{\text{VOL}}$	Large-Signal Voltage Gain	$R_{\text{LOAD}} = 10\text{k}, 0.5\text{V} \leq V_{\text{OUT}} \leq 2.5\text{V}$	●	115	130	110	125	dB	
$I_{\text{SC}}$	Output Short-Circuit Current	Source	●	5	10	4	10	mA	
		Sink	●	7	14	6	14	mA	
SR	Slew Rate	$A_{\text{V}} = 1$		0.05		0.05		V/μs	
GBW	Gain-Bandwidth Product ( $f_{\text{TEST}} = 10\text{kHz}$ )			420	750	420	750	kHz	
		●		360		320		kHz	
$\Phi_0$	Phase Margin	$R_{\text{L}} = 10\text{k}, C_{\text{L}} = 200\text{pF}$		66		66		Deg	
$t_{\text{S}}$	Settling Time 0.1%	$A_{\text{V}} = 1, 1\text{V Step}$		24		24		μs	

# LTC6078/LTC6079

**ELECTRICAL CHARACTERISTICS** The ● denotes the specifications which apply over the full operating temperature range, otherwise specifications are at  $T_A = 25^\circ\text{C}$ . Test conditions are  $V^+ = 3\text{V}$ ,  $V^- = 0\text{V}$ ,  $V_{\text{CM}} = 0.5\text{V}$  unless otherwise noted.

SYMBOL	PARAMETER	CONDITIONS	C, I SUFFIXES			H SUFFIX			UNITS
			MIN	TYP	MAX	MIN	TYP	MAX	
$I_S$	Supply Current (per Amplifier)	No Load	●	54	72 78		54	72 80	$\mu\text{A}$ $\mu\text{A}$
	Shutdown Current (per Amplifier)	Shutdown, $V_{\text{SHDN}} \leq 0.8\text{V}$ , LTC6078DD	●	0.3	1				$\mu\text{A}$
$V_S$	Supply Voltage Range	Guaranteed by the PSRR Test	●	2.7	5.5		2.7	5.5	V
	Channel Separation	$f_s = 10\text{kHz}$ , $R_L = 10\text{k}$		-110			-110		dB
	Shutdown Logic	$\overline{\text{SHDN}}$ High, LTC6078DD $\overline{\text{SHDN}}$ Low, LTC6078DD	● ●	2	0.8		2	0.8	V V
$t_{\text{ON}}$	Turn on Time	$V_{\text{SHDN}} = 0.8\text{V}$ to $2\text{V}$ , LTC6078DD		50			50		$\mu\text{s}$
$t_{\text{OFF}}$	Turn off Time	$V_{\text{SHDN}} = 2\text{V}$ to $0.8\text{V}$ , LTC6078DD		2			2		$\mu\text{s}$
	Leakage of $\overline{\text{SHDN}}$ Pin	$V_{\text{SHDN}} = 0\text{V}$ , LTC6078DD		0.6					$\mu\text{A}$

The ● denotes the specifications which apply over the full operating temperature range, otherwise specifications are at  $T_A = 25^\circ\text{C}$ . Test conditions are  $V^+ = 5\text{V}$ ,  $V^- = 0\text{V}$ ,  $V_{\text{CM}} = 0.5\text{V}$  unless otherwise noted.

SYMBOL	PARAMETER	CONDITIONS	C, I SUFFIXES			H SUFFIX			UNITS
			MIN	TYP	MAX	MIN	TYP	MAX	
$V_{\text{OS}}$	Offset Voltage	LTC6078MS8, LTC6078AMS8, LTC6079GN $V_{\text{CM}} = 0.5\text{V}$	●	$\pm 10$	$\pm 30$		$\pm 10$	$\pm 30$	$\mu\text{V}$
		LTC6078DD, LTC6079DHC $V_{\text{CM}} = 0.5\text{V}$		$\pm 10$	$\pm 35$				$\mu\text{V}$
		LTC6078AMS8 $V_{\text{CM}} = 0.5\text{V}$	●	$\pm 20$	$\pm 75$		$\pm 25$	$\pm 100$	$\mu\text{V}$
		LTC6078MS8 $V_{\text{CM}} = 0.5\text{V}$	●	$\pm 25$	$\pm 102$		$\pm 30$	$\pm 140$	$\mu\text{V}$
		LTC6079GN $V_{\text{CM}} = 0.5\text{V}$	●	$\pm 30$	$\pm 120$		$\pm 35$	$\pm 170$	$\mu\text{V}$
		LTC6078DD $V_{\text{CM}} = 0.5\text{V}$	●	$\pm 30$	$\pm 125$				$\mu\text{V}$
		LTC6079DHC $V_{\text{CM}} = 0.5\text{V}$	●	$\pm 35$	$\pm 155$				$\mu\text{V}$
$\Delta V_{\text{OS}}/\Delta T$	Input Offset Voltage Drift (Note 7)	LTC6078AMS8	●	$\pm 0.2$	$\pm 0.7$		$\pm 0.2$	$\pm 0.7$	$\mu\text{V}/^\circ\text{C}$
		LTC6078MS8	●		$\pm 1.1$			$\pm 1.1$	$\mu\text{V}/^\circ\text{C}$
		LTC6078DD, LTC6079GN	●	$\pm 0.3$	$\pm 1.4$		$\pm 0.3$	$\pm 1.4$	$\mu\text{V}/^\circ\text{C}$
		LTC6079DHC	●	$\pm 0.3$	$\pm 1.8$				$\mu\text{V}/^\circ\text{C}$
$I_B$	Input Bias Current	$V_{\text{CM}} = V^+/2$	●	0.2	1		0.2	1	pA
		$V_{\text{CM}} = V^+/2$		10	50		150	350	pA
$I_{\text{OS}}$	Input Offset Current	$V_{\text{CM}} = V^+/2$	●	0.1			0.1		pA
		$V_{\text{CM}} = V^+/2$		0.5	25		10	100	pA
$e_n$	Input Noise Voltage	0.1Hz to 10Hz		1			1		$\mu\text{V}_{\text{P-P}}$
		Input Noise Voltage Density		18			18		$\text{nV}/\sqrt{\text{Hz}}$
$i_n$	Input Noise Current Density (Note 8)	$f = 1\text{kHz}$		16			16		$\text{nV}/\sqrt{\text{Hz}}$
		$f = 10\text{kHz}$		0.56			0.56		$\text{fA}/\sqrt{\text{Hz}}$
	Input Common Mode Range		●	$V^-$	$V^+$		$V^-$	$V^+$	V
$C_{\text{DIFF}}$	Differential Input Capacitance			10			10		pF
$C_{\text{CM}}$	Common Mode Input Capacitance			18			18		pF

## ELECTRICAL CHARACTERISTICS

The ● denotes the specifications which apply over the full operating temperature range, otherwise specifications are at  $T_A = 25^\circ\text{C}$ . Test conditions are  $V^+ = 5\text{V}$ ,  $V^- = 0\text{V}$ ,  $V_{\text{CM}} = 0.5\text{V}$  unless otherwise noted.

SYMBOL	PARAMETER	CONDITIONS	C, I SUFFIXES			H SUFFIX			UNITS
			MIN	TYP	MAX	MIN	TYP	MAX	
CMRR	Common Mode Rejection Ratio	All Packages	$V_{\text{CM}} = 0\text{V to } 5\text{V}$	●	91	105	91	105	dB
		LTC6078AMS8	$V_{\text{CM}} = 0\text{V to } 5\text{V}$	●	90	105	90	105	dB
		LTC6078AMS8	$V_{\text{CM}} = 0\text{V to } 3.7\text{V}$	●	94	105	94	105	dB
		LTC6078MS8	$V_{\text{CM}} = 0\text{V to } 5\text{V}$	●	88	100	88	100	dB
		LTC6078MS8	$V_{\text{CM}} = 0\text{V to } 3.7\text{V}$	●	90	105	90	105	dB
		LTC6079GN	$V_{\text{CM}} = 0\text{V to } 5\text{V}$	●	86	100	86	100	dB
		LTC6079GN	$V_{\text{CM}} = 0\text{V to } 3.7\text{V}$	●	90	105	90	105	dB
		LTC6078DD, LTC6079DHC	$V_{\text{CM}} = 0\text{V to } 5\text{V}$	●	86	100			dB
		LTC6078DD, LTC6079DHC	$V_{\text{CM}} = 0\text{V to } 3.7\text{V}$	●	90	105			dB
PSRR	Power Supply Rejection Ratio	$V_S = 2.7\text{V to } 5.5\text{V}$	●	100	120			dB	
				97		97	120		dB
$V_{\text{OUT}}$	Output Voltage, High (Referred to $V^+$ )	No Load	●		2		2	mV	
		$I_{\text{SOURCE}} = 0.5\text{mA}$	●	50	20	55	20	mV	
		$I_{\text{SOURCE}} = 5\text{mA}$	●	500	200	550	200	mV	
	Output Voltage, Low (Referred to $V^-$ )	No Load	●		1		1	mV	
$I_{\text{SINK}} = 0.5\text{mA}$		●		15	40	15	45	mV	
	$I_{\text{SINK}} = 5\text{mA}$	●		150	400	150	450	mV	
$A_{\text{VOL}}$	Large-Signal Voltage Gain	$R_{\text{LOAD}} = 10\text{k}, 0.5\text{V} \leq V_{\text{OUT}} \leq 4.5\text{V}$	●	115	130	110	125	dB	
$I_{\text{SC}}$	Output Short-Circuit Current	Source	●	14	25	12	25	mA	
		Sink	●	14	25	12	25	mA	
SR	Slew Rate	$A_V = 1$			0.05		0.05	V/ $\mu\text{s}$	
GBW	Gain-Bandwidth Product ( $f_{\text{TEST}} = 10\text{kHz}$ )	$R_L = 100\text{k}$	●	420	750	420	750	kHz	
				360		320		kHz	
$\Phi_0$	Phase Margin	$R_L = 10\text{k}, C_L = 200\text{pF}$			66		66	Deg	
$t_S$	Settling Time 0.1%	$A_V = 1, 1\text{V Step}$			24		24	$\mu\text{s}$	
$I_S$	Supply Current (per Amplifier)	No Load	●		55	74	55	74	$\mu\text{A}$
						82		84	$\mu\text{A}$
	Shutdown Current (per Amplifier)	Shutdown, $V_{\text{SHDN}} \leq 1.2\text{V}$ , LTC6078DD	●		1.5	5	1.5	5	$\mu\text{A}$
$V_S$	Supply Voltage Range	Guaranteed by the PSRR Test	●	2.7	5.5	2.7	5.5	V	
	Channel Separation	$f_S = 10\text{kHz}, R_L = 10\text{k}$			-110		-110	dB	
	Shutdown Logic	$\overline{\text{SHDN}}$ High, LTC6078DD SHDN Low, LTC6078DD	●	3.5		3.5		V	
			●		1.2		1.2	V	
$t_{\text{ON}}$	Turn on Time	$V_{\text{SHDN}} = 1.2\text{V to } 3.5\text{V}$ , LTC6078DD			50		50	$\mu\text{s}$	
$t_{\text{OFF}}$	Turn off Time	$V_{\text{SHDN}} = 1.2\text{V to } 3.5\text{V}$ , LTC6078DD			2		2	$\mu\text{s}$	
	Leakage of SHDN Pin	$V_{\text{SHDN}} = 0\text{V}$ , LTC6078DD			0.6			$\mu\text{A}$	

**Note 1:** Stresses beyond those listed under Absolute Maximum Ratings may cause permanent damage to the device. Exposure to any Absolute Maximum Rating condition for extended periods may affect device reliability and lifetime.

**Note 2:** A heat sink may be required to keep the junction temperature below the absolute maximum. This depends on the power supply voltage and how many amplifiers are shorted.

**Note 3:** The LTC6078C/LTC6079C and LTC6078I/LTC6079I are guaranteed functional over the operating temperature range of  $-40^\circ\text{C}$  to  $85^\circ\text{C}$ . The LTC6078H/LTC6079H are guaranteed functional over the operating temperature range of  $-40^\circ\text{C}$  to  $125^\circ\text{C}$ .

**Note 4:** The LTC6078C/LTC6079C are guaranteed to meet specified

performance from  $0^\circ\text{C}$  to  $70^\circ\text{C}$ . The LTC6078C/LTC6079C are designed, characterized and expected to meet specified performance from  $-40^\circ\text{C}$  to  $85^\circ\text{C}$  but are not tested or QA sampled at these temperatures. The LTC6078I/LTC6079I are guaranteed to meet specified performance from  $-40^\circ\text{C}$  to  $85^\circ\text{C}$ . The LTC6078H/LTC6079H are guaranteed to meet specified performance from  $-40^\circ\text{C}$  to  $125^\circ\text{C}$ .

**Note 5:**  $V_{\text{OS}}$  and  $V_{\text{OS}}$  drift are 100% tested at  $25^\circ\text{C}$  and  $125^\circ\text{C}$ .

**Note 6:**  $I_B$  and  $I_{\text{OS}}$  are guaranteed by the  $V_S = 5\text{V}$  test.

**Note 7:**  $V_{\text{OS}}$  drift is guaranteed by the  $V_S = 3\text{V}$  test.

**Note 8:** Current noise is calculated from  $i_n = \sqrt{2q}I_B$ , where  $q = 1.6 \cdot 10^{-19}$  coulomb.

## TYPICAL PERFORMANCE CHARACTERISTICS

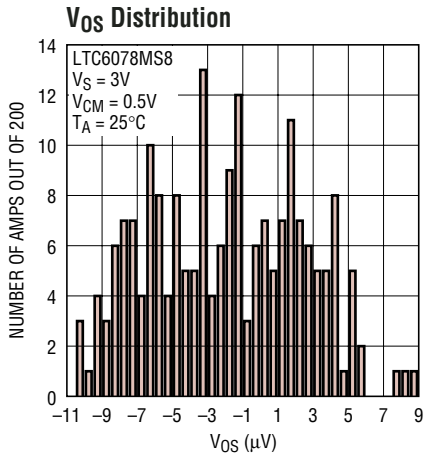

60789 G01



60789 G02



60789 G03



60789 G04



60789 G05

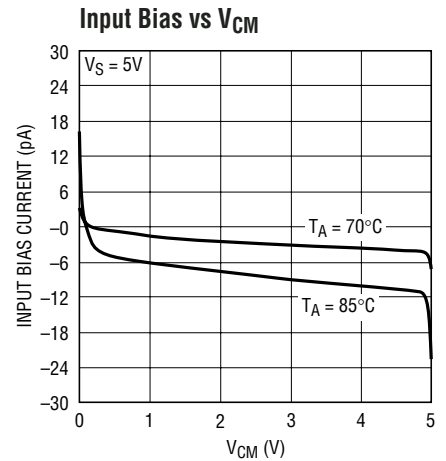

60789 G06



60789 G07



60789 G08

### 0.1Hz to 10Hz Output Voltage Noise

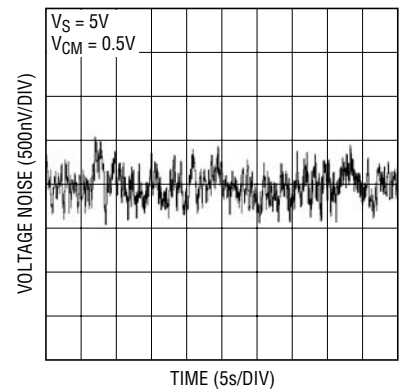

60789 G09

# TYPICAL PERFORMANCE CHARACTERISTICS

**Output Voltage Swing vs Load Current**



60789 G10

**Supply Current vs Supply Voltage**

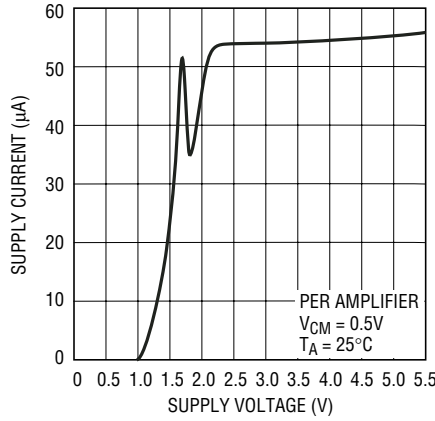

60789 G11

**Supply Current vs Temperature**

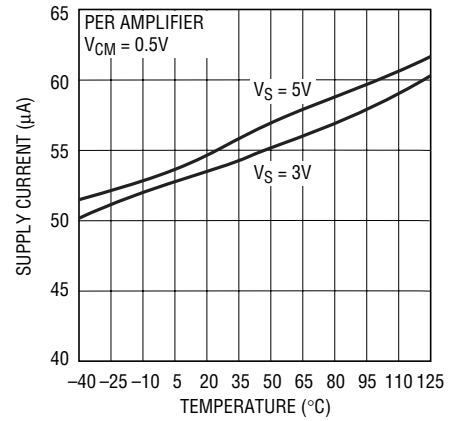

60789 G12

**Open Loop Gain vs Frequency**

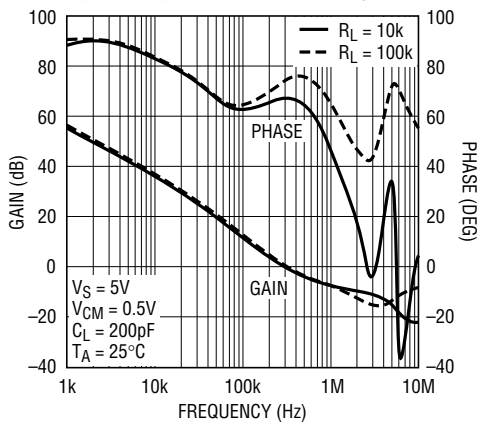

60789 G13

**CMRR vs Frequency**

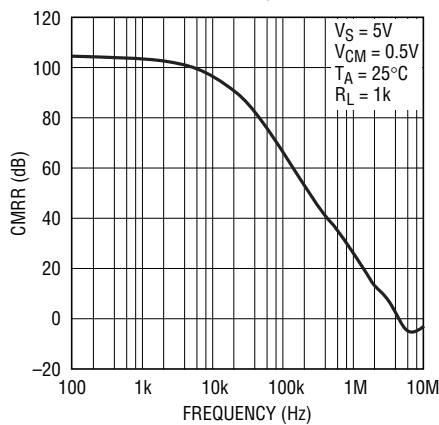

60789 G14

**PSRR vs Frequency**

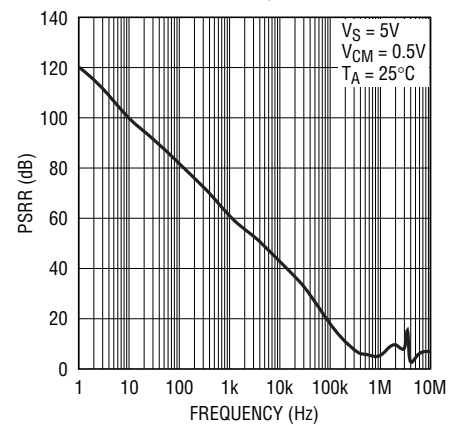

60789 G15

**Output Impedance vs Frequency**

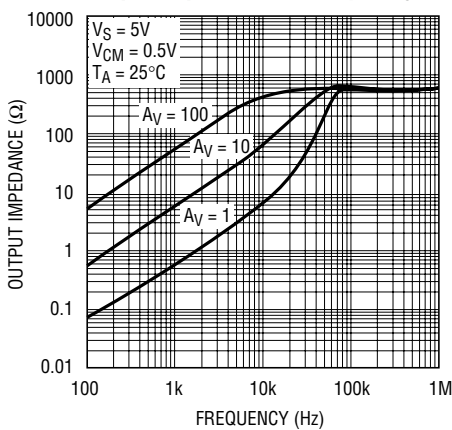

60789 G16

**Small Signal Transient**

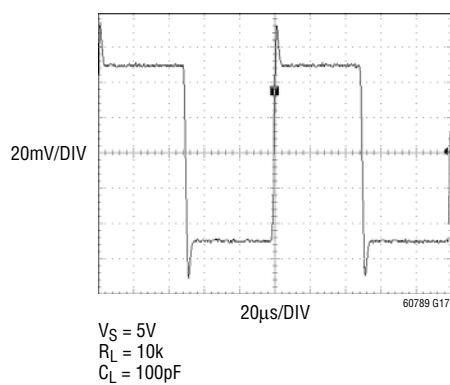

60789 G17

**Large Signal Transient**

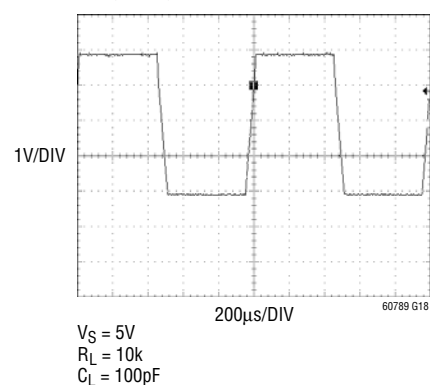

60789 G18

## TYPICAL PERFORMANCE CHARACTERISTICS

Disabled Output Impedance vs Frequency

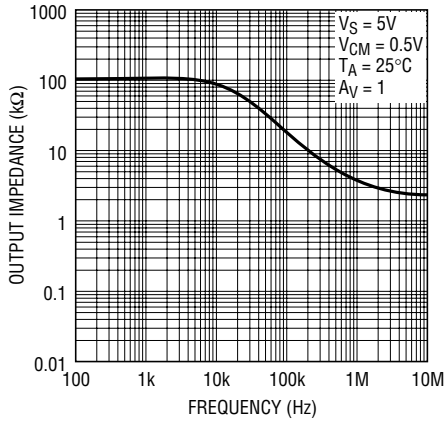

60789 G19

Overshoot vs  $C_L$

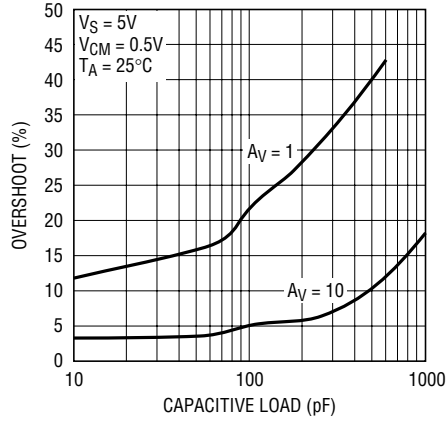

60789 G20

Channel Separation vs Frequency

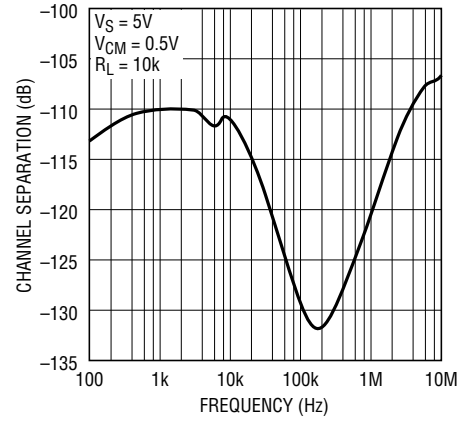

60789 G21

## PIN FUNCTIONS

**OUT:** Amplifier Output

**-IN:** Inverting Input

**+IN:** Noninverting Input

**V+:** Positive Supply

**V-:** Negative Supply

**SHDN\_A:** Shutdown Pin of Amplifier A, active low and only valid for LTC6078DD. An internal current source pulls the pin to  $V^+$  when floating.

**SHDN\_B:** Shutdown Pin of Amplifier B, active low and only valid for LTC6078DD. An internal current source pulls the pin to  $V^+$  when floating.

**NC:** Not internally connected.

**Exposed Pad:** Connected to  $V^-$ .



## APPLICATIONS INFORMATION

### Preserving Input Precision

Preserving input accuracy of the LTC6078/LTC6079 requires that the application circuit and PC board layout do not introduce errors comparable or greater than the  $10\mu\text{V}$  typical offset of the amplifiers. Temperature differentials across the input connections can generate thermocouple voltages of 10's of microvolts so the connections to the input leads should be short, close together and away from heat dissipating components. Air current across the board can also generate temperature differentials.

The extremely low input bias currents ( $0.2\text{pA}$  typical) allow high accuracy to be maintained with high impedance sources and feedback resistors. Leakage currents on the PC board can be higher than the input bias current. For example,  $10\text{G}\Omega$  of leakage between a  $5\text{V}$  supply lead and an input lead will generate  $500\text{pA}$ ! Surround the input leads with a guard ring driven to the same potential as the input common mode to avoid excessive leakage in high impedance applications.

### Input Clamps

Large differential voltages across the inputs over very long time periods can impact the precisely trimmed input offset voltage of the LTC6078/LTC6079. As an example, a  $2\text{V}$  differential voltage between the inputs over a period of 100 hours can shift the input offset voltage by tens of microvolts. If the amplifier is to be subjected to large differential input voltages, adding back-to-back diodes between the two inputs will minimize this shift and retain the DC precision. If necessary, current-limiting series resistors can be added in front of the diodes, as shown in Figure 1. These diodes are not necessary for normal closed loop applications.



Figure 1. Op Amp with Input Voltage Clamp

### Capacitive Load

LTC6078/LTC6079 can drive capacitive load up to  $200\text{pF}$  in unity gain. The capacitive load driving capability increases as the amplifier is used in higher gain configurations. A small series resistance between the output and the load further increases the amount of capacitance the amplifier can drive.

### SHDN Pins

Pins 5 and 6 are used for power shutdown on the LTC6078 in the DD package. If they are floating, internal current sources pull Pins 5 and 6 to  $V+$  and the amplifiers operate normally. In shutdown, the amplifier output is high impedance, and each amplifier draws less than  $2\mu\text{A}$  current.

When the chip is turned on, the supply current per amplifier is about  $35\mu\text{A}$  larger than its normal values for  $50\mu\text{s}$ .

### Rail-to-Rail Input

The input stage of LTC6078/LTC6079 combines both PMOS and NMOS differential pairs, extending its input common mode voltage range to both positive and negative supply voltages. At high input common mode range, the NMOS pair is on. At low common mode range, the PMOS pair is on. The transition happens when the common voltage is between  $1.3\text{V}$  and  $0.9\text{V}$  below the positive supply.

### Thermal Hysteresis

Figure 2 shows the input offset hysteresis of LTC6078MS8 for 3 thermal cycles from  $-45^\circ\text{C}$  to  $90^\circ\text{C}$ . The typical offset shift after the 3 cycles is only  $1\mu\text{V}$ .



Figure 2.  $V_{OS}$  Thermal Hysteresis of LTC6078MS8

## APPLICATIONS INFORMATION

### PC Board Layout

Mechanical stress on a PC board and soldering-induced stress can cause the  $V_{OS}$  and  $V_{OS}$  drift to shift. The DD and DHC packages are more sensitive to stress. A simple way to reduce the stress-related shifts is to mount the IC near the short edge of the PC board, or in a corner. The board edge acts as a stress boundary, or a region where the flexure of the board is minimum. The package should always be mounted so that the leads absorb the stress and not the package. The package is generally aligned with the leads parallel to the long side of the PC board.

The most effective technique to relieve the PC board stress is to cut slots in the board around the op amp. These slots can be cut on three sides of the IC and the leads can exit on

the fourth side. Figure 3 shows the layout of a LTC6078DD with slots at three sides.

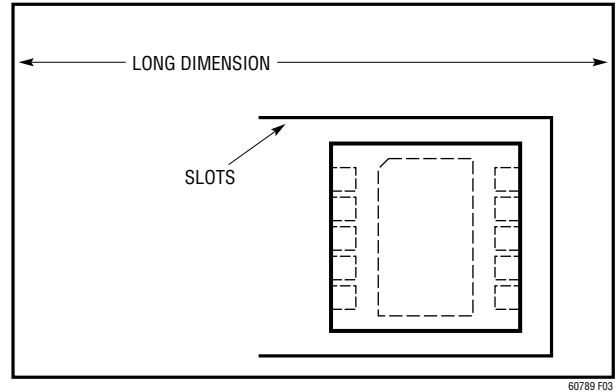

Figure 3. Vertical Orientation of LTC6078DD with Slots

## SIMPLIFIED SCHEMATIC



Simplified Schematic of the Amplifier

# TYPICAL APPLICATIONS

## 2.7V High Side Current Sense



## Low Average Power IR LED Driver

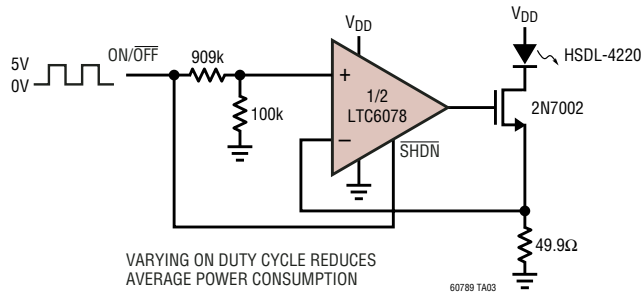

## Accelerometer Signal Conditioner

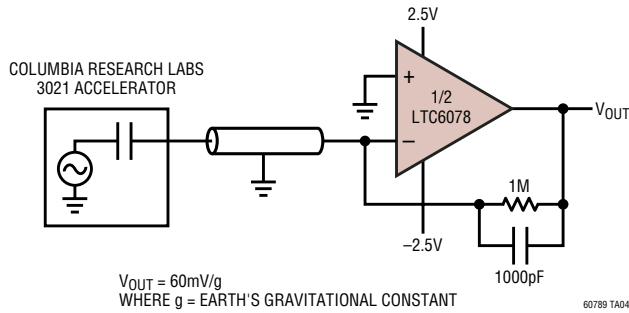

## Photodiode Amplifier

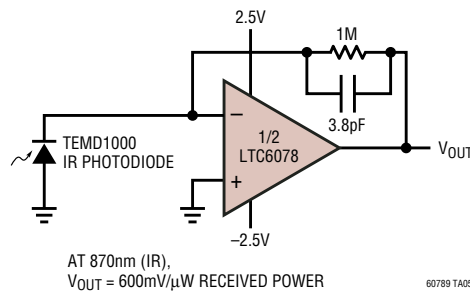

TYPICAL APPLICATIONS

6 Decade Current Log Amplifier



Humidity Sensor Signal Conditioner



60789fa

# TYPICAL APPLICATIONS

## LDO Load Balancing



## pH Probe Amplifier

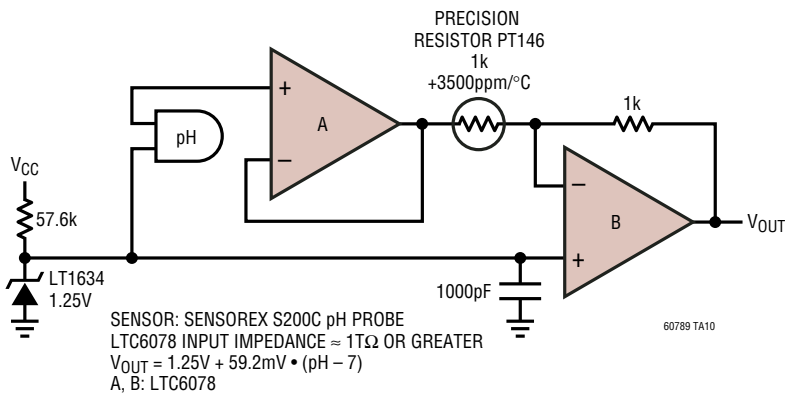

## TYPICAL APPLICATIONS

### Thermistor Amplifier with Overtemperature Alarm



A TO D: LTC6079,  $V_{DD} = 2.7V$  TO  $5.5V$ ,  $V_{SS} = GND$   
 $V_{OUT} = 0 \rightarrow 1V$  FOR  $0^{\circ}C$  TO  $100^{\circ}C$ , LINEAR  
 $T_{OV} \rightarrow$  HIGH WHEN  $T \geq 90^{\circ}C$

### Precision Sample-and-Hold

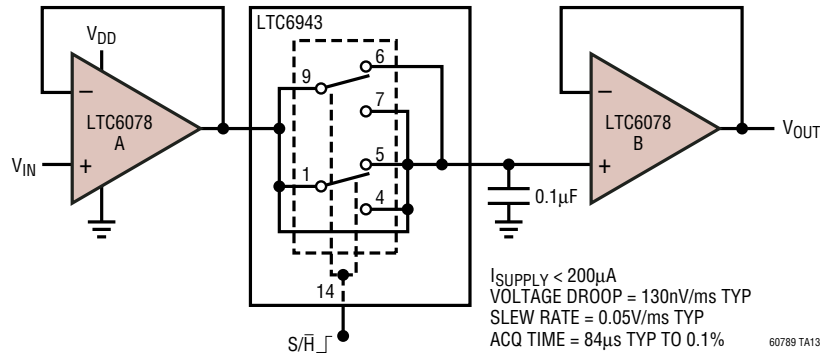

$I_{SUPPLY} < 200\mu A$   
 VOLTAGE DROOP =  $130nV/ms$  TYP  
 SLEW RATE =  $0.05V/ms$  TYP  
 ACQ TIME =  $84\mu s$  TYP TO 0.1%

60789 TA13

## TYPICAL APPLICATIONS

### Precision Voltage-Controlled Current Source



### 60Hz Notch



# PACKAGE DESCRIPTION

**DD Package**  
**10-Lead Plastic DFN (3mm × 3mm)**  
 (Reference LTC DWG # 05-08-1699)



**RECOMMENDED SOLDER PAD PITCH AND DIMENSIONS**



**NOTE:**

1. DRAWING TO BE MADE A JEDEC PACKAGE OUTLINE M0-229 VARIATION OF (WEED-2). CHECK THE LTC WEBSITE DATA SHEET FOR CURRENT STATUS OF VARIATION ASSIGNMENT
2. DRAWING NOT TO SCALE
3. ALL DIMENSIONS ARE IN MILLIMETERS
4. DIMENSIONS OF EXPOSED PAD ON BOTTOM OF PACKAGE DO NOT INCLUDE MOLD FLASH. MOLD FLASH, IF PRESENT, SHALL NOT EXCEED 0.15mm ON ANY SIDE
5. EXPOSED PAD SHALL BE SOLDER PLATED
6. SHADED AREA IS ONLY A REFERENCE FOR PIN 1 LOCATION ON THE TOP AND BOTTOM OF PACKAGE



# PACKAGE DESCRIPTION

## DHC Package 16-Lead Plastic DFN (5mm × 3mm) (Reference LTC DWG # 05-08-1706)

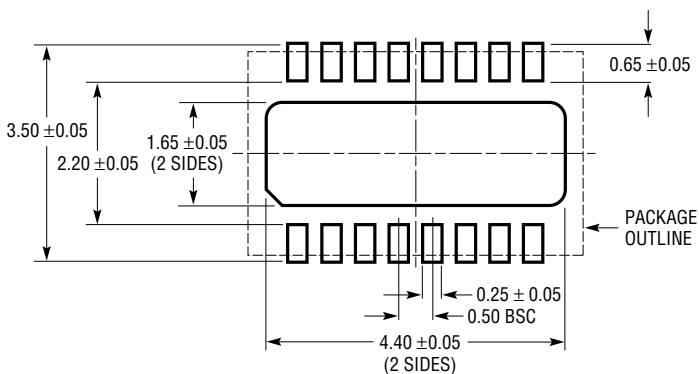

RECOMMENDED SOLDER PAD PITCH AND DIMENSIONS

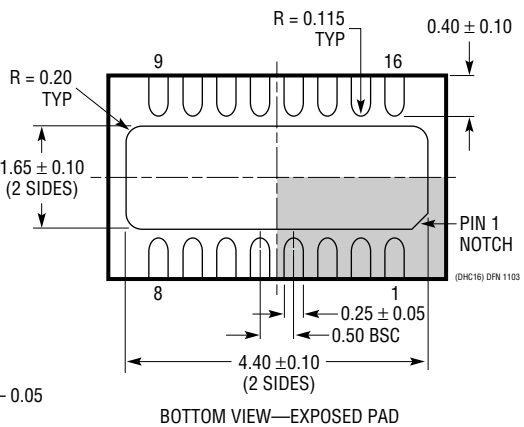
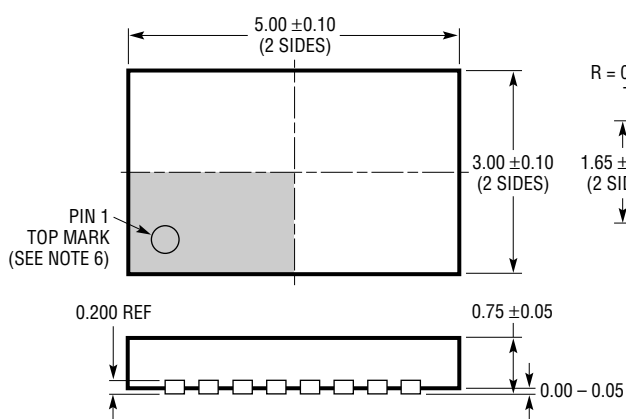

NOTE:

1. DRAWING PROPOSED TO BE MADE VARIATION OF VERSION (WJED-1) IN JEDEC PACKAGE OUTLINE MO-229
2. DRAWING NOT TO SCALE
3. ALL DIMENSIONS ARE IN MILLIMETERS
4. DIMENSIONS OF EXPOSED PAD ON BOTTOM OF PACKAGE DO NOT INCLUDE MOLD FLASH. MOLD FLASH, IF PRESENT, SHALL NOT EXCEED 0.15mm ON ANY SIDE
5. EXPOSED PAD SHALL BE SOLDER PLATED
6. SHADED AREA IS ONLY A REFERENCE FOR PIN 1 LOCATION ON THE TOP AND BOTTOM OF PACKAGE

**PACKAGE DESCRIPTION**

**MS8 Package  
8-Lead Plastic MSOP**

(Reference LTC DWG # 05-08-1660)

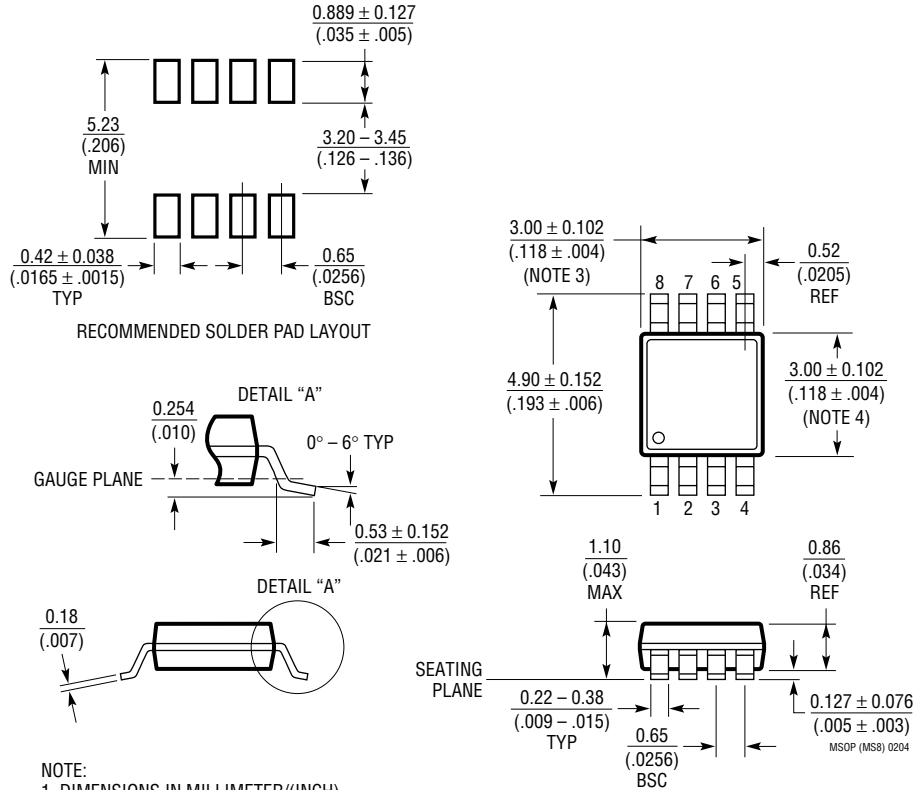

**NOTE:**

1. DIMENSIONS IN MILLIMETER/(INCH)
2. DRAWING NOT TO SCALE
3. DIMENSION DOES NOT INCLUDE MOLD FLASH, PROTRUSIONS OR GATE BURRS.  
MOLD FLASH, PROTRUSIONS OR GATE BURRS SHALL NOT EXCEED 0.152mm (.006") PER SIDE
4. DIMENSION DOES NOT INCLUDE INTERLEAD FLASH OR PROTRUSIONS.  
INTERLEAD FLASH OR PROTRUSIONS SHALL NOT EXCEED 0.152mm (.006") PER SIDE
5. LEAD COPLANARITY (BOTTOM OF LEADS AFTER FORMING) SHALL BE 0.102mm (.004") MAX

# PACKAGE DESCRIPTION

## GN Package 16-Lead Plastic SSOP (Narrow .150 Inch) (Reference LTC DWG # 05-08-1641)

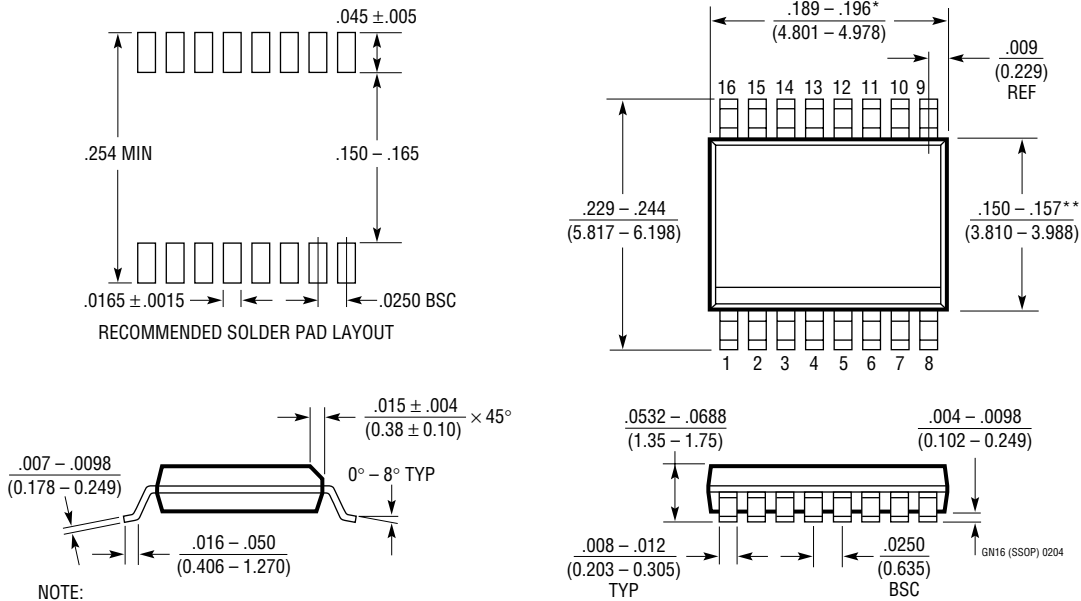

- NOTE:
1. CONTROLLING DIMENSION: INCHES
  2. DIMENSIONS ARE IN  $\frac{\text{INCHES}}{\text{MILLIMETERS}}$
  3. DRAWING NOT TO SCALE
- \*DIMENSION DOES NOT INCLUDE MOLD FLASH. MOLD FLASH SHALL NOT EXCEED  $0.006^*$  ( $0.152\text{mm}$ ) PER SIDE
- \*\*DIMENSION DOES NOT INCLUDE INTERLEAD FLASH. INTERLEAD FLASH SHALL NOT EXCEED  $0.010^*$  ( $0.254\text{mm}$ ) PER SIDE