

Low Distortion, Low Noise Differential IF Amplifier with Configurable Input Impedance

FEATURES

- **1.4GHz –3dB Bandwidth**
- **Fixed Voltage Gain of 6dB (50Ω System)**
- **Configurable Input Impedance Allows:**
 - Simple Interface to Active Mixers
 - Improved Noise Performance
- **Wide 2.8V to 5.25V Supply Range**
- **Low Distortion:**
 - 36dBm OIP3 (70MHz)
 - 33dBm OIP3 (140MHz)
 - 31dBm OIP3 (300MHz)
- **Low Noise:**
 - 11dB NF (50Ω Z_{IN})
 - 8dB NF (200Ω Z_{IN})
- **Differential Inputs and Outputs**
- **Self-Biasing Inputs/Outputs**
- **Shutdown Mode**
- **Minimal Support Circuitry Required**
- **16-Lead 3mm × 3mm × 0.8mm QFN Package**

DESCRIPTION

The LTC®6410-6 is a low distortion, low noise differential IF amplifier with configurable input impedance designed for use in applications from DC to 1.4GHz. The LTC6410-6 has 6dB of voltage gain. The LTC6410-6 is an excellent choice for interfacing active mixers to SAW filters. It features an active input termination that allows a customized input impedance for an optimum interface to differential active mixers. This feature provides additional power gain because of the impedance conversion and improved noise performance when compared to traditional 50Ω interface circuits. The LTC6410-6 drives a differential 50Ω load directly with low distortion, which is suitable for driving SAW filters and other 50Ω signal chain blocks.

The LTC6410-6 operates on 3V or 5V supplies. It comes in a compact 16-lead 3mm × 3mm QFN package and operates over a –40°C to 85°C temperature range.

LT, LT, LTC and LTM are registered trademarks of Linear Technology Corporation. All other trademarks are the property of their respective owners.

APPLICATIONS

- **Post-Mixer Gain Block**
- **SAW Filter Interface/Buffering**
- **Differential IF Signal Chain Gain Block**
- **Differential Line Driver/Receiver**

TYPICAL APPLICATION

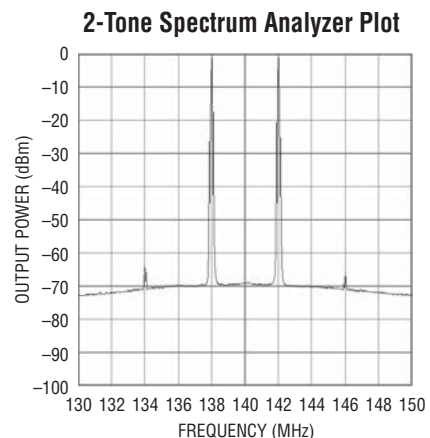
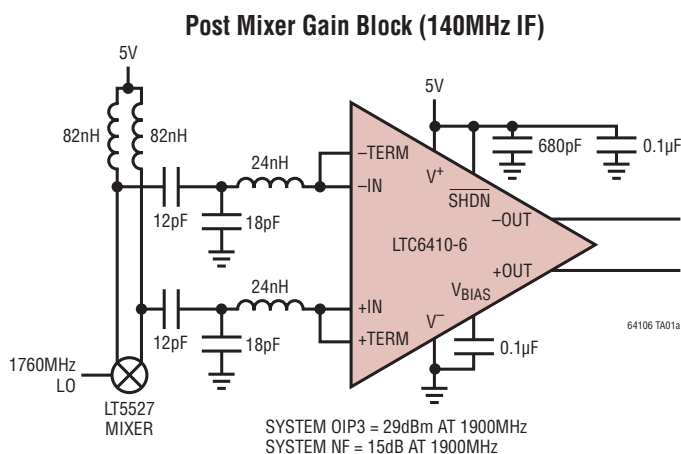

64106 TA01b

64106fa

ABSOLUTE MAXIMUM RATINGS

(Note 1)

Total Supply Voltage (V^+ to V^-)	5.5V
Amplifier Input Current (DC)	
(+IN, -IN, +TERM, -TERM)	$\pm 10\text{mA}$
Amplifier Input Power (AC)	
(+IN, -IN, +TERM, -TERM)	18dBm
Input Current (V_{BIAS} , SHDN)	$\pm 10\text{mA}$
Output Current (+OUT, -OUT)	$\pm 50\text{mA}$
Operating Temperature Range (Note 2)....	-40°C to 85°C
Specified Temperature Range (Note 3)	-40°C to 85°C
Storage Temperature Range.....	-65°C to 150°C
Junction Temperature	150°C
Lead Temperature (Soldering, 10 sec)	300°C

PIN CONFIGURATION

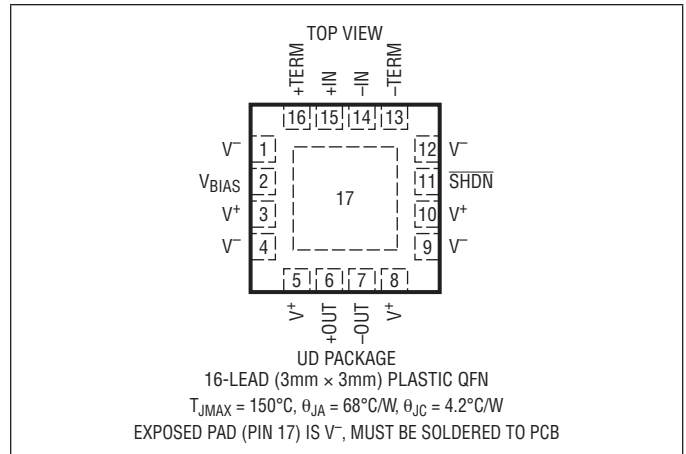

ORDER INFORMATION

LEAD FREE FINISH	TAPE AND REEL	PART MARKING*	PACKAGE DESCRIPTION	TEMPERATURE RANGE (Notes 2, 3)
LTC6410CUD-6#PBF	LTC6410CUD-6#TRPBF	LDBG	16-Lead (3mm x 3mm) Plastic QFN	-40°C to 85°C
LTC6410IUD-6#PBF	LTC6410IUD-6#TRPBF	LDBG	16-Lead (3mm x 3mm) Plastic QFN	-40°C to 85°C

Consult LTC Marketing for parts specified with wider operating temperature ranges. *The temperature grade is identified by a label on the shipping container. Consult LTC Marketing for information on non-standard lead based finish parts.

For more information on lead free part marking, go to: <http://www.linear.com/leadfree/>

For more information on tape and reel specifications, go to: <http://www.linear.com/tapeandreeel/>

3V DC ELECTRICAL CHARACTERISTICS The ● denotes the specifications which apply over the full operating temperature range, otherwise specifications are at $T_A = 25^\circ\text{C}$. $V^+ = 3\text{V}$, $V^- = 0\text{V}$, SHDN = 2V, +IN is shorted to +TERM, -IN is shorted to -TERM, $V_{\text{BIAS}} = 1.5\text{V}$, +IN = -IN = 1.5V, input source resistance (R_S) is 25Ω on each input (50Ω differential), $R_L = 50\Omega$ from +OUT to -OUT, unless otherwise noted. V_{BIAS} is defined as the voltage on the V_{BIAS} pin. V_{OUTCM} is defined as $(+OUT + -OUT)/2$. V_{INCM} is defined as $(+IN + -IN)/2$. V_{INDIFF} is defined as $(+IN - -IN)$. V_{OUTDIFF} is defined as $(+OUT - -OUT)$. See DC test circuit schematic.

SYMBOL	PARAMETER	CONDITIONS	MIN	TYP	MAX	UNITS
G_{DIFF}	Differential Gain (Low Frequency S21)	$V_{\text{INDIFF}} = \pm 0.2\text{V}$	● 5.0	6.0	6.7	dB
			4.7		7.0	dB
TC G_{DIFF}	Differential Gain Temperature Coefficient		●	0.003		dB/ $^\circ\text{C}$
$V_{\text{SWINGDIFF}}$	Differential Output Voltage Swing	$V_{\text{OUTDIFF}}, V_{\text{INDIFF}} = \pm 2\text{V}$	● 2.2	2.8		$V_{\text{P-P}}$ $V_{\text{P-P}}$
V_{SWINGMIN}	Output Swing Low	Single-Ended +OUT, -OUT, $V_{\text{INDIFF}} = \pm 2\text{V}$	●	0.7	0.9	V
					1.0	V
V_{SWINGMAX}	Output Swing High	Single-Ended +OUT, -OUT, $V_{\text{INDIFF}} = \pm 2\text{V}$	● 1.9	2.1		V
				1.8		V
I_{OUT}	Output Current Drive	Short +OUT to -OUT, $V_{\text{INDIFF}} = \pm 2\text{V}$ (Note 4)	● ± 38	± 42		mA
				± 36		mA
V_{OS}	Input Offset Voltage		● -2.0	0.4	2.0	mV
				-3.0	3.0	mV

3V DC ELECTRICAL CHARACTERISTICS The ● denotes the specifications which apply over the full operating temperature range, otherwise specifications are at $T_A = 25^\circ\text{C}$. $V^+ = 3\text{V}$, $V^- = 0\text{V}$, $\text{SHDN} = 2\text{V}$, +IN is shorted to +TERM, -IN is shorted to -TERM, $V_{\text{BIAS}} = 1.5\text{V}$, +IN = -IN = 1.5V, input source resistance (R_S) is 25Ω on each input (50Ω differential), $R_L = 50\Omega$ from +OUT to -OUT, unless otherwise noted. V_{BIAS} is defined as the voltage on the V_{BIAS} pin. V_{OUTCM} is defined as $(+\text{OUT} + -\text{OUT})/2$. V_{INCM} is defined as $(+\text{IN} + -\text{IN})/2$. V_{INDIFF} is defined as $(+\text{IN} - -\text{IN})$. V_{OUTDIFF} is defined as $(+\text{OUT} - -\text{OUT})$. See DC test circuit schematic.

SYMBOL	PARAMETER	CONDITIONS	MIN	TYP	MAX	UNITS
TC V_{OS}	Input Offset Voltage Drift		●	-0.3		$\mu\text{V}/^\circ\text{C}$
V_{OSINCM}	Common Mode Offset Voltage	$V_{\text{OUTCM}} - V_{\text{INCM}}$	●	-40 -50	13 40 50	mV mV
A_V	Internal Voltage Gain			2.7		V/V
I_{VRMIN}	Input Common Mode Voltage Range, (Min)		●		1.0	V
I_{VRMAX}	Input Common Mode Voltage Range, (Max)		●	2.0		V
R_{INDIFF}	Differential Input Resistance	$V_{\text{INDIFF}} = \pm 100\text{mV}$ (Note 4)	●	40 30	58 80 100	Ω Ω
X_{INDIFF}	Differential Input Reactance	$f = 100\text{MHz}$		1		pF
R_{INCM}	Input Common Mode Resistance			1000		Ω
CMRR	Common Mode Rejection Ratio	$V_{\text{BIAS}} = 1.5\text{V}$, +IN = -IN = 1V to 2V, ($\Delta V_{\text{OUTDIFF}}/\text{Gain}$)	●	45	60	dB
R_{ODIFF}	Differential Output Resistance	$V_{\text{OUTDIFF}} = \pm 100\text{mV}$ (Note 4)	●	17 13	22 47	Ω Ω
X_{OUTDIFF}	Differential Output Reactance	$f = 100\text{MHz}$		10		nH
R_{OUTCM}	Common Mode Output Resistance			7		Ω

Bias Voltage Control (V_{BIAS} Pin)

G_{CM}	Common Mode Gain	$V_{\text{BIAS}} = 1.2\text{V}$ to 1.8V (+IN and -IN floating), $\Delta V_{\text{OUTCM}}/(0.6\text{V})$	●	0.7 0.6	0.86 1.0	1.0 1.0	V/V V/V
V_{OCMMIN}	Output Common Mode Voltage Adjustment Range, (Min)		●		1.0	1.2	V
V_{OCMMAX}	Output Common Mode Voltage Adjustment Range, (Max)		●	1.8	2.0		V
V_{OSCM}	Output Common Mode Offset Voltage	$V_{\text{OUTCM}} - V_{\text{BIAS}}$	●	-200 -400	100	300 400	mV mV
R_{VOCM}	V_{BIAS} Input Resistance		●	2.4 2.0	3.0	3.6 4.0	k Ω k Ω
C_{VBIAS}	V_{BIAS} Input Capacitance				3		pF

SHDN Pin

V_{IL}	SHDN Input Low Voltage		●	0.8	1.0		V
V_{IH}	SHDN Input High Voltage		●		1.8	2	V
I_{IL}	SHDN Input Low Current	SHDN = 0.8V	●	-200	-85	0	μA
I_{IH}	SHDN Input High Current	SHDN = 2V	●	-150	-30	0	μA

Power Supply

V_S	Operating Range		●	2.8		5.25	V
I_S	Supply Current		●		104	130 140	mA mA
I_{SSHDN}	Supply Current in Shutdown	SHDN = 0.8V	●		3	5	mA
PSRR	Power Supply Rejection Ratio	$V^+ = 2.8\text{V}$ to 5.25V , $V_{\text{BIAS}} = +\text{IN} = -\text{IN} = V^+/2$	●	73	100		dB

5V DC ELECTRICAL CHARACTERISTICS The ● denotes the specifications which apply over the full operating temperature range, otherwise specifications are at $T_A = 25^\circ\text{C}$. $V^+ = 5\text{V}$, $V^- = 0\text{V}$, $\overline{\text{SHDN}} = 3\text{V}$, +IN is shorted to +TERM, -IN is shorted to -TERM, $V_{\text{INCM}} = V_{\text{BIAS}} = 2.5\text{V}$, +IN = -IN = 2.5V, input source resistance (R_S) is 25Ω on each input (50Ω differential), $R_L = 50\Omega$ from +OUT to -OUT, unless otherwise noted. V_{BIAS} is defined as the voltage on the V_{BIAS} pin. V_{OUTCM} is defined as $(+\text{OUT} + -\text{OUT})/2$. V_{INCM} is defined as $(+\text{IN} + -\text{IN})/2$. V_{INDIFF} is defined as $(+\text{IN} - -\text{IN})$. V_{OUTDIFF} is defined as $(+\text{OUT} - -\text{OUT})$. See DC test circuit schematic.

SYMBOL	PARAMETER	CONDITIONS	MIN	TYP	MAX	UNITS
G_{DIFF}	Differential Gain (Low Frequency S21)	$V_{\text{IN}} = \pm 0.2\text{V}$	● 5 4.7	6.1	6.7 7.0	dB dB
$V_{\text{SWINGDIFF}}$	Differential Output Voltage Swing	$V_{\text{OUTDIFF}}, V_{\text{IN}} = \pm 4\text{V}$	● 4.1 3.5	4.8		$V_{\text{P-P}}$ $V_{\text{P-P}}$
V_{SWINGMIN}	Output Swing Low	Single-Ended +OUT, -OUT, $V_{\text{IN}} = \pm 4\text{V}$	●	1.1	1.4 1.6	V V
V_{SWINGMAX}	Output Swing High	Single-Ended +OUT, -OUT, $V_{\text{IN}} = \pm 4\text{V}$	● 3.2 3.0	3.5		V V
I_S	Supply Current		●	125	150 160	mA mA

SHDN Pin

V_{IL}	SHDN Input Low Voltage		● 1.8	2.0		V
V_{IH}	SHDN Input High Voltage		●	2.8	3	V
I_{IL}	SHDN Input Low Current	SHDN = 1.8V	● -300	-110	0	μA
I_{IH}	SHDN Input High Current	SHDN = 3V	● -200	-60	0	μA

AC ELECTRICAL CHARACTERISTICS The ● denotes the specifications which apply over the full operating temperature range, otherwise specifications are at $T_A = 25^\circ\text{C}$. $V^+ = 3\text{V}$, $V^- = 0\text{V}$, $\overline{\text{SHDN}} = 2\text{V}$, +IN is shorted to +TERM, -IN is shorted to -TERM, $V_{\text{INCM}} = V_{\text{BIAS}} = 1.5\text{V}$, input source resistance (R_S) is 25Ω on each input (50Ω differential), $R_L = 50\Omega$ from +OUT to -OUT, +IN and -IN are AC-coupled, unless otherwise noted. V_{BIAS} is defined as the voltage on the V_{BIAS} pin. V_{OUTCM} is defined as $(+\text{OUT} + -\text{OUT})/2$. V_{INCM} is defined as $(+\text{IN} + -\text{IN})/2$. V_{INDIFF} is defined as $(+\text{IN} - -\text{IN})$. V_{OUTDIFF} is defined as $(+\text{OUT} - -\text{OUT})$.

SYMBOL	PARAMETER	CONDITIONS	MIN	TYP	MAX	UNITS
-3dBBW	-3dB Bandwidth	$V_{\text{INDIFF}} = -10\text{dBm}$	1	1.4		GHz
0.1dBBW	Bandwidth for 0.1dB Flatness	$V_{\text{INDIFF}} = -10\text{dBm}$		150		MHz
0.5dBBW	Bandwidth for 0.5dB Flatness	$V_{\text{INDIFF}} = -10\text{dBm}$		300		MHz
SR	Slew Rate			1.5		V/ns
t_s	1% Settling Time	1% Settling for a $1V_{\text{P-P}}$ V_{OUTDIFF} Step		3		ns
t_{ON}	Turn-On Time	SHDN = 0V to 3V, +OUT and -OUT Within 10% of Final Values		30		ns
t_{OFF}	Turn-Off Time	SHDN = 3V to 0V, +OUT and -OUT Within 10% of Final Values		30		ns

Common Mode Voltage Control (V_{BIAS} Pin)

-3dBBWCM	Common Mode Small-Signal -3dB Bandwidth	$0.2V_{\text{P-P}}$ at V_{BIAS} , Measured V_{OUTCM}		1		GHz
SRCM	Common Mode Slew Rate			100		V/ μs

Noise/Harmonic Performance Input/Output Characteristics

10MHz Signal

HD2	Second Harmonic Distortion	$V_{\text{OUTDIFF}} = 0\text{dBm}$		-85		dBc
HD3	Third Harmonic Distortion	$V_{\text{OUTDIFF}} = 0\text{dBm}$		-71		dBc

AC ELECTRICAL CHARACTERISTICS The ● denotes the specifications which apply over the full operating temperature range, otherwise specifications are at $T_A = 25^\circ\text{C}$. $V^+ = 3\text{V}$, $V^- = 0\text{V}$, $\text{SHDN} = 2\text{V}$, $+\text{IN}$ is shorted to $+\text{TERM}$, $-\text{IN}$ is shorted to $-\text{TERM}$, $V_{\text{INCM}} = V_{\text{BIAS}} = 1.5\text{V}$, input source resistance (R_S) is 25Ω on each input (50Ω differential), $R_L = 50\Omega$ from $+\text{OUT}$ to $-\text{OUT}$, $+\text{IN}$ and $-\text{IN}$ are AC-coupled, unless otherwise noted. V_{BIAS} is defined as the voltage on the V_{BIAS} pin. V_{OUTCM} is defined as $(+\text{OUT} + -\text{OUT})/2$. V_{INCM} is defined as $(+\text{IN} + -\text{IN})/2$. V_{INDIFF} is defined as $(+\text{IN} - -\text{IN})$. V_{OUTDIFF} is defined as $(+\text{OUT} - -\text{OUT})$.

SYMBOL	PARAMETER	CONDITIONS	MIN	TYP	MAX	UNITS
IM3	Third Order Intermodulated Distortion	$F1 = 9.5\text{MHz}$, $F2 = 10.5\text{MHz}$, $V_{\text{OUTDIFF}} = 0\text{dBm/Tone}$		-72		dBc
		$F1 = 9.5\text{MHz}$, $F2 = 10.5\text{MHz}$, $V_{\text{OUTDIFF}} = -5\text{dBm/Tone}$		-81		dBc
		$F1 = 9.5\text{MHz}$, $F2 = 10.5\text{MHz}$, $V_{\text{OUTDIFF}} = 0\text{dBm/Tone}$, $V_{\text{CC}} = 5\text{V}$, $V_{\text{BIAS}} = 2.5\text{V}$, $\text{SHDN} = 3\text{V}$		-66		dBc
OIP3	Output Third-Order Intercept	$F1 = 9.5\text{MHz}$, $F2 = 10.5\text{MHz}$, $V_{\text{OUTDIFF}} = 0\text{dBm/Tone}$		36		dBm
		$F1 = 9.5\text{MHz}$, $F2 = 10.5\text{MHz}$, $V_{\text{OUTDIFF}} = -5\text{dBm/Tone}$		36		dBm
		$F1 = 9.5\text{MHz}$, $F2 = 10.5\text{MHz}$, $V_{\text{OUTDIFF}} = 0\text{dBm/Tone}$, $V_{\text{CC}} = 5\text{V}$, $V_{\text{BIAS}} = 2.5\text{V}$, $\text{SHDN} = 3\text{V}$		33		dBm
P1dB	Output 1dB Compression Point			12.8		dBm
NF	Noise Figure	$Z_{\text{IN}} = 50\Omega$ (Note 5)		11		dB
		$Z_{\text{IN}} = 200\Omega$		8		dB

70MHz Signal

HD2	Second Harmonic Distortion	$V_{\text{OUTDIFF}} = 0\text{dBm}$		-85		dBc
HD3	Third Harmonic Distortion	$V_{\text{OUTDIFF}} = 0\text{dBm}$		-69		dBc
IM3	Third Order Intermodulated Distortion	$F1 = 69.5\text{MHz}$, $F2 = 70.5\text{MHz}$, $V_{\text{OUTDIFF}} = 0\text{dBm/Tone}$		-72		dBc
		$F1 = 69.5\text{MHz}$, $F2 = 70.5\text{MHz}$, $V_{\text{OUTDIFF}} = -5\text{dBm/Tone}$		-79		dBc
		$F1 = 69.5\text{MHz}$, $F2 = 70.5\text{MHz}$, $V_{\text{OUTDIFF}} = 0\text{dBm/Tone}$, $V_{\text{CC}} = 5\text{V}$, $V_{\text{BIAS}} = 2.5\text{V}$, $\text{SHDN} = 3\text{V}$		-72		dBc
OIP3	Output Third-Order Intercept	$F1 = 69.5\text{MHz}$, $F2 = 70.5\text{MHz}$, $V_{\text{OUTDIFF}} = 0\text{dBm/Tone}$		36		dBm
		$F1 = 69.5\text{MHz}$, $F2 = 70.5\text{MHz}$, $V_{\text{OUTDIFF}} = -5\text{dBm/Tone}$		35		dBm
		$F1 = 69.5\text{MHz}$, $F2 = 70.5\text{MHz}$, $V_{\text{OUTDIFF}} = 0\text{dBm/Tone}$, $V_{\text{CC}} = 5\text{V}$, $V_{\text{BIAS}} = 2.5\text{V}$, $\text{SHDN} = 3\text{V}$		36		dBm
P1dB	Output 1dB Compression Point			12.8		dBm
NF	Noise Figure	$Z_{\text{IN}} = 50\Omega$ (Note 5)		11		dB
		$Z_{\text{IN}} = 200\Omega$		8		dB

140MHz Signal

HD2	Second Harmonic Distortion	$V_{\text{OUTDIFF}} = 0\text{dBm}$		-80		dBc
HD3	Third Harmonic Distortion	$V_{\text{OUTDIFF}} = 0\text{dBm}$		-62		dBc
IM3	Third Order Intermodulated Distortion	$F1 = 139.5\text{MHz}$, $F2 = 140.5\text{MHz}$, $V_{\text{OUTDIFF}} = 0\text{dBm/Tone}$		-62		dBc
		$F1 = 139.5\text{MHz}$, $F2 = 140.5\text{MHz}$, $V_{\text{OUTDIFF}} = -5\text{dBm/Tone}$		-70		dBc
		$F1 = 139.5\text{MHz}$, $F2 = 140.5\text{MHz}$, $V_{\text{OUTDIFF}} = 0\text{dBm/Tone}$, $V_{\text{CC}} = 5\text{V}$, $V_{\text{BIAS}} = 2.5\text{V}$, $\text{SHDN} = 3\text{V}$		-66		dBc
		$F1 = 130\text{MHz}$, $F2 = 150\text{MHz}$, $V_{\text{OUTDIFF}} = 0\text{dBm/Tone}$, $V_{\text{CC}} = 5\text{V}$, $V_{\text{BIAS}} = 2.5\text{V}$, $\text{SHDN} = 3\text{V}$		-66	-56	dBc
OIP3	Output Third-Order Intercept	$F1 = 139.5\text{MHz}$, $F2 = 140.5\text{MHz}$, $V_{\text{OUTDIFF}} = 0\text{dBm/Tone}$		31		dBm
		$F1 = 139.5\text{MHz}$, $F2 = 140.5\text{MHz}$, $V_{\text{OUTDIFF}} = -5\text{dBm/Tone}$		30		dBm
		$F1 = 139.5\text{MHz}$, $F2 = 140.5\text{MHz}$, $V_{\text{OUTDIFF}} = 0\text{dBm/Tone}$, $V_{\text{CC}} = 5\text{V}$, $V_{\text{BIAS}} = 2.5\text{V}$, $\text{SHDN} = 3\text{V}$		33		dBm
		$F1 = 130\text{MHz}$, $F2 = 150\text{MHz}$, $V_{\text{OUTDIFF}} = 0\text{dBm/Tone}$, $V_{\text{CC}} = 5\text{V}$, $V_{\text{BIAS}} = 2.5\text{V}$, $\text{SHDN} = 3\text{V}$		28	33	dBm
P1dB	Output 1dB Compression Point			12.8		dBm

AC ELECTRICAL CHARACTERISTICS The ● denotes the specifications which apply over the full operating temperature range, otherwise specifications are at $T_A = 25^\circ\text{C}$. $V^+ = 3\text{V}$, $V^- = 0\text{V}$, $\text{SHDN} = 2\text{V}$, $+IN$ is shorted to $+TERM$, $-IN$ is shorted to $-TERM$, $V_{INCM} = V_{BIAS} = 1.5\text{V}$, input source resistance (R_S) is 25Ω on each input (50Ω differential), $R_L = 50\Omega$ from $+OUT$ to $-OUT$, $+IN$ and $-IN$ are AC-coupled, unless otherwise noted. V_{BIAS} is defined as the voltage on the V_{BIAS} pin. V_{OUTCM} is defined as $(+OUT + -OUT)/2$. V_{INCM} is defined as $(+IN + -IN)/2$. V_{INDIFF} is defined as $(+IN - -IN)$. $V_{OUTDIFF}$ is defined as $(+OUT - -OUT)$.

SYMBOL	PARAMETER	CONDITIONS	MIN	TYP	MAX	UNITS
NF	Noise Figure	$Z_{IN} = 50\Omega$ (Note 5)		11		dB
		$Z_{IN} = 200\Omega$		7		dB

240MHz Signal

HD2	Second Harmonic Distortion	$V_{OUTDIFF} = 0\text{dBm}$		-66		dBc
HD3	Third Harmonic Distortion	$V_{OUTDIFF} = 0\text{dBm}$		-52		dBc
IM3	Third Order Intermodulated Distortion	$F1 = 239.5\text{MHz}$, $F2 = 240.5\text{MHz}$, $V_{OUTDIFF} = 0\text{dBm/Tone}$		-54		dBc
		$F1 = 239.5\text{MHz}$, $F2 = 240.5\text{MHz}$, $V_{OUTDIFF} = -5\text{dBm/Tone}$		-63		dBc
		$F1 = 239.5\text{MHz}$, $F2 = 240.5\text{MHz}$, $V_{OUTDIFF} = 0\text{dBm/Tone}$, $V_{CC} = 5\text{V}$, $V_{BIAS} = 2.5\text{V}$, $\text{SHDN} = 3\text{V}$		-64		dBc
OIP3	Output Third-Order Intercept	$F1 = 239.5\text{MHz}$, $F2 = 240.5\text{MHz}$, $V_{OUTDIFF} = 0\text{dBm/Tone}$		27		dBm
		$F1 = 239.5\text{MHz}$, $F2 = 240.5\text{MHz}$, $V_{OUTDIFF} = -5\text{dBm/Tone}$		27		dBm
		$F1 = 239.5\text{MHz}$, $F2 = 240.5\text{MHz}$, $V_{OUTDIFF} = 0\text{dBm/Tone}$, $V_{CC} = 5\text{V}$, $V_{BIAS} = 2.5\text{V}$, $\text{SHDN} = 3\text{V}$		32		dBm
P1dB	Output 1dB Compression Point			12.8		dBm
NF	Noise Figure	$Z_{IN} = 50\Omega$ (Note 5)		11		dB
		$Z_{IN} = 200\Omega$		8		dB

380MHz Signal

HD2	Second Harmonic Distortion	$V_{OUTDIFF} = 0\text{dBm}$		-57		dBc
HD3	Third Harmonic Distortion	$V_{OUTDIFF} = 0\text{dBm}$		-45		dBc
IM3	Third Order Intermodulated Distortion	$F1 = 379.5\text{MHz}$, $F2 = 380.5\text{MHz}$, $V_{OUTDIFF} = 0\text{dBm/Tone}$		-51		dBc
		$F1 = 379.5\text{MHz}$, $F2 = 380.5\text{MHz}$, $V_{OUTDIFF} = -5\text{dBm/Tone}$		-64		dBc
		$F1 = 379.5\text{MHz}$, $F2 = 380.5\text{MHz}$, $V_{OUTDIFF} = 0\text{dBm/Tone}$, $V_{CC} = 5\text{V}$, $V_{BIAS} = 2.5\text{V}$, $\text{SHDN} = 3\text{V}$		-60		dBc
OIP3	Output Third-Order Intercept	$F1 = 379.5\text{MHz}$, $F2 = 380.5\text{MHz}$, $V_{OUTDIFF} = 0\text{dBm/Tone}$		26		dBm
		$F1 = 379.5\text{MHz}$, $F2 = 380.5\text{MHz}$, $V_{OUTDIFF} = -5\text{dBm/Tone}$		27		dBm
		$F1 = 379.5\text{MHz}$, $F2 = 380.5\text{MHz}$, $V_{OUTDIFF} = 0\text{dBm/Tone}$, $V_{CC} = 5\text{V}$, $V_{BIAS} = 2.5\text{V}$, $\text{SHDN} = 3\text{V}$		30		dBm
P1dB	Output 1dB Compression Point			10.8		dBm
NF	Noise Figure	$Z_{IN} = 50\Omega$ (Note 5)		12		dB
		$Z_{IN} = 200\Omega$		8		dB

Note 1: Stresses beyond those listed under Absolute Maximum Ratings may cause permanent damage to the device. Exposure to any Absolute Maximum Rating condition for extended periods may affect device reliability and lifetime.

Note 2: The LTC6410C-6/LTC6410I-6 is guaranteed functional over the operating temperature range of -40°C to 85°C .

Note 3: The LTC6410C-6 is guaranteed to meet specified performance from 0°C to 70°C . It is designed, characterized and expected to meet specified performance from -40°C and 85°C but is not tested or QA

sampled at these temperatures. The LTC6410I-6 is guaranteed to meet specified performance from -40°C to 85°C .

Note 4: This parameter is pulse tested.

Note 5: e_n can be calculated from $Z_{IN} = 50\Omega$ NF with the formula:

$$e_n = \sqrt{(10^{NF} - 1)4kT50}$$

where

k = Boltzmann's constant and
T = absolute temperature

TYPICAL PERFORMANCE CHARACTERISTICS

Output Third Order Intercept vs Frequency

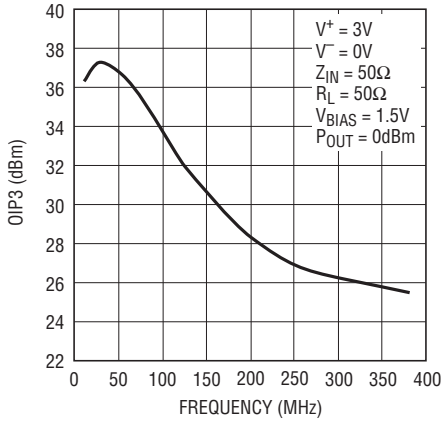

64106 G01

Output Third Order Intercept vs Frequency ($Z_{IN} = 200\Omega$)

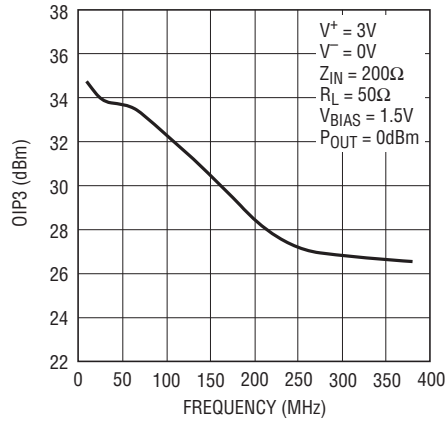

64106 G02

Third Order Intermodulation Distortion vs Frequency vs Power

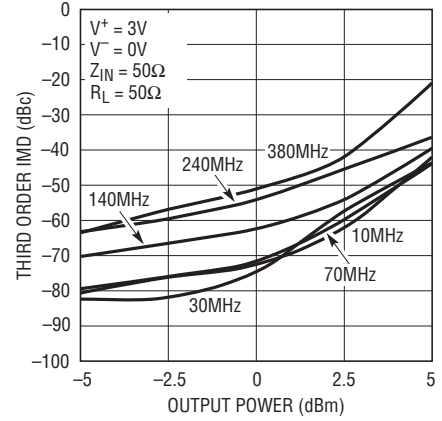

64106 G03

Third Order Intermodulation Distortion vs Frequency vs Power ($Z_{IN} = 200\Omega$)

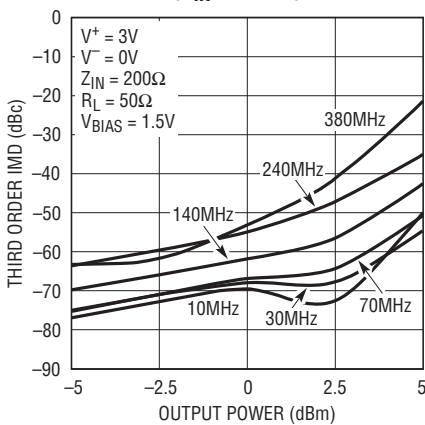

64106 G04

Third Order Intermodulation Distortion vs Temperature

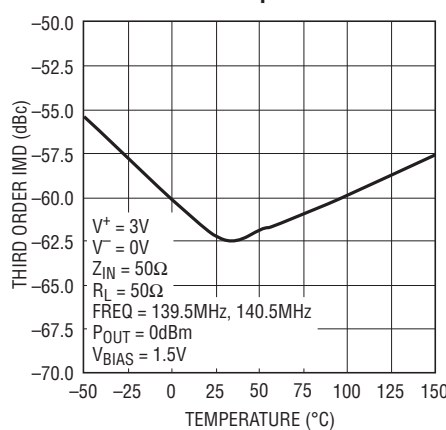

64106 G05

Output 1dB Compression vs Frequency

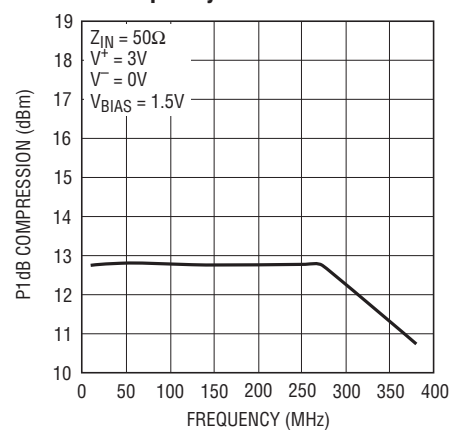

64106 G06

Output Third Order Intercept vs Frequency

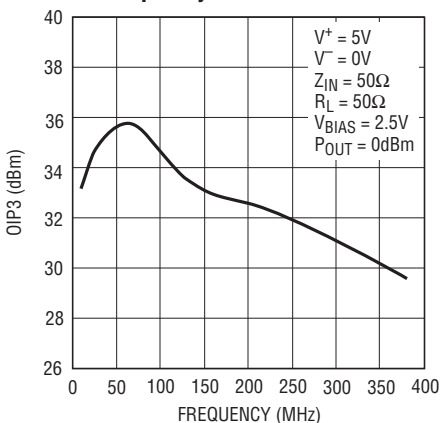

64106 G07

Output 1dB Compression vs Frequency

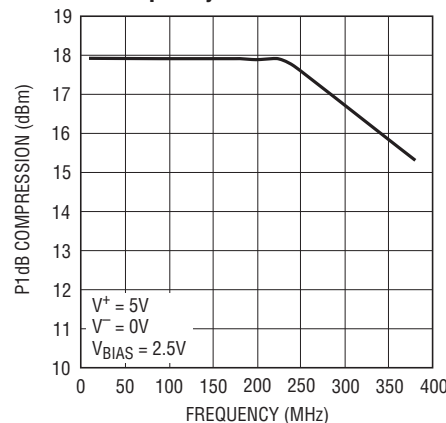

64106 G08

Distortion vs Common Mode Voltage

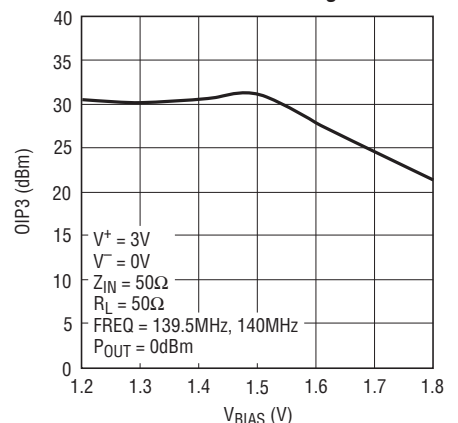

64106 G09

TYPICAL PERFORMANCE CHARACTERISTICS

Differential Gain vs Frequency (S21)

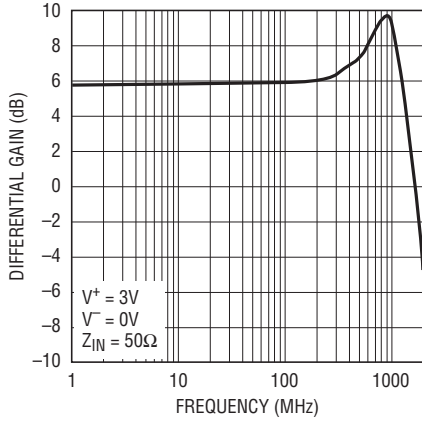

64106 G10

Differential Input Return Loss vs Frequency (S11)

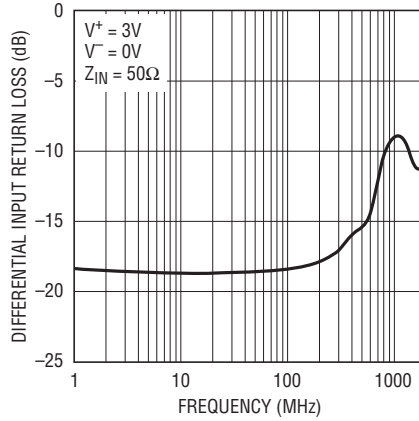

64106 G11

Differential Output Return Loss vs Frequency (S22)

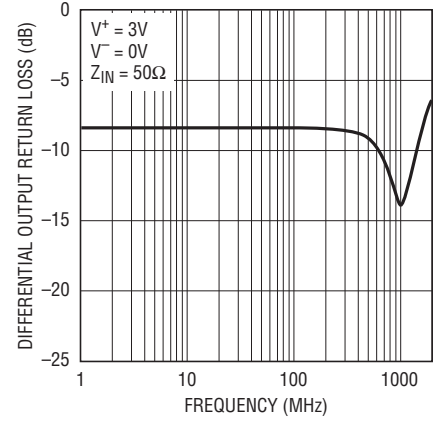

64106 G12

Differential Reverse Isolation vs Frequency (S12)

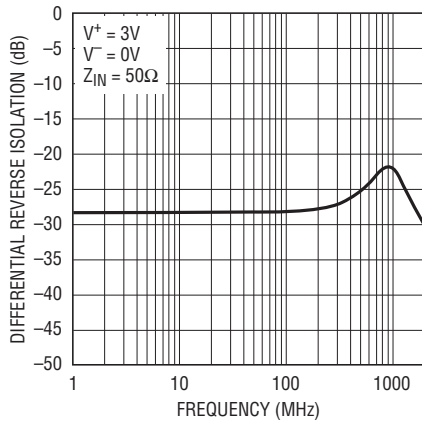

64106 G13

Differential Input Return Loss vs Frequency on a Smith Chart (S11)

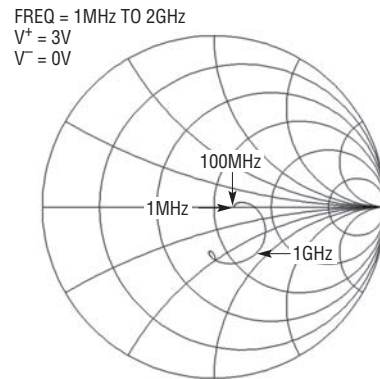

64106 G14

Differential Output Return Loss vs Frequency on a Smith Chart (S22)

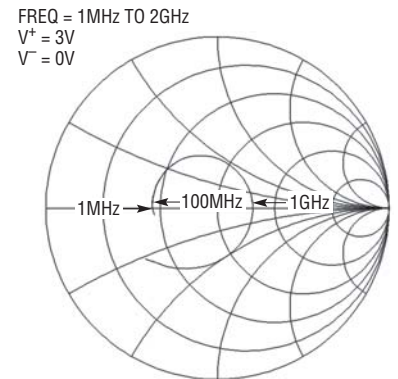

64106 G15

Small-Signal Transient

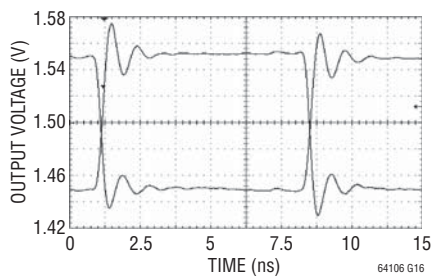

64106 G16

Large-Signal Transient

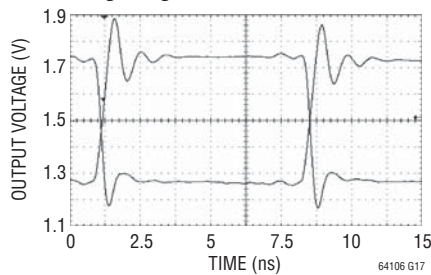

64106 G17

Overdrive Recovery

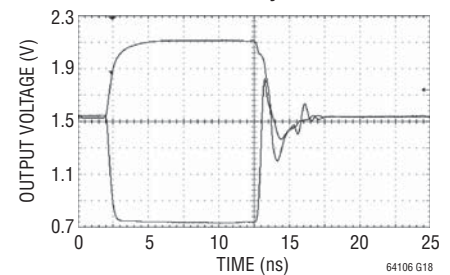

64106 G18

TYPICAL PERFORMANCE CHARACTERISTICS

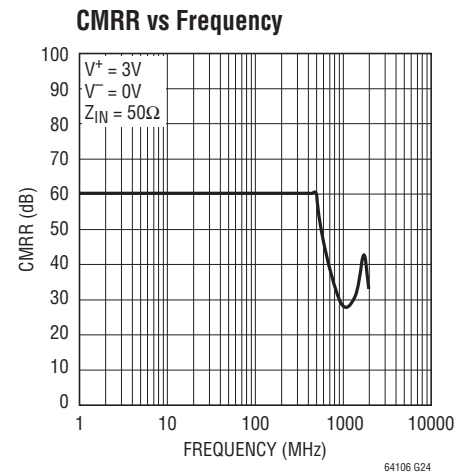
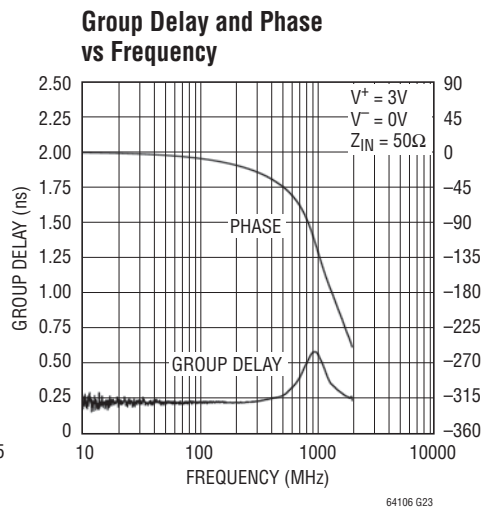
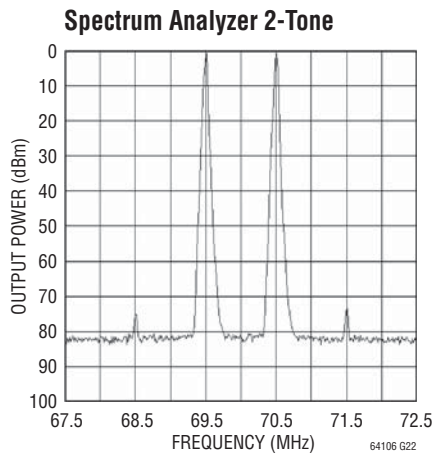
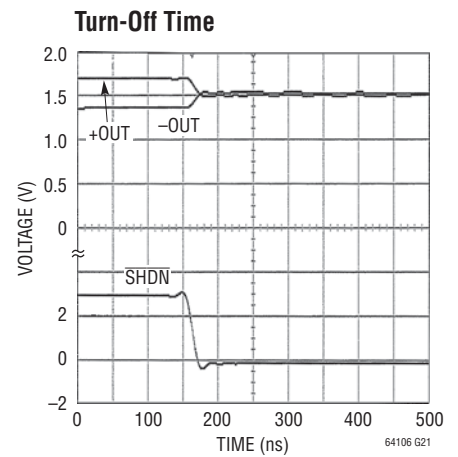
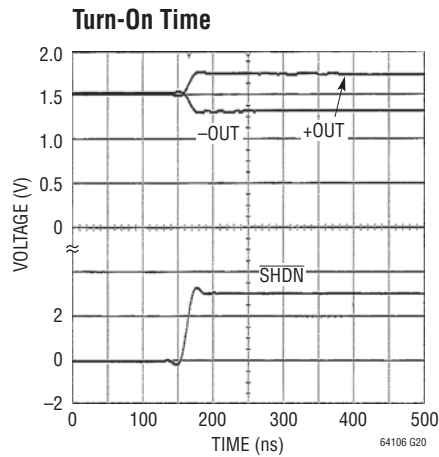
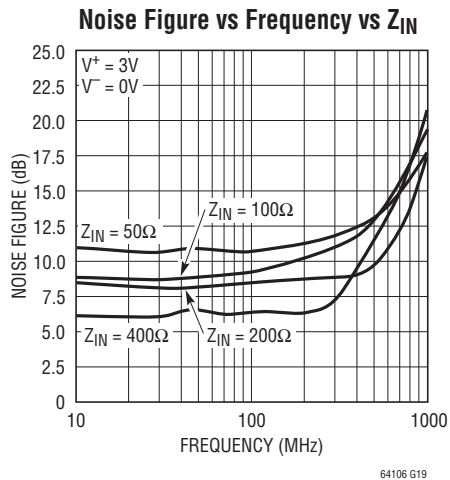

DC TEST CIRCUIT SCHEMATIC

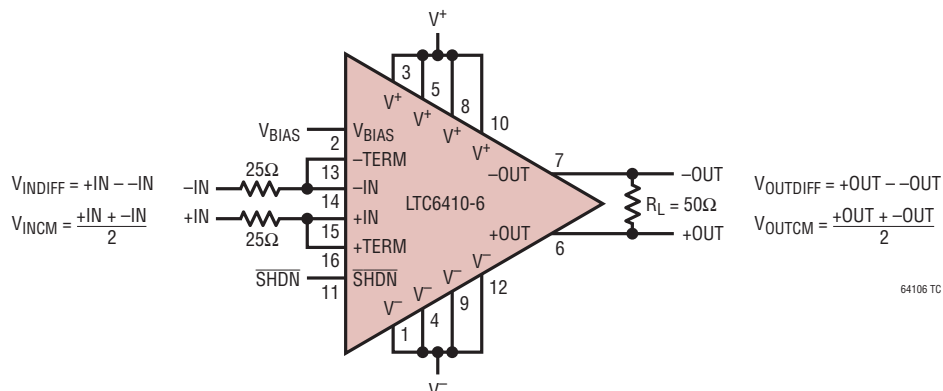

PIN FUNCTIONS

V⁻ (Pins 1, 4, 9, 12, 17): Negative Power Supply (Normally Tied to Ground). All 5 pins must be tied to the same voltage. V⁻ may be tied to a voltage other than ground as long as the voltage between V⁺ and V⁻ is 2.8V to 5.5V. If the V⁻ pins are not tied to ground, bypass each with 680pF and 0.1μF capacitors as close to the package as possible.

V_{BIAS} (Pin 2): This pin sets the input and output common mode voltage by driving the +IN and -IN through a buffer with a high output resistance of 1k. If the part is AC-coupled at the input, the V_{BIAS} will set the V_{INCM} and therefore the V_{OUTCM} voltage. If the part is DC-coupled at the input, V_{BIAS} should be left floating. Internal resistors bias V_{BIAS} to 1.4V on a 3V supply.

V⁺ (Pins 3, 5, 8, 10): Positive Power Supply. All 4 pins must be tied to the same voltage. Split supplies are possible as long as the voltage between V⁺ and V⁻ is 2.8V to 5.5V. Bypass capacitors of 680pF and 0.1μF as close to the part as possible should be used between supplies.

+OUT, -OUT (Pins 6, 7): Outputs. These pins each have internal series termination resistors forming a differential output resistance.

SHDN (Pin 11): This pin is internally pulled high by a typically 30k resistor to V⁺. By pulling this pin low the supply current will be reduced to typically 3mA. See DC Electrical Characteristics table for the specific logic levels.

-TERM (Pin 13): Negative Input Termination. When tied directly to -IN, it provides an active 50Ω differential termination when +TERM is also tied directly to +IN.

-IN (Pin 14): Negative Input. This pin is normally tied to -TERM, the input termination pin. If AC-coupled, this pin will self bias by V_{BIAS}.

+IN (Pin 15): Positive Input. This pin is normally tied to +TERM, the input termination pin. If AC-coupled, this pin will self bias by V_{BIAS}.

+TERM (Pin 16): Positive Input Termination. When tied directly to +IN, it provides an active 50Ω differential termination when -TERM is also tied directly to -IN.

Exposed Pad (Pin 17): V⁻. The Exposed Pad must be soldered to the PCB metal.

BLOCK DIAGRAM

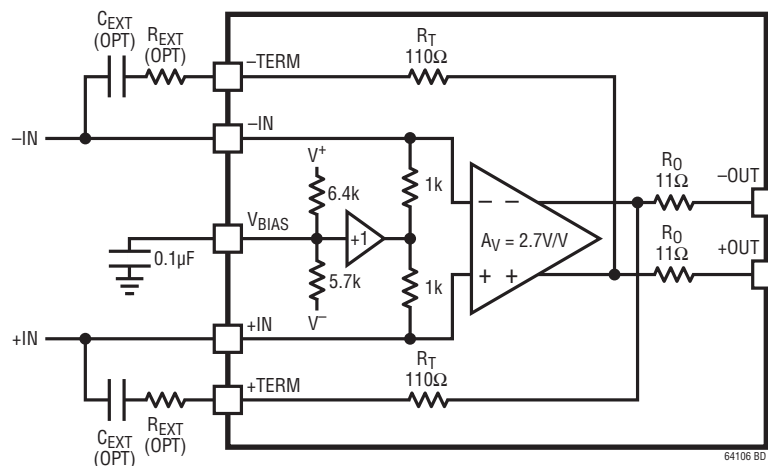

APPLICATIONS INFORMATION

Introduction

The LTC6410-6 is a low noise differential high speed amplifier. By default, the LTC6410-6 has 6dB voltage gain and is designed to operate with 50Ω differential input and output impedances. By changing (R_{EXT}), alternative configurations provide input resistances of up to 400Ω , with correspondingly lower noise figure and higher power gain. The Block Diagram shows the basic circuit along with key external components while Table 1 provides configuration information. If the input is AC-coupled, the V_{BIAS} pin sets the input common mode voltage and therefore the output common mode voltage.

Input Impedance

LTC6410-6 has been designed with very flexible input termination circuitry. By default, with the termination pins connected directly to the inputs, the input impedance is 58Ω , see the Block Diagram. Internally, there is 110Ω between each input and the opposite output (R_T). Dividing the resistor by the internal noise gain of $2.7 + 1 = 3.7$, 29.5Ω input impedance is created (59Ω differential). In parallel with the $2k$ common mode resistance, a total of 58Ω differential input impedance is achieved. This method of termination is used to provide lower noise figure through the use of feedback which reduces the effective noise of the termination resistor. By adding additional resistance in series with the termination pins, higher input impedances can be obtained (see Table 1). The optimum impedance for minimizing the noise figure of the LTC6410-6 is close to 400Ω . Because the amplifier is inherently a voltage amplifier, the difference between the impedance at the input and the output adds additional power gain as can be seen in Table 1. These higher impedance levels can be useful in interfacing with active mixers which can have output impedance of 400Ω and beyond.

Input and Output Common Mode Bias

The LTC6410-6 is internally self-biased through the V_{BIAS} pin (see the Block Diagram). Therefore the LTC6410-6 can be AC-coupled with no external biasing circuitry. The

output will have approximately the same common mode voltage as the input.

In the case of a DC-coupled input connection, the input DC common mode voltage will also set the output common mode voltage. Note that a voltage divider is formed between the V_{BIAS} buffer output and the DC input source impedance.

The V_{BIAS} pin has an internal voltage divider which will self bias to approximately $1.4V$ on a $3V$ supply ($0.47 \cdot V_{SUPPLY}$). An external capacitor of $0.1\mu F$ to ground is recommended to bypass the pin. The resistance of the pin is $3k$. See Distortion vs Common Mode graph.

For increased common mode accuracy, the +TERM and -TERM pins can be AC-coupled to the inputs with capacitors (C_{EXT}). This coupling prevents the feedback from the termination resistance from creating additional DC common mode voltage error. The G_{CM} and V_{OSCM} of the DC Electrical Characteristics table reflect the less accurate DC-coupled scenario.

The termination inputs are part of a high speed feedback loop. The physical length of the termination loop (R_{EXT} and C_{EXT}) must be minimized to maintain stability and minimize gain peaking.

Gain

Internally, the LTC6410-6 has a voltage gain of $2.7V/V$. The default source and load resistances in most of the data sheet are assumed to be 50Ω differential. Due to the input and output resistance of the LTC6410-6 being 58Ω and 22Ω respectively, the overall voltage gain in a 50Ω system is 6dB ($2V/V$). Other source and load resistances will produce different gains due to the resistive dividers. Figure 1 is a system diagram for calculating gain.

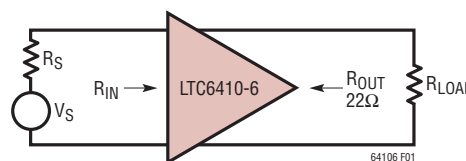

Figure 1

APPLICATIONS INFORMATION

Therefore the differential voltage gain can be calculated as follows:

$$\text{Voltage Gain} = 2 \cdot \frac{R_{IN}}{R_{IN} + R_S} \cdot 2.7 \cdot \frac{R_L}{R_L + R_{OUT}}$$

The following is an example of the 50Ω gain calculation:

$$\begin{aligned} \text{Voltage Gain} &= 2 \cdot \frac{58}{58+50} \cdot 2.7 \cdot \frac{50}{50+22} \\ &= 2.0\text{V/V} = 6.0\text{dB} \end{aligned}$$

The part also can be used with different input impedances providing no additional voltage gain, but a higher power gain.

For example, the calculation for a 100Ω input impedance shows the effect of an impedance conversion. The voltage gain is calculated as follows:

$$\begin{aligned} \text{Voltage Gain} &= 2 \cdot \frac{83}{83+100} \cdot 2.7 \cdot \frac{50}{50+22} \\ &= 1.7\text{V/V} = 4.6\text{dB} \end{aligned}$$

However the power gain is:

$$\begin{aligned} \text{Power Gain} &= \left(2 \cdot \frac{83}{83+100} \cdot 2.7 \cdot \frac{50}{50+22} \cdot \sqrt{2} \right)^2 \\ &= 5.8\text{mW/mW} = 7.6\text{dB} \end{aligned}$$

Output Impedance

The LTC6410-6 is designed to drive a differential load of 50Ω with a total differential output resistance of 22Ω. While the LTC6410-6 can source and sink approximately 50mA, large DC output current should be avoided. To test the part on traditional 50Ω test equipment, AC coupling or balun transformers (or both) may be necessary at the input and output.

Supply Rails

Inductance in the supply path can severely effect the performance of the LTC6410-6. Therefore it is recommended that low inductance bypass capacitors are installed very close to the part. 680pF and 0.1μF sized capacitors are recommended. Additionally, the exposed pad of the part must be connected to V⁻ for low inductance and low thermal resistance. Failure to provide a low impedance supply at high frequencies can cause oscillations and increased distortion.

SHDN

The SHDN pin self-biases to V⁺ through a 30k resistor. The pin must be pulled below 0.8V in order to shut down the part.

Applications Circuits

The graphs on the following page are examples of the four differential input resistances used on the DC1103A demo board with balun transformers for interfacing with the 50Ω single-ended measurement equipment.

Table 1. Input Impedance

DIFFERENTIAL SOURCE RESISTANCE (Ω) (R _S)	EXTERNAL TERMINATION RESISTOR (Ω) (R _{EXT})	EFFECTIVE DIFFERENTIAL INPUT IMPEDANCE (Ω) (R _{IN})	DIFFERENTIAL LOAD RESISTANCE (Ω)	OUTPUT RESISTANCE (Ω)	POWER GAIN (dB)	VOLTAGE GAIN (SOURCE AND LOAD RESISTANCE AS STATED) (V/V)	NF AT 10MHz (dB)
50	0	58	50	22	6.0	2.0	11
100	49.9	83	50	22	7.6	1.7	9
200	249	177	50	22	10.9	1.8	7
400	750	377	50	22	14.2	1.8	6
2000	Open	2000	50	22	21.5	1.9	-

APPLICATIONS INFORMATION

$Z_{IN} = 50\Omega$, T1 = ETC1-1-13, T2 = ETC1-1-13

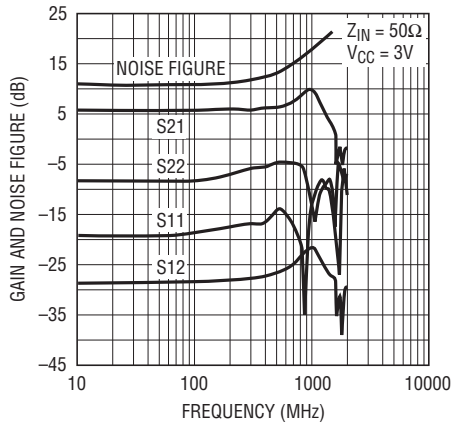
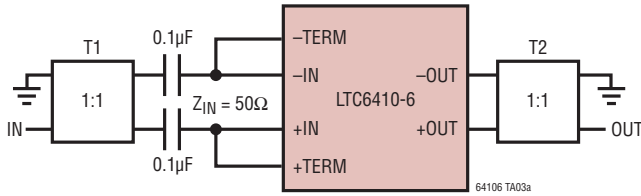

64106 TA02b

$Z_{IN} = 100\Omega$, T1 = WBC2-1TL, T2 = ETC1-1-13

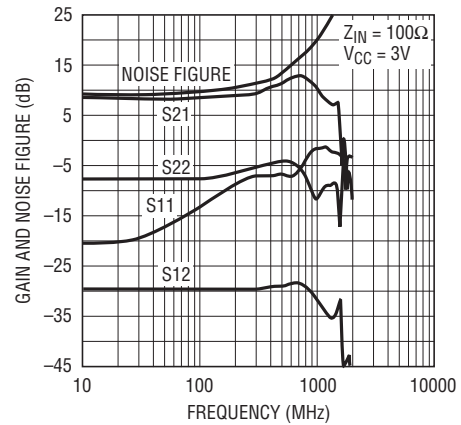
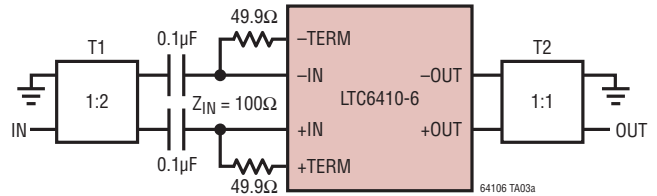

64106 TA03b

$Z_{IN} = 200\Omega$, T1 = WBC4-14L, T2 = ETC1-1-13

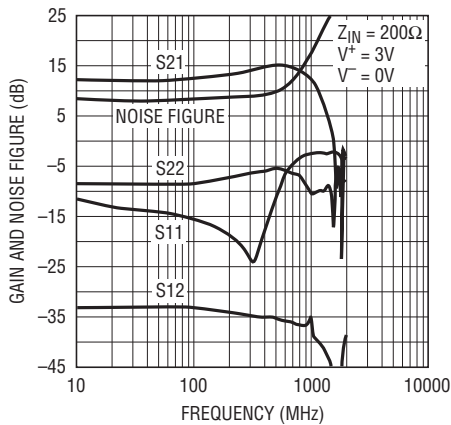
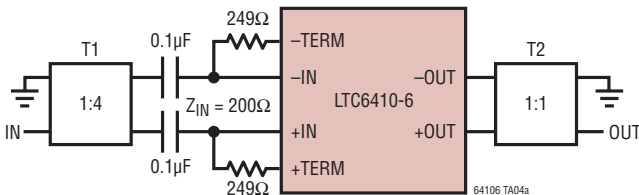

64106 TA04b

$Z_{IN} = 400\Omega$, T1 = WBC8-1L, T2 = ETC1-1-13

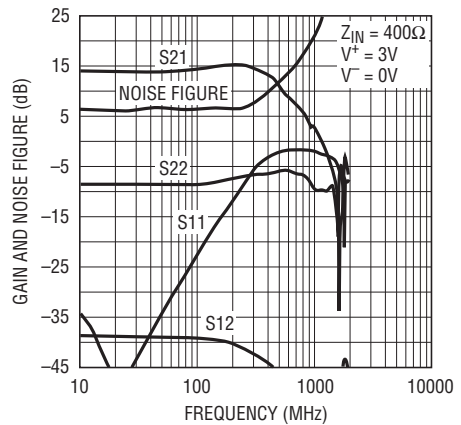
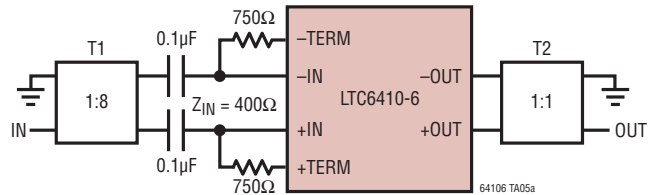

64106 TA05b

APPLICATIONS INFORMATION

Demoboard DC1103A Top Silkscreen

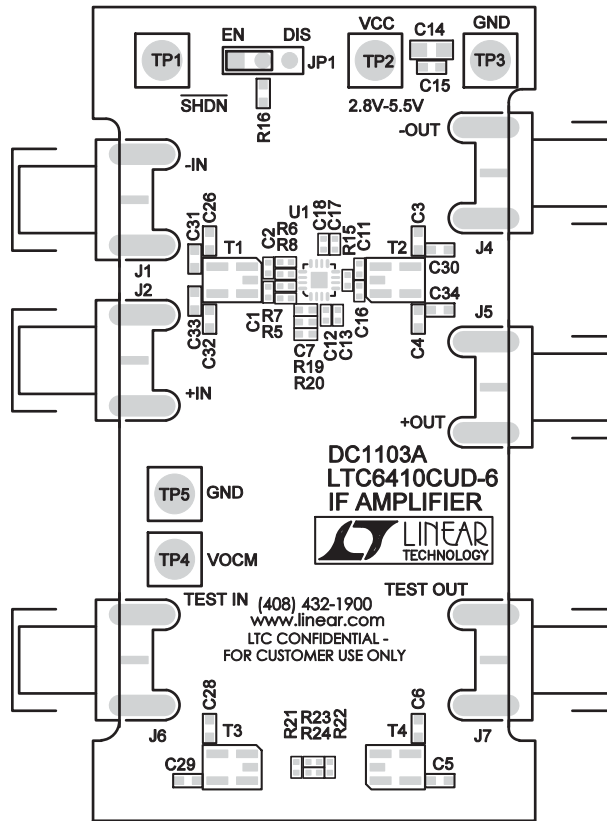

TYPICAL APPLICATION

SAW Filter Application

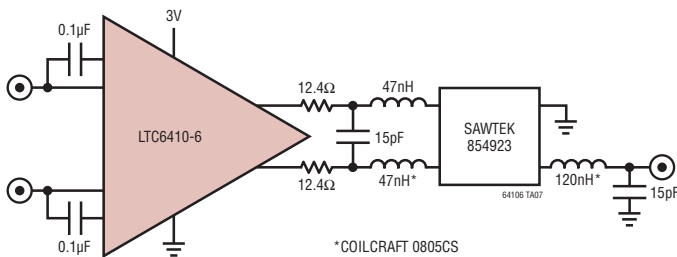

The schematic above shows a typical signal chain application with the LTC6410-6 in combination with a 140MHz center frequency 24MHz bandwidth SAW filter. Without the LTC6410-6, the attenuation of the SAW would be -11.5dB . The networks between the LTC6410-6 and the SAW filter, and after the SAW filter are for proper impedance matching.

The differential output of the LTC6410-6 allows differential driving of the SAW filter without the need for a transformer. The differential nature of the LTC6410-6 allows for ease of use in differential signal chains, and may reduce the need for transformers.

SAW Filter Application

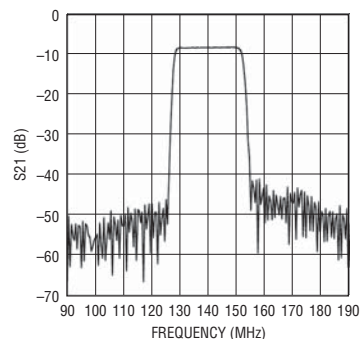

64106 TA08

PACKAGE DESCRIPTION

UD Package
16-Lead Plastic QFN (3mm × 3mm)
 (Reference LTC DWG # 05-08-1691)

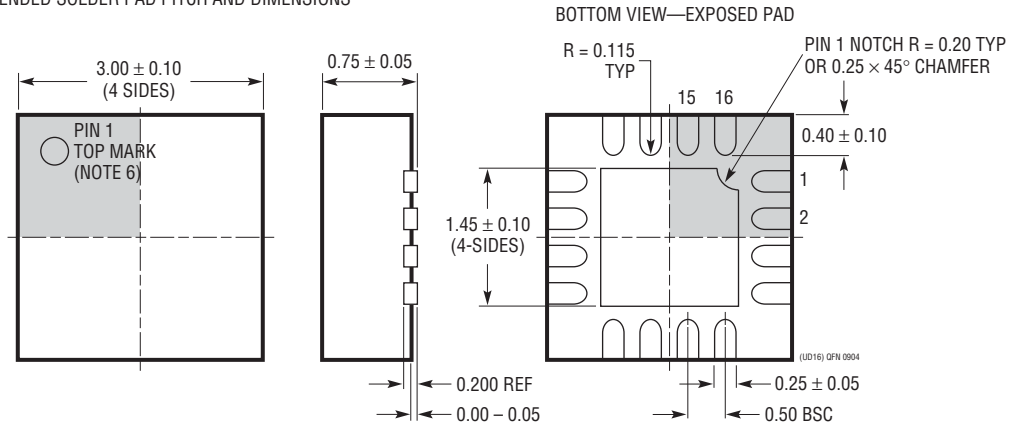
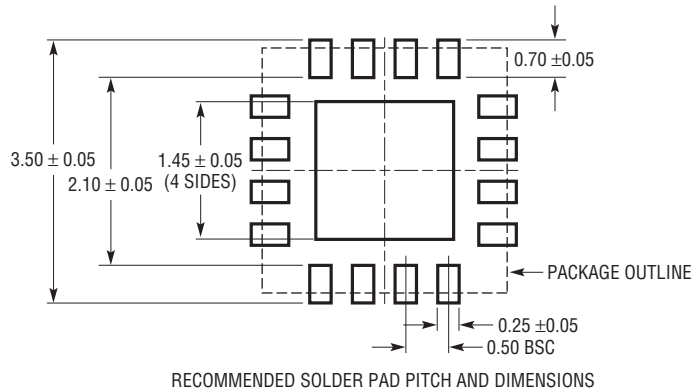

1. DRAWING CONFORMS TO JEDEC PACKAGE OUTLINE MO-220 VARIATION (WEED-2)
2. DRAWING NOT TO SCALE
3. ALL DIMENSIONS ARE IN MILLIMETERS
4. DIMENSIONS OF EXPOSED PAD ON BOTTOM OF PACKAGE DO NOT INCLUDE MOLD FLASH. MOLD FLASH, IF PRESENT, SHALL NOT EXCEED 0.15mm ON ANY SIDE
5. EXPOSED PAD SHALL BE SOLDER PLATED
6. SHADED AREA IS ONLY A REFERENCE FOR PIN 1 LOCATION ON THE TOP AND BOTTOM OF PACKAGE