

NETWORK FEATURES

- Complete **Radio Transceiver, Embedded Processor, and Networking Software** for Forming a Self-Healing Mesh Network
- Compliant to WirelessHART (IEC62591) Standard
- SmartMesh® Networks Incorporate:
 - Time synchronized Network-Wide Scheduling
 - Per Transmission Frequency Hopping
 - Redundant Spatially Diverse Topologies
 - Network-Wide Reliability and Power Optimization
 - NIST Certified Security
- SmartMesh Networks Deliver:
 - >99.999% Network Reliability Achieved in the Most Challenging Dynamic RF Environments Often Found in Industrial Applications
 - Sub 50µA Routing Nodes

LTP5901/2-WHM FEATURES

- Industry-leading low power radio technology with:
 - 4.5mA to receive a packet
 - 5.4mA to transmit at 0dBm
 - 9.7mA to transmit at 8dBm
- RF modular certifications include USA, Canada, EU, Japan, Taiwan, Korea, India, Australia and New Zealand
- PCB assembly with chip antenna (LTP5901-WHM) or with MMCX antenna connector (LTP5902-WHM). QFN version (LTC®5800-WHM) available

DESCRIPTION

SmartMesh WirelessHART wireless sensor networks are self managing, low power networks built from wireless nodes called motes. The **LTP™5901-WHM/LTP5902-WHM** is the WirelessHART mote product in the Eterna®* family of IEEE 802.15.4 printed circuit board assembly solutions, featuring a highly-integrated, low power radio design by Dust Networks® as well as an ARM Cortex-M3 32-bit microprocessor running Dust’s embedded SmartMesh WirelessHART networking software. Both the LTP5901-WHM (with chip antenna), at 24mm × 42mm, and the LTP5902-WHM (with MMCX connector), at 24mm×37mm, are designed for surface mount assembly.

With Dust’s time-synchronized WirelessHART networks, all motes in the network may route, source or terminate data, while providing many years of battery powered operation. The SmartMesh WirelessHART software provided with the LTP5901/2-WHM is fully tested and validated, and is readily configured via a software Application Programming Interface (API).

SmartMesh WirelessHART motes deliver a highly flexible network with proven reliability and low power performance in an easy-to-integrate platform.

DT, LT, LTC, LTM, Eterna, SmartMesh, Linear Technology, the Linear logo, Dust and Dust Networks are registered trademarks and LTP and the Dust Networks logo are trademarks of Linear Technology Corporation. All other trademarks are the property of their respective owners. Protected by U.S. Patents, including 7375594, 7420980, 7529217, 7791419, 7881239, 7898322, 8222965.

* Eterna is Dust Networks’ low power radio SoC architecture.

TYPICAL APPLICATION

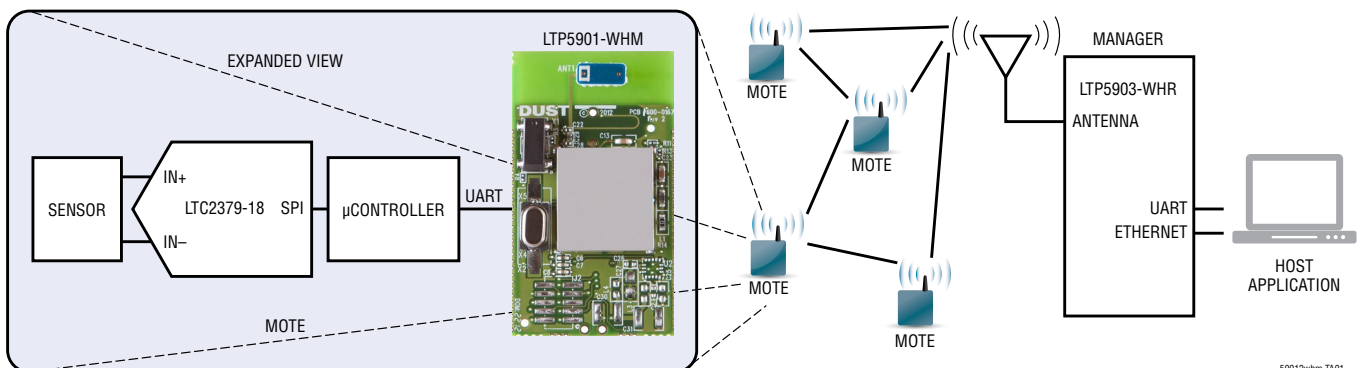

59012whm TA01
59012whmfa

TABLE OF CONTENTS

Network Features	1	Operation.....	21
LTP5901/2-WHM FEATURES	1	Power Supply.....	21
Typical Application	1	Supply Monitoring and Reset	21
Description.....	1	Precision Timing.....	21
Smartmesh Network Overview.....	3	Application Time Synchronization	23
Absolute Maximum Ratings	4	Time References	23
Pin Configuration	4	Radio	23
Order Information	5	UARTs.....	23
Recommended Operating Conditions.....	5	Autonomous MAC.....	24
DC Characteristics	5	Security	25
Radio Specifications	6	Temperature Sensor	25
Radio Receiver Characteristics.....	6	Radio Inhibit	25
Radio Transmitter Characteristics.....	7	Software Installation.....	25
Digital I/O Characteristics	7	Flash Data Retention.....	25
Temperature Sensor Characteristics.....	8	State Diagram.....	26
Analog Input Chain Characteristics	8	Applications Information	28
System Characteristics	8	Regulatory and Standards Compliance.....	28
UART AC Characteristics.....	9	Soldering Information.....	28
TIMEn AC Characteristics.....	10	Related Documentation	28
Radio Inhibit AC Characteristics.....	10	Package Description	29
Flash AC Characteristics.....	11	Revision History	31
Flash SPI Slave AC Characteristics	11	Typical Application	32
Typical Performance Characteristics	13	Related Parts	32
Pin Functions	17		

SMARTMESH NETWORK OVERVIEW

A SmartMesh network consists of a self-forming multi-hop, mesh of nodes, known as motes, which collect and relay data, and a Network Manager that monitors and manages network performance and security, and exchanges data with a host application.

SmartMesh networks communicate using a Time Slotted Channel Hopping (TSCH) link layer, pioneered by Dust Networks. In a TSCH network, all motes in the network are synchronized to within less than a millisecond. Time in the network is organized into timeslots, which enables collision-free packet exchange and per-transmission channel-hopping. In a SmartMesh network, every device has one or more parents (e.g. mote 3 has motes 1 and 2 as parents) that provide redundant paths to overcome communications interruption due to interference, physical obstruction or multi-path fading. If a packet transmission fails on one path, the next retransmission may try on a different path and different RF channel.

A network begins to form when the network manager instructs its on-board Access Point (AP) radio to begin sending advertisements - packets that contain information that enables a device to synchronize to the network and request to join. This message exchange is part of the security handshake that establishes encrypted communications between the manager or application, and mote. Once motes have joined the network, they maintain synchronization through time corrections when a packet is acknowledged.

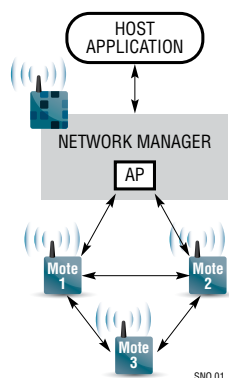

An ongoing discovery process ensures that the network continually discovers new paths as the RF conditions change. In addition, each mote in the network tracks performance statistics (e.g. quality of used paths, and lists of potential paths) and periodically sends that information to the network manager in packets called health reports.

The Network Manager uses health reports to continually optimize the network to maintain >99.999% data reliability even in the most challenging RF environments.

The use of TSCH allows SmartMesh devices to sleep in-between scheduled communications and draw very little power in this state. Motes are only active in timeslots where they are scheduled to transmit or receive, typically resulting in a duty cycle of < 1%. The optimization software in the Network Manager coordinates this schedule automatically. When combined with the Eterna low power radio, every mote in a SmartMesh network – even busy routing ones – can run on batteries for years. By default, all motes in a network are capable of routing traffic from other motes, which simplifies installation by avoiding the complexity of having distinct routers vs. non-routing end nodes. Motes may be configured as non-routing to further reduce that particular mote's power consumption and to support a wide variety of network topologies.

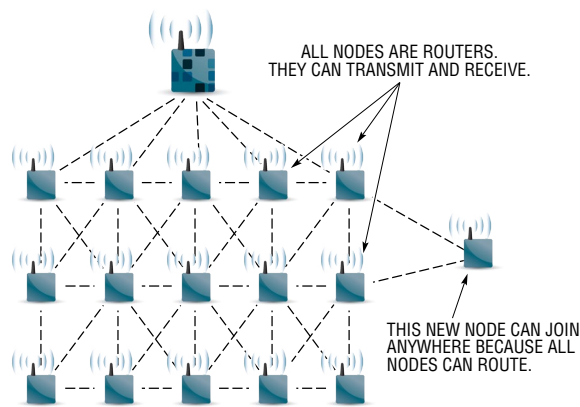

At the heart of SmartMesh motes and network managers is the Eterna IEEE 802.15.4e System-on-Chip (SoC), featuring Dust Networks' highly-integrated, low power radio design, plus an ARM Cortex-M3 32-bit microprocessor running SmartMesh networking software. The SmartMesh networking software comes fully compiled yet is configurable via a rich set of Application Programming Interfaces (APIs) which allows a host application to interact with the network, e.g. to transfer information to a device, to configure data publishing rates on one or more motes, or to monitor network state or performance metrics. Data publishing can be uniform or different for each device, with motes being able to publish infrequently or faster than once per second as needed.

59012whmfa

LTP5901-WHM/LTP5902-WHM

ABSOLUTE MAXIMUM RATINGS

(Note 1, Note 2)

Supply Voltage on VSUPPLY	4.20V
Input Voltage on AI_0/1/2/3 Inputs	1.98V
Voltage on any Digital I/O Pin	-0.3V to VSUPPLY +0.3V
Input RF Level	10dBm
Storage Temperature Range (Note 3).....	-55°C to 105°C

Operating Temperature Range	
LTP5901/LPT5902I.....	-40°C to 85°C

CAUTION: This part is sensitive to electrostatic discharge (ESD). It is very important that proper ESD precautions be observed when handling the LTP5901/LTP5902-WHM.

PIN CONFIGURATION

Pin functions shown in *italics* are currently not supported in software.



59012whmfa

ORDER INFORMATION

LEAD FREE FINISH†	PART MARKING*	PACKAGE DESCRIPTION	TEMPERATURE RANGE
LTP5901IPC-WHMA#PBF	LTP5901IPC-WHMA#PBF	66-Lead (42mm × 24mm × 5.5mm) PCB with Chip Antenna	-40°C to 85°C
LTP5902IPC-WHMA#PBF	LTP5902IPC-WHMA#PBF	66-Lead (37.5mm × 24mm × 5.5mm) PCB with MMCX Connector	-40°C to 85°C

†This product ships with the flash erased at the time of order. OEMs will need to program devices during development and manufacturing.

For legacy part numbers and ordering information go to: <http://www.linear.com/LTP5901-WHM#orderinfo> or <http://www.linear.com/LTP5902-WHM#orderinfo>

*The temperature grade is identified by a label on the shipping container.

For more information on lead free part marking, go to: <http://www.linear.com/leadfree/>

RECOMMENDED OPERATING CONDITIONS

The ● denotes the specifications which apply over the full operating temperature range, otherwise specifications are at $T_A = 25^\circ\text{C}$ and $V_{\text{SUPPLY}} = 3.6\text{V}$ unless otherwise noted.

SYMBOL	PARAMETER	CONDITIONS	MIN	TYP	MAX	UNITS
VSUPPLY	Supply Voltage	Including Noise and Load Regulation	● 2.1		3.76	V
	Supply Noise	50Hz to 2MHz	●		250	mV
	Operating Relative Humidity	Non-Condensing	● 10		90	%RH
	Temperature Ramp Rate	While Operating in Network	● -8		8	°C/Min

DC CHARACTERISTICS

The ● denotes the specifications which apply over the full operating temperature range, otherwise specifications are at $T_A = 25^\circ\text{C}$ and $V_{\text{SUPPLY}} = 3.6\text{V}$ unless otherwise noted.

OPERATION/STATE	CONDITIONS	MIN	TYP	MAX	UNITS
Power-on Reset	During Power-on Reset, Maximum 750 μs + VSUPPLY Rise Time from 1V to 1.9V		12		mA
Doze	RAM on, ARM Cortex-M3, Flash, Radio, and Peripherals Off, All Data and State Retained, 32.768kHz Reference Active		1.2		μA
Deep Sleep	RAM on, ARM Cortex-M3, Flash, Radio, and Peripherals Off, All Data and State Retained, 32.768kHz Reference Inactive		0.8		μA
In-circuit Programming	RESETn and FLASH_P_ENn Asserted, IPCS_SCK at 8MHz		20		mA
Peak Operating Current	System Operating at 14.7MHz, Radio Transmitting, During Flash Write. Maximum duration 4.33 ms.		30		mA
			26		mA
Active	ARM Cortex M3, RAM and Flash Operating, Radio and All Other Peripherals Off. Clock Frequency of CPU and Peripherals Set to 7.3728MHz, V _{CORE} = 1.2V		1.3		mA
Flash Write	Single Bank Flash Write		3.7		mA
Flash Erase	Single Bank Page or Mass Erase		2.5		mA
Radio Tx	Current With Autonomous MAC Managing Radio Operation, CPU Inactive. Clock Frequency of CPU and Peripherals Set to 7.3728MHz.		5.4		mA
			9.7		mA
Radio Rx	Current With Autonomous MAC Managing Radio Operation, CPU Inactive. Clock Frequency of CPU and Peripherals Set to 7.3728MHz.		4.5		mA

LTP5901-WHM/LTP5902-WHM

RADIO SPECIFICATIONS

The ● denotes the specifications which apply over the full operating temperature range, otherwise specifications are at $T_A = 25^\circ\text{C}$ and $V_{\text{SUPPLY}} = 3.6\text{V}$ unless otherwise noted.

PARAMETER	CONDITIONS	MIN	TYP	MAX	UNITS
Frequency Band	●	2.4000		2.4835	GHz
Number of Channels	●		15		
Channel Separation	●		5		MHz
Channel Center Frequency	Where $k = 11$ to 25 , as Defined by IEEE.802.15.4	●	$2405 + 5 \cdot (k-11)$		MHz
Raw Data Rate	●		250		kbps
Antenna Pin ESD Protection	HBM Per JEDEC JESD22-A114F		± 6000		V
Range (Note 4)	25°C, 50% RH, +2dBi Omni-Directional Antenna, Antenna 2m Above Ground		100		m
Indoor			300		m
Outdoor			1200		m
Free Space					m

RADIO RECEIVER CHARACTERISTICS

The ● denotes the specifications which apply over the full operating temperature range, otherwise specifications are at $T_A = 25^\circ\text{C}$ and $V_{\text{SUPPLY}} = 3.6\text{V}$ unless otherwise noted.

PARAMETER	CONDITIONS	MIN	TYP	MAX	UNITS
Receiver Sensitivity	Packet Error Rate (PER) = 1% (Note 5)		-93		dBm
Receiver Sensitivity	PER = 50%		-95		dBm
Saturation	Maximum Input Level the Receiver Will Properly Receive Packets		0		dBm
Adjacent Channel Rejection (High Side)	Desired Signal at -82dBm, Adjacent Modulated Channel 5MHz Above the Desired Signal, PER = 1% (Note 5)		22		dBc
Adjacent Channel Rejection (Low Side)	Desired Signal at -82dBm, Adjacent Modulated Channel 5MHz Below the Desired Signal, PER = 1% (Note 5)		19		dBc
Alternate Channel Rejection (High Side)	Desired Signal at -82dBm, Alternate Modulated Channel 10MHz Above the Desired Signal, PER = 1% (Note 5)		40		dBc
Alternate Channel Rejection (Low Side)	Desired Signal at -82dBm, Alternate Modulated Channel 10MHz Below the Desired Signal, PER = 1% (Note 5)		36		dBc
Second Alternate Channel Rejection	Desired Signal at -82dBm, Second Alternate Modulated Channel Either 15MHz Above or Below, PER = 1% (Note 5)		42		dBc
Co-Channel Rejection	Desired Signal at -82dBm, Undesired Signal is an 802.15.4 Modulated Signal at the Same Frequency, PER = 1%		-6		dBc
LO Feed Through			-55		dBm
Frequency Error Tolerance (Note 6)			± 50		ppm
Symbol Error Tolerance			± 50		ppm
Received Signal Strength Indicator (RSSI) Input Range			-90 to -10		dBm
RSSI Accuracy			± 6		dB
RSSI Resolution			1		dB

59012whmfa

RADIO TRANSMITTER CHARACTERISTICS

The ● denotes the specifications which apply over the full operating temperature range, otherwise specifications are at $T_A = 25^\circ\text{C}$ and $V_{\text{SUPPLY}} = 3.6\text{V}$ unless otherwise noted.

PARAMETER	CONDITIONS	MIN	TYP	MAX	UNITS
Output Power High Calibrated Setting Low Calibrated Setting	Delivered to a 50Ω load		8		dBm
			0		dBm
Spurious Emissions 30 MHz to 1000 MHz 1 GHz to 12.75 GHz 2.4 GHz ISM Upper Band Edge (Peak) 2.4 GHz ISM Upper Band Edge (Average) 2.4 GHz ISM Lower Band Edge	Conducted Measurement with a 50Ω Single-ended Load, +8dBm Output Power. All Measurements Made with Max Hold. $R_{\text{BW}} = 120\text{kHz}, V_{\text{BW}} = 100\text{Hz}$ $R_{\text{BW}} = 1\text{MHz}, V_{\text{BW}} = 3\text{MHz}$ $R_{\text{BW}} = 1\text{MHz}, V_{\text{BW}} = 3\text{MHz}$ $R_{\text{BW}} = 1\text{MHz}, V_{\text{BW}} = 10\text{Hz}$ $R_{\text{BW}} = 100\text{kHz}, V_{\text{BW}} = 100\text{kHz}$		<-70		dBm
			-45		dBm
			-37		dBm
			-49		dBm
			-45		dBc
Harmonic Emissions 2nd Harmonic 3rd Harmonic	Conducted Measurement Delivered to a 50Ω Load, Resolution Bandwidth = 1MHz, Video Bandwidth = 1MHz.		-50		dBm
			-45		dBm

DIGITAL I/O CHARACTERISTICS

The ● denotes the specifications which apply over the full operating temperature range, otherwise specifications are at $T_A = 25^\circ\text{C}$ and $V_{\text{SUPPLY}} = 3.6\text{V}$ unless otherwise noted.

SYMBOL	PARAMETER	CONDITIONS	MIN	TYP	MAX	UNITS
V_{IL}	Low Level Input Voltage	(Note 7)	● -0.3		0.6	V
V_{IH}	High Level Input Voltage	(Note 8)	● $V_{\text{SUPPLY}} - 0.3$		$V_{\text{SUPPLY}} + 0.3$	V
V_{OL}	Low Level Output Voltage	Type 1, $I_{\text{OL(MAX)}} = 1.2\text{mA}$	●		0.4	V
V_{OH}	High Level Output Voltage	Type 1, $I_{\text{OH(MAX)}} = -0.8\text{mA}$	● $V_{\text{SUPPLY}} - 0.3$		$V_{\text{SUPPLY}} + 0.3$	V
V_{OL}	Low Level Output Voltage	Type 2, Low Drive, $I_{\text{OL(MAX)}} = 2.2\text{mA}$	●		0.4	V
V_{OH}	High Level Output Voltage	Type 2, Low Drive, $I_{\text{OH(MAX)}} = -1.6\text{mA}$	● $V_{\text{SUPPLY}} - 0.3$		$V_{\text{SUPPLY}} + 0.3$	V
V_{OL}	Low Level Output Voltage	Type 2, High Drive, $I_{\text{OL(MAX)}} = 4.5\text{mA}$	●		0.4	V
V_{OH}	High Level Output Voltage	Type 2, High Drive, $I_{\text{OH(MAX)}} = -3.2\text{mA}$	● $V_{\text{SUPPLY}} - 0.3$		$V_{\text{SUPPLY}} + 0.3$	V
	Input Leakage Current	Input Driven to V_{SUPPLY} or GND		50		nA
	Pull-Up / Pull-Down Resistance			50		kΩ

LTP5901-WHM/LTP5902-WHM

TEMPERATURE SENSOR CHARACTERISTICS

The ● denotes the specifications which apply over the full operating temperature range, otherwise specifications are at $T_A = 25^\circ\text{C}$ and $V_{\text{SUPPLY}} = 3.6\text{V}$ unless otherwise noted.

PARAMETER	CONDITIONS	MIN	TYP	MAX	UNITS
Offset	Temperature Offset Error at 25°C		± 0.25		$^\circ\text{C}$
Slope Error			± 0.033		$^\circ\text{C}/^\circ\text{C}$

ANALOG INPUT CHAIN CHARACTERISTICS

The ● denotes the specifications which apply over the full operating temperature range, otherwise specifications are at $T_A = 25^\circ\text{C}$ and $V_{\text{SUPPLY}} = 3.6\text{V}$ unless otherwise noted.

SYMBOL	PARAMETER	CONDITIONS	MIN	TYP	MAX	UNITS
	Variable Gain Amplifier Gain Gain Error		1		8 2	%
DNL	Offset-Digital to Analog Converter (DAC) Full-scale Resolution Differential Non-Linearity			1.80 4	2.7	V Bits mV
DNL INL	Analog to Digital Converter (ADC) Full-scale, Signal Resolution Offset Differential Non-Linearity Integral Non-Linearity Settling Time Conversion Time Current Consumption	Mid-Scale 10k Ω Source Impedance		1.80 1.8 1.4	12 1 1 10 20	V mV LSB LSB LSB μs μs μA
	Analog Inputs (Note 9) Load Series Input Resistance			20 1		pF k Ω

SYSTEM CHARACTERISTICS

The ● denotes the specifications which apply over the full operating temperature range, otherwise specifications are at $T_A = 25^\circ\text{C}$ and $V_{\text{SUPPLY}} = 3.6\text{V}$ unless otherwise noted.

SYMBOL	PARAMETER	CONDITIONS	MIN	TYP	MAX	UNITS
	Doze to Active State Transition			5		μs
	Doze to Radio Tx or Rx			1.2		ms
Q_{CCA}	Charge to Sample RF Channel RSSI	Charge Consumed Starting from Doze State and Completing an RSSI Measurement		4		μC
Q_{MAX}	Largest Atomic Charge Operation	Flash Erase, 21 ms Max duration	●		200	μC
	RESETn Pulse Width		●	125		μs
	Total Capacitance	Note 13	●		6	μF
	Total Inductance	Note 13	●		3	μH

UART AC CHARACTERISTICS

The ● denotes the specifications which apply over the full operating temperature range, otherwise specifications are at $T_A = 25^\circ\text{C}$ and $V_{\text{SUPPLY}} = 3.6\text{V}$ unless otherwise noted. (Note 13)

SYMBOL	PARAMETER	CONDITIONS		MIN	TYP	MAX	UNITS
	Permitted Rx Baud Rate Error	Both Application Programming Interface (API) and Command Line Interface (CLI) UARTs	●	-2		2	%
	Generated Tx Baud Rate Error	Both API and CLI UARTs	●	-1		1	%
$t_{\text{RX_RTS to RX_CTS}}$	Assertion of UART_RX_RTSn to Assertion of UART_RX_CTSn, or Negation of UART_RX_RTSn to Negation of UART_RX_CTSn		●	0		2	ms
$t_{\text{CTS_R to RX}}$	Assertion of UART_RX_CTSn to Start of Byte		●	0		20	ms
$t_{\text{EOP to RX_RTS}}$	End of Packet (End of the Last Stop Bit) to Negation of UART_RX_RTSn		●	0		22	ms
$t_{\text{BEG_TX_RTS to TX_CTS}}$	Assertion of UART_TX_RTSn to Assertion of UART_TX_CTSn			0		22	ms
$t_{\text{END_TX_CTS to TX_RTS}}$	Negation of UART_TX_CTSn to Negation of UART_TX_RTSn			2			Bit Period
$t_{\text{TX_CTS to TX}}$	Assertion of UART_TX_CTSn to Start of Byte			0		2	Bit Period
$t_{\text{EOP to TX_RTS}}$	End of Packet (End of the Last Stop Bit) to Negation of UART_TX_RTSn		●	0		1	Bit Period
$t_{\text{RX_INTERBYTE}}$	Receive Inter-Byte Delay		●			100	ms
$t_{\text{RX_INTERPACKET}}$	Receive Inter-Packet Delay		●	20			ms
$t_{\text{TX_INTERPACKET}}$	Transmit Inter-Packet Delay		●	1			Bit Period
$t_{\text{TX to TX_CTS}}$	Start of Byte to Negation of UART_TX_CTSn		●	0			ns

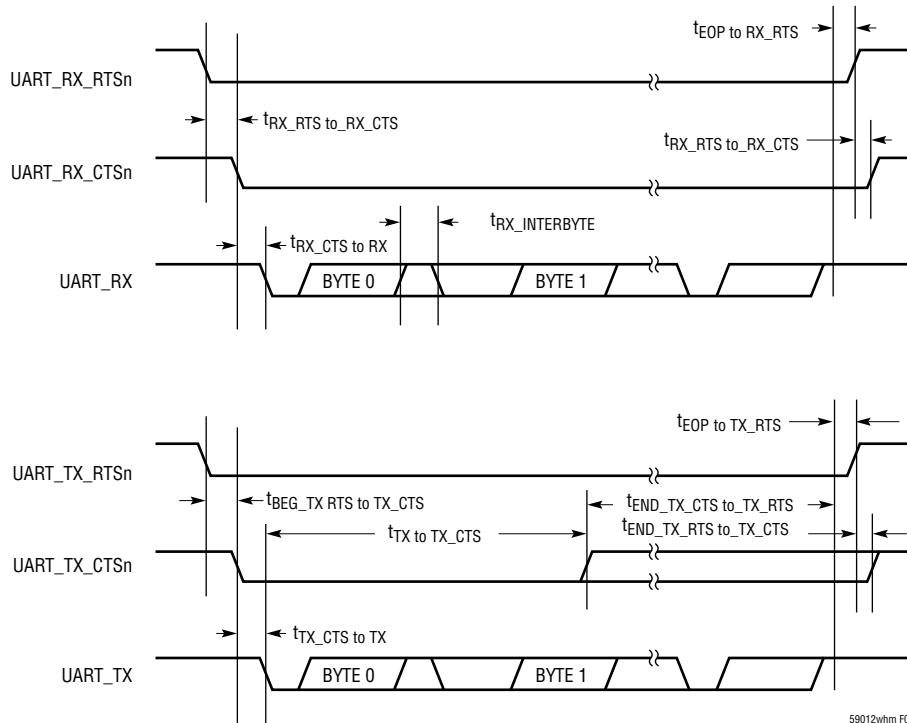

Figure 1. API UART Timing

59012whm F01

TIMEn AC CHARACTERISTICS

The ● denotes the specifications which apply over the full operating temperature range, otherwise specifications are at $T_A = 25^\circ\text{C}$ and $V_{\text{SUPPLY}} = 3.6\text{V}$ unless otherwise noted. (Note 13)

SYMBOL	PARAMETER	CONDITIONS	MIN	TYP	MAX	UNITS
t_{STROBE}	TIMEn Signal Strobe Width		●	125		μs
t_{RESPONSE}	Delay from Rising Edge of TIMEn to the Start of Time Packet on API UART		●	0	100	ms
$t_{\text{TIME_HOLD}}$	Delay from End of Time Packet on API UART to Falling Edge of Subsequent TIMEn		●	0		ns
	Timestamp Resolution (Note 10)		●	1		μs
	Network-Wide Time Accuracy (Note 11)		●	± 5		μs

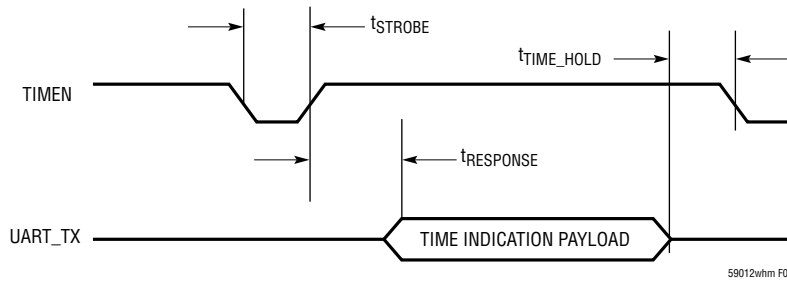

Figure 2. Timestamp Timing

RADIO INHIBIT AC CHARACTERISTICS

The ● denotes the specifications which apply over the full operating temperature range, otherwise specifications are at $T_A = 25^\circ\text{C}$ and $V_{\text{SUPPLY}} = 3.6\text{V}$ unless otherwise noted. (Note 13)

SYMBOL	PARAMETER	CONDITIONS	MIN	TYP	MAX	UNITS
$t_{\text{RADIO_OFF}}$	Delay from Rising Edge of RADIO_INHIBIT to Radio Disabled		●		20	ms
$t_{\text{RADIO_INHIBIT_STROBE}}$	Maximum RADIO_INHIBIT Strobe Width		●		2	s

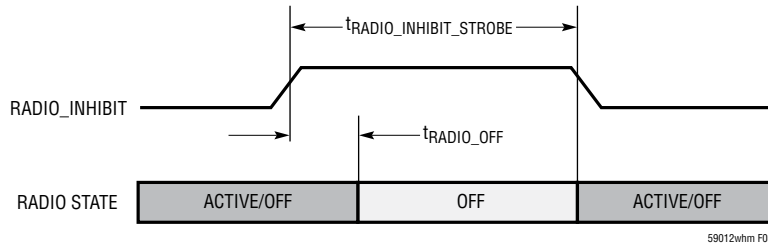

Figure 3. RADIO_INHIBIT Timing

FLASH AC CHARACTERISTICS

The ● denotes the specifications which apply over the full operating temperature range, otherwise specifications are at $T_A = 25^\circ\text{C}$ and $V_{\text{SUPPLY}} = 3.6\text{V}$ unless otherwise noted. (Note 13)

SYMBOL	PARAMETER	CONDITIONS	MIN	TYP	MAX	UNITS
t_{WRITE}	Time to Write a 32-bit Word (Note 12)	●			21	μs
$t_{\text{PAGE_ERASE}}$	Time to Erase a 2KByte Page (Note 12)	●			21	ms
$t_{\text{MASS_ERASE}}$	Time to Erase 256KByte Flash Bank (Note 12)	●			21	ms
	Data Retention	25°C 85°C 105°C	100 20 8			Years Years Years

FLASH SPI SLAVE AC CHARACTERISTICS

The ● denotes the specifications which apply over the full operating temperature range, otherwise specifications are at $T_A = 25^\circ\text{C}$ and $V_{\text{SUPPLY}} = 3.6\text{V}$ unless otherwise noted. (Note 13)

SYMBOL	PARAMETER	CONDITIONS	MIN	TYP	MAX	UNITS
$t_{\text{FP_EN_to_RESET}}$	Setup from Assertion of FLASH_P_ENn to Assertion of RESETn	●	0			ns
$t_{\text{FP_ENTER}}$	Delay from the Assertion RESETn to the First Falling Edge of IPCS_SSn	●	125			μs
$t_{\text{FP_EXIT}}$	Delay from the Completion of the Last Flash SPI Slave Transaction to the Negation of RESETn and FLASH_P_ENn (Note 13)	●	10			μs
t_{SSS}	IPCS_SSn Setup to the Leading Edge of IPCS_SCK	●	15			ns
t_{SSH}	IPCS_SSn Hold from Trailing Edge of IPCS_SCK	●	15			ns
t_{CK}	IPCS_SCK Period	●	300			ns
t_{DIS}	IPCS_MOSI Data Setup	●	15			ns
t_{DIH}	IPCS_MOSI Data Hold	●	5			ns
t_{DOV}	IPCS_MISO Data Valid	●	-5		30	ns
t_{OFF}	IPCS_MISO Data Tri-state	●	0		30	ns

FLASH SPI SLAVE AC CHARACTERISTICS

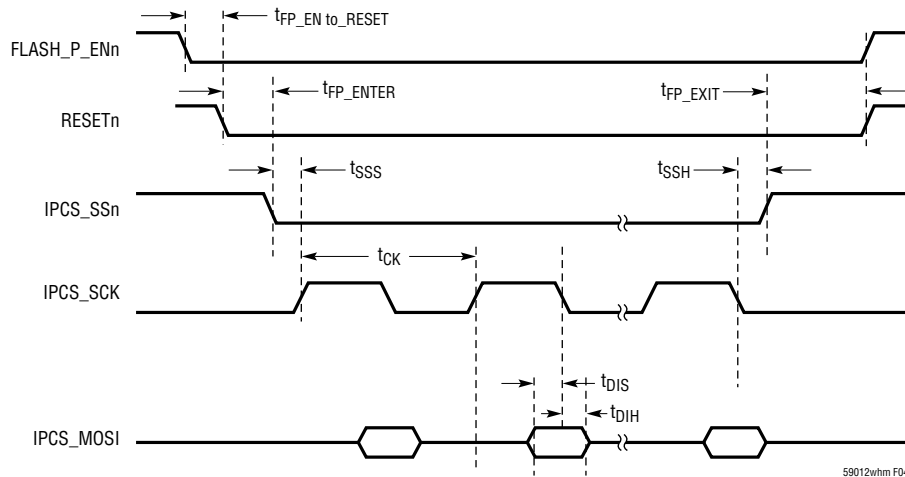

Figure 4. Flash Programming Interface Timing

Note 1: Stresses beyond those listed under Absolute Maximum Ratings may cause permanent damage to the device. Exposure to any Absolute Maximum Rating condition for extended periods may affect device reliability and lifetime.

Note 2: ESD (electrostatic discharge) sensitive device. ESD protection devices are used extensively internal to Eterna. However, high electrostatic discharge can damage or degrade the device. Use proper ESD handling precautions.

Note 3: Extended storage at high temperature is discouraged, as this negatively affects the data retention of Eterna's calibration data. See the FLASH Data Retention section for details.

Note 4: Actual RF range is subject to a number of installation-specific variables including, but not restricted to ambient temperature, relative humidity, presence of active interference sources, line-of-sight obstacles, and near-presence of objects (for example, trees, walls, signage, and so on) that may induce multipath fading. As a result, range varies.

Note 5: As Specified by IEEE Std. 802.15.4-2006: Wireless Medium Access Control (MAC) and Physical Layer (PHY) Specifications for Low-Rate Wireless Personal Area Networks (LR-WPANs) <http://standards.ieee.org/findstds/standard/802.15.4-2011.html>.

Note 6: IEEE Std. 802.15.4-2006 requires transmitters to maintain a frequency tolerance of better than ± 40 ppm.

Note 7: Per pin I/O types are provided in the Pin Functions section.

Note 8: VIH maximum voltage input must respect the VSUPPLY maximum voltage specification.

Note 9: The analog inputs to the ADC can be modeled as a series resistor to a capacitor. At a minimum the entire circuit, including the source impedance for the signal driving the analog input should be designed to settle to within $\frac{1}{4}$ LSB within the sampling window to match the performance of the ADC.

Note 10: See the [SmartMesh WirelessHART Mote API Guide](#) for the time indication notification definition.

Note 11: Network time accuracy is a statistical measure and varies over the temperature range, reporting rate and the location of the device relative to the manager in the network. See the Typical Performance Characteristics section for a more detailed description.

Note 12: Code execution from flash banks being written or erased is suspended until completion of the flash operation.

Note 13: Guaranteed by design. Not production tested.

TYPICAL PERFORMANCE CHARACTERISTICS

Network motes typically route through at least two parents the traffic destined for the manager. The supply current graphs shown below include a parameter called traffic-weighted descendants. In these graphs the term traffic-weighted descendants refers to an amount of activity equivalent to the number of descendants if all of the network traffic was directed to the mote in question. Generally the number of descendants of a parent is more, typically 2x or more, than the number of traffic-weighted descendants. For example, with reference to Figure 6 mote P1 has 0.75 traffic-weighted descendants. To obtain this value notice that mote D1 routes half its packets through mote P1 adding 0.5 to the traffic-weighted descendant value; the other half of D1's traffic is routed through its other parent, P2. Mote D2 routes half its packets through mote D1 (the other half going through parent P3), which we know routes half its packets to mote P1, adding another 0.25 to the traffic-weighted descendant value for a total traffic-weighted descendant value of 0.75.

As described in the Application Time Synchronization section, Eterna provides two mechanisms for applications to maintain a time base across a network. The synchronization performance plots that follow were generated using the more precise TIMEn input. Publishing rate is the rate a mote application sends upstream data. Synchronization improves as the publishing rate increases. Baseline synchronization performance is provided for a network operating with a publishing rate of zero. Actual performance for applications in network will improve

as publishing rates increase. All synchronization testing was performed with the 1-hop mote inside a temperature chamber. Timing errors due to temperature changes and temperature differences both between the manager and this mote and between this mote and its descendants therefore propagated down through the network. The synchronization of the 3-hop and 5-hop motes to the manager was then affected by the temperature ramps even though they were at room temperature. For 2°C/minute testing the temperature chamber was cycled between -40°C and 85°C at this rate for 24 hours. For 8°C/minute testing, the temperature chamber was rapidly cycled between 85°C and 45°C for 8 hours, followed by rapid cycling between -5°C and 45°C for 8 hours, and lastly, rapid cycling between -40°C and 15°C for 8 hours.

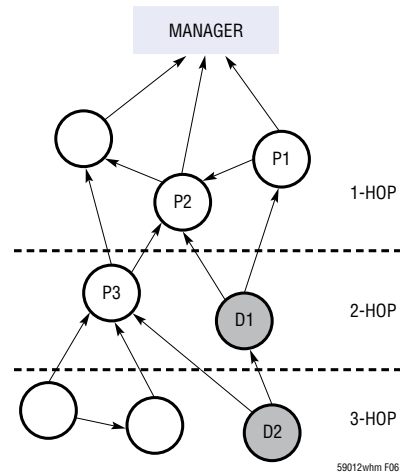

Figure 6. Example Network Graph

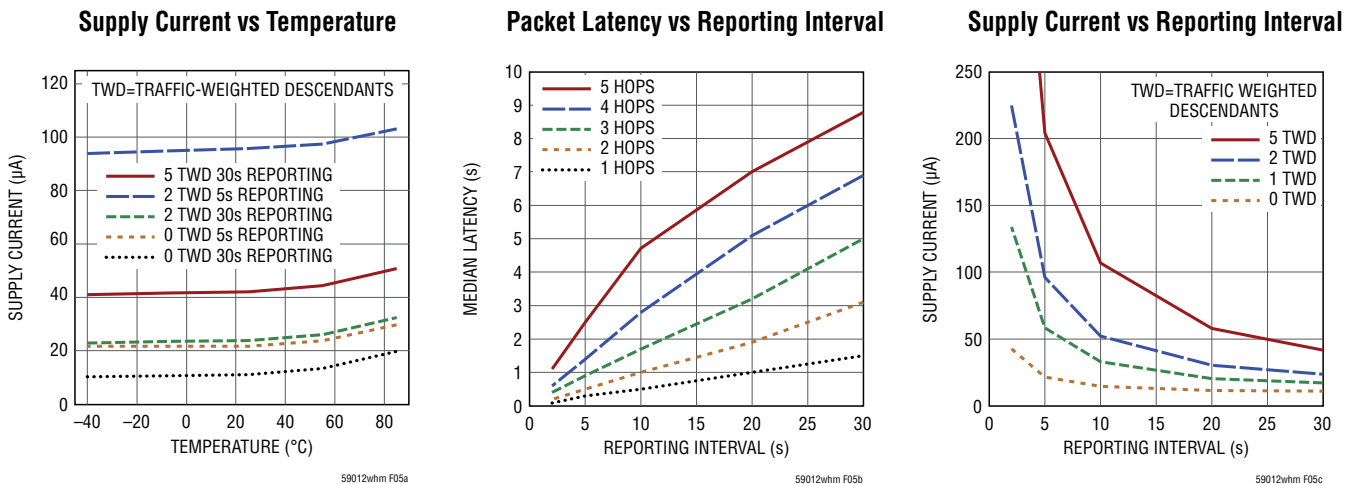
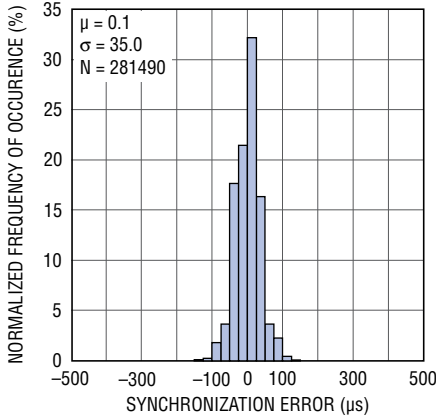

Figure 5

TYPICAL PERFORMANCE CHARACTERISTICS

**TIMEn Synchronization Error
0 Packet/s Publishing Rate,
1 Hop, Room Temperature**



59012whm G01

**TIMEn Synchronization Error
0 Packet/s Publishing Rate,
3 Hops, Room Temperature**

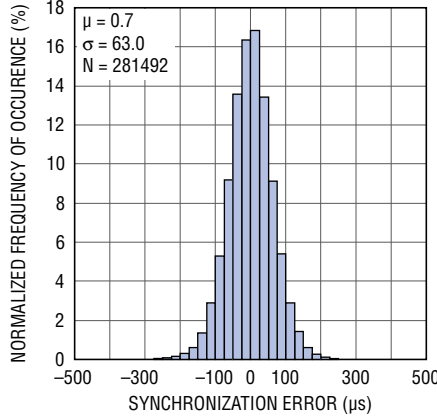

59012whm G02

**TIMEn Synchronization Error
0 Packet/s Publishing Rate,
5 Hops, Room Temperature**

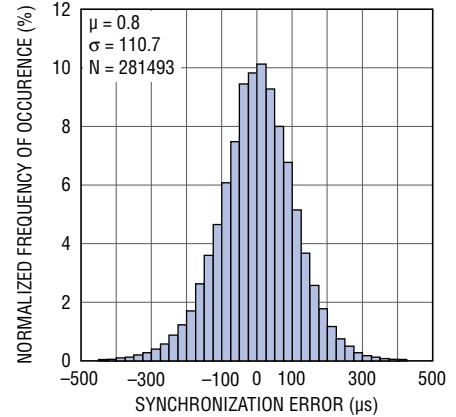

59012whm G03

**TIMEn Synchronization Error
0 Packet/s Publishing Rate,
1 Hop, 2°C/Min**

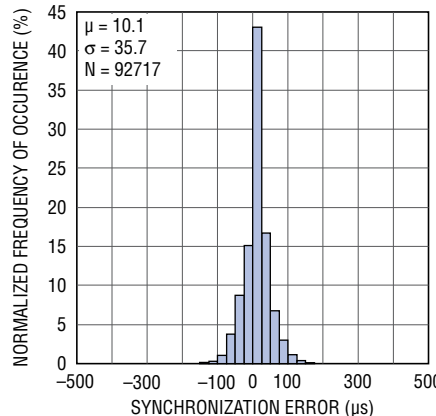

59012whm G04

**TIMEn Synchronization Error
0 Packet/s Publishing Rate,
3 Hops, 2°C/Min**

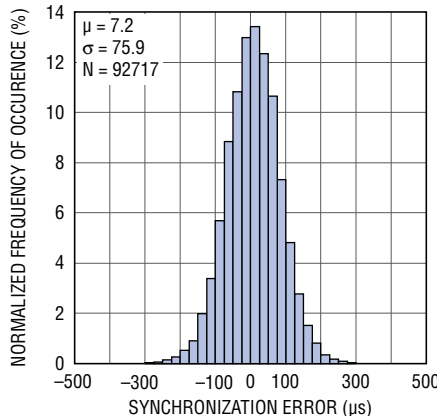

59012whm G05

**TIMEn Synchronization Error
0 Packet/s Publishing Rate,
5 Hops, 2°C/Min**

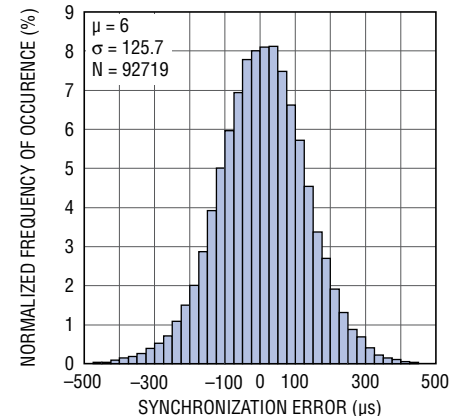

59012whm G06

**TIMEn Synchronization Error
0 Packet/s Publishing Rate,
1 Hop, 8°C/Min**

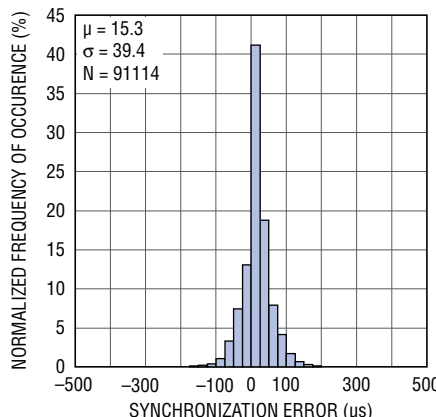

59012whm G07

**TIMEn Synchronization Error
0 Packet/s Publishing Rate,
3 Hops, 8°C/Min**

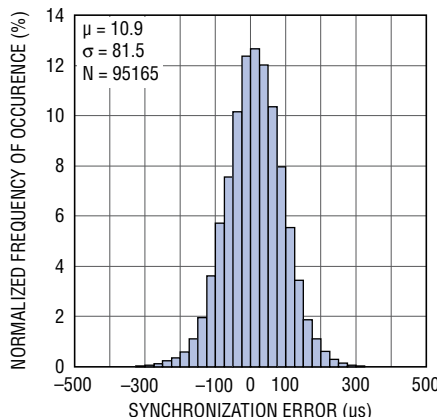

59012whm G08

**TIMEn Synchronization Error
0 Packet/s Publishing Rate,
5 Hops, 8°C/Min**

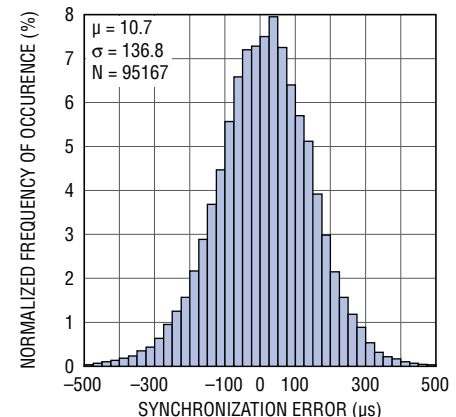

59012whm G09

TYPICAL PERFORMANCE CHARACTERISTICS

As described in the SmartMesh Network Overview section, devices in network spend the vast majority of their time inactive in their lowest power state (Doze). On a synchronous schedule a mote will wake to communicate with another mote. Regularly occurring sequences which wake, perform a significant function and return to sleep are considered atomic. These operations are considered atomic as the sequence of events can not be separated into smaller events while performing a useful function. For example, transmission of a packet over the radio is an atomic operation. Atomic operations may be characterized in either charge or energy. In a time slot where a mote successfully sends a packet, an atomic transmit includes setup prior to sending the message, sending the message, receiving the acknowledgment and the post processing needed as a result of the message being sent. Similarly in a time slot when a mote successfully receives a packet, an atomic receive includes setup prior to listening, listen-

ing until the start of the packet transition, receiving the packet, sending the acknowledge and the post processing required due to the arrival of the packet.

To ensure reliability each mote in the network is provided multiple time slots for each packet it nominally will send and forward. The time slots are assigned to communicate upstream with at least two different motes. When combined with frequency hopping this provides temporal, spatial and spectral redundancy. Given this approach a mote will often listen for a message that it will never receive, since the time slot is not being used by the transmitting mote. It has already successfully transmitted the packet. Since typically 3 timeslots are scheduled for every 1 packet to be sent or forwarded, motes will perform more of these atomic "Idle Listens" than atomic transmit or atomic receive sequences. Examples of transmit, receive and idle listen atomic operations are shown in Figure 7.

TYPICAL PERFORMANCE CHARACTERISTICS

Atomic Operation - Maximum Length Transmit with Acknowledge, 10ms Time Slot (55.9 μ C Total Charge at 3.6V)

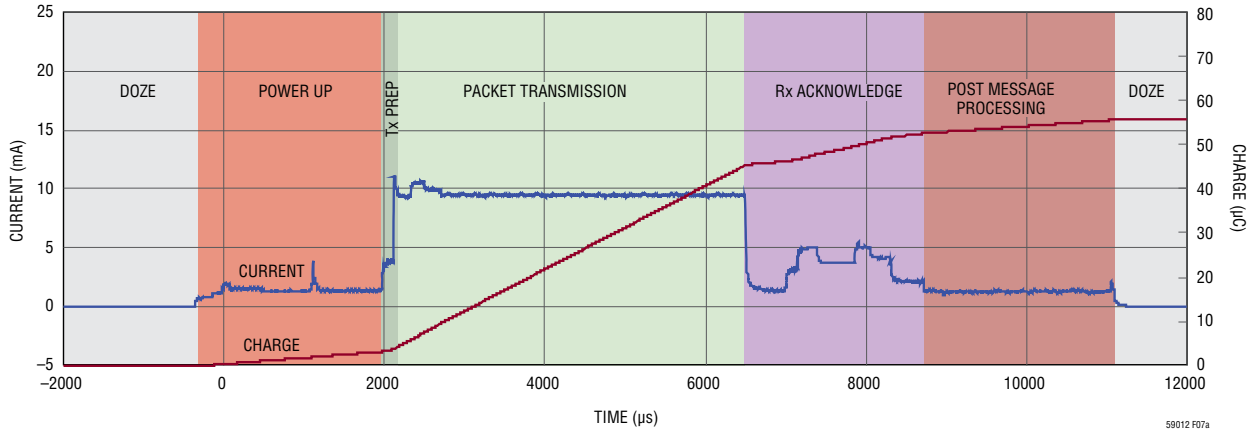

Atomic Operation - Maximum Length Receive with Acknowledge, 10ms Time Slot (39.2 μ C Total Charge at 3.6V)

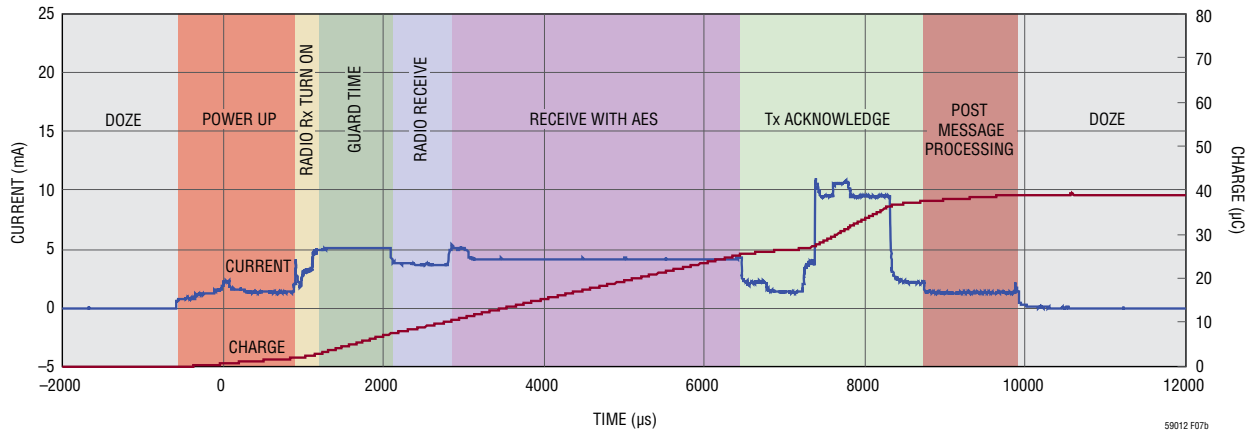

Atomic Operation - Idle Listen, 10ms Time Slot (15.1 μ C Total Charge at 3.6V)

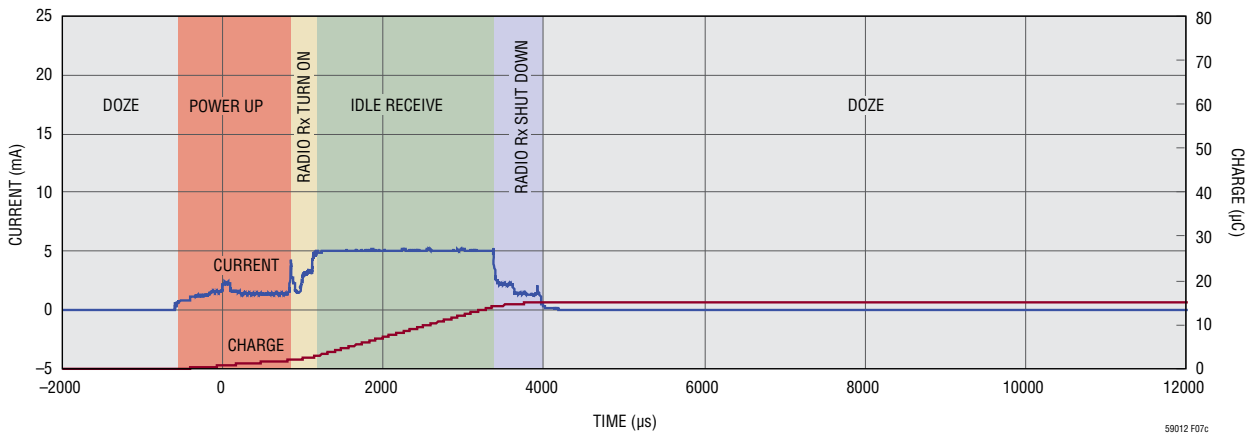

Figure 7

PIN FUNCTIONS Pin functions shown in italics are currently not supported in software.

The following table organizes the pins by functional groups. For those I/O with multiple functions the alternate functions are shown on the second and third line in their respective row. The No column provides the pin number. The second column lists the function. The Type column

lists the I/O type. The I/O column lists the direction of the signal relative to Eterna. The Pull column shows which signals have a fixed passive pull-up or pull-down. The Description column provides a brief signal description.

NO	POWER SUPPLY	TYPE	I/O	PULL	DESCRIPTION
1	GND	Power	-	-	Ground Connection
11	GND	Power	-	-	Ground Connection
20	GND	Power	-	-	Ground Connection
30	GND	Power	-	-	Ground Connection
34	GND	Power	-	-	Ground Connection
37	GND	Power	-	-	Ground Connection
42	GND	Power	-	-	Ground Connection
56	GND	Power	-	-	Ground Connection
66	GND	Power	-	-	Ground Connection
55	VSUPPLY	Power	-	-	Power Supply Input to Eterna

NO	RADIO	TYPE	I/O	PULL	DESCRIPTION
64	RADIO_INHIBIT <i>GPIO15</i>	1 (Note 14)	I <i>I/O</i>	- -	Radio Inhibit <i>General Purpose Digital I/O</i>
4	<i>GPIO17</i>	1	<i>I/O</i>	-	<i>General Purpose Digital I/O</i>
5	<i>GPIO18</i>	1	<i>I/O</i>	-	<i>General Purpose Digital I/O</i>
6	<i>GPIO19</i>	1	<i>I/O</i>	-	<i>General Purpose Digital I/O</i>
-	ANTENNA	N/A	N/A	-	Chip antenna (LTP5901) or MMCX Connector (LPT5902)

NO	ANALOG	TYPE	I/O	PULL	DESCRIPTION
7	AI_2	Analog	I	-	Analog Input 2
8	AI_1	Analog	I	-	Analog Input 1
9	AI_3	Analog	I	-	Analog Input 3
10	AI_0	Analog	I	-	Analog Input 0

NO	RESET	TYPE	I/O	PULL	DESCRIPTION
15	RESETn	1	I	UP	Reset Input, Active Low

NO	JTAG	TYPE	I/O	PULL	DESCRIPTION
16	TDI	1	I	UP	JTAG Test Data In
17	TDO	1	O	-	JTAG Test Data Out
18	TMS	1	I	UP	JTAG Test Mode Select
19	TCK	1	I	DOWN	JTAG Test Clock

LTP5901-WHM/LTP5902-WHM

PIN FUNCTIONS

Pin functions shown in italics are currently not supported in software.

NO	GPIOs (Note 15)	TYPE	I/O	PULL	DESCRIPTION
21	<i>DP4 (GPIO23)</i>	1	<i>I/O</i>	-	<i>General Purpose Digital I/O</i>
25	<i>DP3 (GPIO22)</i> <i>TIMER8_EXT</i>	1	<i>I/O</i> <i>I</i>	- -	<i>General Purpose Digital I/O</i> <i>External Input to 8-Bit Timer/Counter</i>
26	<i>DP2 (GPIO21)</i> <i>LPTIMER_EXT</i>	1	<i>I/O</i> <i>I</i>	- -	<i>General Purpose Digital I/O</i> <i>External Input to Low Power Timer/Counter</i>
28	<i>DP0 (GPIO0)</i> <i>SPIM_SS_2n</i>	1	<i>I/O</i> <i>0</i>	- -	<i>General Purpose Digital I/O</i> <i>SPI Master Slave Select 2, Active Low</i>
45	<i>DP1 (GPIO20)</i> <i>TIMER16_EXT</i>	1	<i>I/O</i> <i>I</i>	- -	<i>General purpose Digital I/O</i> <i>External input to 16-Bit Timer/Counter</i>

NO	SPECIAL PURPOSE	TYPE	I/O	PULL	DESCRIPTION
27	<i>SLEEPn</i>	1 (Note 14)	<i>I</i>	-	<i>Deep Sleep, Active Low</i>
46	<i>PWM0</i> <i>TIMER16_OUT</i> <i>GPIO16</i>	2	<i>0</i> <i>0</i> <i>I/O</i>	- - -	<i>Pulse Width Modulator 0</i> <i>16-bit Timer/Counter Match Output/PWM Output</i> <i>General Purpose Digital I/O</i>
63	<i>TIMEn</i> <i>GPIO1</i>	1 (Note 14)	<i>I</i> <i>I/O</i>	- -	<i>Time Capture Request, Active Low</i> <i>General Purpose Digital I/O</i>

NO	CLI	TYPE	I/O	PULL	DESCRIPTION
31	<i>UART0_TX</i>	2	<i>0</i>	-	<i>CLI UART 0 Transmit</i>
32	<i>UART0_RX</i>	1	<i>I</i>	UP	<i>CLI UART 0 Receive</i>

NO	SPI MASTER	TYPE	I/O	PULL	DESCRIPTION
38	<i>SPIM_MISO</i> <i>GPIO11</i>	1	<i>I</i> <i>I/O</i>	- -	<i>SPI Master (MISO) Master In Slave Out Port</i> <i>General Purpose Digital I/O</i>
40	<i>SPIM_MOSI</i> <i>GPIO10</i>	2	<i>0</i> <i>I/O</i>	- -	<i>SPI Master (MOSI) Master Out Slave In Port</i> <i>General Purpose Digital I/O</i>
41	<i>SPIM_SCK</i> <i>GPIO9</i>	2	<i>0</i> <i>I/O</i>	- -	<i>SPI Master (SCK) Serial Clock Port</i> <i>General Purpose Digital I/O</i>
43	<i>SPIM_SS_1n</i> <i>GPIO13</i>	1	<i>0</i> <i>I/O</i>	- -	<i>SPI Master Slave Select 1, Active Low</i> <i>General Purpose Digital I/O</i>
44	<i>SPIM_SS_0n</i> <i>GPIO12</i>	1	<i>0</i> <i>I/O</i>	- -	<i>SPI Master Slave Select 0, Active Low</i> <i>General Purpose Digital I/O</i>

NO	IPCS SPI/FLASH PROGRAMMING (Note 16)	TYPE	I/O	PULL	DESCRIPTION
33	<i>IPCS_MISO</i> <i>TIMER 16 OUT</i> <i>GPIO6</i>	2	<i>0</i> <i>0</i> <i>I/O</i>	- - -	<i>SPI Flash Emulation (MISO) Master In Slave Out Port</i> <i>16-Bit Timer/Counter Match Output/PWM Output</i> <i>General Purpose Digital I/O</i>
35	<i>IPCS_MISO</i> <i>TIMER 16 OUT</i> <i>GPIO6</i>	1	<i>I</i> <i>I</i> <i>I/O</i>	- - -	<i>SPI Flash Emulation (MOSI) Master Out Slave In Port</i> <i>External Input to 16-Bit Timer/Counter</i> <i>General Purpose Digital I/O</i>
36	<i>IPCS_MISO</i> <i>TIMER 16 OUT</i> <i>GPIO6</i>	1	<i>I</i> <i>I</i> <i>I/O</i>	- - -	<i>SPI Flash Emulation (SCK) Serial Clock Port</i> <i>External Input to 8-Bit Timer/Counter</i> <i>General Purpose Digital I/O</i>
39	<i>IPCS_MISO</i> <i>TIMER 16 OUT</i> <i>GPIO6</i>	1	<i>I</i> <i>I</i> <i>I/O</i>	- - -	<i>SPI Flash Emulation Slave Select, Active Low</i> <i>External Input to Low Power Timer/Counter</i> <i>General Purpose Digital I/O</i>
51	<i>FLASH_P_ENn</i>	1	<i>I</i>	UP	<i>Flash Program Enable, Active low</i>

59012whmfa

PIN FUNCTIONS

Pin functions shown in grey are currently not supported in software.

NO	I ² C/1-Wire/SPI Slave	TYPE	I/O	PULL	DESCRIPTION
47	SPIS_MISO UARTC1_TX 1_WIRE	2	0 0 I/O	- - -	SPI Slave (MISO) Master In Slave Out Port CLI UART 1 Transmit 1 Wire Master
48	SPIS_MOSI UARTC1_RX GPIO26	1	I I I/O	- - -	SPI Slave (MOSI) Master Out Slave In Port CLI UART 1 Receive General Purpose Digital I/O
49	SPIS_SCK SCL	2	I I/O	- -	SPI Slave (SCK) Serial Clock Port I ² C Serial Clock
50	SPIS_SSn SDA	2	I I/O	- -	SPI Slave Select, Active Low I ² C Serial Data

NO	API UART	TYPE	I/O	PULL	DESCRIPTION
57	UART_RX_RTSn	1 (Note 14)	I	-	UART Receive (RTS) Request to Send, Active Low
58	UART_RX_CTSn	1	0	-	UART Receive (CTS) Clear to Send, Active Low
59	UART_RX	1 (Note 14)	I	-	UART Receive
60	UART_TX_RTSn	1	0	-	UART Transmit (RTS) Request to Send, Active Low
61	UART_TX_CTSn	1 (Note 14)	I	-	UART Transmit (CTS) Clear to Send, Active Low
62	UART_TX	2	0	-	UART Transmit

Note 14: These inputs are always enabled and must be driven or pulled to a valid state to avoid leakage.

Note 15: See also pins 33, 35, 36, and 39 for additional GPIO ports.

Note 16: Embedded programming over the IPCS SPI bus is only available when RESETn is asserted.

VSUPPLY: System and I/O power supply. Provides power to the module. The digital-interface I/O voltages are also set by this voltage.

ANTENNA: Multiplexed receiver input and transmitter output pin. The impedance presented to the MMCX connector should be 50Ω, single-ended with respect to ground.

AI_0, AI_1, AI_2, AI_3: Analog Inputs. These pins are multiplexed to the analog input chain. The analog input chain, as shown in Figure 8, is software-configurable and includes a variable-gain amplifier, an offset-DAC for adjusting input range, and a 10b ADC. Valid input range is between 0 to 1.8V.

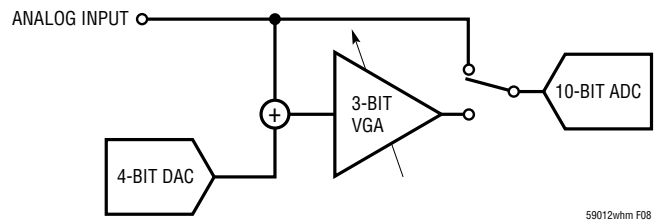

Figure 8. Analog Input Chain

RESETn: The asynchronous reset signal is internally pulled up. Resetting Eterna will result in the ARM Cortex M3 rebooting and loss of network connectivity. Use of this signal for resetting Eterna is not recommended except during power-on and in-circuit programming.

PIN FUNCTIONS

RADIO_INHIBIT: RADIO_INHIBIT provide a mechanism for an external device to temporarily disable radio operation. Failure to observe the timing requirements defined in the Radio_Inhibit AC Characteristics table, may result in unreliable network operation. In designs where the RADIO_INHIBIT function is not needed the input must either be tied, pulled or actively driven low to avoid excess leakage.

TMS, TCK, TDI, TDO: JTAG Port Supporting Software Debug and Boundary Scan.

SLEEPn: The SLEEPn function is not currently supported in software. The SLEEPn input must either be tied, pulled or actively driven high to avoid excess leakage.

UART_RX, UART_RX_RTSn, UART_RX_CTSn, UART_TX, UART_TX_RTSn, UART_TX_CTSn: The API UART interface includes bi-directional wake up and flow control. Unused input signals must be driven or pulled to their inactive state.

TIMEn: Strobing the TIMEn input is the most accurate method to acquire the network time maintained by Eterna. Eterna latches the network timestamp with sub-microsecond resolution on the rising edge of the TIMEn signal and produces a packet on the API serial port containing the timing information.

UARTCO_RX, UARTCO_TX: The CLI UART provides a mechanism for monitoring, configuration and control of Eterna during operation. For a complete description of the supported commands see the SmartMesh WirelessHART Mote CLI API Guide.

FLASH_P_ENn, IPCS_SSn, IPCS_SCK, IPCS_MISO, IPCS_SSn: The In-circuit Programming Control System (IPCS) bus enables in-circuit programming of Eterna's flash memory. IPCS_SCK is a clock and should be terminated appropriately for the driving source to prevent overshoot and ringing.

OPERATION

The LTP5901/LTP5902 is the world's most energy-efficient IEEE 802.15.4 compliant platform, enabling battery and energy harvested applications. With a powerful 32-bit ARM Cortex™-M3, best-in-class radio, flash, RAM and purpose-built peripherals, Eterna provides a flexible, scalable and robust networking solution for applications demanding minimal energy consumption and data reliability in even the most challenging RF environments.

Shown in Figure 9, Eterna integrates purpose-built peripherals that excel in both low operating-energy consumption and the ability to rapidly and precisely cycle between operating and low-power states. Items in the gray shaded region labeled "Analog Core" correspond to the analog/RF components.

POWER SUPPLY

Eterna is powered from a single pin, VSUPPLY, which powers the I/O cells and is also used to generate internal supplies. Eterna's two on-chip DC/DC converters minimize Eterna's energy consumption while the device is awake. To conserve power the DC/DC converters are disabled when the device is in low-power state. Eterna's power supply conditioning architecture, including the two integrated DC/DC converters and three integrated low-dropout regulators, provides excellent rejection of supply noise. Eterna's operating supply voltage range is high enough to support direct connection to lithium-thionyl chloride Li-SOCl₂ sources and wide enough to support battery operation over a broad temperature range.

SUPPLY MONITORING AND RESET

Eterna integrates a Power-on reset (PoR) circuit. As the RESETn input pin is nominally configured with an internal pull-up resistor, no connection is required. For a graceful shutdown, the software and the networking layers should be cleanly halted via API commands prior to assertion of the RESETn pin. See the SmartMesh WirelessHART Mote API Guide for details on the disconnect and reset commands. Eterna includes a soft brown-out monitor that fully protects the flash from corruption in the event that power is removed while writing to flash. Integrated flash supervisory functionality, in conjunction with a fault tolerant file system, yields a robust non-volatile storage solution.

PRECISION TIMING

A major feature of Eterna over competing 802.15.4 product offerings is its low-power dedicated timing hardware and timing algorithms. This functionality provides timing precision two to three orders of magnitude better than any other low-power solution available at the time of publication. Improved timing accuracy allows motes to minimize the amount of radio listening time required to ensure packet reception thereby lowering even further the power consumed by SmartMesh networks. Eterna's patented timing hardware and timing algorithms provide superior performance over rapid temperature changes, further differentiating Eterna's reliability when compared with other wireless products. In addition, precise timing enables networks to reduce spectral dead time, increasing total network throughput.

OPERATION

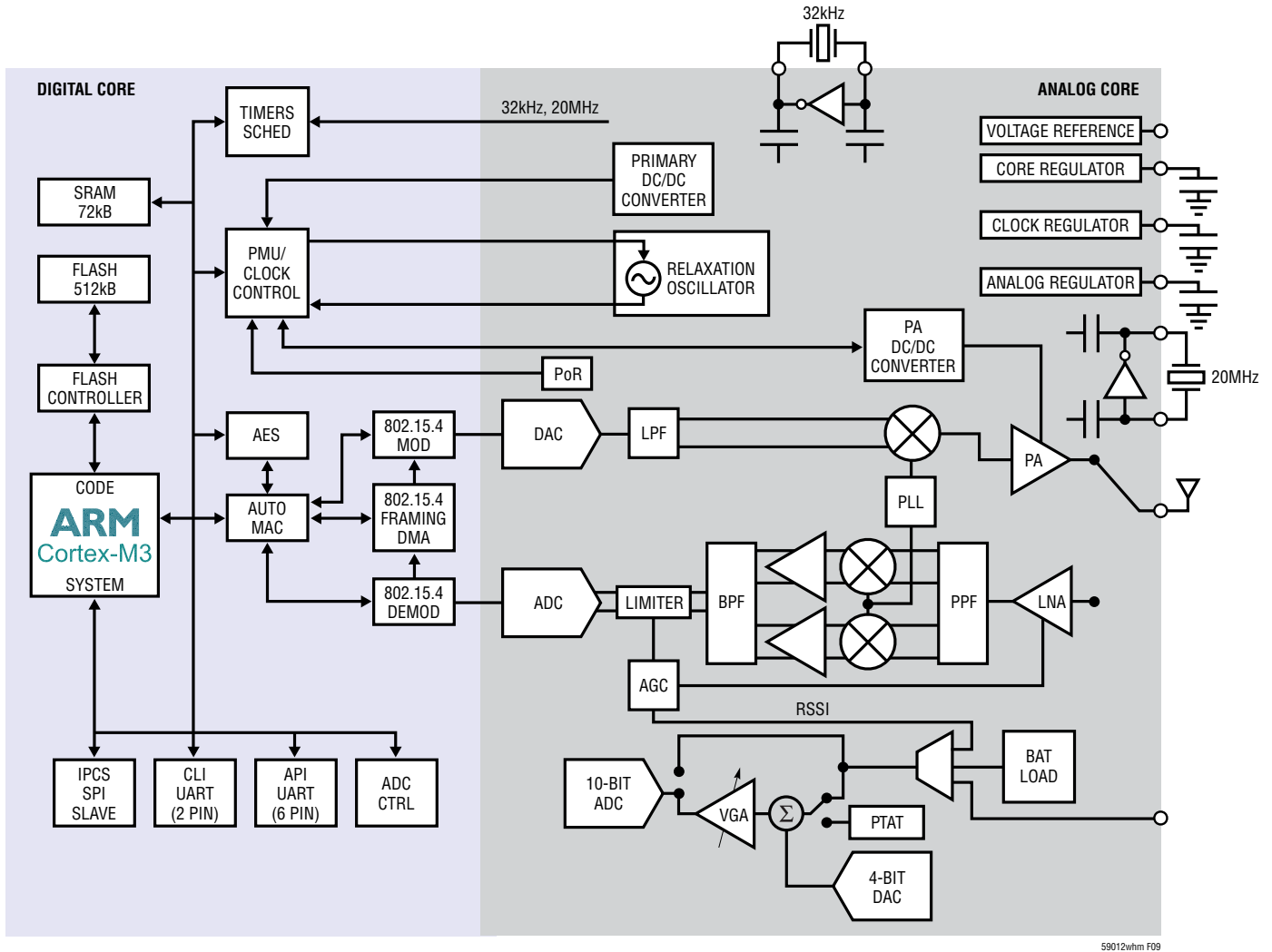

Figure 9. Eterna Block Diagram

OPERATION

APPLICATION TIME SYNCHRONIZATION

In addition to coordinating timeslots across the network, which is transparent to the user, Eterna's timing management is used to support two mechanisms to share network time. Having an accurate, shared, network-wide time base enables events to be accurately time stamped or tasks to be performed in a synchronized fashion across a network. Eterna will send a time packet through its serial interface when one of the following occurs:

- Eterna receives an API request to read time
- The TIMEn signal is asserted

The use of TIMEn has the advantage of being more accurate. The value of the timestamp is captured in hardware relative to the rising edge of TIMEn. If an API request is used, due to packet processing, the value of the timestamp may be captured several milliseconds after receipt of the packet due to packet processing. See the TIMEn AC Characteristics section for the time function's definition and specifications.

TIME REFERENCES

Eterna includes three clock sources: an internal relaxation oscillator, a low power oscillator designed for a 32.768kHz crystal, and the radio reference oscillator designed for a 20MHz crystal.

Relaxation Oscillator

The relaxation oscillator is the primary clock source for Eterna, providing the clock for the CPU, memory subsystems, and all peripherals. The internal relaxation oscillator is dynamically calibrated to 7.3728 MHz. The internal relaxation oscillator typically starts up in a few μ s, providing an expedient, low-energy method for duty cycling between active and low power states. Quick start-up from the doze state, defined in the State Diagram section, allows Eterna to wake up and receive data over the UART and SPI interfaces by simply detecting activity on the appropriate signals.

32.768kHz Crystal

Once Eterna is powered up and the 32.768kHz crystal source has begun oscillating, the 32.768kHz crystal remains operational while in the Active state, and is used as the timing basis when in Doze state. See the State Diagram section for a description of Eterna's operational states.

20MHz Crystal

The 20MHz crystal source provides a frequency reference for the radio, and is automatically enabled and disabled by Eterna as needed.

RADIO

Eterna includes the lowest-power commercially available 2.4GHz IEEE 802.15.4e radio by a substantial margin. (Please refer to the Radio Specifications section for power consumption numbers.) Eterna's integrated power amplifier is calibrated and temperature-compensated to consistently provide power at a limit suitable for worldwide radio certifications. Additionally, Eterna uniquely includes a hardware-based autonomous MAC that handles precise sequencing of peripherals, including the transmitter, the receiver, and Advanced Encryption Standard (AES) peripherals. The hardware-based autonomous Media Access Controller (MAC) minimizes CPU activity, thereby further decreasing power consumption.

UARTS

The principal network interface is through the application programming interface (API) UART. A command-line interface (CLI) is also provided for support of test and debug functions. Both UARTs sense activity continuously, consuming virtually no power until data is transferred over the port and then automatically returning to their lowest power state after the conclusion of a transfer. The definition for packet encoding on the API UART interface can be found in the [SmartMesh WirelessHART Mote API Guide](#) and the CLI command definitions can be found in the [SmartMesh WirelessHART Mote CLI Guide](#).

OPERATION

API UART Protocol

The API UART protocol was created with the goal of supporting a wide range of companion Multipoint Control Units (MCUs) while reducing power consumption of the system. The receive half of the API UART protocol includes two additional signals in addition to UART_RX: UART_RX_RTSn and UART_RX_CTSn. The transmit half of the API UART protocol includes two additional signals in addition to UART_TX: UART_TX_RTSn and UART_TX_CTSn. The API UART protocol is referred to as Mode 4.

In the Figures accompanying the protocol descriptions, signals driven by the companion processor are drawn in black and signals driven by Eterna are drawn in blue.

UART Mode 4

UART Mode 4 incorporates level-sensitive flow control on the TX channel and requires no flow control on the RX channel, supporting 115200 baud. The use of level-sensitive flow control signals enables data rates above 9600 baud with the option of using a reduced set of the flow control signals; however, Mode 4 has specific limitations. First, the use of the RX flow control signals (UART_RX_RTSn and UART_RX_CTSn) for Mode 4 are optional provided the use is limited to the industrial temperature range (-40°C to 85°C); otherwise, the flow control is mandatory. If RX flow control signals are not used, UART_RX_RTSn should be tied to VSUPPLY (inactive) and UART_RX_CTSn should be left unconnected. Second, unless the companion processor is always ready to receive a packet, the companion processor must negate UART_TX_CTSn prior to the end of the current. Failure to negate UART_TX_CTSn prior to the end of a packet may result in back to back packets. Third, the companion processor must wait at least $t_{\text{RX_RTS}}$ to RX_CTS between transmitting packets. See the [UART AC Characteristics](#) section for complete timing specifications. Packets are HDLC encoded with one stop bit and no parity bit. The use of the RX flow control signals (UART_RX_RTSn and UART_RX_CTSn) for Mode 4 are optional. The flow control signals for the TX channel are shown in Figure 10. Transfers are initiated by Eterna asserting UART_TX_RTSn.

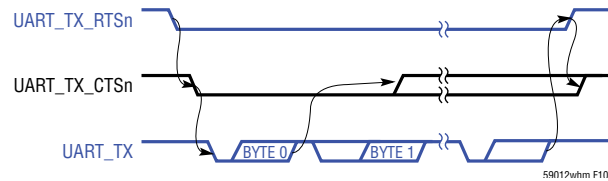

Figure 10. UART Mode 4 Transmit Flow Control

The UART_TX_CTSn signal may be actively driven by the companion processor when ready to receive a packet or UART_TX_CTSn may be tied low if the companion processor is always ready to receive a packet. After detecting a logic '0' on UART_TX_CTSn Eterna sends the entire packet. Following the transmission of the final byte in the packet Eterna negates UART_TX_RTSn and waits for $t_{\text{TX_INTERPACKET}}$, defined in the [UART AC Characteristics](#) section before asserting UART_TX_RTSn again.

For details on the timing of the UART protocol, see the [UART AC Characteristics](#) section.

CLI UART

The Command Line Interface (CLI) UART port is a two wire protocol (TX and RX) that operates at a fixed 9600 baud rate with one stop bit and no parity. The CLI UART interface is intended to support command line instructions and response activity.

AUTONOMOUS MAC

Eterna was designed as a system solution to provide a reliable, ultra-low power, and secure network. A reliable network capable of dynamically optimizing operation over changing environments requires solutions that are far too complex to completely support through hardware acceleration alone. As described in the Precision Timing section, proper time management is essential for optimizing a solution that is both low power and reliable. To address these requirements Eterna includes the Autonomous MAC, which incorporates a co-processor for controlling all of the time-critical radio operations. The Autonomous MAC provides two benefits: first, preventing variable software latency from affecting network timing and second, greatly

OPERATION

reducing system power consumption by allowing the CPU to remain inactive during the majority of the radio activity. The Autonomous MAC, provides software-independent timing control of the radio and radio-related functions, resulting in superior reliability and exceptionally low power.

SECURITY

Network security is an often overlooked component of a complete network solution. Proper implementation of security protocols is significant in terms of both engineering effort and market value in an OEM product. Eterna system solutions provide a FIPS-197 validated encryption scheme that includes authentication and encryption at the MAC and network layers with separate keys for each mote. This not only yields end-to-end security, but if a mote is somehow compromised, communication from other motes is still secure. A mechanism for secure key exchange allows keys to be kept fresh. To prevent physical attacks, Eterna includes hardware support for electronically locking devices, thereby preventing access to Eterna's flash and RAM memory and thus the keys and code stored therein.

TEMPERATURE SENSOR

Eterna includes a calibrated temperature sensor on chip. The temperature readings are available locally through Eterna's serial API, in addition to being available via the network manager. The performance characteristics of the temperature sensor can be found in the Temperature Sensor Characteristics section.

RADIO INHIBIT

The RADIO_INHIBIT input enables an external controller to temporarily disable the radio software drivers (for example, to take a sensor reading that is susceptible to radio interference). When RADIO_INHIBIT is asserted the software radio drivers will disallow radio operations including clear channel assessment, packet transmits, or packet receipts. If the radio is active in the current timeslot when RADIO_INHIBIT is asserted the radio will be disabled after the present operation completes. For details on the timing associated with RADIO_INHIBIT, see the RADIO_INHIBIT AC Characteristics section.

SOFTWARE INSTALLATION

Devices are supplied with the flash erased, requiring programming as part of the OEMs manufacturing procedure. The US Department of Commerce places restrictions on export of systems and software supporting encryption. All of Linear/Dust product software produced to date contains encryption and is subject to [export regulations](#) and may be provided only via [MyLinear](#), <https://www.linear.com/mylinear>. Customers purchasing SmartMesh products will receive a certificate containing a registration key and registration instructions with their order. After registering with the key, customers will be able to download SmartMesh software images from [MyLinear](#). Once registered, customers will receive automated e-mail notifications as software updates are made available.

Linear Technology offers the [DC9010](#), in circuit programmer for the Eterna based products. While the [DC9010](#), is provided as a finished product, the design documents are provided as a reference for customers.

Once software has been loaded, devices can be configured via either the CLI or API ports. Configuration commands and settings are defined in [SmartMesh WirelessHART Mote API Guide](#) and [SmartMesh WirelessHART Mote CLI Guide](#).

FLASH DATA RETENTION

Eterna contains internal flash (Non-Volatile Memory) to store calibration results, unique ID, configuration settings and software images. Flash retention over the operating temperature range. See Electrical Characteristics and Absolute Maximum Ratings sections.

Non destructive storage above the operating temperature range of -40°C to 85°C is possible; although, this may result in a degradation of retention characteristics.

The degradation in flash retention for temperatures $>85^{\circ}\text{C}$ can be approximated by calculating the dimensionless acceleration factor using the following equation:

$$AF = e^{\left[\left(\frac{E_a}{k} \right) \left(\frac{1}{T_{USE}+273} - \frac{1}{T_{STRESS}+273} \right) \right]}$$

OPERATION

Where:

AF = acceleration factor

E_a = activation energy = 0.6eV

$k = 8.625 \cdot 10^{-5} \text{eV}/^\circ\text{K}$

T_{USE} = is the specified temperature retention in $^\circ\text{C}$

T_{STRESS} = actual storage temperature in $^\circ\text{C}$

Example: Calculate the effect on retention when storing at a temperature of 105°C .

$T_{\text{STRESS}} = 105^\circ\text{C}$

$T_{\text{USE}} = 85^\circ\text{C}$

AF = 2.8

So the overall retention of the flash would be degraded by a factor of 2.8, reducing data retention from 20 years at 85°C to 7.1 years at 105°C .

STATE DIAGRAM

In order to provide capabilities and flexibility in addition to ultra low power, Eterna operates in various states, as shown in Figure 11. State transitions shown in red are not recommended.

Start Up

Start Up occurs as a result of either crossing the Power-on reset threshold or asserting RESETn. After the completion of Power-on reset or the falling edge of an internally synchronized RESETn, Eterna loads its Fuse Table which, as described in the previous section, includes setting I/O direction. In this state, Eterna checks the state of the FLASH_P_ENn and RESETn and enters the serial flash emulation mode if both signals are asserted. If the FLASH_P_ENn pin is not asserted but RESETn is asserted, Eterna automatically reduces its energy consumption to a minimum until RESETn is released. Once RESETn is de-asserted, Eterna goes through a boot sequence, and then enters the Active state.

Serial Flash Emulation

When both RESETn and FLASH_P_ENn are asserted, Eterna disables normal operation and enters a mode to emulate the operation of a serial flash. In this mode, its flash can be programmed.

Operation

Once Eterna has completed startup, Eterna transitions to the Operational group of states (active/CPU active, active/CPU inactive, and Doze). There, Eterna cycles between the various states, automatically selecting the lowest possible power state while fulfilling the demands of network operation.

Active State

In the Active State, Eterna's relaxation oscillator is running and peripherals are enabled as needed. The ARM Cortex-M3 cycles between CPU-active and CPU-inactive (referred to in the ARM Cortex-M3 literature as "Sleep Now" mode). Eterna's extensive use of DMA and intelligent peripherals that independently move Eterna between Active State and Doze State minimizes the time the CPU is active, significantly reducing Eterna's energy consumption.

Doze State

The Doze State consumes orders of magnitude less current than the Active State and is entered when all of the peripherals and the CPU are inactive. In the Doze State Eterna's full state is retained, timing is maintained, and Eterna is configured to detect, wake, and rapidly respond to activity on I/Os (such as UART signals and the TIMEn pin). In the Doze State the 32.768kHz oscillator and associated timers are active.

OPERATION

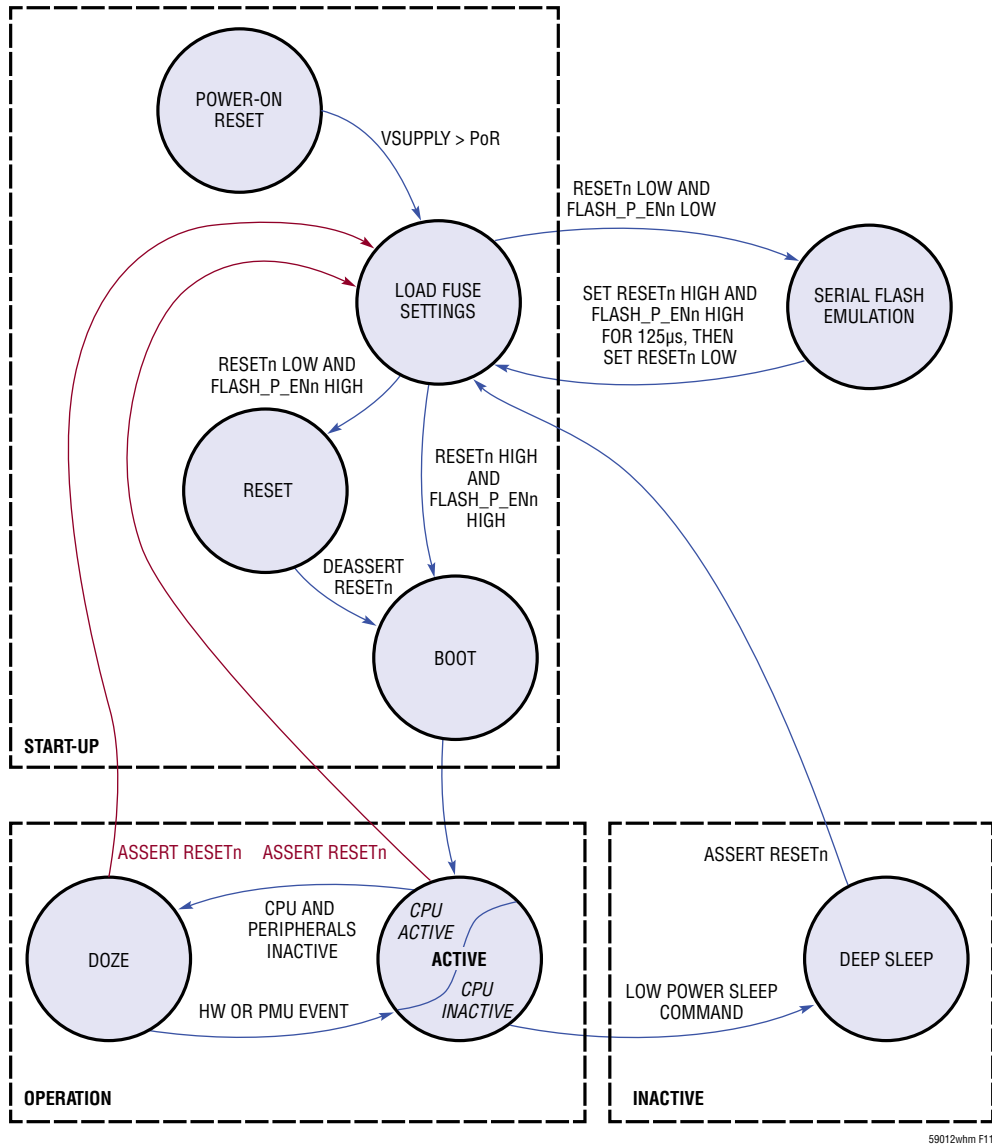

Figure 11. Eterna State Diagram

APPLICATIONS INFORMATION

REGULATORY AND STANDARDS COMPLIANCE

Radio Certification

The LTP5901 and LTP5902 have been certified under a single modular certification, with the module name of ETERNA2. Following the regulatory requirements provided in the [ETERNA2 User's Guide](#) enables customers to ship products in the supported geographies, by simply completing an unintentional radiator scan of the finished product(s). The [ETERNA2 User's Guide](#) also provides the technical information needed to enable customers to further certify either the modules or products based upon the modules in geographies that have not or do not support modular certification.

Compliance to Restriction of Hazardous Substances (RoHS)

Restriction of Hazardous Substances 2 (RoHS 2) is a directive that places maximum concentration limits on the use of certain hazardous substances in electrical and electronic equipment. Linear Technology is committed to meeting the requirements of the European Community directive 2011/65/EU.

This product has been specifically designed to utilize RoHS-compliant materials and to eliminate or reduce the use of restricted materials to comply with 2011/65/EU.

The RoHS-compliant design features include:

- RoHS-compliant solder for solder joints
- RoHS-compliant base metal alloys
- RoHS-compliant precious metal plating
- RoHS-compliant cable assemblies and connector choices
- Lead-free QFN package
- Halogen-free mold compound
- RoHS-compliant and 245 °C re-flow compatible

Note: Customers may elect to use certain types of lead-free solder alloys in accordance with the European Community directive 2011/65/EU. Depending on the type of solder paste chosen, a corresponding process change to optimize reflow temperatures may be required.

SOLDERING INFORMATION

The LTP5901 and LTP5902 are suitable for both eutectic PbSn and RoHS-6 reflow. The maximum reflow soldering temperature is 260°C. A more detailed description of layout recommendations, assembly procedures and design considerations is included in the [LTP5901 and LTP5902 Hardware Integration Guide](#).

RELATED DOCUMENTATION

TITLE	LOCATION	DESCRIPTION
SmartMesh WirelessHART User Guide	http://www.linear.com/docs/41887	The user's guide provides theory of operation, and details of the services supported
SmartMesh WirelessHART Mote API Guide	http://www.linear.com/docs/41893	Definitions of the applications interface commands available over the API UART
SmartMesh WirelessHART Mote CLI Guide	http://www.linear.com/docs/41892	Definitions of the command line interface commands available over the CLI UART
LTP5901 and LTP5902 Hardware Integration Guide	http://www.linear.com/docs/41877	Recommended practices for designing with the LTP5901 and LTP5902
ETERNA2 User's Guide	http://www.linear.com/docs/42916	The ETERNA2 module user's guide includes certification requirements applicable to certified geographies and support documentation enabling customer certification in additional geographies for the LTP5901 and LTP5902

PACKAGE DESCRIPTION

Please refer to <http://www.linear.com/product/LTP5901-WHM#packaging> for the most recent package drawings.

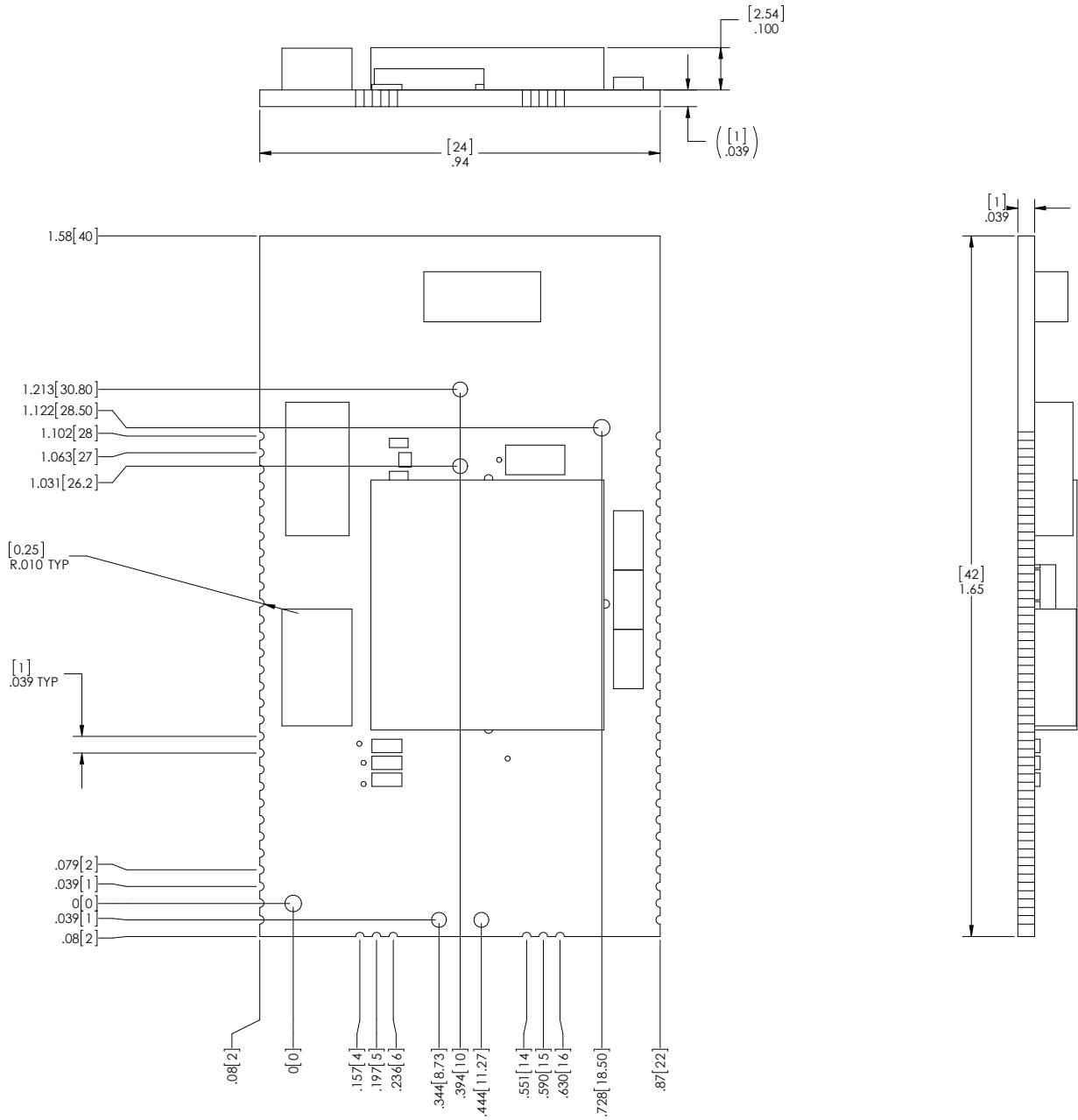

Figure 12. LTP5901 Mechanical Drawing

LTP5901-WHM/LTP5902-WHM

PACKAGE DESCRIPTION

Please refer to <http://www.linear.com/product/LTP5902-WHM#packaging> for the most recent package drawings.

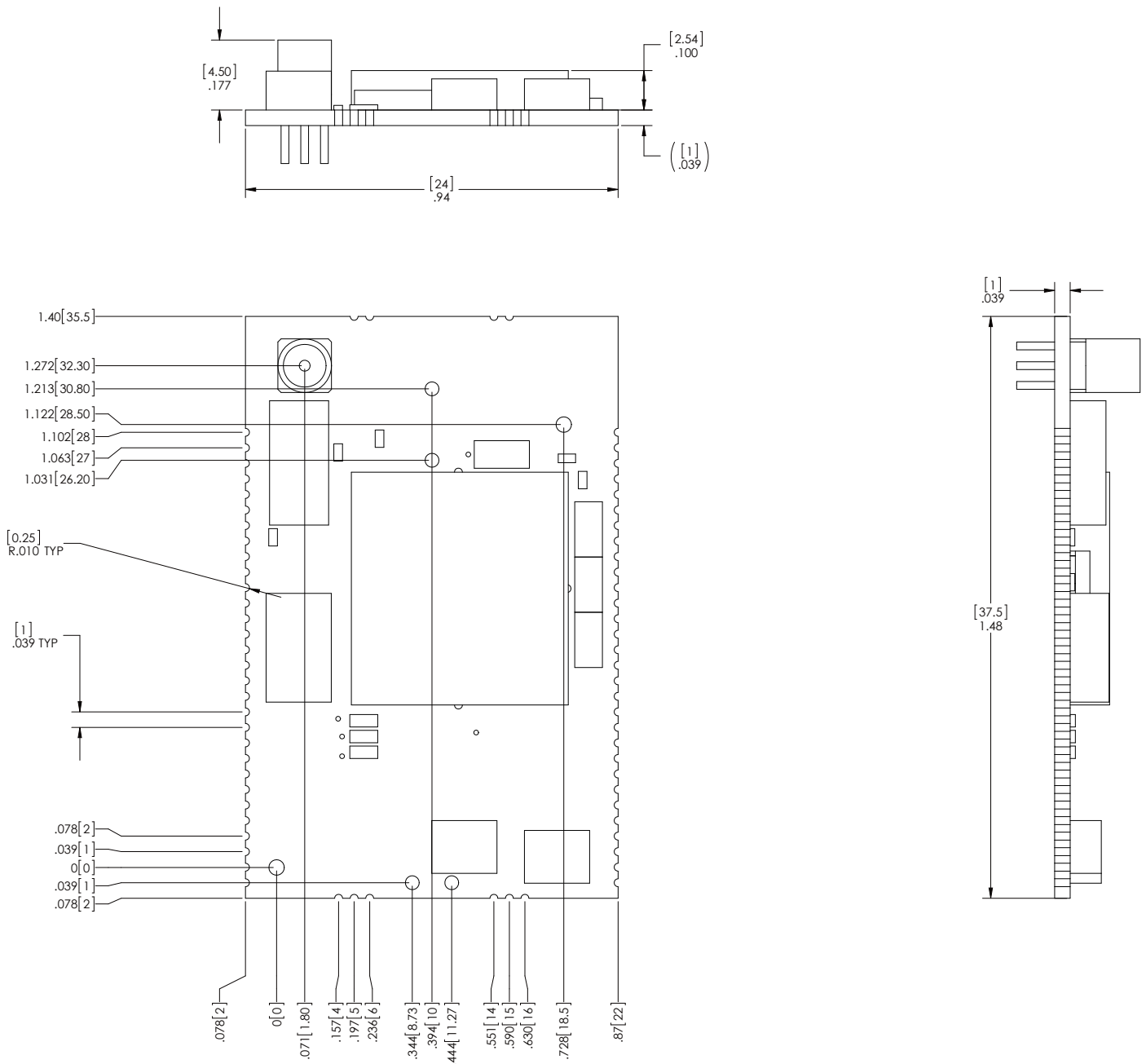

Figure 13. LTP5902 Mechanical Drawing

REVISION HISTORY

REV	DATE	DESCRIPTION	PAGE NUMBER
A	11/15	Updated ordering part numbers	5
		Added total inductance, capacitance	8
		Added Software Installation section	25