



FEATURES



April 2010

- * Current transfer ratio
(CTR : MIN. 20% at $I_F = 1\text{mA}$, $V_{CE} = 5\text{V}$)
- * Isolation voltage between input and output LTV-214 / 224 / 244 Series
($V_{iso} = 3.75\text{KVrms}$)
- * Employs double transfer mold technology

- * Safety approved
UL, CSA, FIMKO, VDE* (* Requires "V" ordering option)

- * RoHS compliance

APPLICATIONS

- * Hybrid substrates that require high density mounting.
- * Programmable controllers
- * System appliances, measuring instruments

OUTLINE DIMENSIONS

LTV-214 :

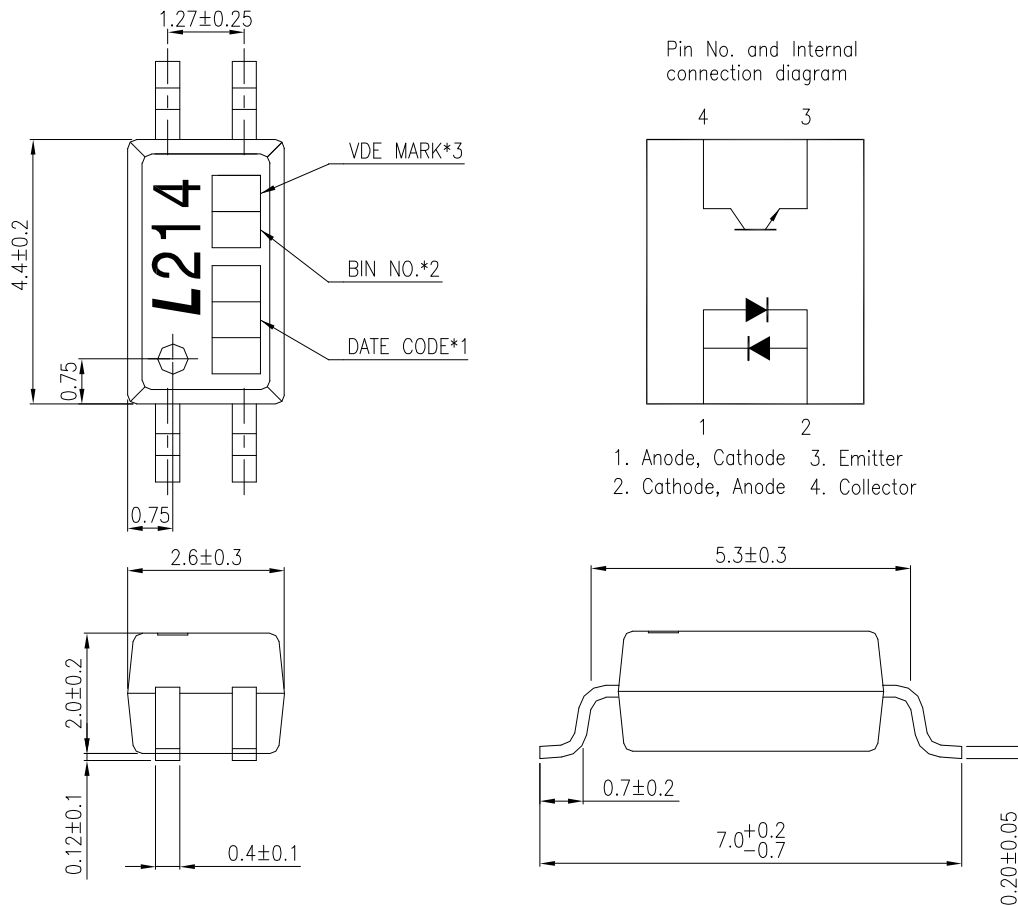

- *1. 3-digit date code: Y WW
Y : Year code (Ex. A: 2010)
WW : Week code (Ex. 01 : the 1st week in that year)
- *2. Rank shall be or shall not be marked.
- *3. VDE mark only appears on devices ordered "V" option.

OUTLINE DIMENSIONS

LTV-224:

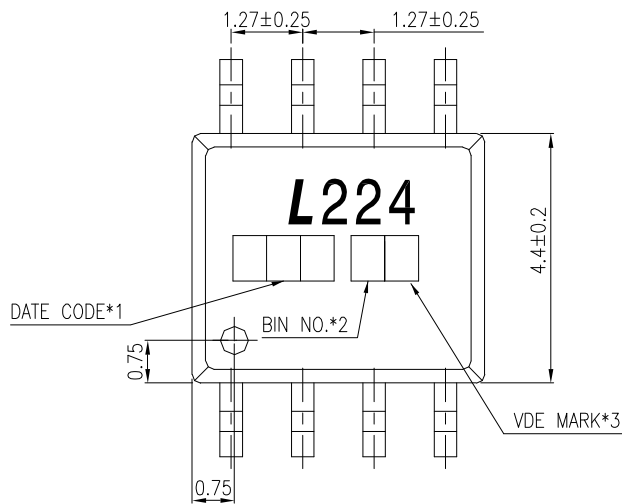

Pin No. and Internal connection diagram

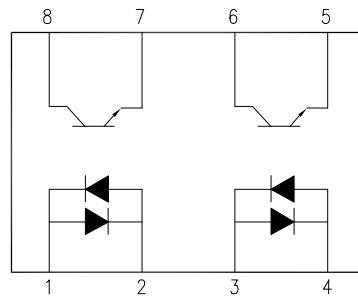

1,3. Anode, Cathode 5,7. Emitter
2,4. Cathode, Anode 6,8. Collector

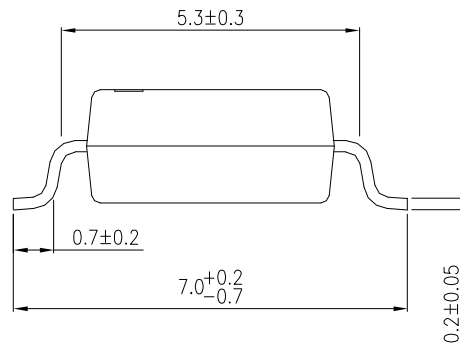
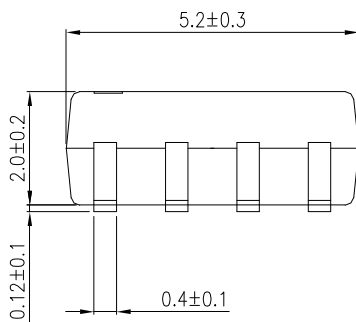

*1. 3-digit date code: Y WW

Y : Year code (Ex. A: 2010)

WW : Week code (Ex. 01 : the 1st week in that year)

*2. Rank shall be or shall not be marked.

*3. VDE mark only appears on devices ordered "V" option.

OUTLINE DIMENSIONS

LTV-244 :

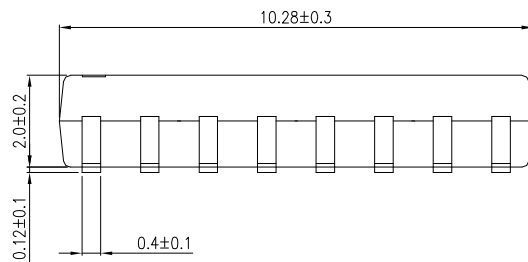
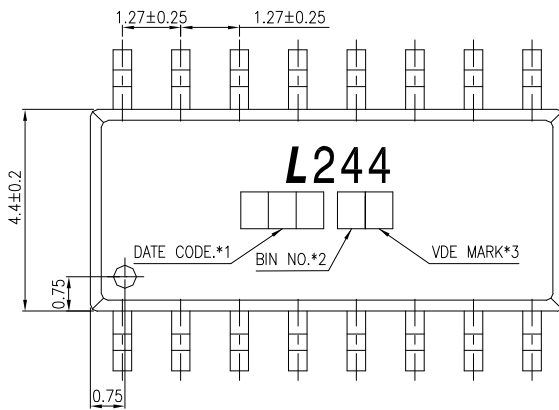

PIN NO. AND INTERNAL CONNECTION DIAGRAM

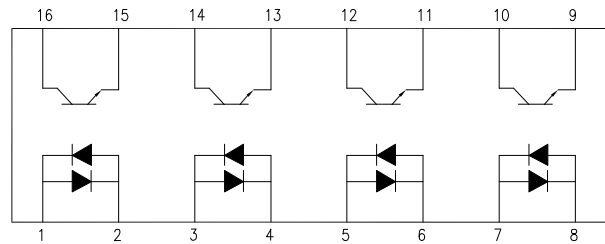

1,3,5,7. Anode,Cathode 9,11,13,15. Emitter
 2,4,6,8. Cathode,Anode 10,12,14,16. Collector

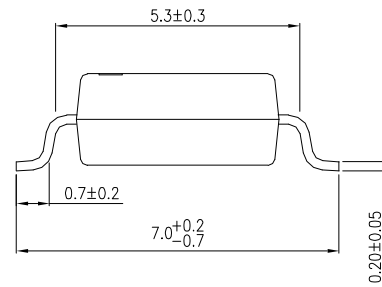

- *1. 3-digit date code: Y WW
 Y : Year code (Ex. A: 2010)
 WW : Week code (Ex. 01 : the 1st week in that year)
- *2. Rank shall be or shall not be marked.
- *3. VDE mark only appears on devices ordered "V" option.

TAPING DIMENSIONS

LTV-214 series:

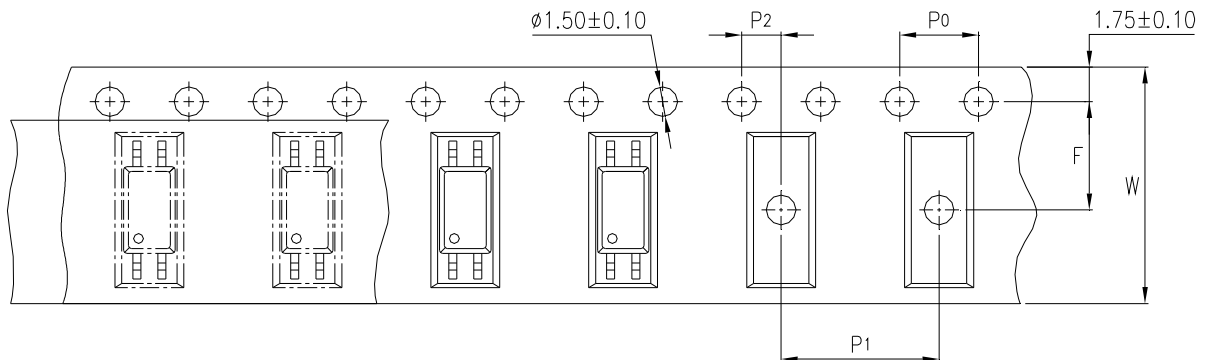

LTV-214-TP1 series

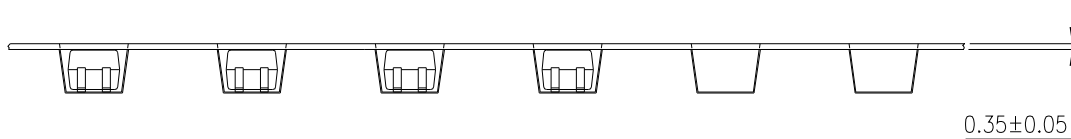
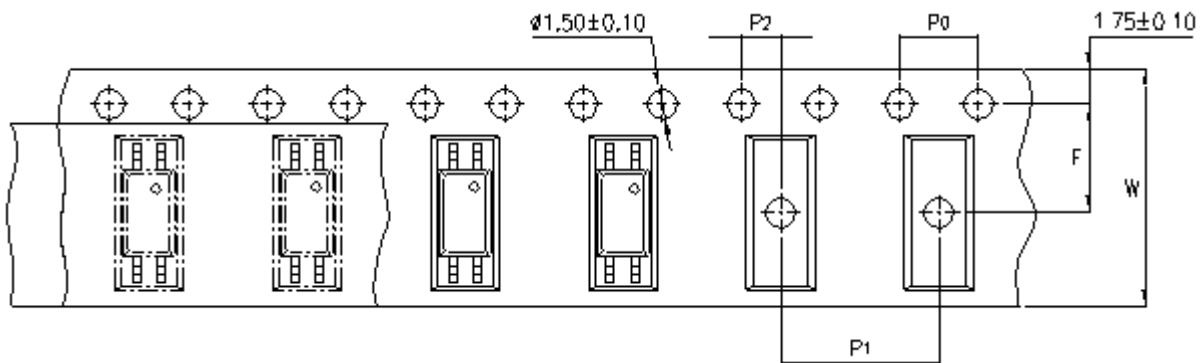

Description	Symbol	Dimension in mm (inches)
Tape wide	W	12 ± 0.3 (.47)
Pitch of sprocket holes	P ₀	4 ± 0.1 (.15)
Distance of compartment	F	5.5 ± 0.1 (.217)
Distance of compartment to compartment	P ₂	2 ± 0.1 (.079)
Distance of compartment to compartment	P ₁	8 ± 0.1 (.315)

TAPING DIMENSIONS

LTV-224 series

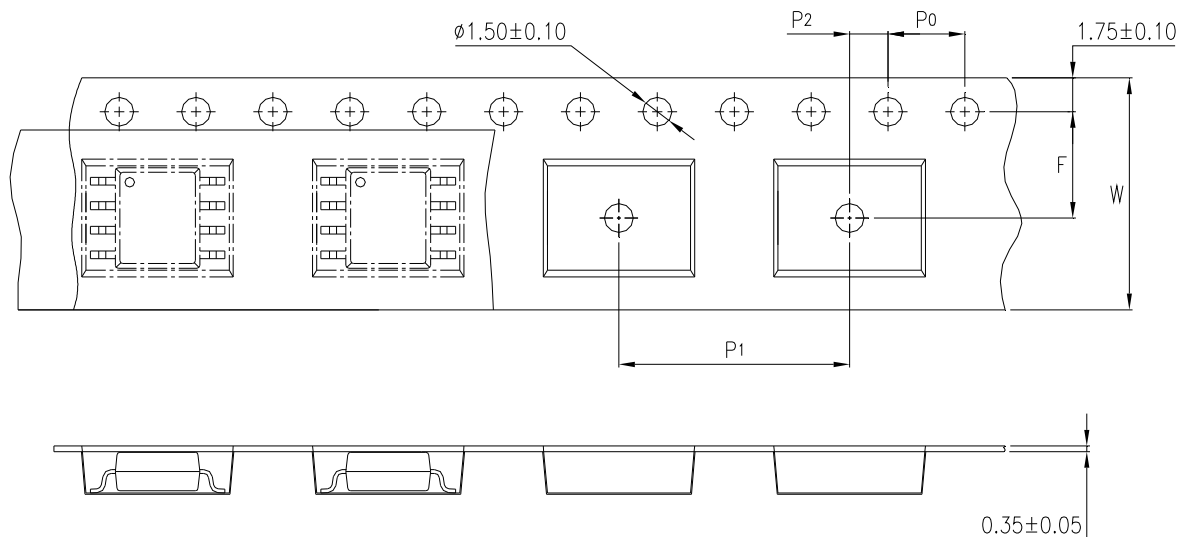

Description	Symbol	Dimension in mm (inches)
Tape wide	W	12 ± 0.3 (.47)
Pitch of sprocket holes	P ₀	4 ± 0.1 (.15)
Distance of compartment	F P ₂	5.5 ± 0.1 (.217) 2 ± 0.1 (.079)
Distance of compartment to compartment	P ₁	8 ± 0.1 (.315)

TAPING DIMENSIONS

LTV-244 series

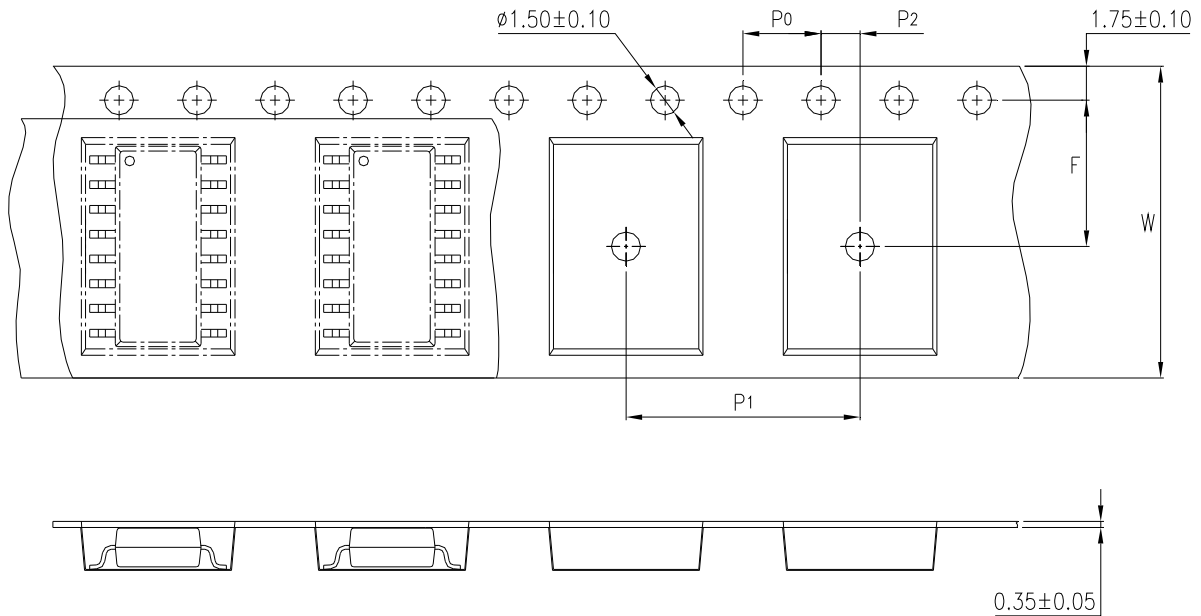

Description	Symbol	Dimension in mm (inches)
Tape wide	W	16 ± 0.3 (.47)
Pitch of sprocket holes	P ₀	4 ± 0.1 (.15)
Distance of compartment	F	7.5 ± 0.1 (.217)
	P ₂	2 ± 0.1 (.079)
Distance of compartment to compartment	P ₁	12 ± 0.1 (.63)

Quantities per Reel :

Package Type	LTV-214	LTV-224	LTV-244
Quantities (pcs)	3000	2000	2000

ABSOLUTE MAXIMUM RATING

(Ta = 25°C)

PARAMETER		SYMBOL	RATING			UNIT
			214	224	244	
INPUT	Forward Current	I _F	50			mA
	Reverse Voltage	V _R	6			V
	Power Dissipation	P	70			mW
OUTPUT	Collector - Emitter Voltage	V _{CEO}	80			V
	Emitter - Collector Voltage	V _{ECO}	7			V
	Collector Current	I _C	50			mA
	Collector Power Dissipation	P _C	150	100		mW
Total Power Dissipation		P _{tot}	200	170		mW
*1	Isolation Voltage	V _{iso}	3,750			V _{rms}
Operating Temperature		T _{opr}	-55 ~ +110			°C
Storage Temperature		T _{stg}	-55 ~ +150			°C
*2	Soldering Temperature	T _{sol}	260 (10s)			°C

*1. AC For 1 Minute, R.H. = 40 ~ 60%

Isolation voltage shall be measured using the following method.

- (1) Short between anode and cathode on the primary side and between collector and emitter on the secondary side.
- (2) The isolation voltage tester with zero-cross circuit shall be used.
- (3) The waveform of applied voltage shall be a sine wave.

*2. For 10 Seconds

ELECTRICAL - OPTICAL CHARACTERISTICS

(Ta = 25°C)

PARAMETER		SYMBOL	MIN.	TYP.	MAX.	UNIT	CONDITIONS
INPUT	Forward Voltage	V _F	—	1.2	1.4	V	I _F =20mA
	Terminal Capacitance	C _t	—	60	—	pF	V=0, f=1KHz
OUTPUT	Collector Dark Current	I _{CEO}	—	—	100	nA	V _{CE} =48V, I _F =0
	Collector-Emitter Breakdown Voltage	BV _{CEO}	80	—	—	V	I _C =0.1mA I _F =0
	Emitter-Collector Breakdown Voltage	BV _{ECO}	7	—	—	V	I _E =10μA I _F =0
TRANSFER CHARACTERISTICS	Collector Current	I _C	0.2	—	4	mA	I _F =±1mA
	*1 Current Transfer Ratio	CTR	20	—	400	%	V _{CE} =5V
	Saturated Current	I _C (sat)	—	4.8	—	mA	I _F =8mA
	Saturated CTR	CTR (sat)	—	60	—	%	V _{CE} =2.4V
	Collector-Emitter Saturation Voltage	V _{CE(sat)}	—	—	0.4	V	I _F =8mA I _C =2.4mA
	Isolation Resistance	R _{iso}	5×10 ¹⁰	1×10 ¹¹	—	Ω	DC500V 40 ~ 60% R.H.
	Floating Capacitance	C _f	—	0.6	1	pF	V=0, f=1MHz
	Response Time (Rise)	t _r	—	2	—	μs	V _{CE} =10V, I _C =2mA R _L =100Ω
	Response Time (Fall)	t _f	—	3	—	μs	
	Turn-On Time	t _{on}	—	3	—	us	
	Turn-Off Time	t _{off}	—	3	—	us	
	Turn-On Time	t _{ON}	—	2	—	us	
	Storage Time	t _s	—	25	—	us	V _{CE} =5V, I _C =16mA R _L =1.9KΩ
Turn-Off Time	t _{OFF}	—	40	—	us		

$$*1 \text{ CTR} = \frac{I_C}{I_F} \times 100\%$$

RANK TABLE OF CURRENT TRANSFER RATIO CTR

MODEL NO.	RANK MARK	CTR (%)
LTV-214	0	20 ~ 400
	A	50 ~ 250
LTV-224 LTV-244	0	20~400

CONDITIONS	IF = ± 1 mA VCE = 5 V Ta = 25 °C
------------	--

CHARACTERISTICS CURVES

Figure 1. Collector Power Dissipation vs. Ambient Temperature

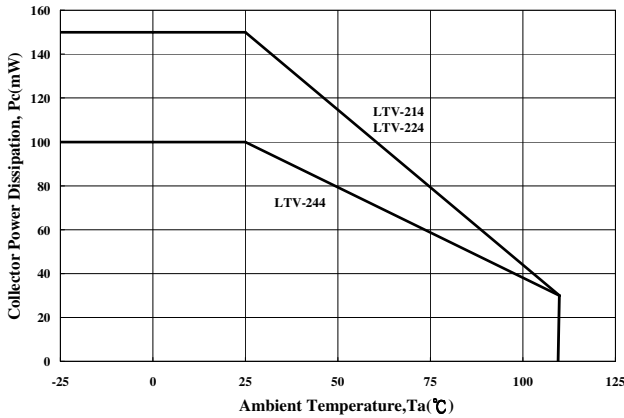

Figure 2. Forward Current vs. Ambient Temperature

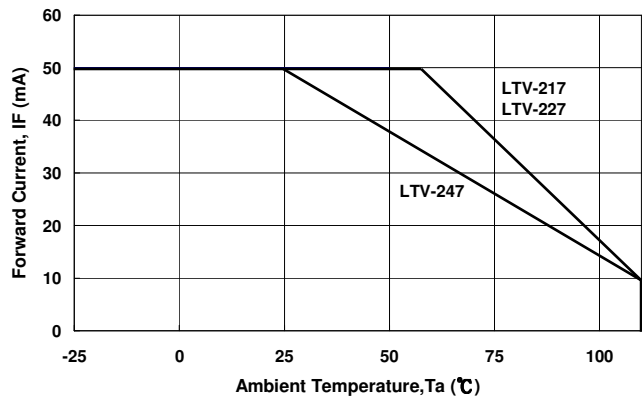

Figure 3. Forward Current vs. Forward Voltage

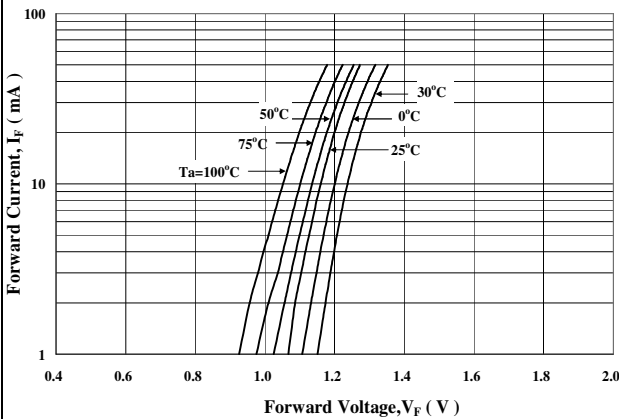

Figure 4. Forward Voltage Temperature Coefficient vs. Forward Current

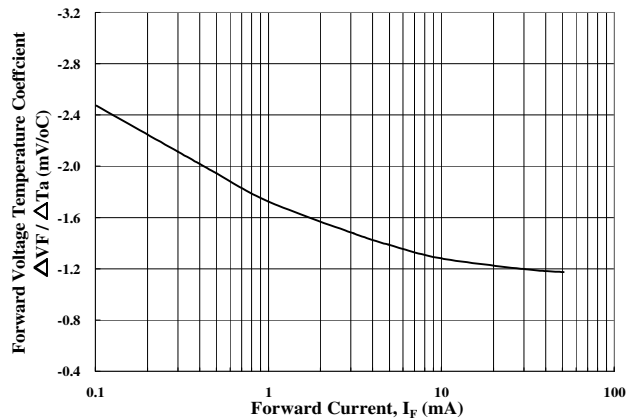

Figure 5. Pulse Forward Current vs. Duty Cycle Ratio

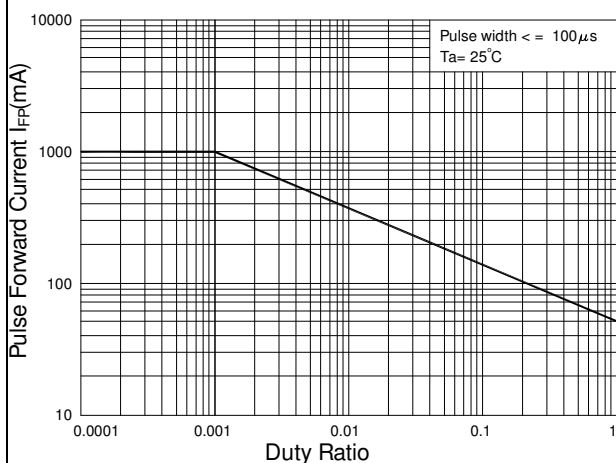
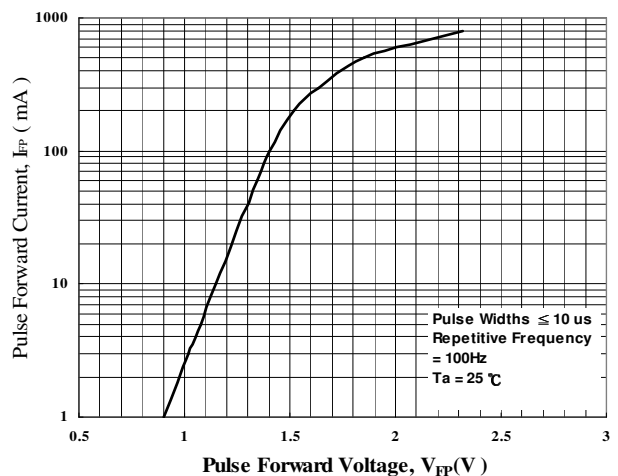

Figure 6. Pulse Forward Current vs. Pulse Forward Voltage



CHARACTERISTICS CURVES

Figure 7. Collector-Emitt Saturation Voltage vs. Forward Current

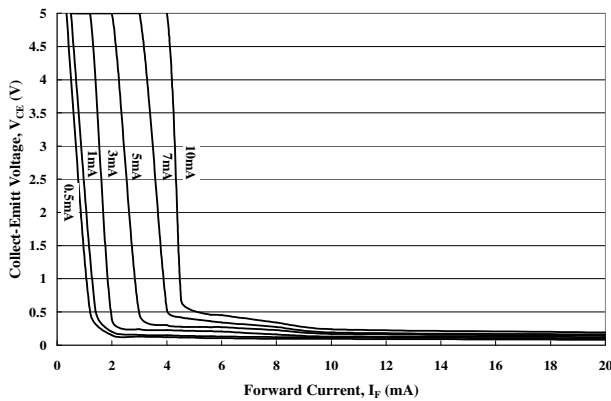

Figure 8. Collector Current vs. Collector-Emitt Voltage

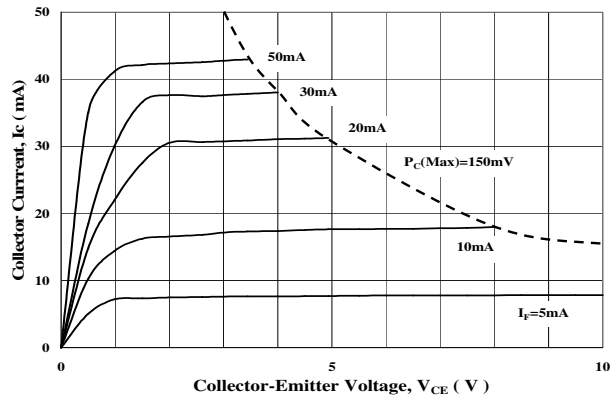

Figure 9. Collector Current vs. Small Collector-Emitt Voltage

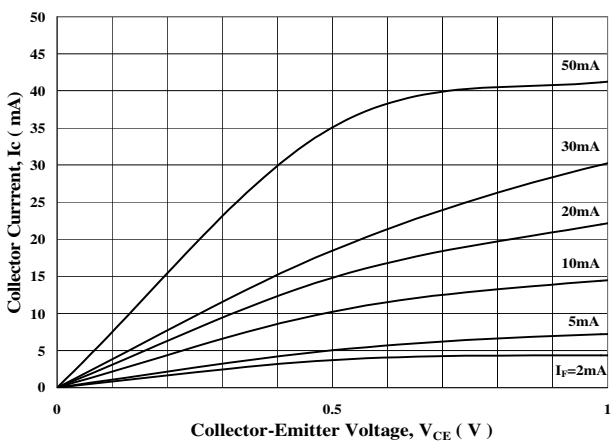

Figure 10. Collector Current vs. Forward Current

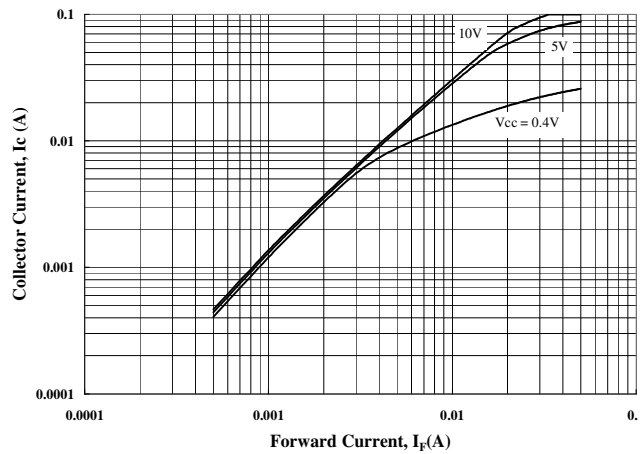

Figure 11. Collector Dark Current vs. Ambient Temperature

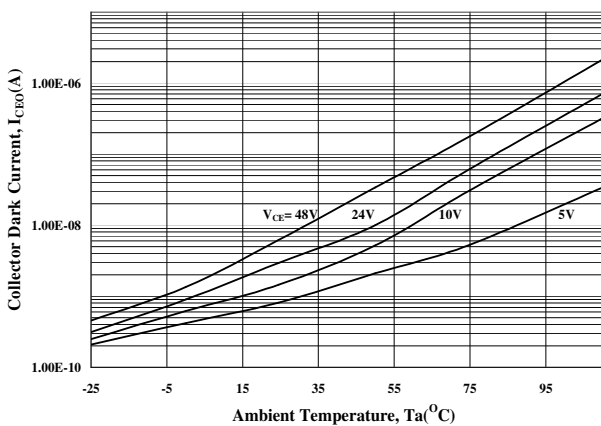
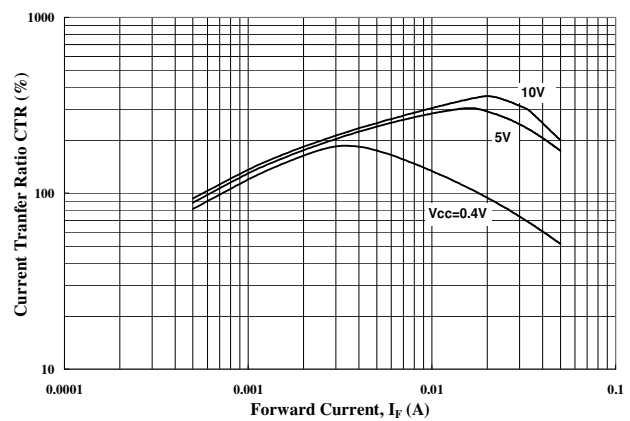

Figure 12. Current Transfer Ratio vs. Forward Current



CHARACTERISTICS CURVES

Figure 13. Collector-Emitter Saturation Voltage vs. Ambient Temperature

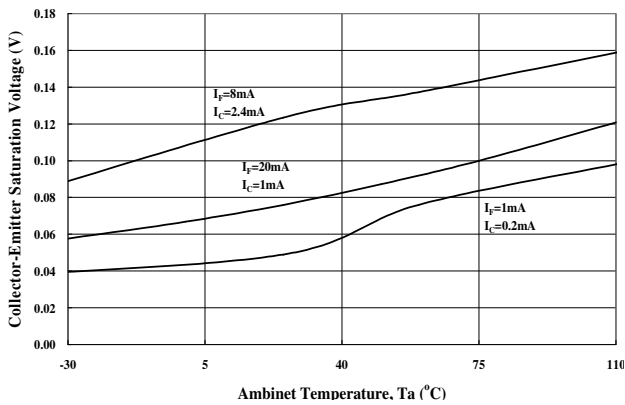

Figure 14. Collector Current vs. Ambient Temperature

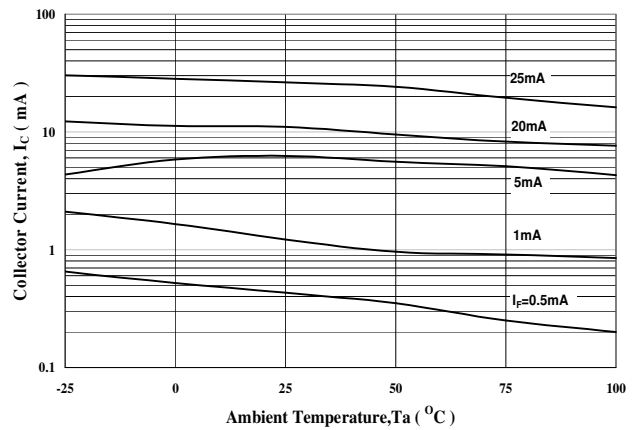

Figure 15. Switching Time vs. Load Resistance

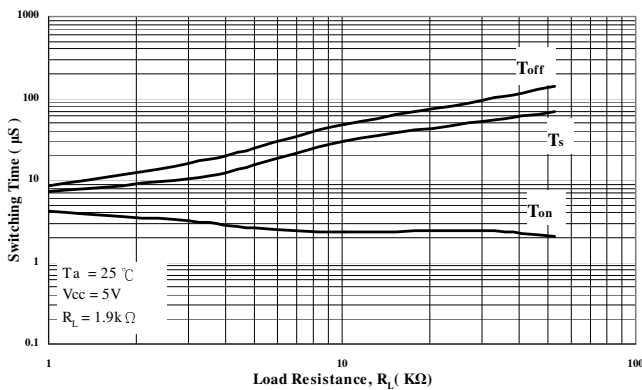

Figure 16. Switching Time vs. Ambient Temperature

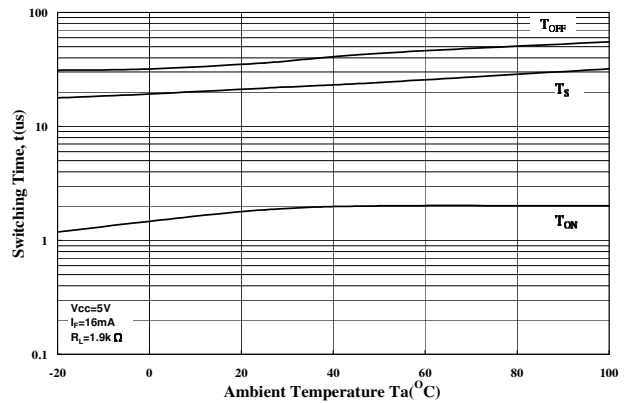
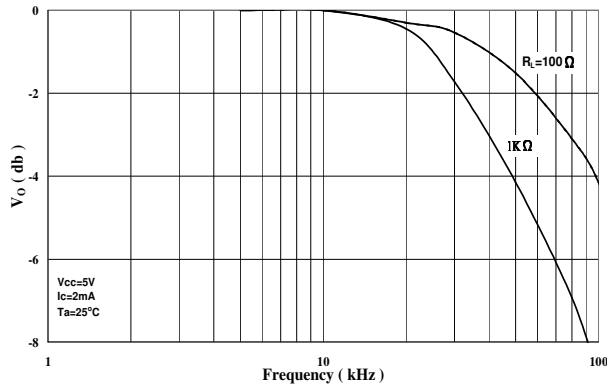
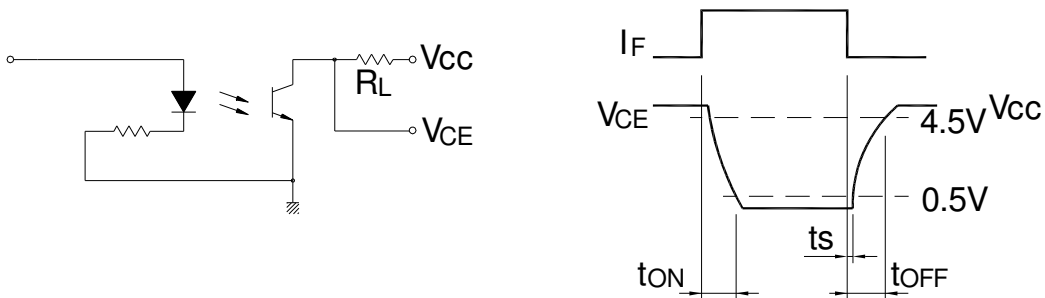

Figure 17. Frequency Response



SWITCHING TIME TEST CIRCUIT



TEMPERATURE PROFILE OF SOLDERING REFLOW

(1) One time soldering reflow is recommended within the condition of temperature and time profile shown below.

1. Wave solder
 - 260°C / 10 sec.

2. IR Reflow

Profile item	Conditions
Preheat	
- Temperature Min (T_{Smin})	150°C
- Temperature Max (T_{Smax})	180°C
- Time (min to max) (t_s)	90±30°C
Soldering zone	
- Temperature (T_L)	250°C
- Time (t_L)	10~15 sec
Peak Temperature (T_P)	260°C
Ramp-down rate	3~6°C / sec

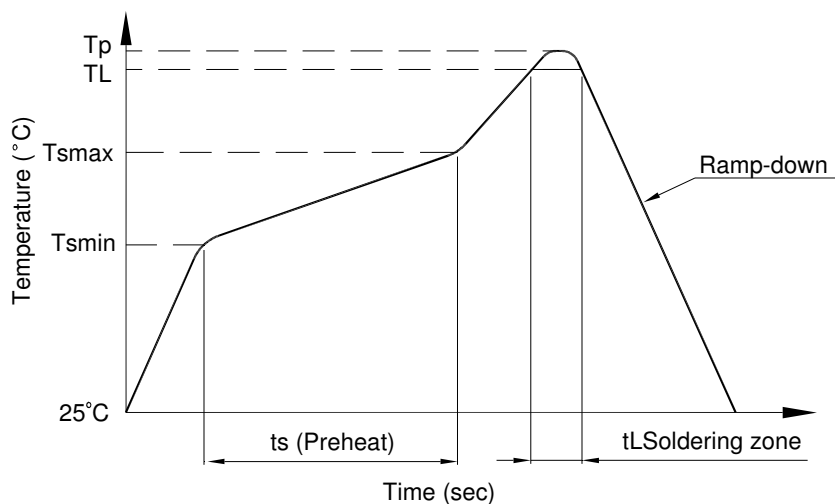

TEMPERATURE PROFILE OF SOLDERING REFLOW

(2) When using another soldering method such as infrared ray lamp, the temperature may rise partially in the mold of the device.

Keep the temperature on the package of the device within the condition of above (1)

RECOMMENDED FOOT PRINT PATTERNS (MOUNT PAD)

Unit:mm

LTV-214 series:

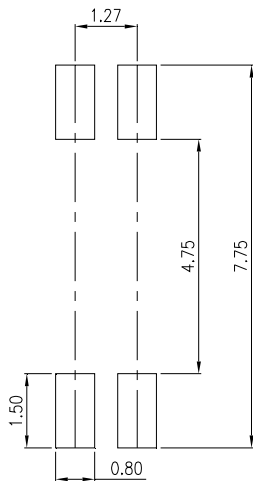

LTV-224 series:

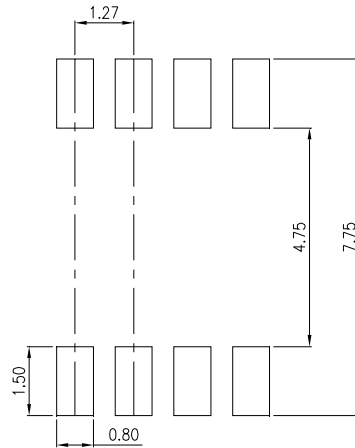

LTV-244 series:

