

LV885XXJA-GEVB

Evaluation Board for Motor Driver, Single-phase, PWM, Full-wave, BLDC Motor



ON Semiconductor®

www.onsemi.com

USER GUIDE

Overview

This evaluation board is designed to provide an easy and quick development platform for single-phase BLDC motor control applications, using the following devices.

- LV88551, LV88552, LV88553, LV88554
- LV88561, LV88562, LV88563, LV88564

These devices have the closed loop controller for motor rotation speed. And, potentiometers are provided on this board to configure the minimum/maximum target speed, the speed curve against the input PWM duty cycle, and some other parameters/options. The potentiometers might be useful for tuning these parameters and options, otherwise fixed resistors must be removed and re-soldered.

Setting with fixed resistors is also applicable by disconnecting the potentiometers.

Quick start

The evaluation board is programmed to work standalone without PC. The following operation allows the operation of most motors with the default parameters that are preloaded into the device.

- Step 1. Connect a motor to J3
- Step 2. Connect PWM signal to the pin labeled 'PWM'
- Step 3. Connect a power supply to J4 (J5 is provided optionally for low power application less than 4A).
- Step 4. Turn on power supply

Features

- LV88551JAGEVB LV88551RGEVB
- LV88552JAGEVB LV88552RGEVB
- LV88553JAGEVB LV88553RGEVB
- LV88554JAGEVB LV88554RGEVB
- LV88561JAGEVB LV88561RGEVB
- LV88562JAGEVB LV88562RGEVB
- LV88563JAGEVB LV88563RGEVB
- LV88564JAGEVB LV88564RGEVB

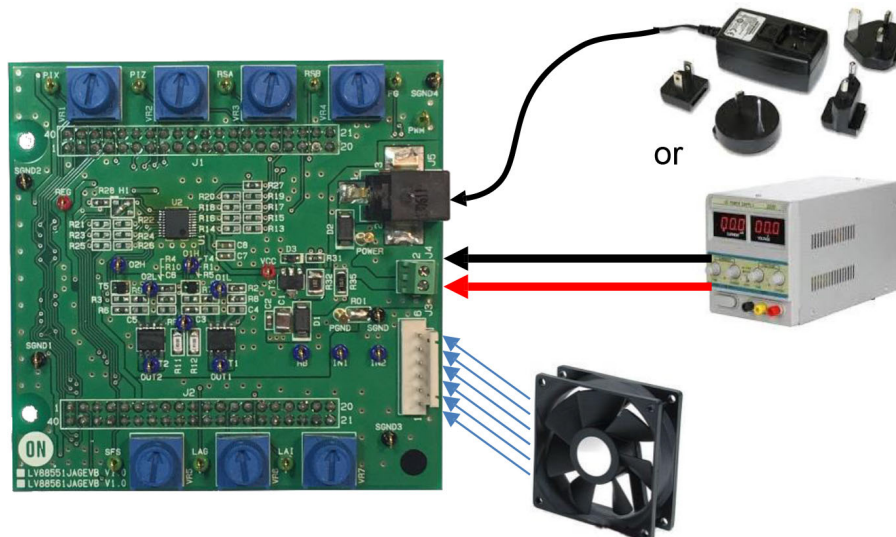

LV885XXJA-GEVB

HARDWARE DESCRIPTION

Table 1. NAME AND FUNCTION

1.	Evaluation board	The main board
2.	Connector J4	Main power connector
3.	Connector J5	Optional power jack
4.	Connector J3	Motor windings and signals related Hall
5.	Pin PWM	PWM input
6.	Pin FG	FG output
7.	IC U1 (or U2)	A dial to tweak the command PWM duty cycle for speed control
8.	FETs T1 and T2	Output power FET arrays

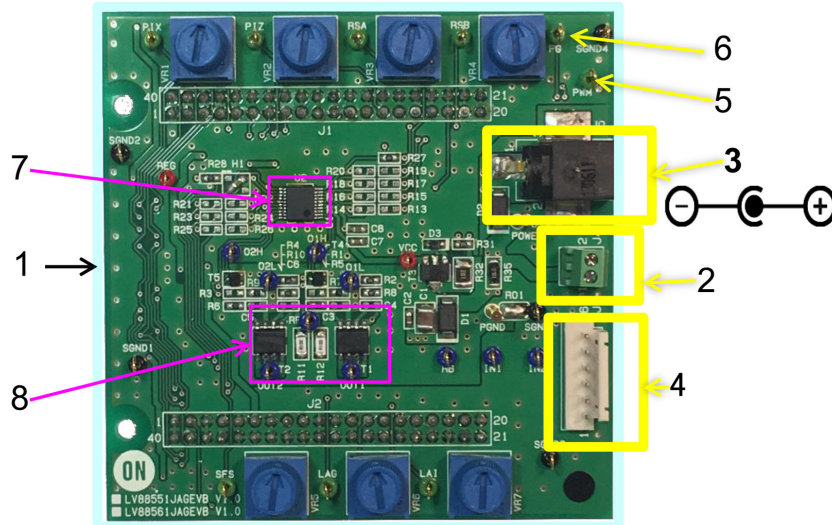

Figure 1. Connectors and key parts

Power Supply

J4 is the main power supply connector. The outputs of a power supplier will be connected to this connector. For LV885xEVB, the POWER pin voltage accepts up to 18 V. However, for LV885xEVB, POWER pin for the operation is from 24 V to 48 V.



Figure 2. Main power

J5 is an optional connector for a power supply. Low power is assumed (less than 4A).

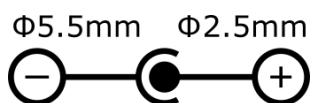

Figure 3. Power Connector Polarity

Motor

J3 is the motor connector.

Pin#	Silk label	Connected to
1	OUT2	Motor winding 2
2	OUT2	Motor winding 1
3	IN2	Hall signal +
4	IN1	Hall signal -
5	GND	Ground
6	HB	Hall bias

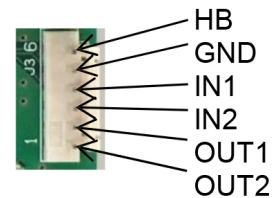

Figure 4. J3 Motor Connector

LV885XXJA-GEVB

Hall sensor or Hall IC

These devices need a Hall sensor or Hall IC to detect the commutation timing. IN1 and IN2 pins are Hall signal input pins. This EVB has Hall sensor and in this case, the resistor R38–R40 should be “OPEN”. However, in case of using Hall IC, they should be 10 kΩ.

This EVB can use for evaluation at stand-alone state. The AD converter parameters (assigned to the pins; RSA, RSB, PIX, PIZ, LAI, LAG, SFS), can be set by either analog potentiometers or register dividers. The following table shows resistor and jumper setting combination.

Parameter setting

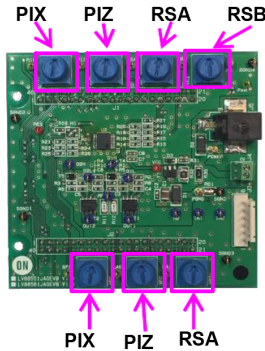

Table 2.

Parameter	Resistor and Jumper	Potentiometer	Fixed resistor divider	Digital potentiometer IC (Note 1)
PIX	R13	Open	Resistor	Open
	R14	Open	Resistor	Open
	RO2	Short	Open	Open
	RO4	Open	Open	Short
PIZ	R15	Open	Resistor	Open
	R16	Open	Resistor	Open
	RO5	Short	Open	Open
	RO7	Open	Open	Short
RSA	R17	Open	Resistor	Open
	R18	Open	Resistor	Open
	RO8	Short	Open	Open
	RO9	Open	Open	Short
RSB	R19	Open	Resistor	Open
	R20	Open	Resistor	Open
	RO10	Short	Open	Open
	RO12	Open	Open	Short
SFS	R21	Open	Resistor	Open
	R22	Open	Resistor	Open
	RO13	Short	Open	Open
	RO14	Open	Open	Short
LAG	R23	Open	Resistor	Open
	R24	Open	Resistor	Open
	RO15	Short	Open	Open
	RO17	Open	Open	Short

LV885XXJA-GEVB

Table 2.

Parameter	Resistor and Jumper	Potentiometer	Fixed resistor divider	Digital potentiometer IC (Note 1)
LAI	R25	Open	Resistor	Open
	R26	Open	Resistor	Open
	RO18	Short	Open	Open
	RO20	Open	Open	Short

1. Not supported in this version
2. RO3, RO6, RO11, RO16 and RO19 are for "ON INTERNAL USE", and are kept "Open".

TYPICAL OPERATION

Overall tuning procedure

1. Setup fan, power supply, pulse generator (for PWM duty cycle input)
2. Set setting pin voltage with either potentiometer or resistor pair
3. Turn-on power supply
4. Evaluate motor
5. Repeat from step 2, until appropriate evaluation result obtained

The configuration is loaded right after power-on from off. Therefore, power off/on cycle is required every time the parameters are changed.

Waveform example

Below is the example waveform of LV88561JA with various Lead Angle Settings.

The EVB condition is;

- VIN = 48 V
- 2000 RPM setting (PWM = 100%)

Lead Angle setting (LAG; 0 deg., LAI ; 0 deg.)

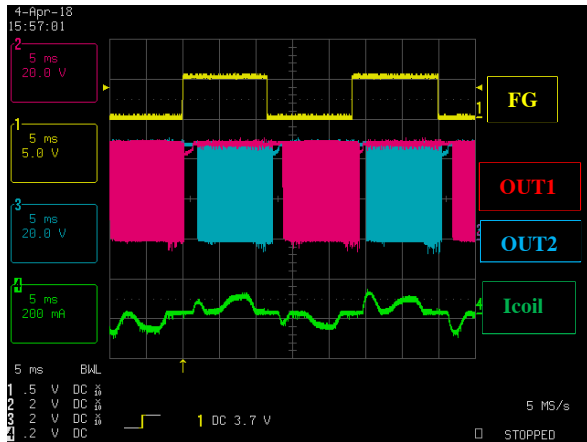

Lead Angle setting (LAG; +9.975 deg., LAI ; 0 deg.)

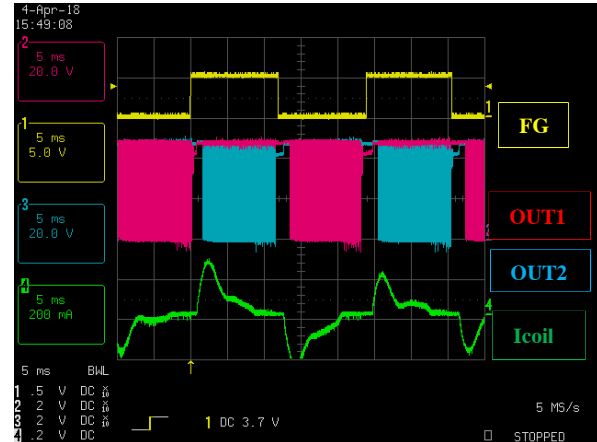

Lead Angle setting (LAG; -9.975 deg., LAI ; 0 deg.)

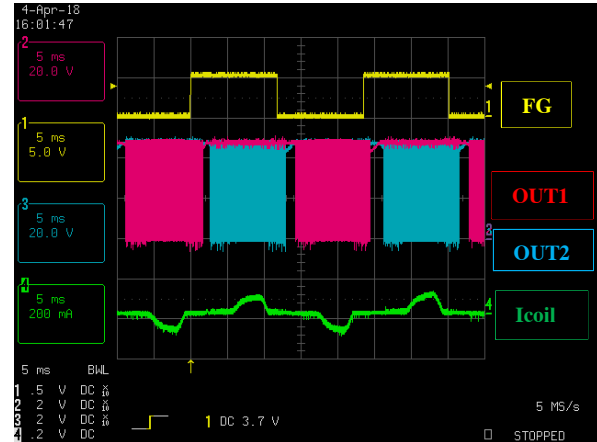

Figure 5. Demonstration Board Solution