

M12 Series Metal Barrel Sensors

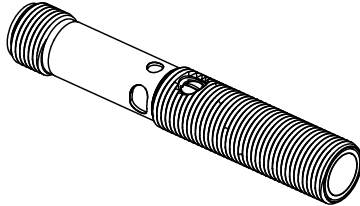

Datasheet

Rugged, self-contained sensors in a 12 mm threaded barrel



- Complete family of sensors, all housed in a compact 12 mm threaded metal barrel
- Opposed, retroreflective, polarized retroreflective, diffuse and 25, 50, or 75 mm cutoff fixed-field mode operation, depending on model
- Excellent background suppression on fixed-field models; an excellent alternative to proximity sensors
- Two signal indicator LEDs for easy operating status monitoring from any direction
- 10 V dc to 30 V dc operation
- Complementary solid-state outputs (one normally open, one normally closed); PNP or NPN, depending on model



WARNING:

- **Do not use this device for personnel protection**
- Using this device for personnel protection could result in serious injury or death.
- This device does not include the self-checking redundant circuitry necessary to allow its use in personnel safety applications. A device failure or malfunction can cause either an energized (on) or de-energized (off) output condition.

Models

Models ¹	Sensing Mode	Sensing Beam	Range	Output
M12E	 OPPOSED ²	660 nm Visible Red	5 m (16.4 ft)	N/A
M12PR				PNP
M12NR				NPN
M12PLP	 POLAR RETRO	660 nm Visible Red	1.5 m (4.9 ft) ³	PNP
M12NLP				NPN
M12PLV	 RETRO	660 nm Visible Red	2.5 m (8.2 ft) ³	PNP
M12NLV				NPN
M12PD	 DIVERGENT DIFFUSE ⁴	660 nm Visible Red	400 mm (15.7 in)	PNP
M12ND				NPN
M12PFF25	 FIXED-FIELD ⁴	680 nm Visible Red	25 mm (1 in) cutoff; 25 mm (1 in) focus 50 mm (2 in) cutoff; 25 mm (1 in) focus 75 mm (3 in) cutoff; 25 mm (1 in) focus	PNP
M12NFF25				NPN
M12PFF50				PNP
M12NFF50				NPN
M12PFF75				PNP
M12NFF75				NPN

¹ Only standard 2 m (6.5 ft) cable models are listed. For 9 m (30 ft) cable, add suffix "W/30" to the model number (for example, M12E W/30). Quick-disconnect models:

- 4-pin integral Euro-style M12 connector: add suffix "Q8" (for example, M12EQ8)
- 4-pin 150 mm (6 in) Euro-style connector: add suffix "Q5" (for example, M12EQ5)

² Effective Beam: 10 mm (0.39 in)

³ Retroreflective range is specified using one model BRT-84 retroreflector. Actual sensing range may be more or less than specified, depending upon efficiency and reflective area of the retroreflector(s) used.

⁴ Performance based on use of 90% reflectance white test card.



Overview

Banner's M12 family of sensors offers a full complement of sensing modes, all packaged in a compact yet rugged metal housing. The 12 mm barrel design allows them to mount easily into tight spaces, with the excellent performance expected of much larger sensors.

The single-turn Gain potentiometer on most models and two Signal LEDs (positioned on either side of the housing for visibility) provide easy alignment and configuration for reliable sensing (see [Figure 1](#) on page 2). Note that when the signal LED is not ON, the green Power LED is visible through all three LED ports.

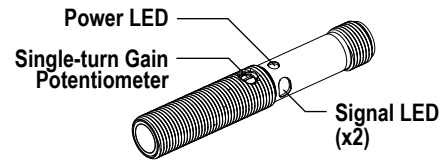

Figure 1. Features

LED Status	Description
Green ON Steady	Power ON
Green Flashing	Output overloaded
Amber ON Steady	Light Sensed
Amber Flashing	Marginal excess gain

Fixed-Field Mode Overview

M12 Series fixed-field sensors are powerful diffuse-mode sensors with far-limit cutoff (a type of background suppression). Their high excess gain and fixed-field technology allow them to detect objects of low reflectivity that are directly in front of another surface, while ignoring the surface in the background.

The cutoff distance is fixed. Background and background objects must *always* be placed beyond the cutoff distance.

As a general rule, the most reliable sensing of an object approaching from the side occurs when the line of approach is parallel to the sensing axis.

Fixed-Field Sensing – Theory of Operation

The M12FF compares the reflections of its emitted light beam (E) from an object back to the sensor's two differently aimed detectors, R1 and R2. See [Figure 2](#) on page 2. If the near detector's (R1) light signal is stronger than the far detector's (R2) light signal (see object A in the Figure below, closer than the cutoff distance), the sensor responds to the object. If the far detector's (R2) light signal is stronger than the near detector's (R1) light signal (see object B in the Figure below, beyond the cutoff distance), the sensor ignores the object.

The cutoff distance for the model M12FF sensors is fixed at 25, 50, or 75 mm (1 in, 2 in, or 3 in). Objects lying beyond the cutoff distance are usually ignored, even if they are highly reflective. However, under certain conditions, it is possible to falsely detect a background object (see [Background Reflectivity and Placement](#) on page 3).

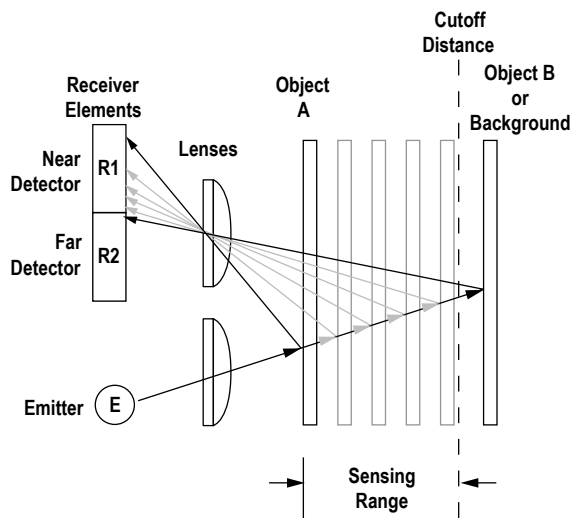

Object is sensed if amount of light at R1 is greater than the amount of light at R2

Figure 2. Fixed-Field Concept

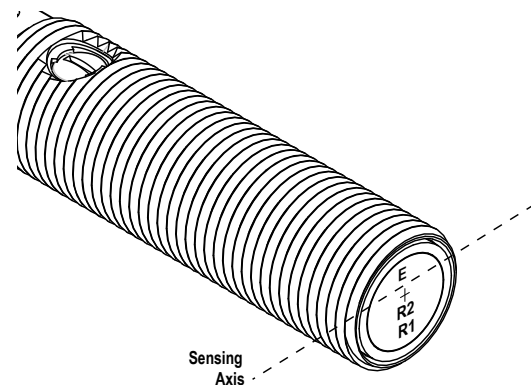

Figure 3. Fixed-Field Sensing Axis

In the drawings and information provided in this document, the letters E, R1, and R2 identify how the sensor's three optical elements (Emitter "E", Near Detector "R1", and Far Detector "R2") line up across the face of the sensor. The location of these elements defines the sensing axis, see [Figure 3](#) on page 2. The sensing axis becomes important in certain situations, such as those illustrated in [Figure 6](#) on page 3 and [Figure 7](#) on page 3.

Configuration Instructions

Sensing Reliability

For highest sensitivity, position the target for sensing at or near the point of maximum excess gain. See Performance Curves section for the excess gain curves. Sensing at or near this distance makes the maximum use of each sensor's available sensing power. The background must be placed beyond the cutoff distance. Note that the reflectivity of the background surface also may affect the cutoff distance. Following these guidelines improves sensing reliability.

Background Reflectivity and Placement

Avoid mirror-like backgrounds that produce specular reflections. A false sensor response occurs if a background surface reflects the sensor's light more to the near detector (R1) than to the far detector (R2). The result is a false ON condition (Figure 4 on page 3). Correct this problem by using a diffusely reflective (matte) background, or angling either the sensor or the background (in any plane) so the background does not reflect light back to the sensor (Figure 5 on page 3). Position the background as far beyond the cutoff distance as possible.

An object beyond the cutoff distance, either stationary (and when positioned as shown in Figure 6 on page 3), or moving past the face of the sensor in a direction perpendicular to the sensing axis, may cause unwanted triggering of the sensor if more light is reflected to the near detector than to the far detector. Correct the problem by rotating the sensor 90° (Figure 7 on page 3). The object then reflects the R1 and R2 fields equally, resulting in no false triggering. A better solution, if possible, may be to reposition the object or the sensor.

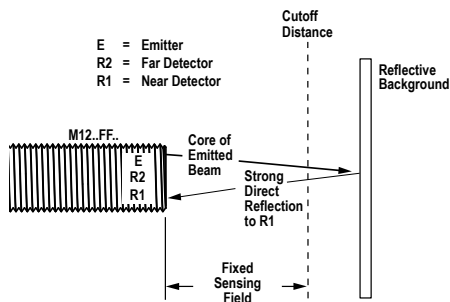

Figure 4. Reflective Background - Problem

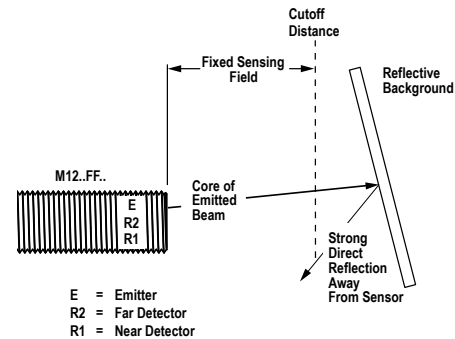
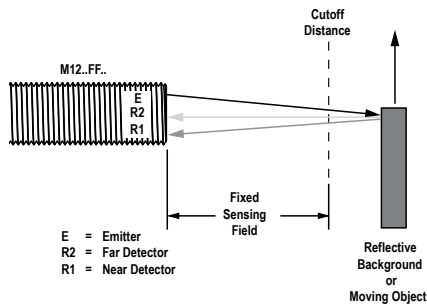
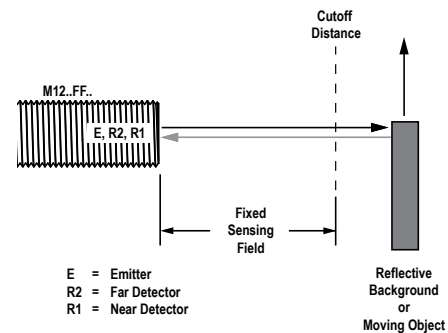

Figure 5. Reflective Background - Solution



A reflective background object in this position or moving across the sensor face in this axis and direction may cause a false sensor response.

Figure 6. Object Beyond Cutoff - Problem



A reflective background object in this position or moving across the sensor face in this axis is ignored.

Figure 7. Object Beyond Cutoff - Solution

Color Sensitivity

The effects of object reflectivity on cutoff distance, though small, may be important for some applications. It is expected that at any given cutoff setting, the actual cutoff distance for lower reflectance targets is slightly shorter than for higher reflectance targets. This behavior is known as color sensitivity.

These excess gain curves were generated using a white test card of 90% reflectance. Objects with reflectivity of less than 90% reflect less light back to the sensor, and thus require proportionately more excess gain in order to be sensed with the same reliability as more reflective objects. When sensing an object of very low reflectivity, it may be especially important to sense it at or near the distance of maximum excess gain.

Wiring Diagrams

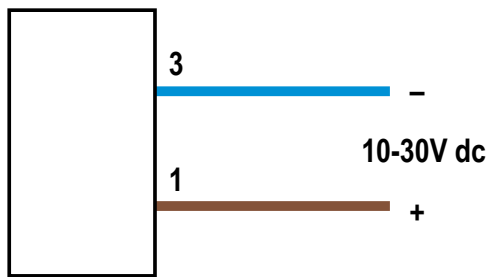

Figure 8. Emitter

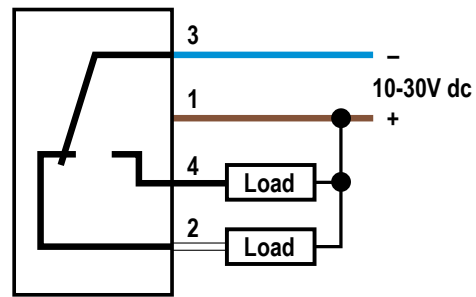

Figure 9. NPN Models

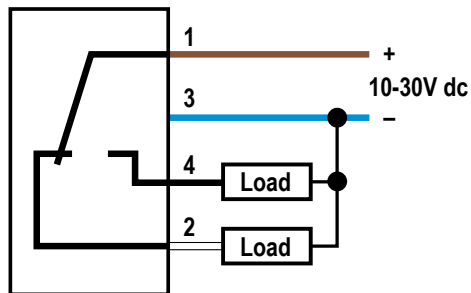

Figure 10. PNP Models

Key

- 1 = Brown
- 2 = White
- 3 = Blue
- 4 = Black

Quick disconnect wiring diagrams are functionally identical.

Installation Instructions

Mount the Device

1. If a bracket is needed, mount the device onto the bracket.
2. Mount the device (or the device and the bracket) to the machine or equipment at the desired location. Do not tighten the mounting screws at this time.
3. Check the device alignment.
4. Tighten the mounting screws to secure the device (or the device and the bracket) in the aligned position.

Specifications

Sensing Beam

Fixed Field Models: Visible red, 680 nm
All Other Models: Visible red, 660 nm

Supply Voltage and Current

10 V dc to 30 V dc (10% max. ripple) at 20 mA current, exclusive of load

Supply Protection Circuitry

Protected against reverse polarity and transient voltages

Output Configuration

Complementary (one normally open and one normally closed) solid-state, NPN, or PNP, depending on model

Output Ratings

100 mA total across both outputs with overload and short circuit protection

OFF-state leakage current:

- NPN: less than 200 μ A at 30 V dc (see Application Note)
- PNP: less than 10 μ A at 30 V dc

ON-state saturation voltage:

- NPN: less than 1.6 V at 100 mA
- PNP: less than 3.0 V at 100 mA

Output Protection Circuitry

Protected against output short-circuit and false pulse on power up

Output Response Time

Opposed Mode: 625 μ s ON/375 μ s OFF
All Other Modes: 500 μ s ON and OFF



Note: 100 ms delay on power-up; outputs do not conduct during this time.

Repeatability

Opposed Mode: 85 μ s
All Other Modes: 95 μ s

Indicators

Two Status (amber) and one Power (green) LED (see Figure 1 on page 2)

Adjustments

Fixed-Field Models: None
All Other Models: Single-turn Gain (sensitivity) potentiometer

Construction

Housing: Nickel-plated brass
Lenses: PMMA
Cable Endcap and Gain Potentiometer Adjuster: PBT

Environmental Rating

IEC IP67; NEMA 6, IEC IP68, and 1200 PSI washdown, NEMA ICS 5 Annex F-2002

Connections

2 m (6.5 ft) or 9 m (30 ft) 4-wire PVC-jacketed cable, Integral 4-pin M12/Euro-style quick disconnect fitting, or 4-pin 150 mm (6 in) M12/Euro-style fitting, depending on model

Operating Conditions

Operating Temperature: -20 °C to +60 °C (-4 °F to +140 °F)
90% at +50 °C maximum relative humidity (non-condensing)

Application Notes

NPN off-state leakage current is < 200 μ A for load resistances > 3 k Ω or optically isolated loads. For load current 100 mA, leakage is <1% of load current.

Certifications

Dimensions

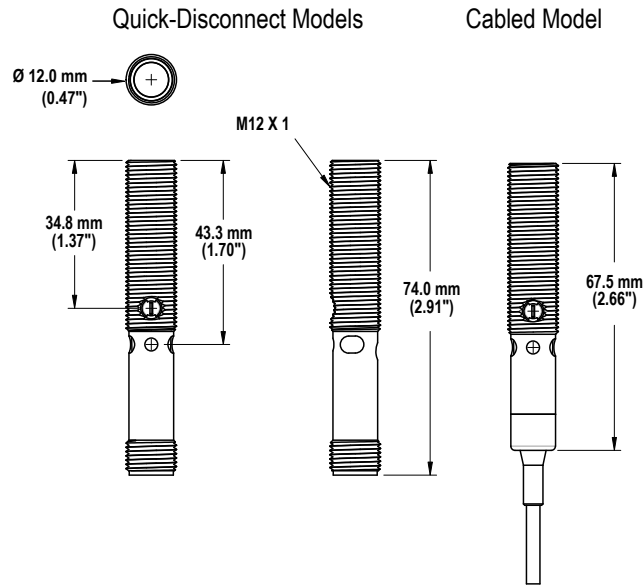

Performance Curves

Excess Gain

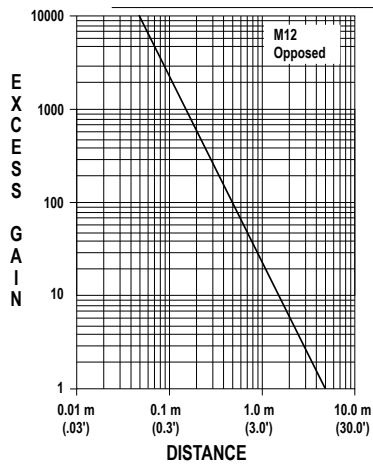

Figure 11. Opposed

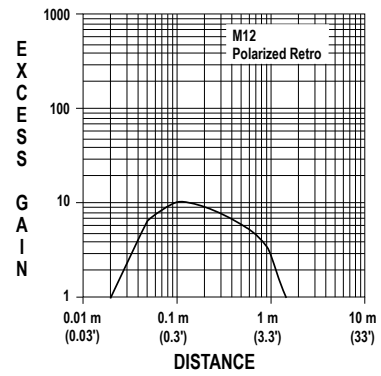

Figure 12. Polarized Retro[§]

[§] Performance based on use of a model BRT-84 retroreflector.

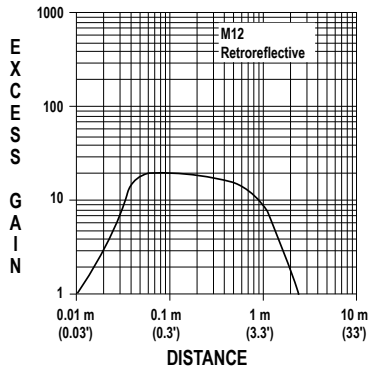

Figure 13. Retro[®]

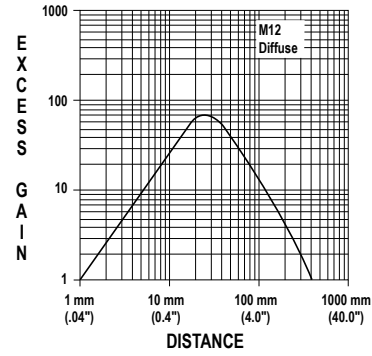

Figure 14. Diffuse[®]

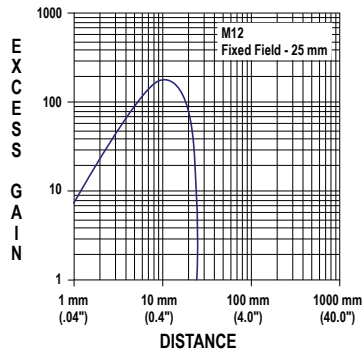

Figure 15. Fixed-Field - 25 mm

Ø 2 mm spot size at 25 mm focus
 Ø 2 mm spot size at 25 mm focus
 Focus and spot sizes are typical
 Performance based on use of 90% reflectance white test card
 Using 18% gray test card: cutoff distance will be 96% of value shown
 Using 6% black test card: cutoff distance will be 94% of value shown

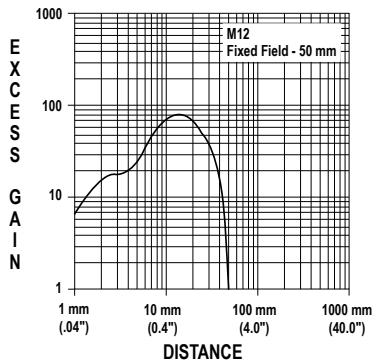

Figure 16. Fixed-Field - 50 mm

Ø 2 mm spot size at 25 mm focus
 Ø 7 mm spot size at 50 mm focus
 Focus and spot sizes are typical
 Performance based on use of 90% reflectance white test card
 Using 18% gray test card: cutoff distance will be 90% of value shown
 Using 6% black test card: cutoff distance will be 85% of value shown

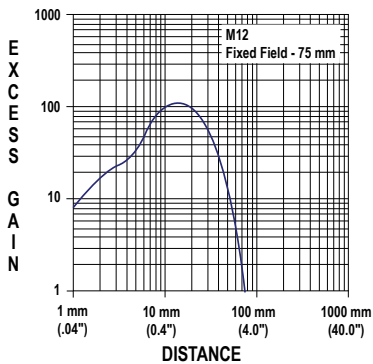

Figure 17. Fixed-Field - 75 mm

Ø 2 mm spot size at 25 mm focus
 Ø 13 mm spot size at 75 mm focus
 Focus and spot sizes are typical
 Performance based on use of 90% reflectance white test card
 Using 18% gray test card: cutoff distance will be 80% of value shown
 Using 6% black test card: cutoff distance will be 70% of value shown

[®] Performance based on use of 90% reflectance white test card.

Beam Pattern

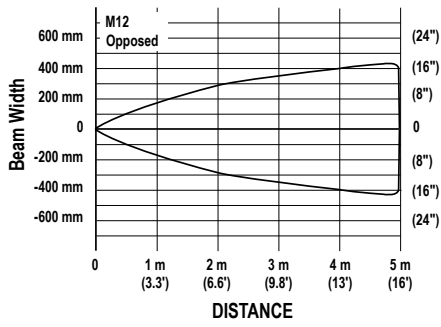

Figure 18. Opposed

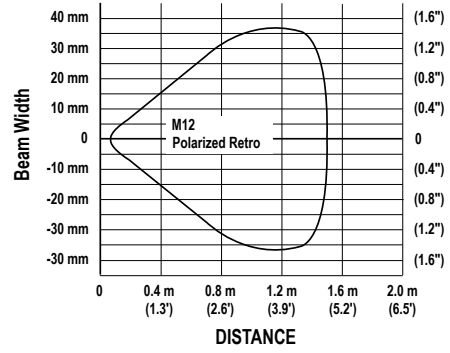

Figure 19. Polarized Retro

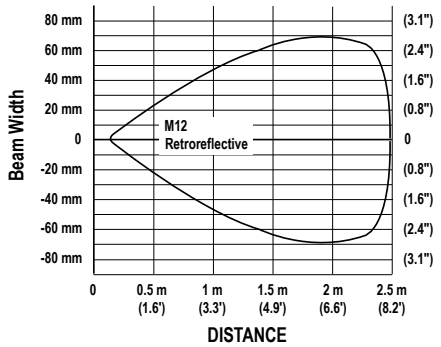

Figure 20. Retro

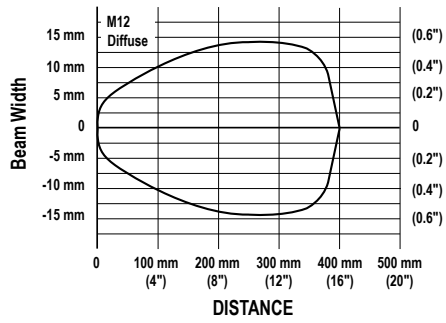

Figure 21. Diffused

Accessories

Cordsets

4-Pin Threaded M12/Euro-Style Cordsets—Single Ended				
Model	Length	Style	Dimensions	Pinout (Female)
MQDC-406	2 m (6.5 ft)	Straight		<p>1 = Brown 2 = White 3 = Blue 4 = Black</p>
MQDC-415	5 m (15 ft)			
MQDC-430	9 m (30 ft)			
MQDC-406RA	2 m (6.5 ft)	Right-Angle		
MQDC-415RA	5 m (15 ft)			
MQDC-430RA	9 m (30 ft)			

Performance based on use of a model BRT-84 retroreflector.