

T-GAGE™ M18T Series Infrared Temperature Sensors



Datasheet

18 mm Sensor with 0 to 10 V and 4 to 20 mA Analog Output and TEACH Configuration

To view or download the latest technical information about this product, including specifications, dimensions, accessories, and wiring, go to www.bannerengineering.com.

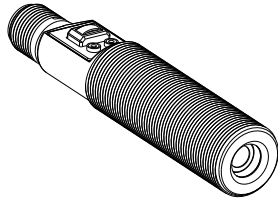

- Fast 75 ms response time
- Easy-to-use TEACH configuration without potentiometer adjustments
- Small, self-contained package; no auxiliary controller needed
- Rugged encapsulated design for harsh environments
- Choice of 2 meter or 9 meter unterminated cable, or 5-pin M12 quick disconnect
- Product motion not required for sensing
- Remote configuration available in both Static and Dynamic modes
- Alarm output for signal maximum
- Configuration for either positive or negative analog slope based on teach order



WARNING:

- **Do not use this device for personnel protection**
- Using this device for personnel protection could result in serious injury or death.
- This device does not include the self-checking redundant circuitry necessary to allow its use in personnel safety applications. A device failure or malfunction can cause either an energized (on) or de-energized (off) output condition.



WARNING:

- **N'utilisez pas ce dispositif pour la protection du personnel.**
- L'utilisation de ce dispositif pour la protection du personnel pourrait entraîner des blessures graves ou mortelles.
- Ce dispositif n'est pas équipé du circuit redondant d'autodiagnostic nécessaire pour être utilisé dans des applications de protection du personnel. Une panne ou un dysfonctionnement du dispositif peut entraîner l'activation ou la désactivation de la sortie.

Models

Model	Cable ¹	D:S Ratio	Sensing Face	Supply Voltage	Output
M18TUP8	5-wire, 2 m (6.5 ft) shielded cable	8:1	Integrated lens	12 V DC to 30 V DC	0 V DC to 10 V DC analog, plus PNP Alarm
M18TUP8Q	5-pin M12 integral QD				
M18TUP6E	5-wire, 2 m (6.5 ft) shielded cable	6:1	Enclosed Plastic face (for food industry use)		
M18TUP6EQ	5-pin M12 integral QD				
M18TUP14	5-wire, 2 m (6.5 ft) shielded cable	14:1	Germanium lens		
M18TUP14Q	5-pin M12 integral QD	8:1	Integrated lens		4 to 20 mA analog, plus PNP Alarm
M18TIP8	5-wire, 2 m (6.5 ft) shielded cable				
M18TIP8Q	5-pin M12 integral QD	6:1	Enclosed Plastic face (for food industry use)		
M18TIP6E	5-wire, 2 m (6.5 ft) shielded cable				
M18TIP6EQ	5-pin M12 integral QD	14:1	Germanium lens		
M18TIP14	5-wire, 2 m (6.5 ft) shielded cable				
M18TIP14Q	5-pin M12 integral QD				

Overview

The T-GAGE analog sensor is a passive, non-contacting, temperature-based device. It is used to detect object temperature within a sensing window and output a proportional voltage or current.

Although it looks and operates just like an Expert™ photoelectric sensor, the T-GAGE detects the infrared light energy emitted by objects instead of its own emitted light. The sensor uses a thermopile detector, made up of multiple infrared-sensitive elements (thermocouples) to detect this infrared energy within its field of view (see [Sensing Field of View](#) on p. 2).

¹ To order the 9 m (30 ft) PVC cable model, add the suffix "W/30" to the cabled model number. For example, **M18TUP8 W/30**. Models with a quick disconnect require a mating cordset. See [Cordsets](#) on p. 7 for more information.



Potential applications include:

- Hot part detection (baked goods, metals, bottles, rubber)
- Ejection verification of injection-molded parts
- Flame process verification
- Hot glue detection (packaging equipment, book binding)
- Cold part detection (frozen foods, ice, dairy)
- Roller monitoring

Figure 1. Sensor Features

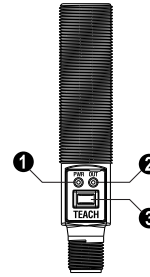

1. Power LED
2. Alarm Output LED
3. Push Button



Note: The T-GAGE M18T sensor is not intended for absolute temperature measurement or for safety-related fire detection use.



Note: Le T-GAGE M18T n'est pas conçu pour une mesure de température absolue ni pour une utilisation dans le cadre de sécurité pour la détection de feu.

Indicators

Power ON/OFF LED	Indicates	Alarm Output LED	Indicates
OFF	Power is OFF	OFF	Run Mode: Alarm output is OFF 2-Point TEACH active: Waiting for Span condition
ON Green	Sensor is in Run mode	ON Amber	Run Mode: Alarm output is energized 2-Point TEACH active: Waiting for Null condition
ON Red	TEACH is active	Flashing Amber	Dynamic TEACH active

Sensing Field of View

Sensing range is determined by the sensor's field of view or viewing angle, combined with the size of the object(s) being detected. The sensor's distance-to-spot size ratio (D:S ratio) is inversely related to the viewing angle; a sensor with a small viewing angle will have a large D:S ratio. The T-GAGE M18T sensors have D:S ratios of 6:1, 8:1 or 14:1. For a sensor with an 8:1 D:S ratio, the sensor spot size is a 1" diameter circle at a distance of 8"; farther from the sensor face the spot size will be larger.

Figure 2. Detection spot size versus distance from sensor

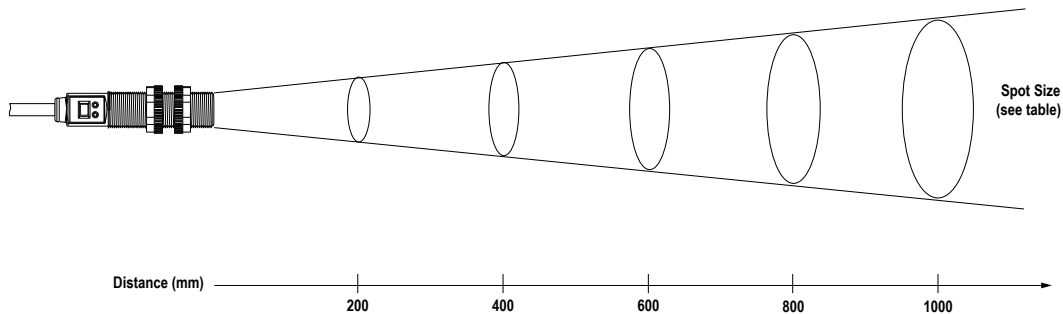

Sensor D:S Ratio	Distance from Sensor Face Versus Spot Size										
	100	200	300	400	500	600	700	800	900	1000	Distance (mm)
6:1	17	33	50	67	83	100	117	133	150	167	Spot Size (mm)
8:1	13	25	38	50	63	75	88	100	113	125	
14:1	7	14	21	29	36	43	50	57	64	71	

Apparent Temperature

Two factors that have a large influence on apparent temperature are the object's emissivity and whether or not the object fills the sensor field of view.

Object Emissivity

A "blackbody" is a "perfect" emitter, with an emissivity of 1.0 at all temperatures and wavelengths. Most surfaces emit only a fraction of the amount of thermal energy that a blackbody would. Typical T-GAGE applications will be sensing objects with emissivities ranging from 0.5 to 0.95. Many references are available with tables of emissivity coefficients for common materials. In general, shiny unpainted metals have low emissivity, while non-glossy surfaces have high emissivity.

Shiny Surfaces

A mirror or shiny surface can redirect an object's emitted energy to an undesired location, or even bring additional unintended thermal energy into the sensor's field of view. See [Application Note](#) on p. 6.

Object Size

If the object being detected does not fill the sensor field of view, then the sensor averages the temperature of that object and whatever else is in the sensing field of view. For the sensor to collect the maximum amount of energy, the object should completely fill the sensor field of view. In some applications, when the object is too small, this may not be possible. In such cases, if the object is hot enough, the thermal contrast may still be adequate to trigger the sensor output.

Alarm Output

The alarm output will activate when the analog output is at 10V or 20mA, depending on model (see [Figure 3](#) on p. 3).

Analog Output

The T-GAGE analog sensor can be programmed for either positive or negative output slope, based on the teach order (see [Figure 3](#) on p. 3). If the cold limit is taught first, the slope will be positive; if the hot limit is taught first, the slope will be negative. Banner’s scalable output automatically distributes the output signal over the width of the programmed sensing window.

Figure 3. Analog/Alarm outputs as a function of taught conditions

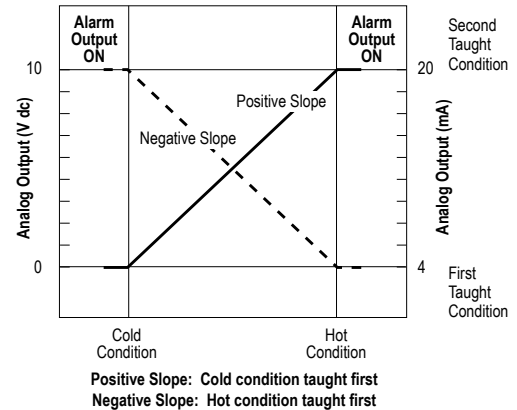

Installation

Installation Note

Align the sensor toward the object to be detected. Visually align if possible, or use the alignment device accessory listed in [Additional Accessories](#) on p. 7.

Wiring Diagram

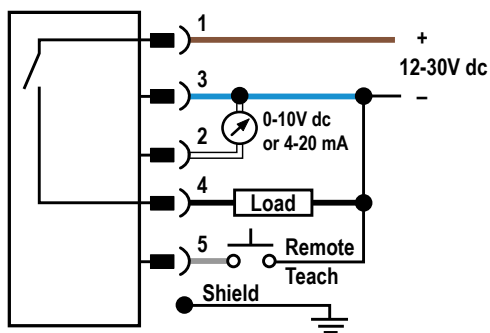

Note: Cabled wiring diagrams are functionally identical.



Note: Connect the shield wire to earth ground or dc common. Shielded cordsets are recommended for all quick disconnect models.

Sensor Configuration

Configure the sensor using one of two TEACH methods:

- Two-Point Static TEACH
- Dynamic TEACH

Use the push button or remote input to configure the sensor.



Note: The duration of each remote line pulse (corresponding to a push button “click”), and the period between multiple pulses, are defined as “T”: 0.04 seconds < T < 0.8 seconds.

Push Button Enable/Disable

The push button can be disabled using the remote input wire (gray) to prevent unauthorized adjustment. To disable the push button, connect a normally open switch between the remote input wire and dc common or connect the remote input wire to a digital output on a Programmable Logic Controller (PLC). Perform the procedure below to enable or disable the push button, where 0.04 s < T < 0.8 s.

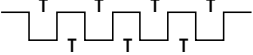
Method	Action	Result
Remote Input	Pulse the remote line four times.	 The push button is enabled or disabled, depending on the previous condition.

2-Point Static TEACH

Use 2-Point Static TEACH configuration method for applications where both ON and OFF target conditions can be presented to the sensor statically by the operator. The sensor establishes the Null (0 V or 4 mA) output condition with the first configured condition and the Span (10V or 20mA) output condition with the second configured condition, and it scales between these points.



Note: The sensor returns to RUN mode if the first 2-Point Static TEACH condition is not configured within 60 seconds.



Note: After the first condition is configured, the sensor remains in 2-Point Static TEACH configuration until the second condition is configured.

1. Access 2-Point Static TEACH configuration.

Method	Action	Result
Push Button	Press and hold the button for 2 seconds.	 <ul style="list-style-type: none"> • Power LED turns Red • Alarm LED turns ON
Remote Input (0.04 s < T < 0.8 s)	No action required.	

2. Present the condition for Null output.

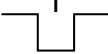
Method	Action	Result
Push Button	Press the button one time.	 <ul style="list-style-type: none"> • Alarm LED turns OFF
Remote Input	Pulse the remote line one time.	

3. Present the condition for Span output.

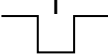
Method	Action	Result
Push Button	Press the button one time.	 TEACH Accepted <ul style="list-style-type: none"> • Power LED turns Green • The sensor configures analog range and returns to Run mode
Remote Input	Pulse the remote line one time.	 2-Point Static TEACH Not Accepted The sensor returns to the beginning of the TEACH configuration.



Note: To exit 2-Point Static TEACH configuration without saving a configuration, press and hold the push button for 2 seconds or hold the remote line for 2 seconds. The sensor will return to Run mode without saving a configuration.

Dynamic TEACH

Use Dynamic TEACH configuration method for applications where both the ON and OFF target conditions can not be presented to the sensor dynamically by the operator. After the configuration has been completed, the analog range is optimized by the sensor halfway between the average signals presented during the Dynamic TEACH configuration.

The output slope will remain in the direction of the most recently taught Two-Point Static TEACH or default to positive.

1. Access Dynamic TEACH configuration.

Method	Action	Result
Push Button	Press and hold the button for 2 seconds.	 <ul style="list-style-type: none"> • Power LED turns Red • Alarm LED turns OFF
Remote Input (0.04 s < T < 0.8 s)	No action required.	

2. Present the sensing conditions.

Method	Action	Result
Push Button	Press the button two times.	 <ul style="list-style-type: none"> • Sensor begins Dynamic TEACH configuration • Alarm LED flashes Amber at 2 Hz

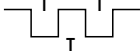
Method	Action	Result
Remote Input	Pulse the remote line two times.	

3. End Dynamic TEACH configuration.

Method	Action	Result
Push Button	Press the button one time.	<ul style="list-style-type: none"> The sensor ends data collection; configures Null and Span limits Power LED turns Green The sensor returns to Run mode
Remote Input	Pulse the remote line one time.	

Changing Direction of Output Slope

The following procedure changes the direction of the analog output slope from negative to positive or from positive to negative. See [Analog Output](#) on p. 3 for an explanation of the analog output slope.

Change the output slope direction.

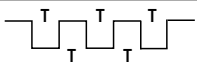
Method	Action	Result
Push Button	Not available via the push button.	
Remote Input ²	Three-pulse the remote line.	

Specifications

Temperature Measurement Range

-20 °C to +300 °C (-4 °F to +572 °F) ³
 Custom ranges available upon request

Sensing Range

Depends on object size and sensing field of view (see [Sensing Field of View](#) on p. 2)

Wavelength

8 μm to 14 μm

Distance to Spot Size (D:S) Ratio

6:1, 8:1, or 14:1, depending on model

Supply Voltage

12 V DC to 30 V DC (10% maximum ripple) at less than 35 mA (exclusive of load)

Output Configuration

Analog: 0 V to 10 V or 4 mA to 20 mA, depending on model
 Alarm: PNP

Output Protection

Protected against short-circuit conditions

Output Ratings

Analog Voltage: 2.5 kΩ minimum load resistance
 Analog Current: 1 kΩ maximum at 24 V input; max. load resistance = $[(V_{cc} - 4)/0.02]\Omega$
 For current output (4-20mA models): Ideal results are achieved when the total load resistance $R = [(V_{in} - 4)/0.02]\Omega$. **Example**, at $V_{in} = 24\text{ V DC}$, $R \approx 1\text{ k}\Omega$ (1 watt)
Alarm: Off-state leakage: < 10 microamps; Saturation: < 1.2 V at 10 mA and < 1.6 V at 100 mA

Delay at Power-Up

1.5 seconds

Output Response Time

75 ms (for a 95% step change)

Factory Defaults

Setting	Default
Taught Range ³	-20 °C to +280 °C (-4 °F to +536 °F)
Slope	Positive
Alarm High Temp	+280 °C (+536 °F)
Alarm Lo Temp	+265 °C (+509 °F)
Alarm Offset	50%
Alarm Configuration	PNP
Alarm Delay	Off
Alarm Hold	Off
Push Button	Enabled

Repeatability

± 1% of measurement, or ± 1 °C, whichever is greater

Minimum Taught Differential

10 °C

Linearity

From 0 °C to +50 °C: ± 2 °C
 From +50 °C to +300 °C: ± 1 °C or ± 1%, whichever is greater

Adjustments

TEACH configuration

Indicators

One bicolor (Green/Red) status LED, one Amber LED (see [Indicators](#) on p. 2)

Remote Teach Input

Impedance: 3 kΩ minimum load resistance

Construction

Threaded Barrel: 304 stainless steel
 Push Button Housing: ABS/PC
 Push Button: Santoprene
 Lightpipes: Acrylic

Operating Conditions

-20 °C to +70 °C (-4 °F to +158 °F)

Environmental Rating

Leakproof design, IP67; NEMA 6

Temperature Warm-Up Time

5 minutes

Certifications



² 0.04 sec < T < 0.8 sec

³ For maximum measurement performance, Banner recommends that the Temperature Measurement Range is within the specified 0 °C to +300 °C (+32 °F to +572 °F).

Required Overcurrent Protection



WARNING: Electrical connections must be made by qualified personnel in accordance with local and national electrical codes and regulations.

Overcurrent protection is required to be provided by end product application per the supplied table. Overcurrent protection may be provided with external fusing or via Current Limiting, Class 2 Power Supply. Supply wiring leads < 24 AWG shall not be spliced. For additional product support, go to www.bannerengineering.com.

Supply Wiring (AWG)	Required Overcurrent Protection (Amps)
20	5.0
22	3.0
24	2.0
26	1.0
28	0.8
30	0.5

Protection contre la surintensité requise



AVERTISSEMENT: Les raccordements électriques doivent être effectués par du personnel qualifié conformément aux réglementations et codes électriques nationaux et locaux.

Une protection de surintensité doit être fournie par l'installation du produit final, conformément au tableau fourni. Vous pouvez utiliser un fusible externe ou la limitation de courant pour offrir une protection contre la surtension dans le cas d'une source d'alimentation de classe 2. Les fils d'alimentation < 24 AWG ne peuvent pas être raccordés. Pour obtenir un support produit supplémentaire, rendez-vous sur le site www.bannerengineering.com.

Câblage d'alimentation (AWG)	Protection contre la surtension requise (ampères)
20	5.0
22	3.0
24	2.0
26	1.0
28	0.8
30	0.5

Application Note

The following are examples of materials with high and low emissivity. Additional examples can be found online.

Sensor-Friendly Materials (High Emissivity)	Materials to Sense with Caution (Low Emissivity)
<ul style="list-style-type: none"> Aluminum - anodized Asphalt Brick Carbon - lampblack or plate material Cardboard - corrugated or chipboard Concrete Glass - smooth, lead, or borosilicate (e.g., Pyrex®) Gypsum (including finished boards) 	<ul style="list-style-type: none"> Aluminum - plain or highly polished Copper Galvanized iron Stainless steel Vapor-deposited materials
<ul style="list-style-type: none"> Ice Iron and steel (except bright galvanized) Paper - most types, regardless of color Styrofoam® insulation Plastics Water Wood Rubber (for example, tires) 	

Dimensions

All measurements are listed in millimeters, unless noted otherwise.

Figure 4. M18T cabled models

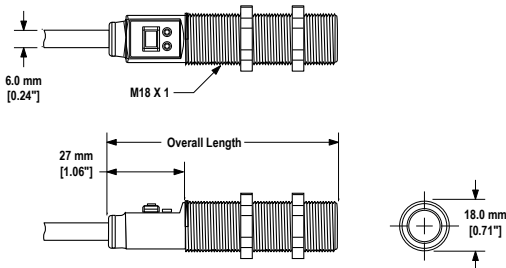

Overall Length	
Model M18T..8	81.2 mm [3.20"]
Model M18T..6E	81.7 mm [3.22"]
Model M18T..14	86.5 mm [3.41"]

Figure 5. M18T QD models

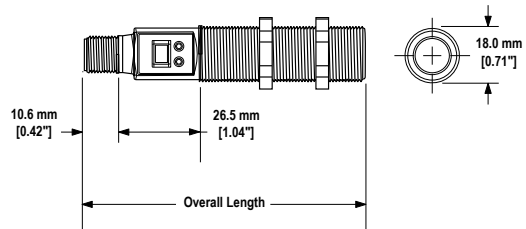

Overall Length	
Model M18T..8Q	91.3 mm [3.59"]
Model M18T..6EQ	91.8 mm [3.61"]
Model M18T..14Q	96.6 mm [3.80"]

Accessories

Cordsets

5-Pin Threaded M12 Cordsets with Shield—Single Ended				
Model	Length	Style	Dimensions	Pinout (Female)
MQDEC2-506	2 m (6.56 ft)	Straight		<p>1 = Brown 2 = White 3 = Blue 4 = Black 5 = Gray</p>
MQDEC2-515	5 m (16.4 ft)			
MQDEC2-530	9 m (29.5 ft)			
MQDEC2-550	15 m (49.2 ft)	Right-Angle		
MQDEC2-506RA	2 m (6.56 ft)			
MQDEC2-515RA	5 m (16.4 ft)			
MQDEC2-530RA	9 m (29.5 ft)			
MQDEC2-550RA	15 m (49.2 ft)			

Brackets

SMB18A

- Right-angle mounting bracket with a curved slot for versatile orientation
- 12-ga. stainless steel
- 18 mm sensor mounting hole
- Clearance for M4 (#8) hardware

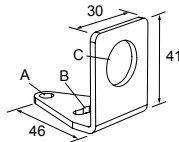

Hole center spacing: A to B = 24.2
Hole size: A = ϕ 4.6, B = 17.0 x 4.6, C = ϕ 18.5

SMB18SF

- 18 mm swivel bracket with M18 x 1 internal thread
- Black thermoplastic polyester
- Stainless steel swivel locking hardware included

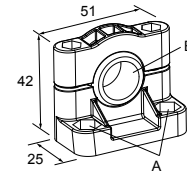

Hole center spacing: A = 36.0
Hole size: A = ϕ 5.3, B = ϕ 18.0

SMB18UR

- 2-piece universal swivel bracket
- 300 series stainless steel
- Stainless steel swivel locking hardware included
- Mounting hole for 18 mm sensor

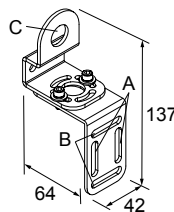

Hole center spacing: A = 25.4, B = 46.7
Hole size: B = 6.9 x 32.0, C = ϕ 18.3

Additional Accessories

Air-Purge Collar - APC-18

- Positive air pressure prevents water, dust, and other airborne contaminants from collecting on the sensor face.
- Air flow helps cool sensors affected by ambient heat in the sensing environment.
- Works with many of Banner's 18 mm threaded-barrel photoelectric and temperature sensors.

Note: Because air temperature affects the speed of sound, the Collar should not be used with ultrasonic sensors.

(Sensor not included)

