

Triple-Balanced Mixer

Rev. V4

Features

- LO 2 TO 18 GHz
- RF 1 TO 18 GHz
- IF 0.03 TO 5 GHz
- LO DRIVE: +13 dBm (NOMINAL)
- WIDE BANDWIDTH

Description

M83 is a triple balanced mixer, designed for use in military, commercial and test equipment applications. The design utilizes Schottky ring quad diodes and broadband soft dielectric baluns to attain excellent performance. The use of high temperature solder assembly processes used internally makes it ideal for use in manual, semi-automated assembly. Environmental screening available to MIL-STD-883, MIL-STD-202 or MIL-DTL-28837, consult factory.

Product Image

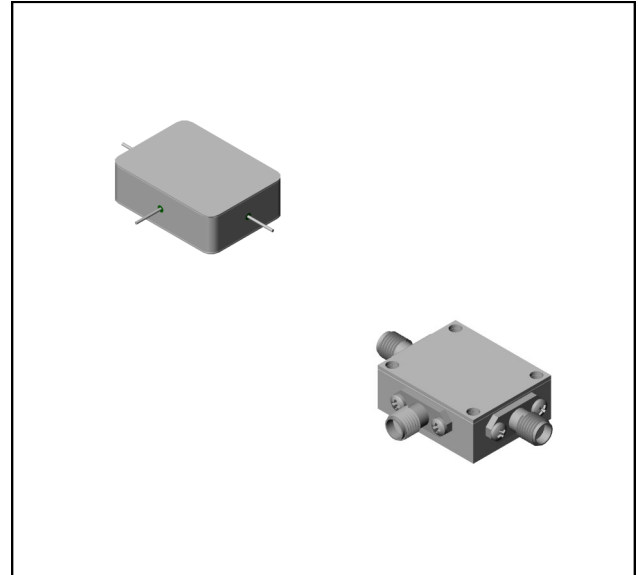

Ordering Information

Part Number	Package
M83	Minpac
M83C	SMA Connectorized

Electrical Specifications: $Z_0 = 50\Omega$ $Lo = +13$ dBm (Downconverter Application only)

Parameter	Test Conditions	Units	Typical	Guaranteed	
				+25°C	-54° to +85°C
SSB Conversion Loss (max) & SSB Noise Figure (max)	fR = 5 to 13 GHz, fL = 5 to 13 GHz, fl = 0.03 to 2 GHz	dB	6.5	8.0	8.5
	fR = 2 to 16 GHz, fL = 2 to 18 GHz, fl = 0.03 to 4 GHz	dB	7.5	9.0	9.5
	fR = 1 to 18 GHz, fL = 2 to 18 GHz, fl = 0.03 to 5 GHz	dB	8.5	10.0	10.5
Isolation, L to R (min)	fL = 2 to 3 GHz	dB	20	16	14
	fL = 3 to 18 GHz	dB	30	18	16
Isolation, L to I (min)	fL = 2 to 18 GHz	dB	30	20	18
1 dB Conversion Comp.	fL = +13 dBm	dBm	+6		
Input IP3	fR1 = 6 GHz at -3 dBm, fR2 = 3.01 GHz at -3 dBm, fL = 8 GHz at +13 dBm	dBm	+18		
	fR1 = 15 GHz at -3 dBm, fR2 = 15.01 GHz at -3 dBm, fL = 18 GHz at +13 dBm	dBm	+19		

Typical Performance Curves

Conversion Loss vs. LO Drive Power

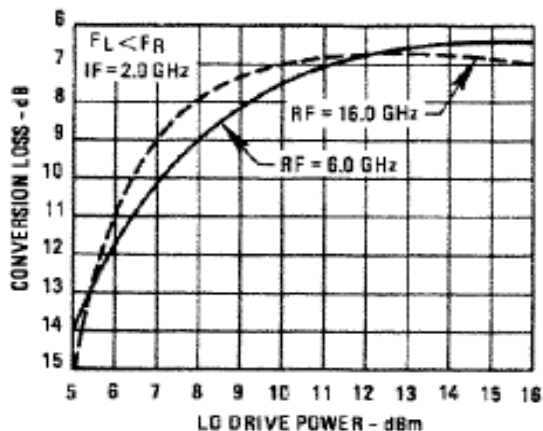

Conversion Loss

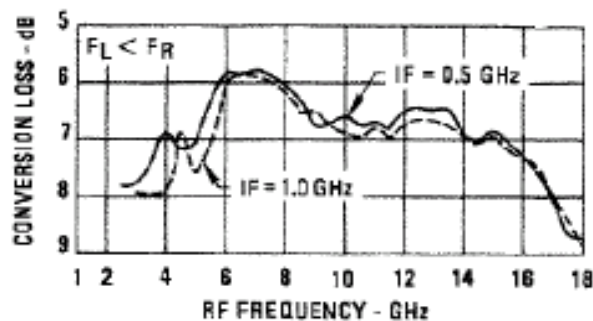

Conversion Loss

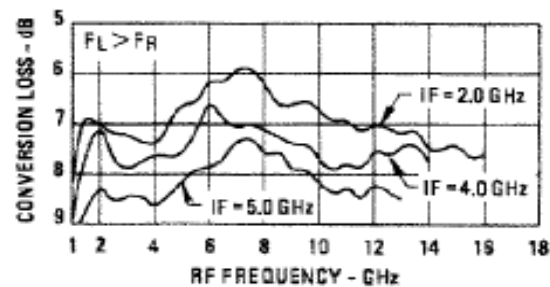
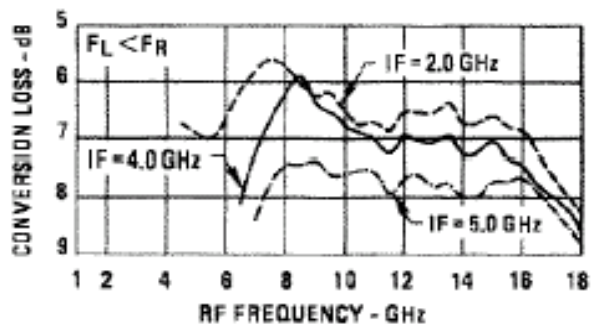
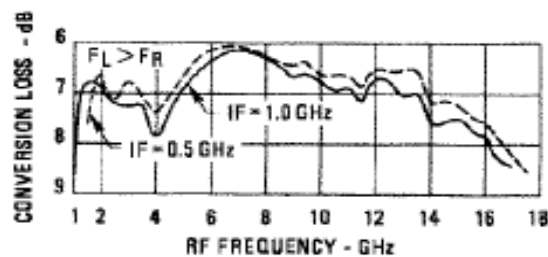

Isolation

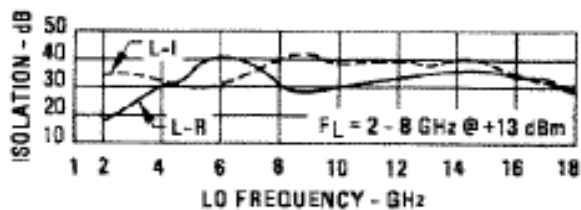

Triple-Balanced Mixer

Rev. V4

Absolute Maximum Ratings

Parameter	Absolute Maximum
Operating Temperature	-54°C to +100°C
Storage Temperature	-65°C to +100°C
Peak Input Power	+26 dBm max @ +25°C +23 dBm max @ +100°C
Peak Input Current	100 mA DC

Outline Drawing: Minpac *

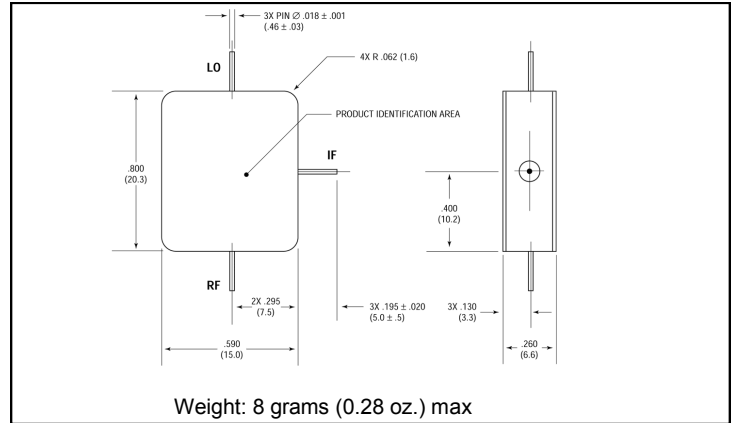

Outline Drawing: SMA Connectorized *

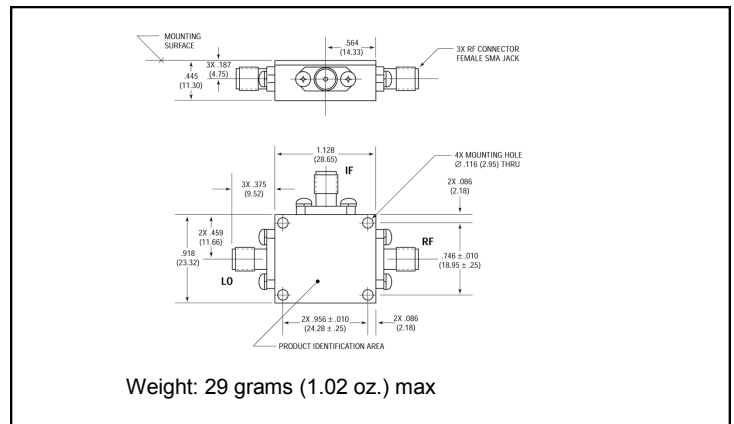

R-Port VSWR

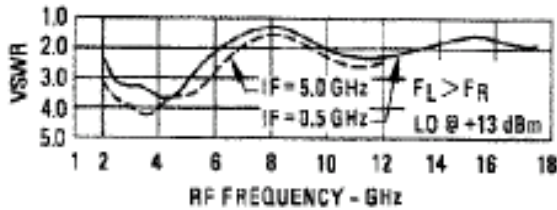
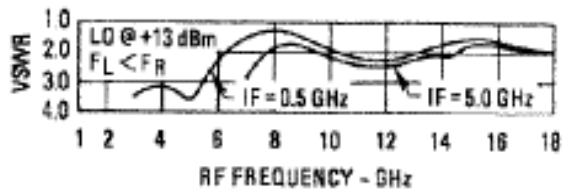

I-Port VSWR

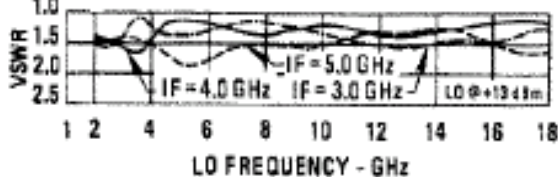
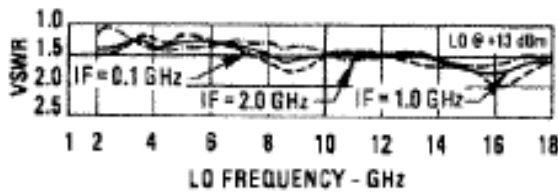

L-Port VSWR

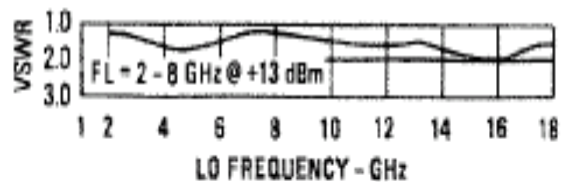

* Dimensions are inches (millimeters) ±0.015 (0.38) unless otherwise specified.