

## Triple-Balanced Mixer

Rev. V3

### Features

- LO 2 TO 18 GHz
- RF 2 TO 18 GHz
- IF 1 TO 8 GHz
- LO DRIVE: +13 dBm (NOMINAL)
- WIDE BANDWIDTH

### Description

M88 is a triple balanced mixer, designed for use in military, commercial and test equipment applications. The design utilizes Schottky ring quad diodes and broadband soft dielectric baluns to attain excellent performance. The use of high temperature solder assembly processes used internally makes it ideal for use in manual, semi-automated assembly. Environmental screening available to MIL-STD-883, MIL-STD-202 or MIL-DTL-28837, consult factory.

### Product Image

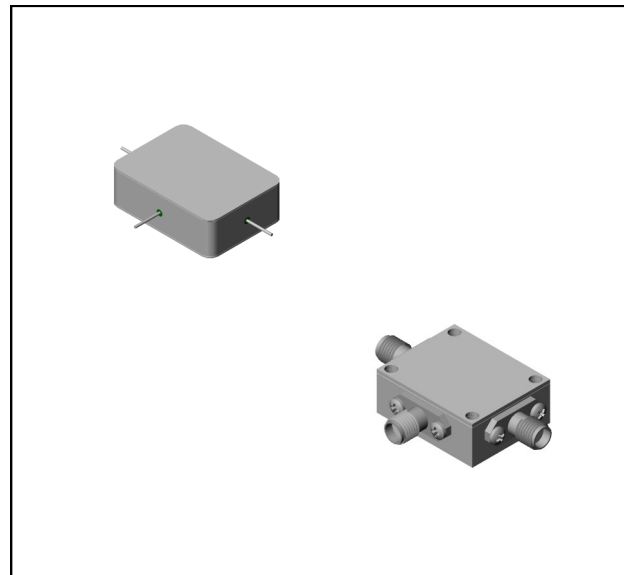

### Ordering Information

Part Number	Package
M88	Minpac
M88C	SMA Connectorized

### Electrical Specifications: $Z_0 = 50\Omega$ $Lo = +13$ dBm (Downconverter Application only)

Parameter	Test Conditions	Units	Typical	Guaranteed	
				+25°C	-54° to +85°C
SSB Conversion Loss (max) & SSB Noise Figure (max)	fR = 2 to 10 GHz, fL = 2 to 18 GHz, fI = 1 to 8 GHz fR = 10 to 18 GHz, fL = 10 to 18 GHz, fI = 2 to 8 GHz fR = 10 to 18 GHz, fL = 2 to 10 GHz, fI = 2 to 8 GHz	dB	7.5	10.0	10.5
			8.0	10.5	11.0
			8.0	11.0	11.5
Isolation, L to R (min)	fL = 2 to 18 GHz	dB	28	15	13
Isolation, L to I (min)	fL = 2 to 18 GHz	dB	32	16	14
1 dB Conversion Comp.	fL = +13 dBm	dBm	+7		
Input IP3	fR1 = 6 GHz at -3 dBm, fR2 = 6.01 GHz at -3 dBm, fL = 10 GHz at +13 dBm fR1 = 15 GHz at -3 dBm, fR2 = 15.01 GHz at -3 dBm, fL = 18 GHz at +13 dBm	dBm	+18.5		
			+22		

### Typical Performance Curves

Conversion Loss vs. Drive Power

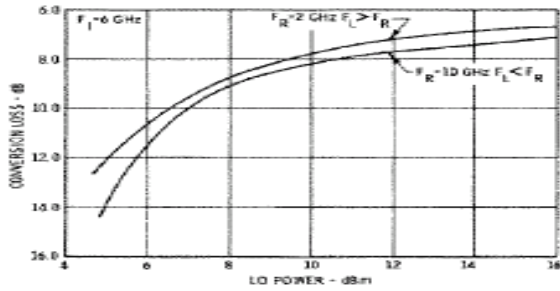

Conversion Loss vs. Frequency, LO @ +13 dBm

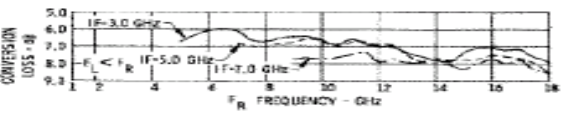
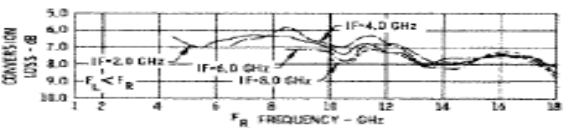
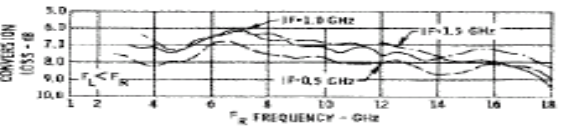
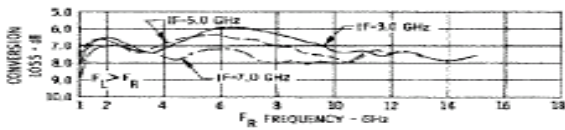
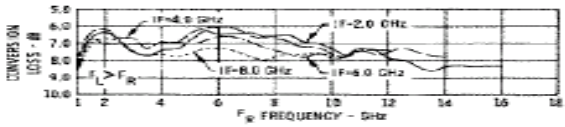
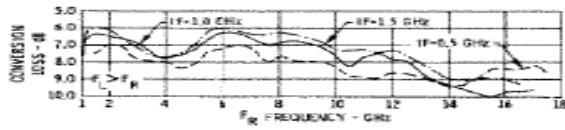

R-Port VSWR LO @ +13 dBm

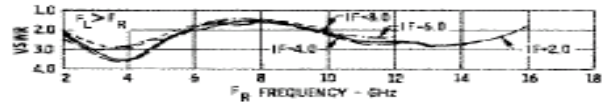
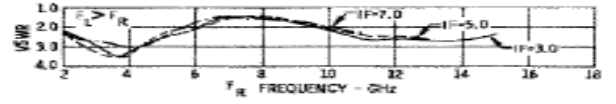
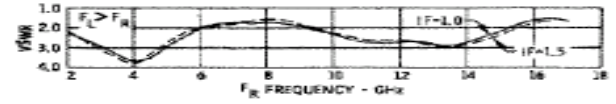

R-Port VSWR LO @ +13 dBm

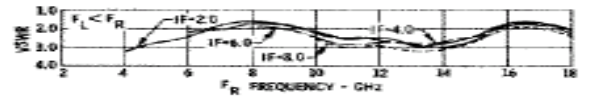
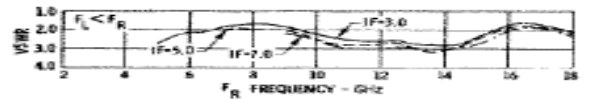
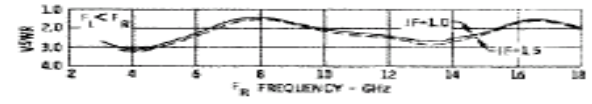

I-Port VSWR vs. Frequency, LO @ +13 dBm

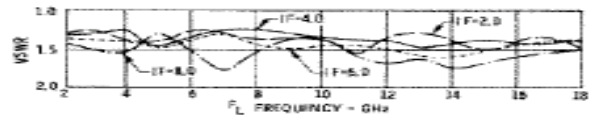
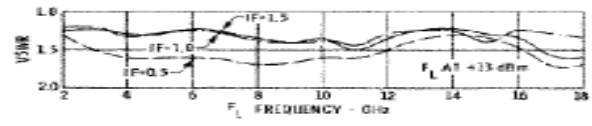

## Triple-Balanced Mixer

Rev. V3

### Absolute Maximum Ratings

Parameter	Absolute Maximum
Operating Temperature	-54°C to +100°C
Storage Temperature	-65°C to +100°C
Peak Input Power	+26 dBm max @ +25°C +23 dBm max @ +100°C
Peak Input Current	100 mA DC

### Isolation vs Frequency

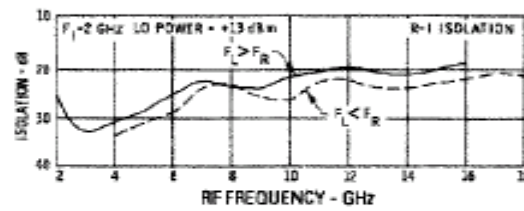
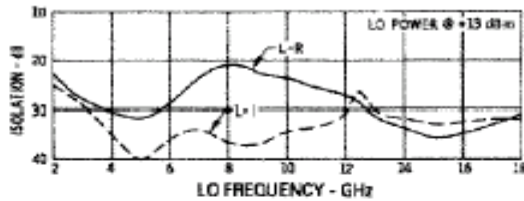

### L-Port VSWR

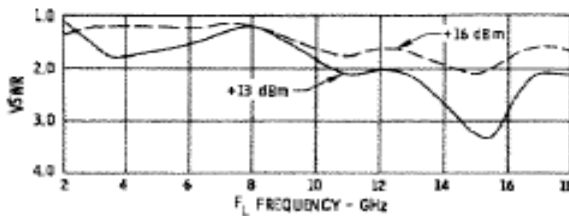

### Conversion Loss vs. Frequency & Temperature LO @ +13 dBm

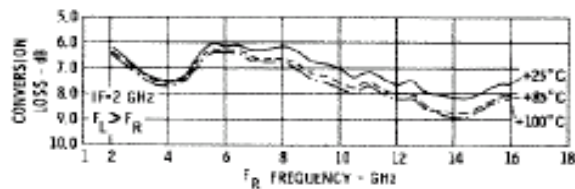

### Outline Drawing: Minpac \*

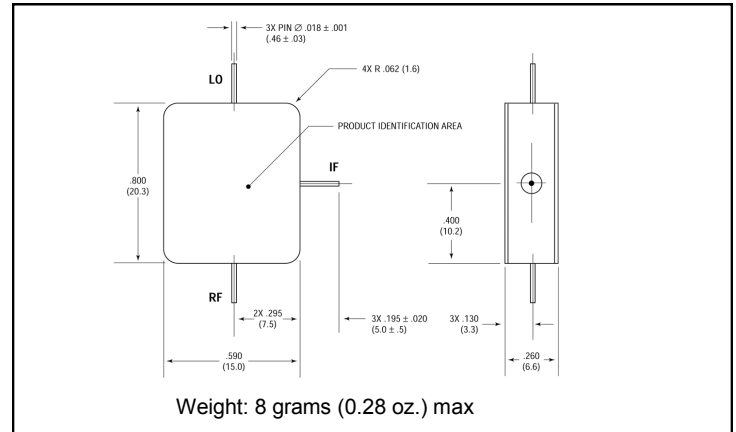

### Outline Drawing: SMA Connectorized \*

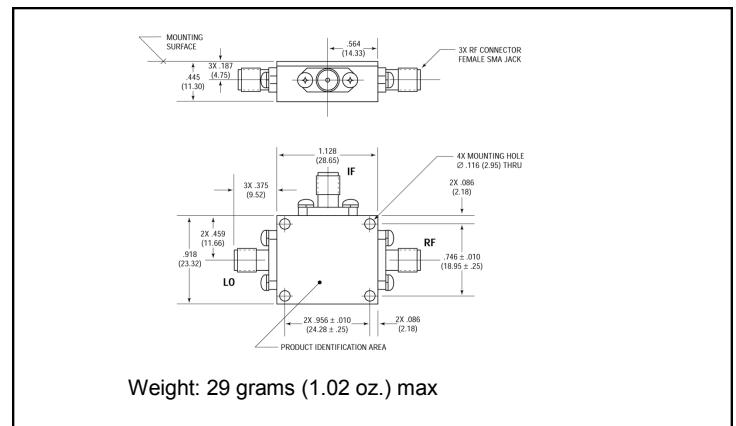

\* Dimensions are inches (millimeters) ±0.015 (0.38) unless otherwise specified.