

## Triple-Balanced Mixer

Rev. V2

### Features

- LO 2 TO 18 GHz
- RF 2 TO 18 GHz
- IF 2 TO 8 GHz
- LO DRIVE +21 dBm (nominal)
- WIDE BANDWIDTH
- HIGH THIRD-ORDER I.P. +24 dBm (TYP.)

### Description

M88H is a triple balanced mixer, designed for use in military, commercial and test equipment applications. The design utilizes Schottky ring quad diodes and broadband soft dielectric baluns to attain excellent performance. The use of high temperature solder assembly processes used internally makes it ideal for use in manual, semi-automated assembly. Environmental screening available to MIL-STD-883, MIL-STD-202 or MIL-DTL-28837, consult factory.

### Ordering Information

Part Number	Package
M88H	Minpac
M88HC	SMA Connectorized

### Product Image

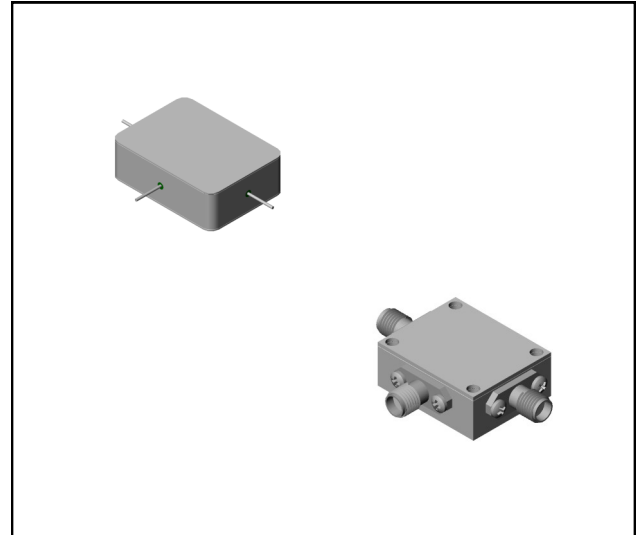

### Electrical Specifications: $Z_0 = 50\Omega$ $Lo = +21$ dBm (Downconverter Application only)

Parameter	Test Conditions	Units	Typical	Guaranteed	
				+25°C	-54° to +85°C
SSB Conversion Loss (max) & SSB Noise Figure (max)	fR = 2 to 10 GHz, fL = 2 to 18 GHz, fI = 2 to 8 GHz fR = 10 to 18 GHz, fL = 2 to 18 GHz, fI = 2 to 8 GHz	dB dB	7.5	10.0	10.3
			8.0	10.5	10.8
Isolation, L to R (min)	fL = 2 to 18 GHz	dB	28	15	14
Isolation, L to I (min)	fL = 2 to 18 GHz	dB	32	17	16
1 dB Conversion Comp.	fL = +21 dBm	dBm	+17		
Input IP3	fR1 = 6 GHz at 0 dBm, fR2 = 6.01 GHz at 0 dBm, fL = 8 GHz at +21 dBm fR1 = 14 GHz at 0 dBm, fR2 = 14.01 GHz at 0 dBm, fL = 10 GHz at +21 dBm	dBm dBm	+26		
			+24		

## Triple-Balanced Mixer

Rev. V2

### Typical Performance Curves

Conversion Loss vs Lo Drive Power

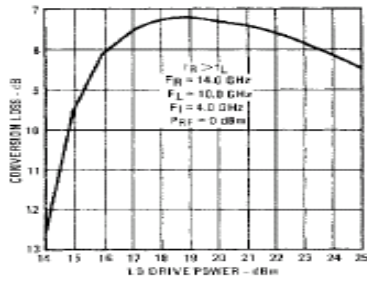

Drive Level: The maximum recommended drive level is +24 dBm.

Conversion Loss vs Input Frequency  
Lo @ +21 dBm

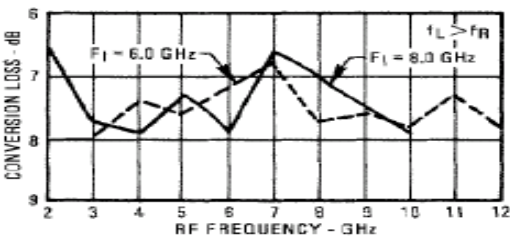
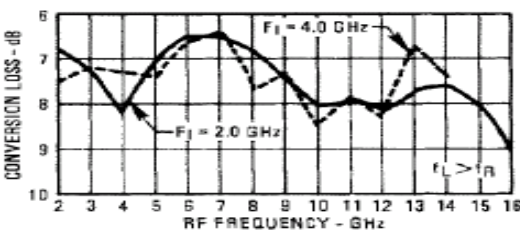
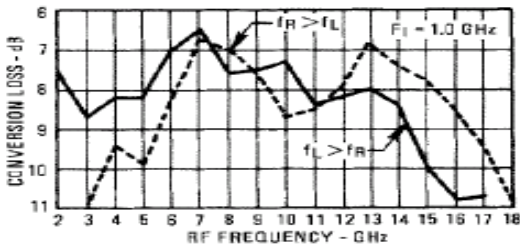

R-Port VSWR Lo @ +21 dBm

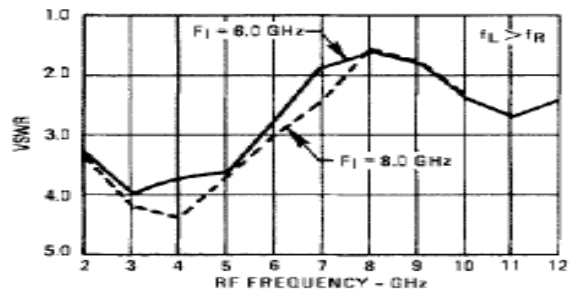
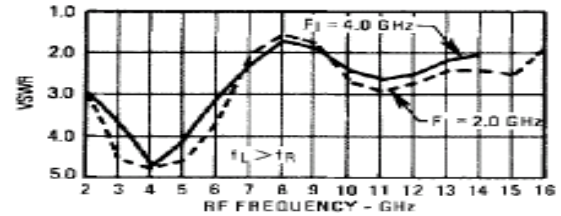
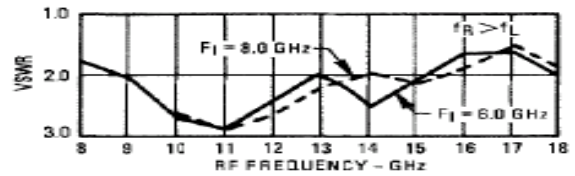
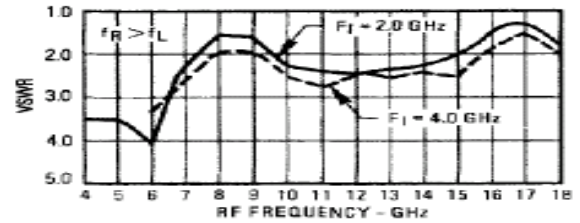

## Triple-Balanced Mixer

Rev. V2

### Absolute Maximum Ratings

Parameter	Absolute Maximum
Operating Temperature	-54°C to +100°C
Storage Temperature	-65°C to +100°C
Peak Input Power	+27 dBm max @ +25°C +24 dBm max @ +100°C
Peak Input Current	100 mA DC

### Isolation vs Frequency

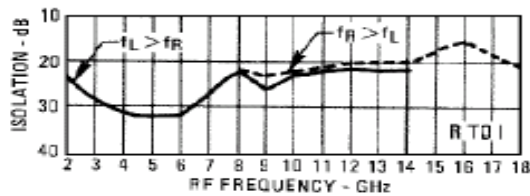
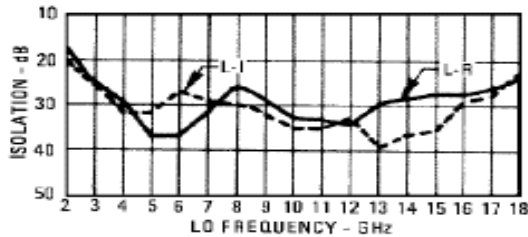

### L-Port VSWR @ +21 dBm

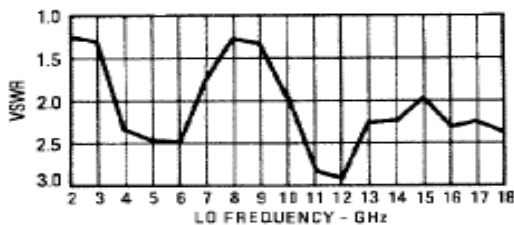

### Outline Drawing: Minpac \*

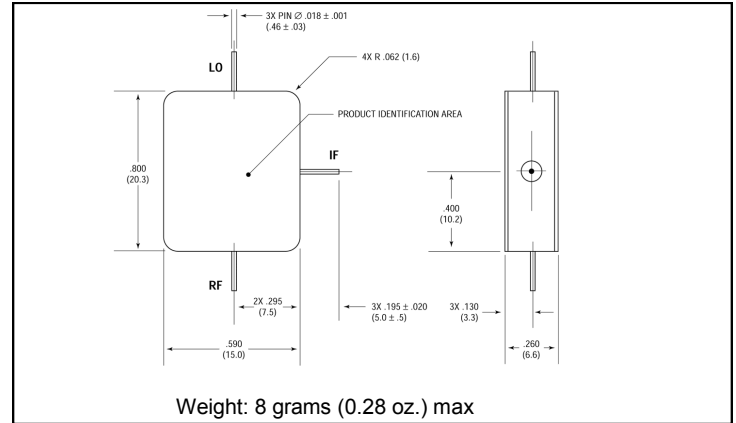

### Outline Drawing: SMA Connectorized \*

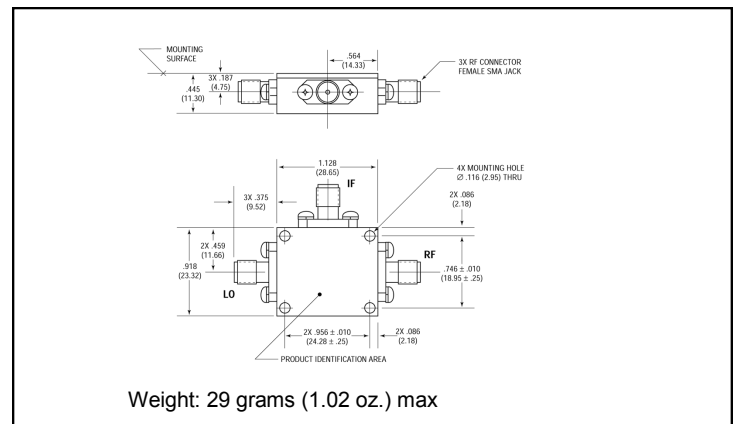

\* Dimensions are inches (millimeters) ±0.015 (0.38) unless otherwise specified.