



TAOGLAS®



Datasheet

Supercombo Permanent Mount 5-in-1 Antenna

Part No:
MA1045.A.ALBTX.002

Description:
MA1045 – 5-in-1 2*GPS, LTE, SiriusXM & AM/FM

Features:
Combination Antenna Vehicle Mount Antenna
2* GPS Antenna: FAKRA Code C Blue
1* LTE with fallback to 3G/2G: FAKRA Code D Bordeaux Violet
1* SiriusXM: FAKRA Code K Curry Yellow
1* AM/FM: FAKRA Code A Black
Cable: 300mm RG-174
IP67 Rated Waterproof
Manufactured in TS16949 Automotive Approved Facilities
RoHS & Reach Compliant

1. Introduction	3
2. Specifications	4
3. Antenna Characteristics	6
4. Radiation Patterns	16
5. Mechanical Drawing	28
6. Packaging	29
<hr/>	
Changelog	30

Taoglas makes no warranties based on the accuracy or completeness of the contents of this document and reserves the right to make changes to specifications and product descriptions at any time without notice. Taoglas reserves all rights to this document and the information contained herein.

Reproduction, use or disclosure to third parties without express permission is strictly prohibited.



1. Introduction



The MA1045 Supercombo Vehicle Mount 5in1 Antenna is the world's smallest next-generation 5in1, vehicle roof permanent mount solution. Fully IP67 waterproof with robust ABS+PC housing. The antenna is approved for use on heavy-duty trucks and meets the strictest OEM heavy-duty truck standards. It supports the following bands: Two GPS outputs, LTE (4G/3G/2G), SiriusXM, and AM/FM/WB.

The antenna is a first tier TS16949 heavy-duty truck approved and is an ideal choice for Automotive Telematic and heavy-duty plant applications.

The antenna comes with low-loss RG-174 coaxial pigtail cables as standard, terminating in FAKRA Code C for GPS, FAKRA Code A for AM/FM/WB, FAKRA Code K for SiriusXM, and with FAKRA SMB code D for LTE. The SiriusXM antenna meets the latest (Gen 3) specifications.

The LTE antenna provides the highest efficiency on all common worldwide LTE bands and also works great if the system falls back to 3G and 2G as it also covers these cellular bands. The AM/FM/WB antenna has an in-built amplifier to increase receive signal sensitivity. The antenna works in conjunction with a 12v DC wire that powers the AM/FM/WB circuits. The antenna is manufactured in TS16949 automotive approved facilities.

Contact your regional Taoglas customer service team for more information or installation guidelines.

2. Specifications

Cellular Antenna							
Frequency (MHz)	698~803	824~894	880~960	1710~1880	1850~1990	1920~2170	2300~2500
Efficiency (%)							
	51	44	46	38	38	36	44
Peak Gain (dBi)							
	0.6	2.7	2.7	4.4	2.2	1.2	4.6
Average Gain (dB)							
	-2.7	-3.1	-3.3	-4.1	-4	-4.3	-3.5
Impedance	50 Ω						

SiriusXM Antenna	
Frequency (MHz)	2320~2345
Efficiency (%)	
64	
Peak Gain (dBi)	
5.4	
Average Gain (dB)	
-1.9	
Polarization	LHCP

GPS Antenna(Feed 1)	
Frequency	BeiDou : 1561.098 ± 2.046MHz. GPS : 1575.42 ± 1.023MHz
Return loss (GPS L1)	< -10 dB
Passive Gain at Zenith (GPS L1)	+3dBi typ.
Average Gain (GPS L1)	-4.5dB
Polarization	RHCP
Impedance	50 Ω

GPS Antenna(Feed 2)	
Frequency	BeiDou : 1561.098 ± 2.046MHz. GPS : 1575.42 ± 1.023MHz
Return loss (GPS L1)	< -10 dB
Passive Gain at Zenith (GPS L1)	+3dBi typ.
Average Gain (GPS L1)	-4.5dB
Polarization	RHCP
Impedance	50 Ω

Mechanical	
Dimensions	165.45*96.61*61.45mm
Cable	RG-174
Connector	GPS(1 & 2): FAKRA Code C Blue AM/FM/WB: BNC(F)ST SiriusXM: FAKRA Code K Curry LTE: FAKRA Code D
Casing	ASA+PC w/UV Stabilizer
Sealant	Silicone
Weight	0.23kg
Environmental	
IP Rating	IP67
Temperature Range	-40°C to 85°C
Thermal Shock	IEC 60068-2-14
Humidity	Non-condensing 65°C 95% RH
Cable Pull	35.59N
Recommended Mounting Torque	6.78Nm
Maximum Mounting Torque	8.13Nm

3. Antenna Characteristics

3.1 LTE

Return Loss

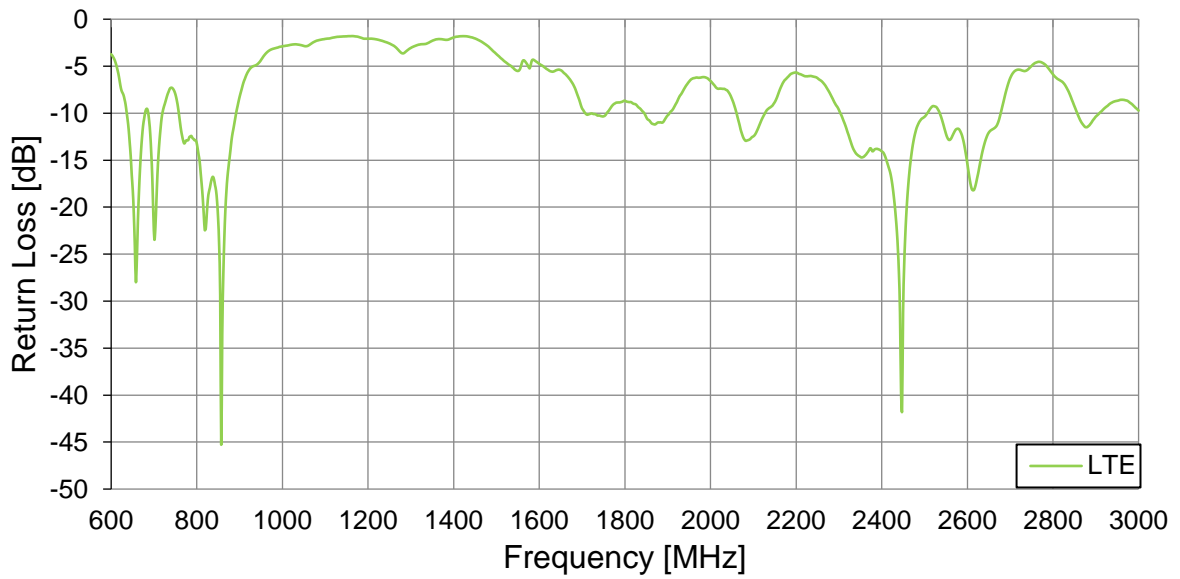

Efficiency

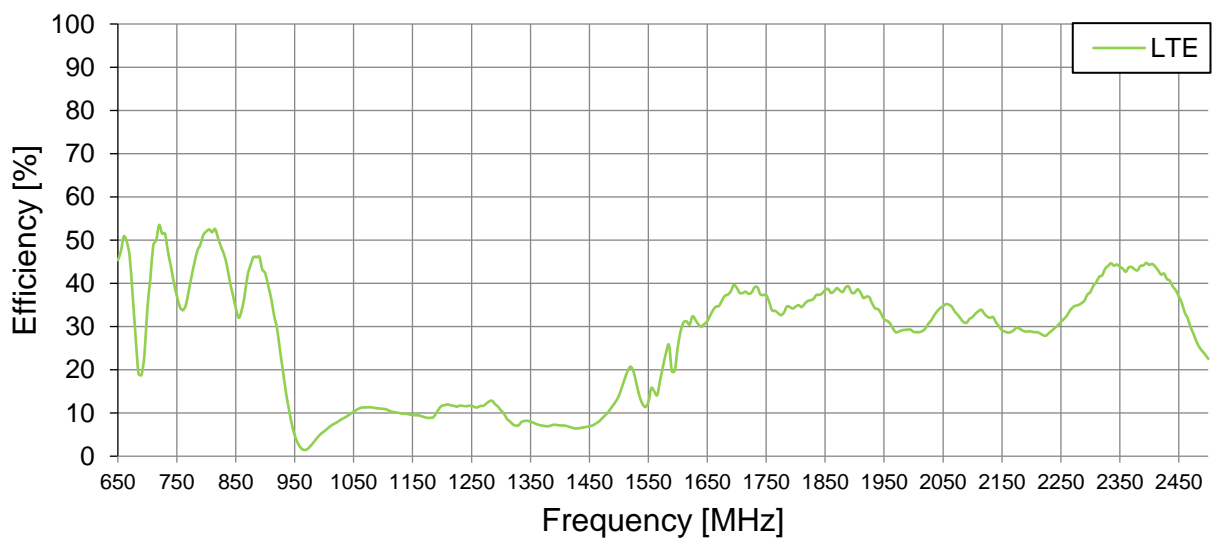

Average Gain

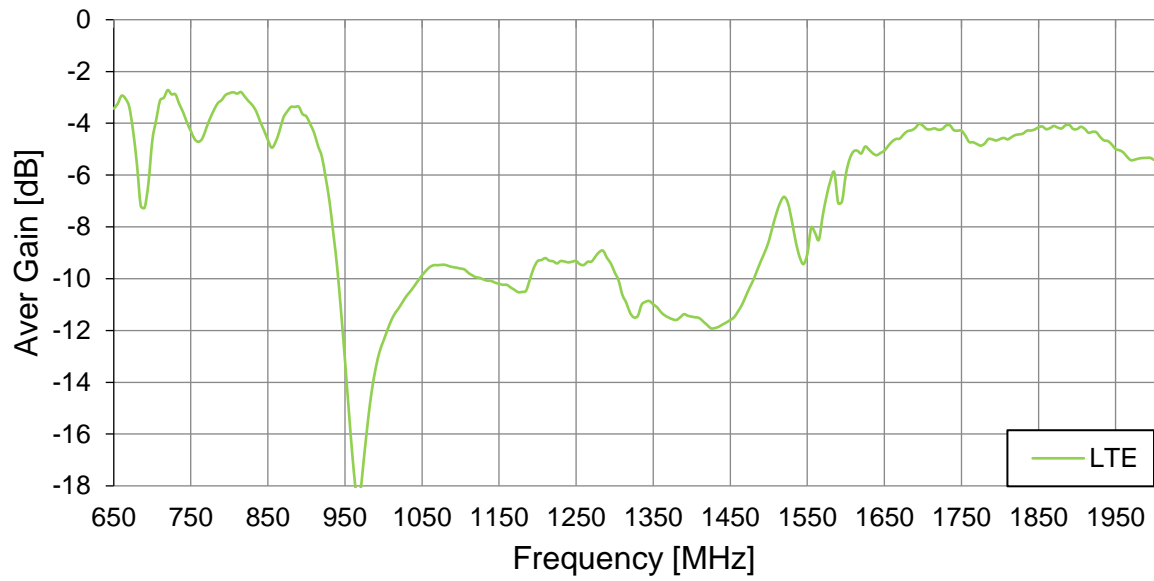

Peak Gain

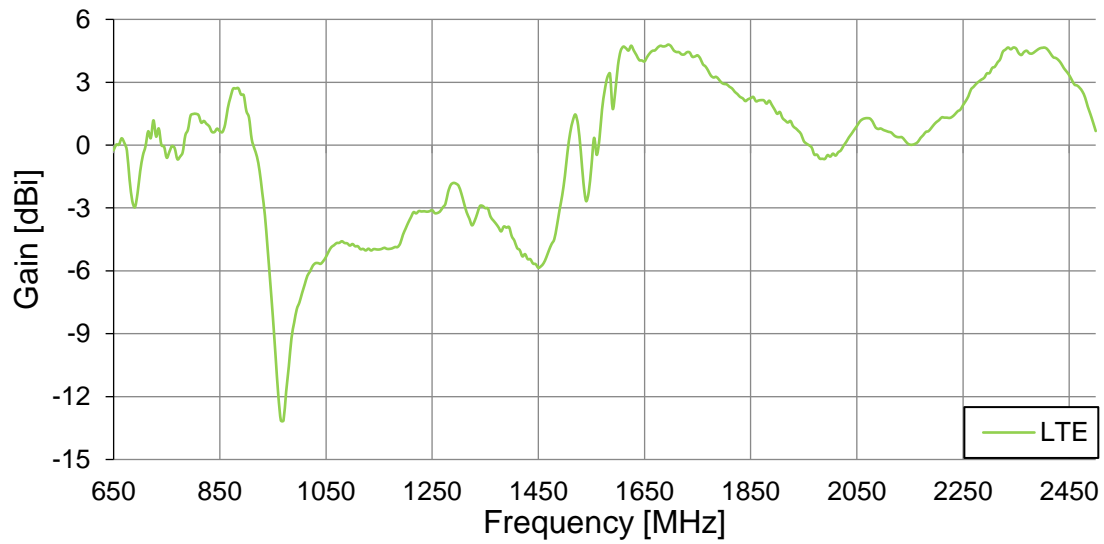

3.2 SiriusXM Antenna

Return Loss

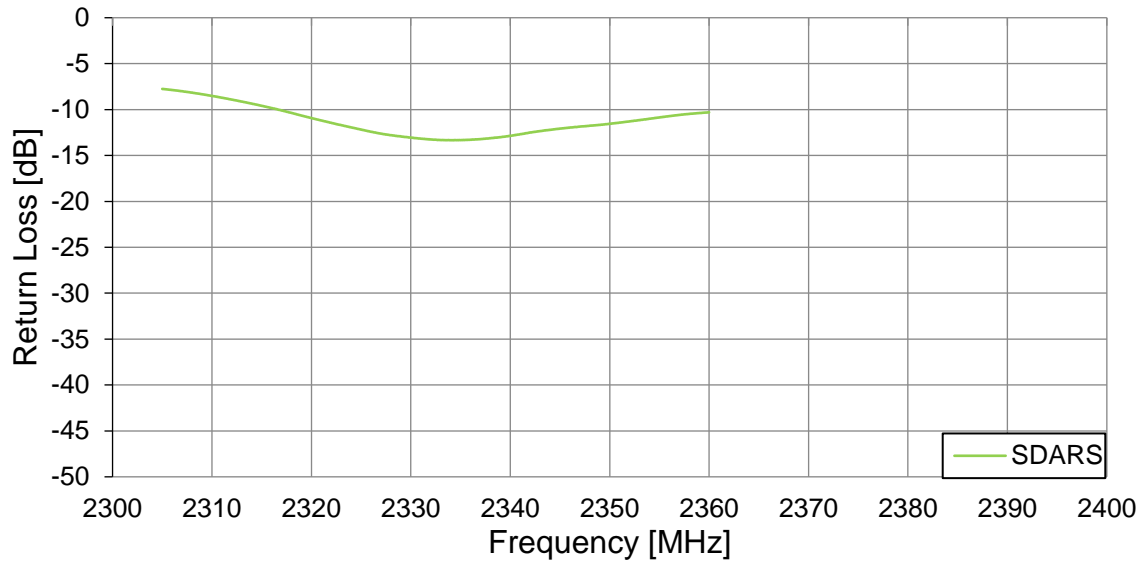

Efficiency

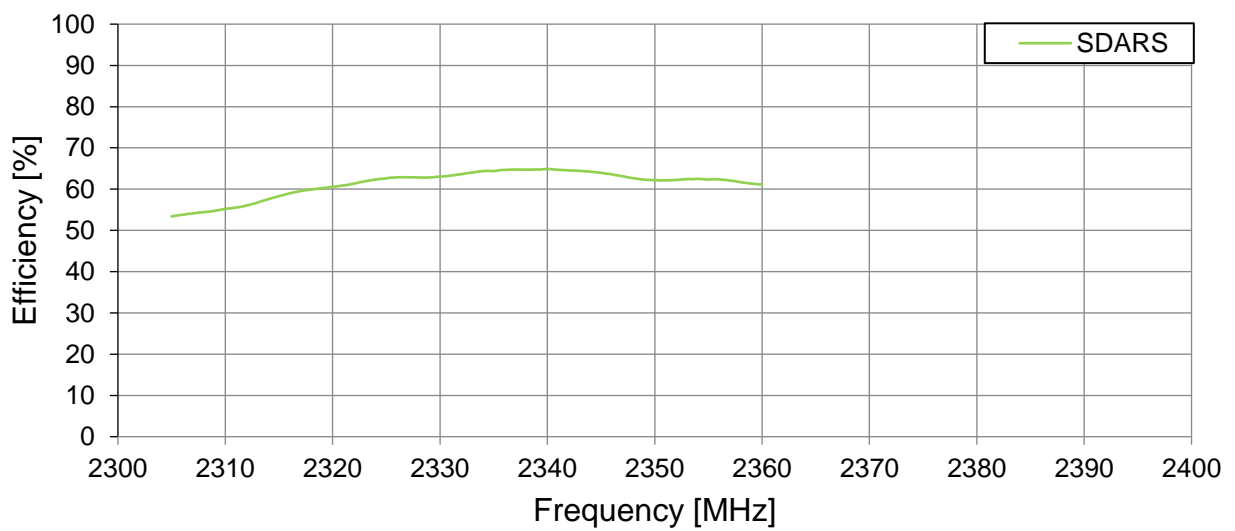

Average Gain

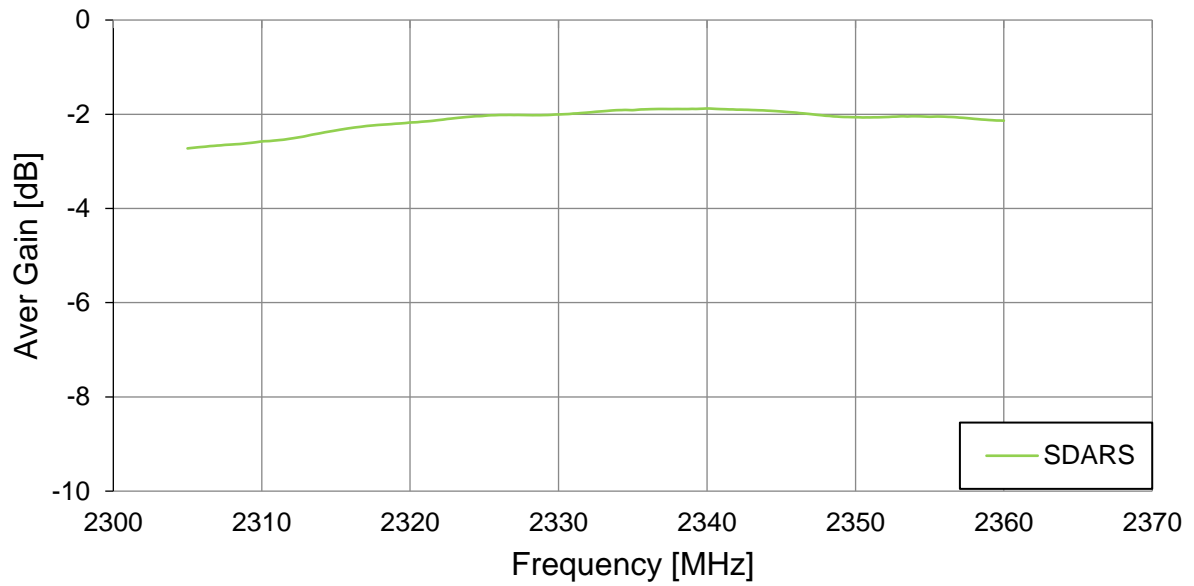

Peak Gain

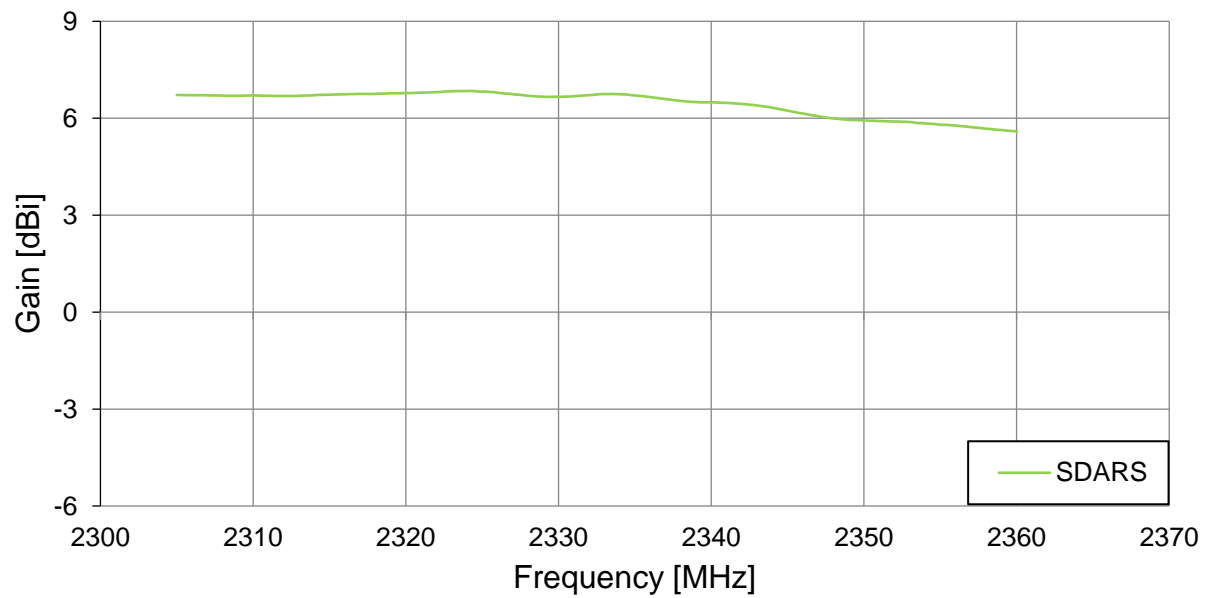

3.3 GPS Antenna Feed 1

Return Loss

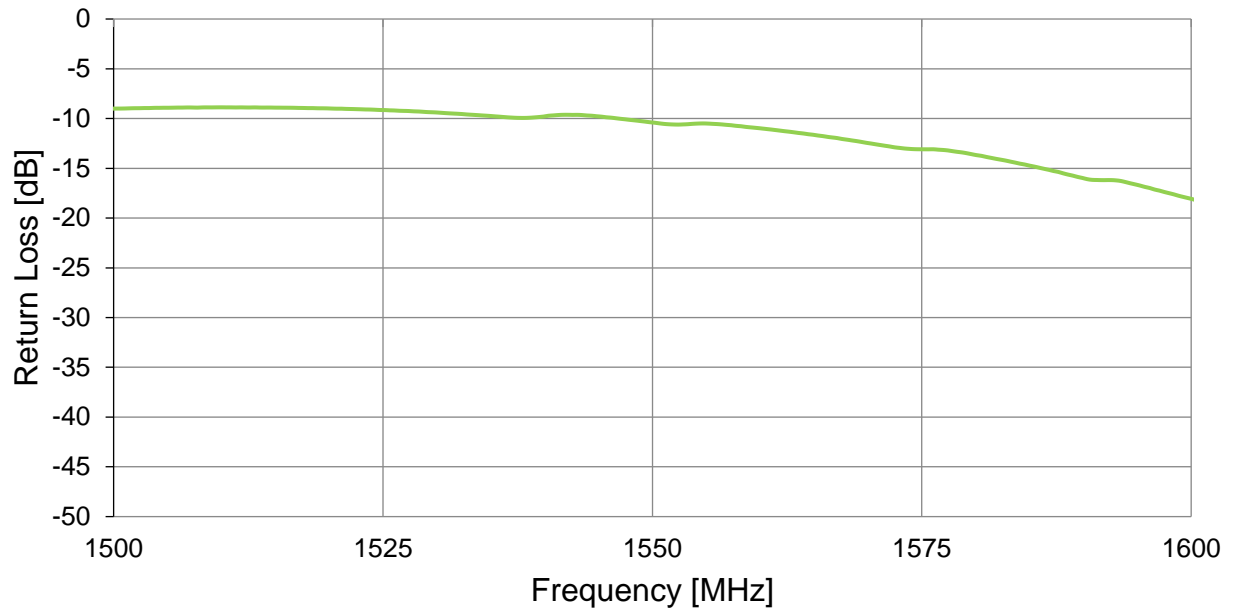

Efficiency

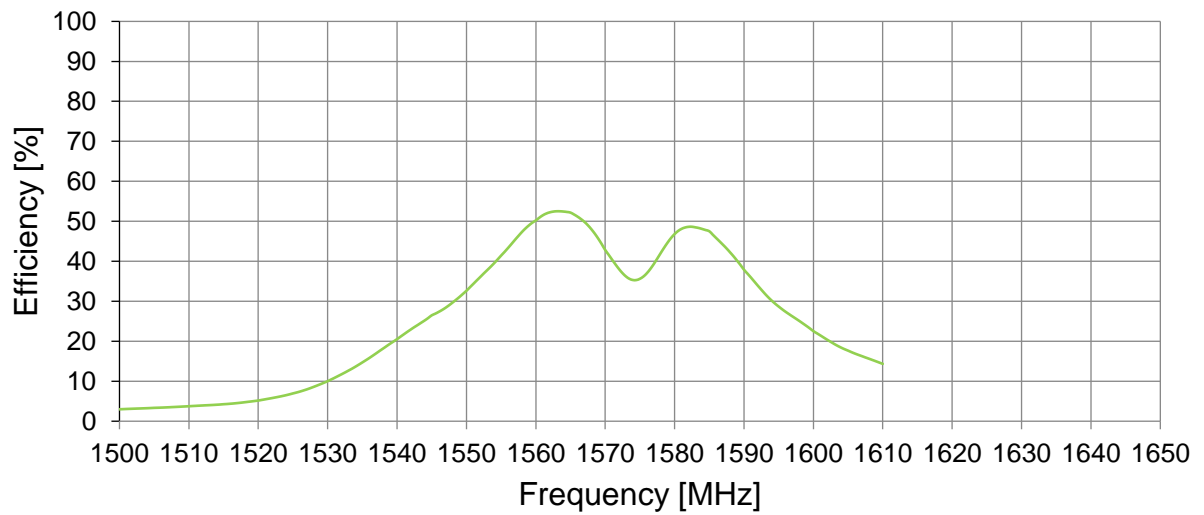

Average Gain

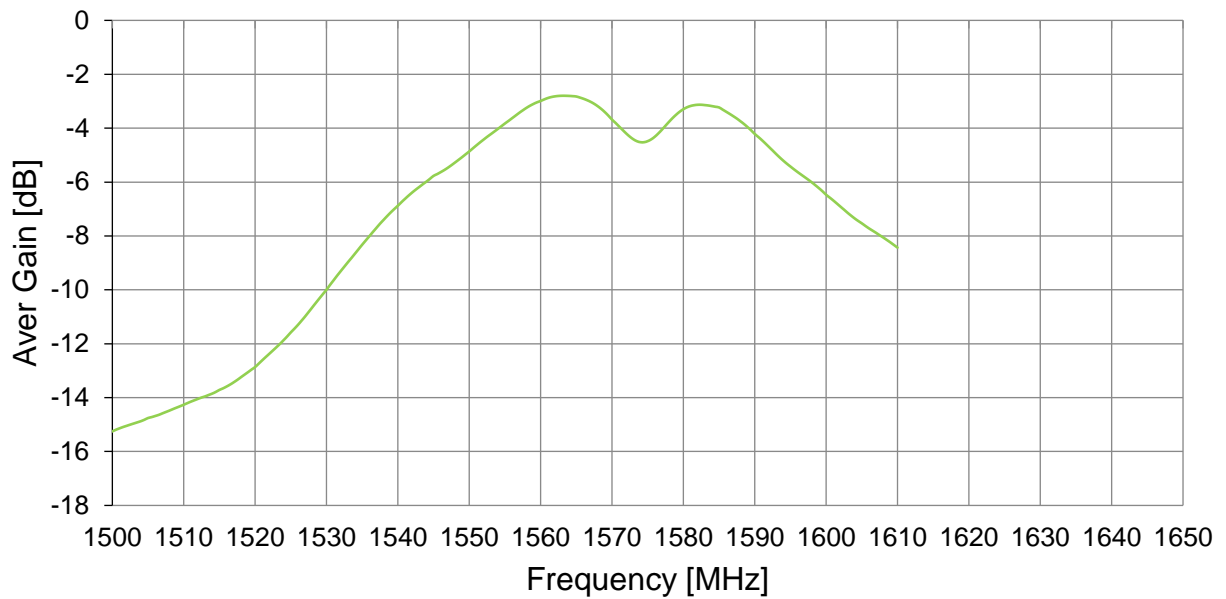

Peak Gain

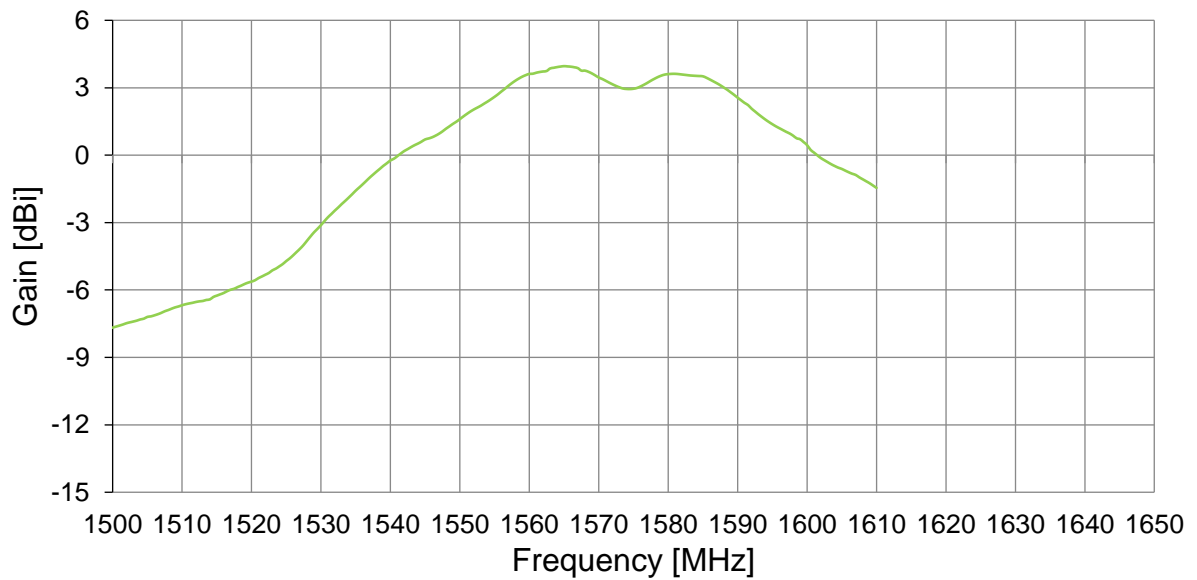

Axial Ratio XZ Plane @ 1575.5MHz

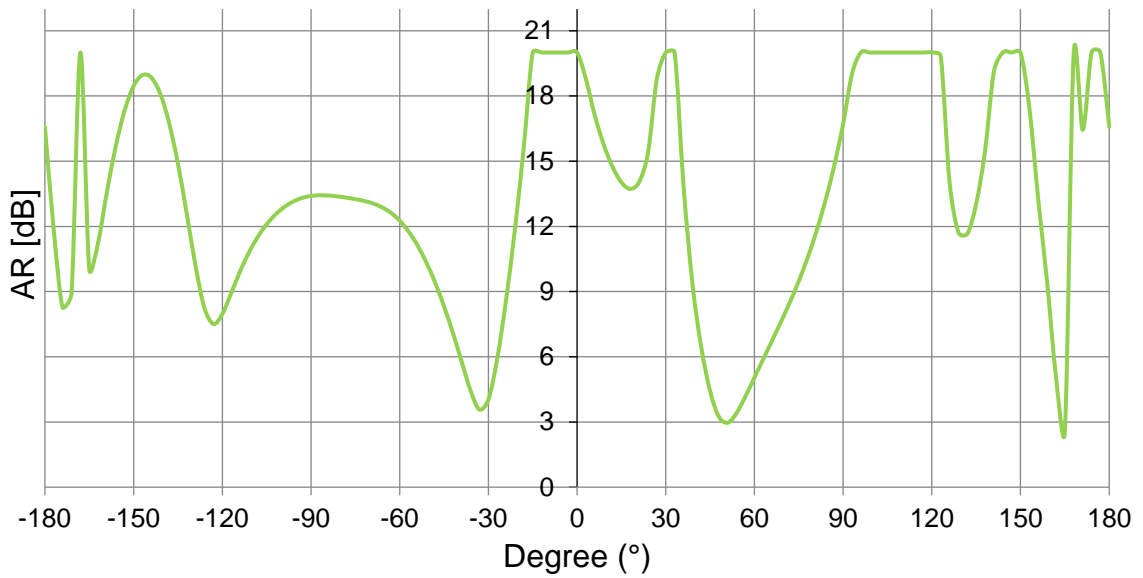

Axial Ratio YZ Plane @ 1575.5MHz

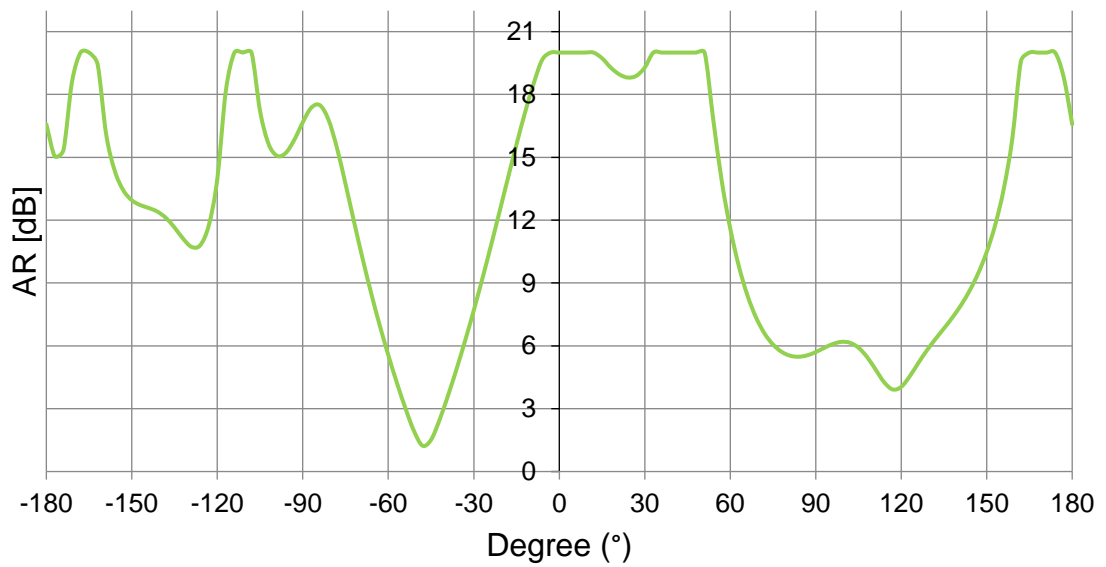

3.3 GPS Antenna Feed 2

Return Loss

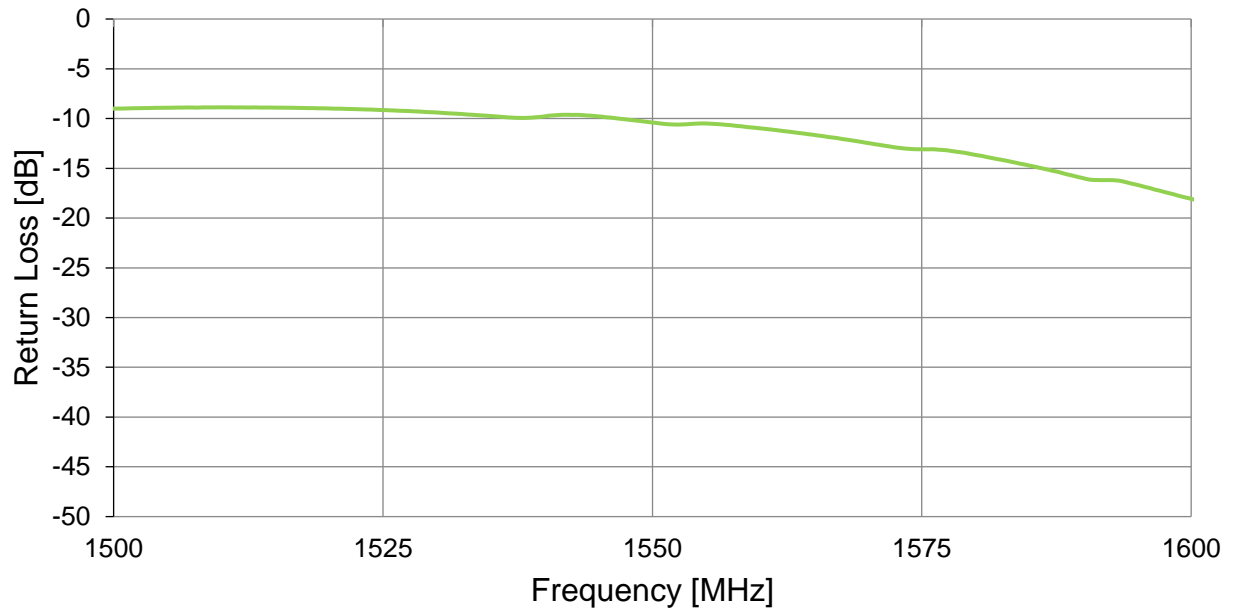

Efficiency

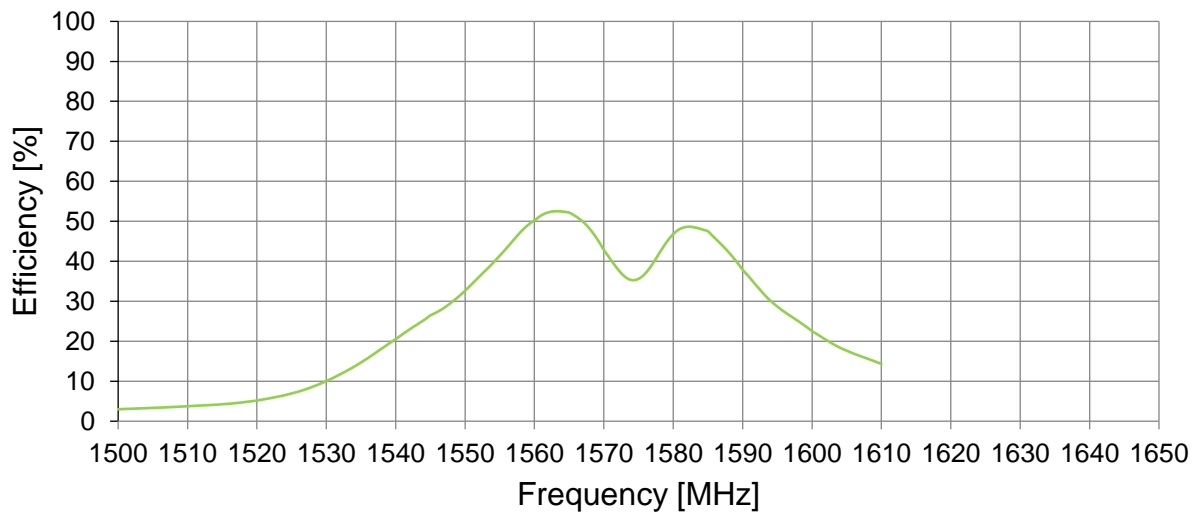

Average Gain

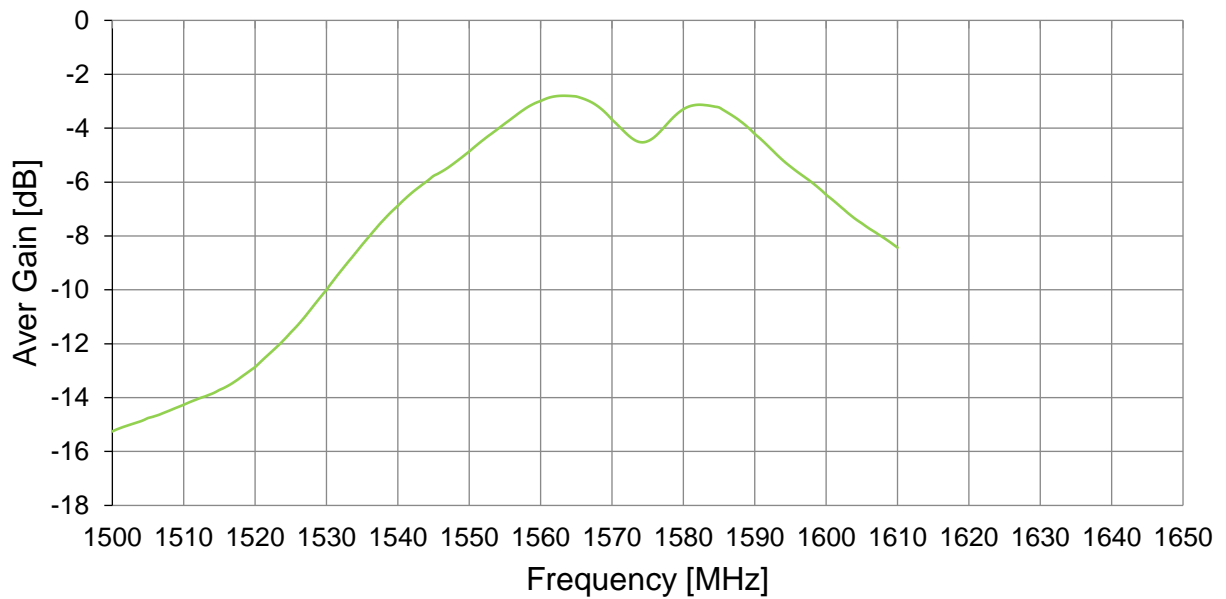

Peak Gain

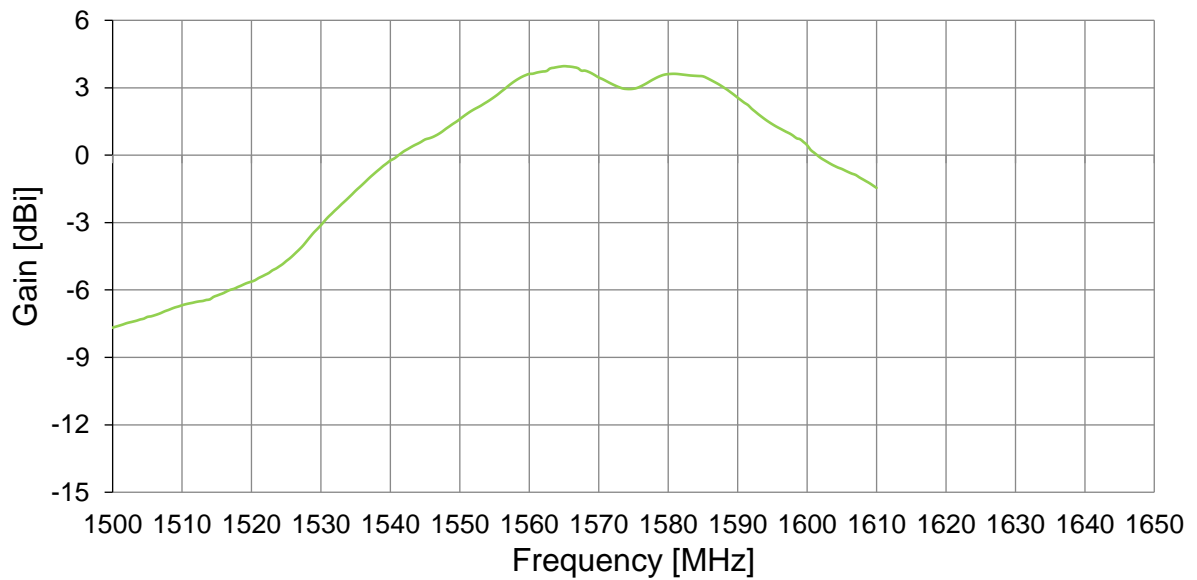

Axial Ratio XZ Plane @ 1575.5MHz

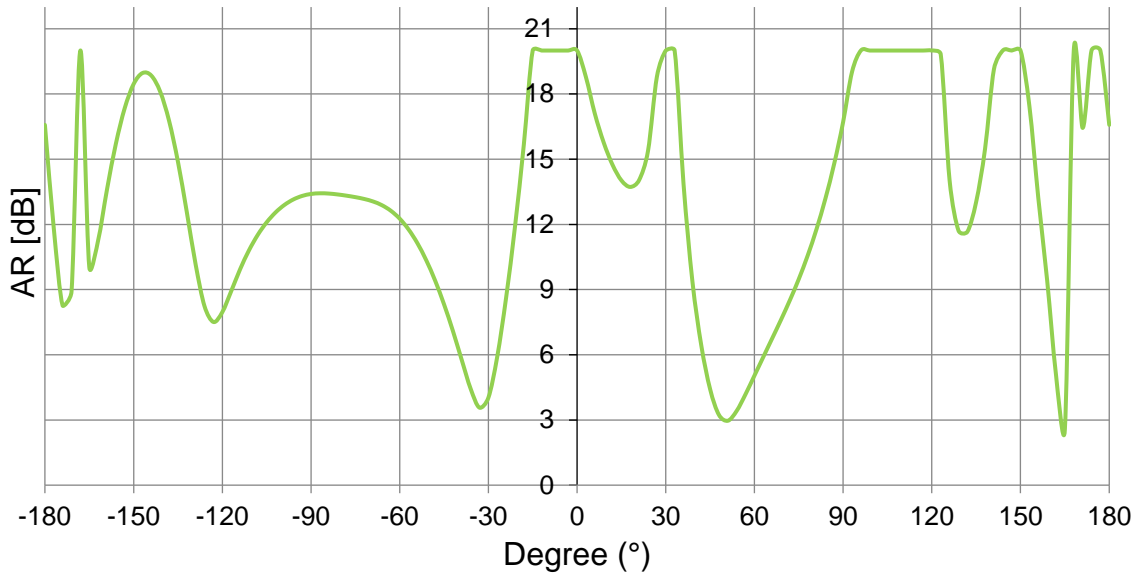

Axial Ratio YZ Plane @ 1575.5MHz

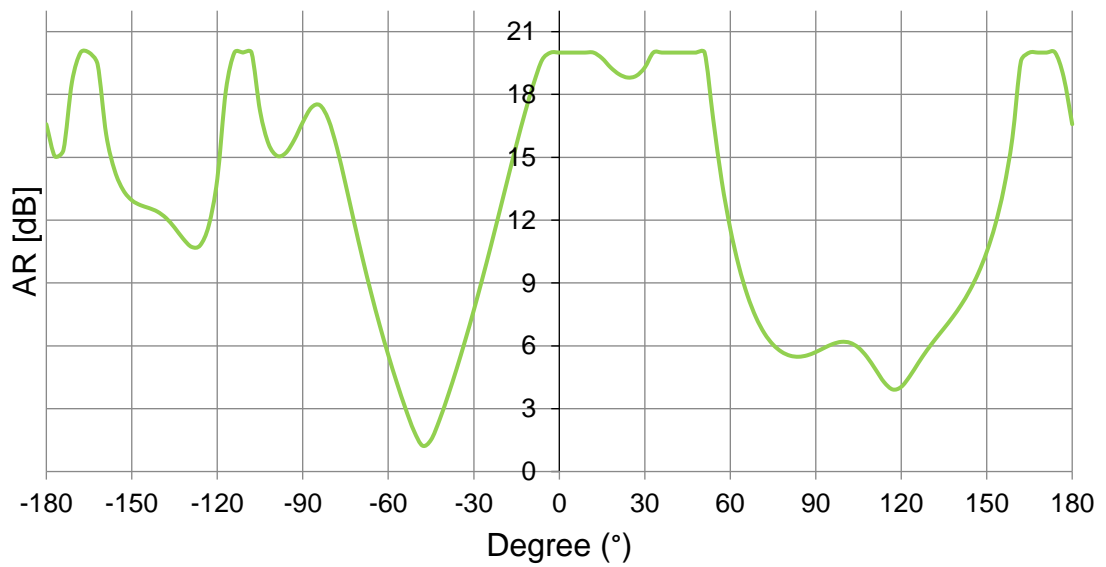

4. 2D Radiation Patterns

4.1 Test Setup



4.2 LTE 698MHz 3D and 2D Radiation Patterns

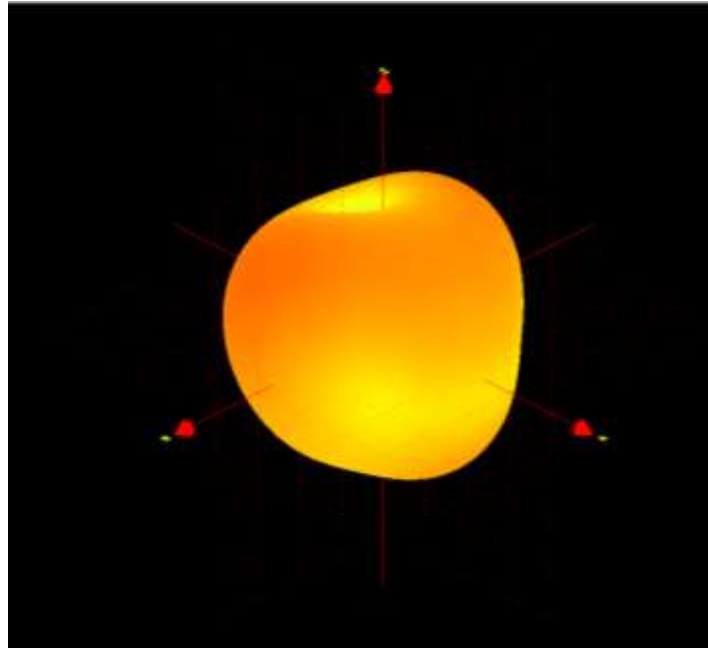

XY Plane

XZ Plane

YZ Plane

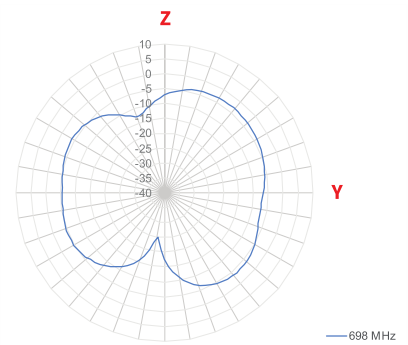
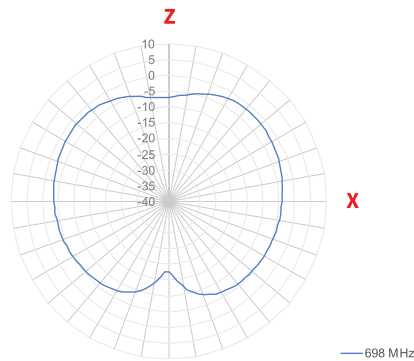
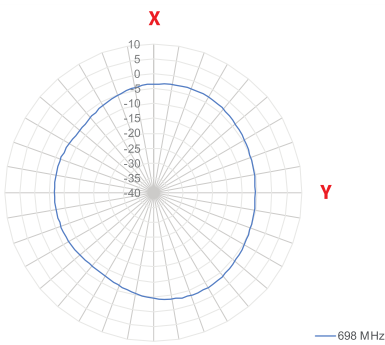

4.3 LTE 824MHz 3D and 2D Radiation Patterns

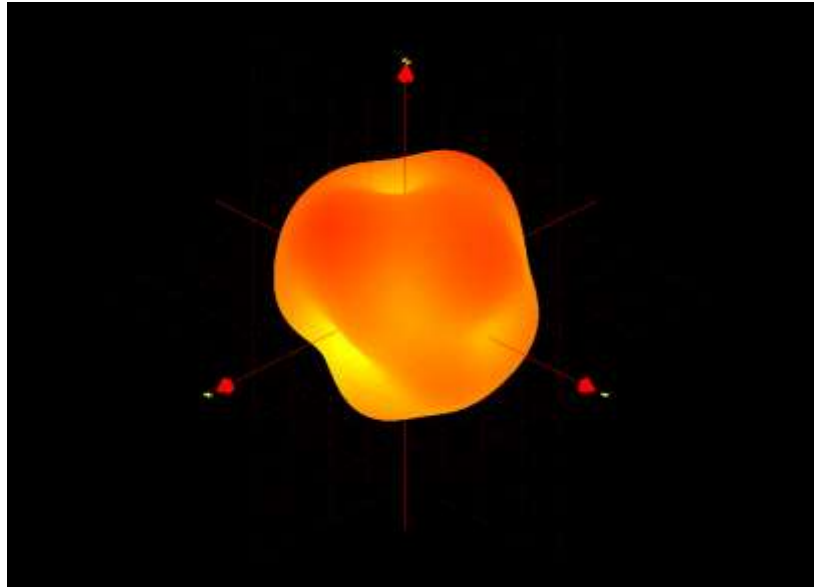

XY Plane

XZ Plane

YZ Plane

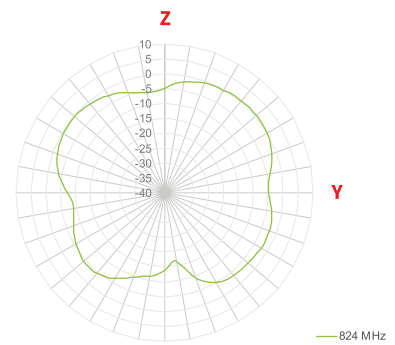
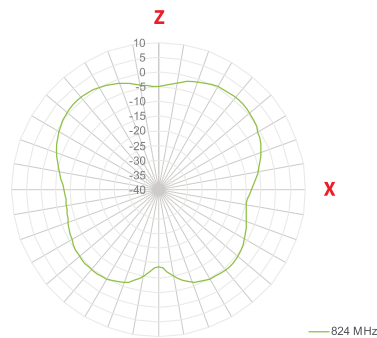
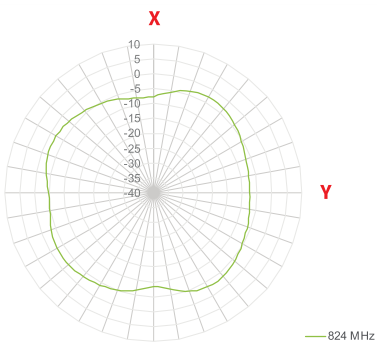

4.4 LTE 960MHz 3D and 2D Radiation Patterns

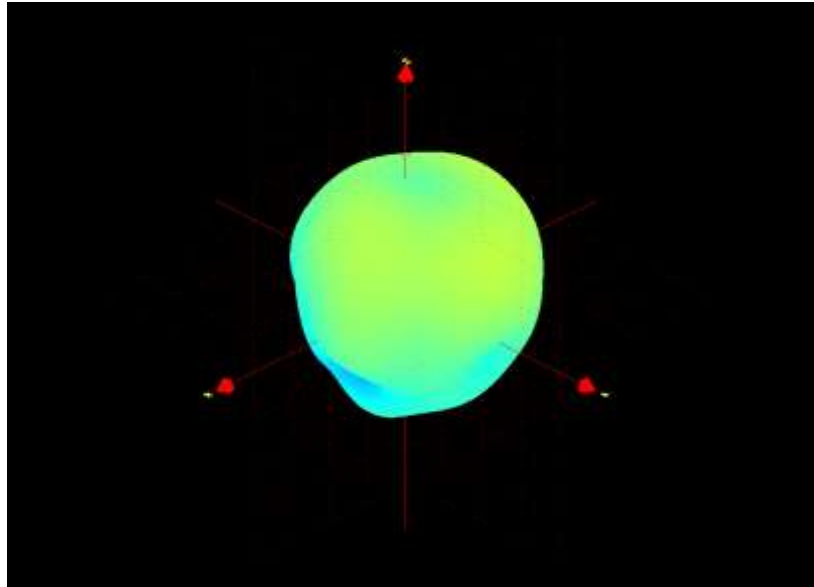

XY Plane

XZ Plane

YZ Plane

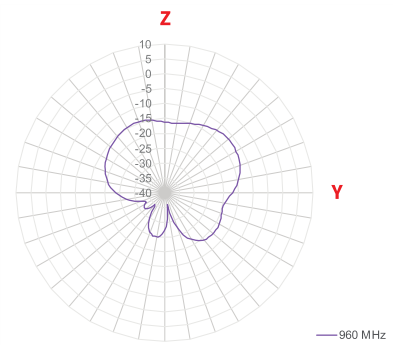
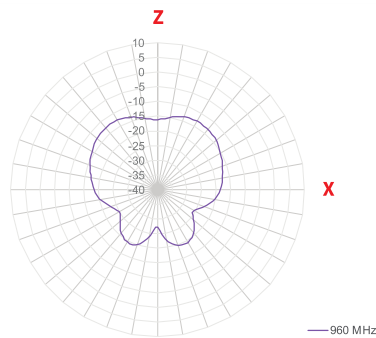
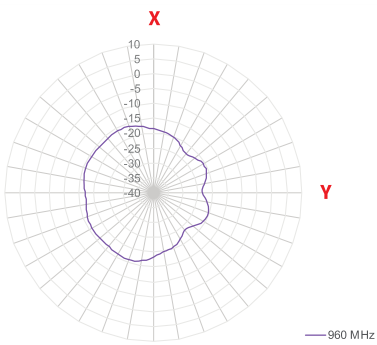

4.5 LTE 1710MHz 3D and 2D Radiation Patterns

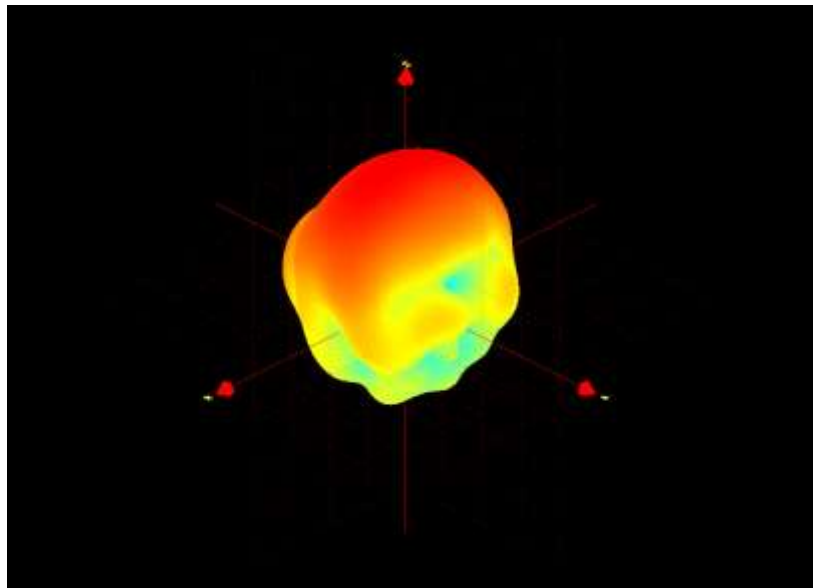

XY Plane

XZ Plane

YZ Plane

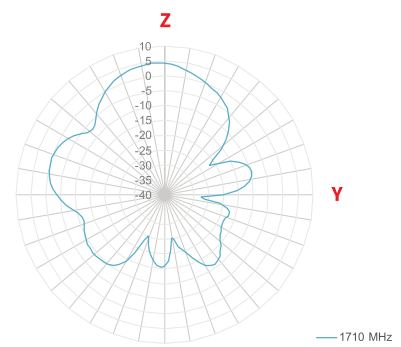
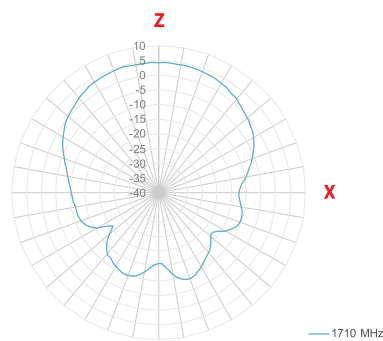
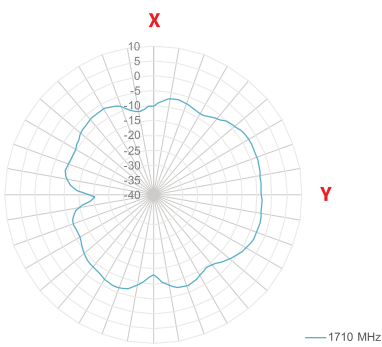

4.6 LTE 2170MHz 3D and 2D Radiation Patterns

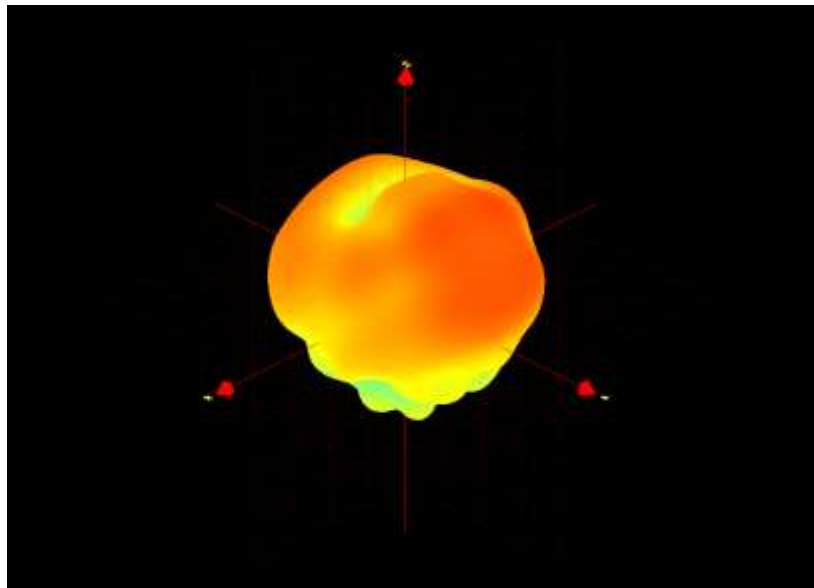

XY Plane

XZ Plane

YZ Plane

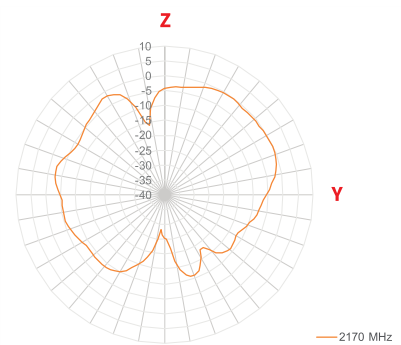
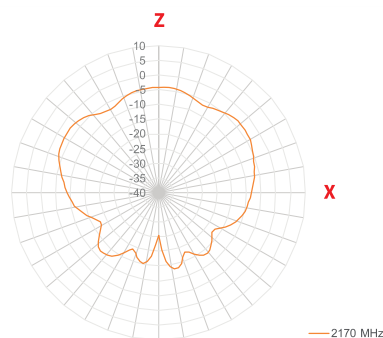
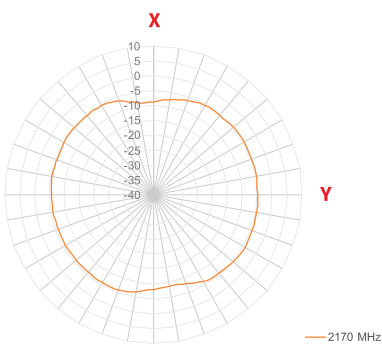

4.7 LTE 2500MHz 3D and 2D Radiation Patterns

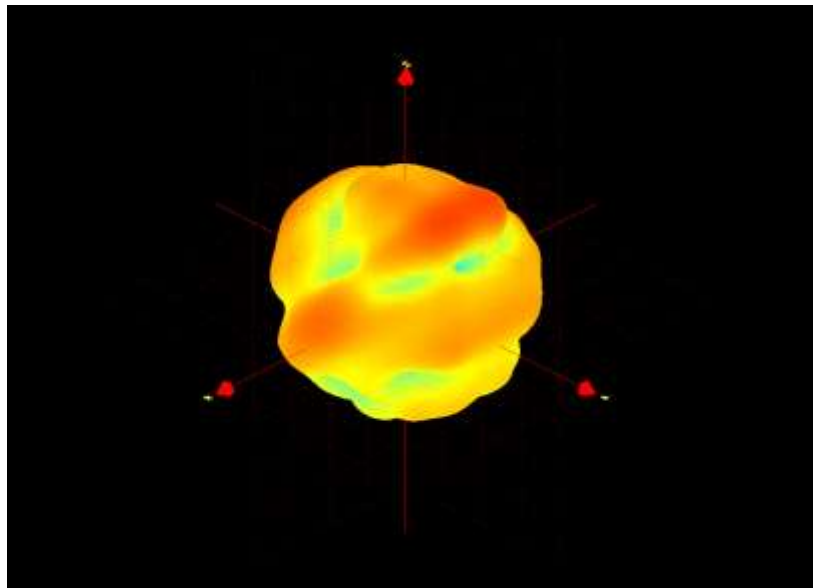

XY Plane

XZ Plane

YZ Plane

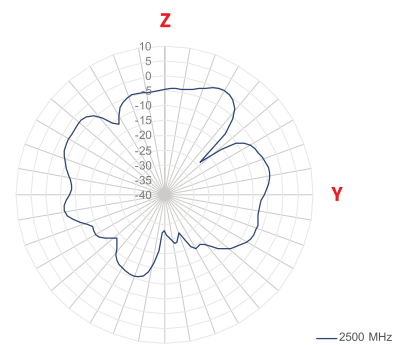
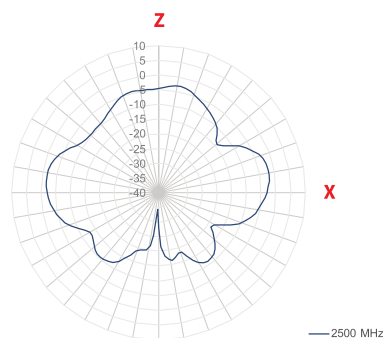
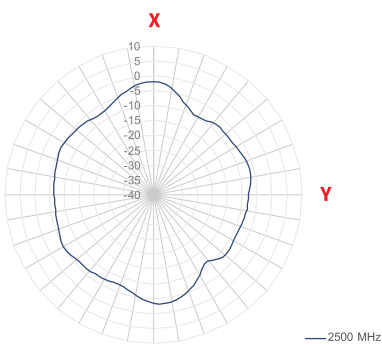

4.8 SiriusXM 2326.25MHz 3D and 2D Radiation Patterns

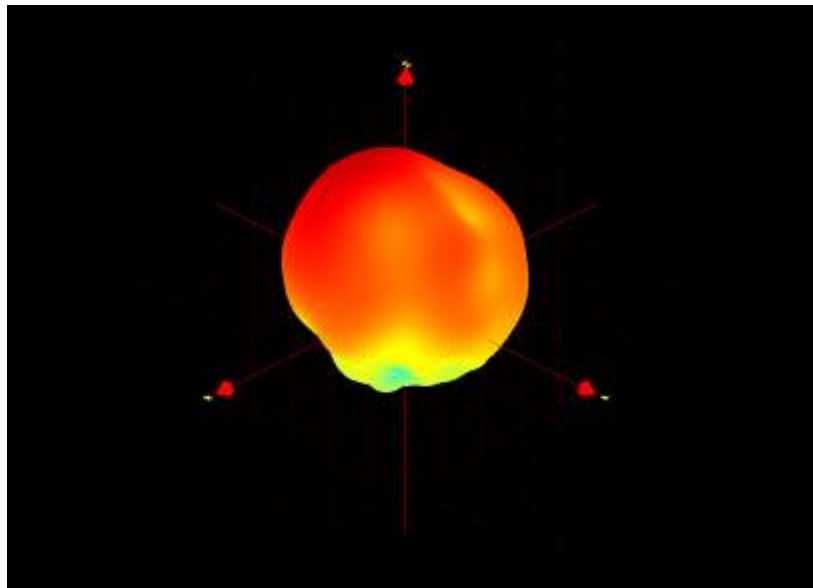

XY Plane

XZ Plane

YZ Plane

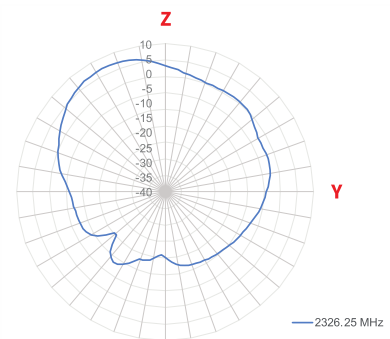
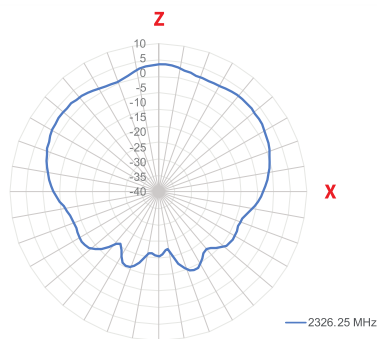
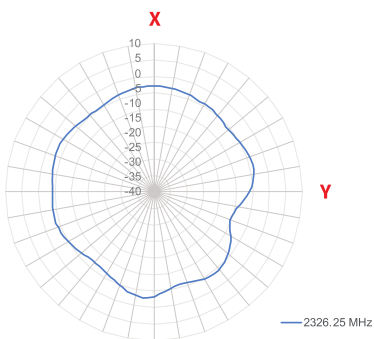

4.9 SiriusXM 2338.75MHz 3D and 2D Radiation Patterns

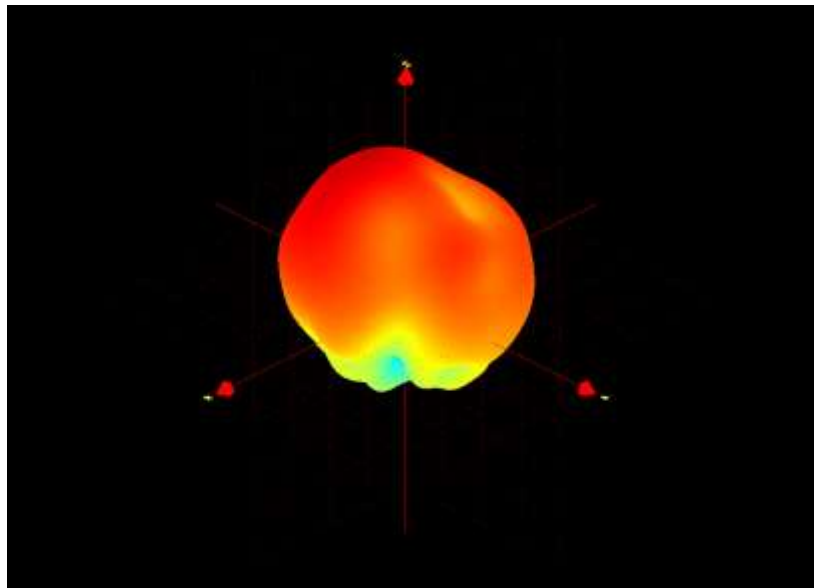

XY Plane

XZ Plane

YZ Plane

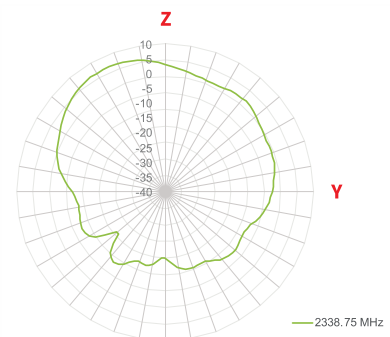
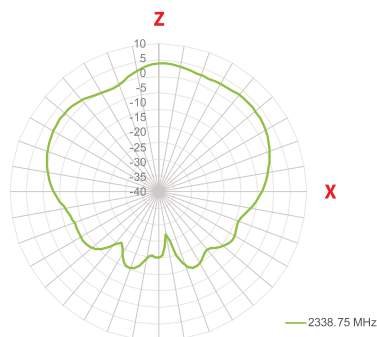
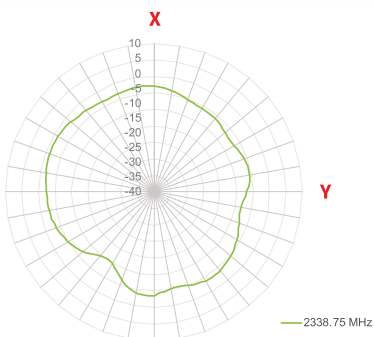

4.10 GPS(1&2) 1559MHz 3D and 2D Radiation Patterns

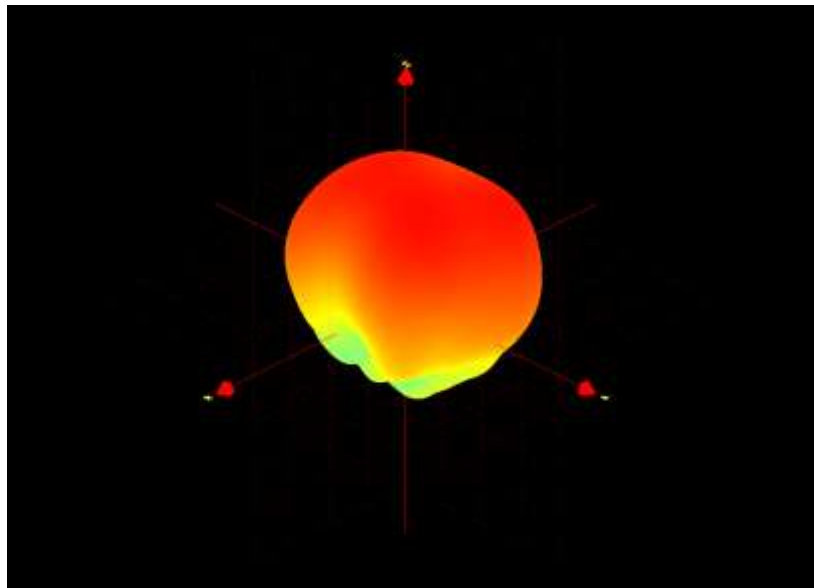

XY Plane

XZ Plane

YZ Plane

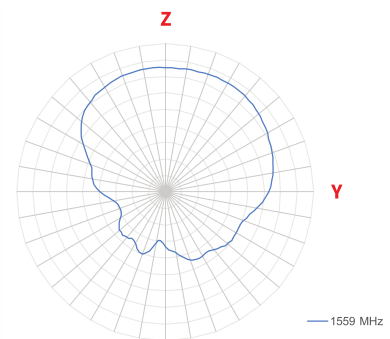
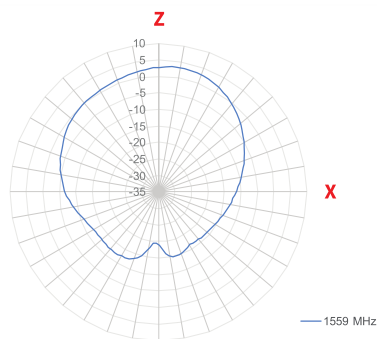
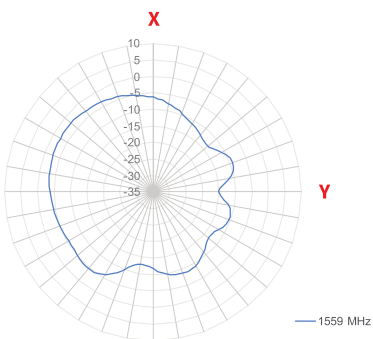

4.11 GPS(1&2) 1575.5MHz 3D and 2D Radiation Patterns

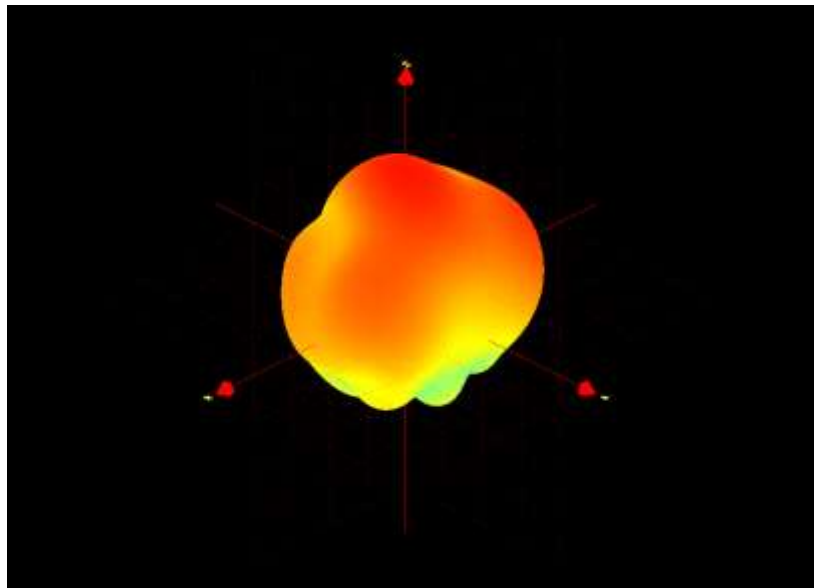

XY Plane

XZ Plane

YZ Plane

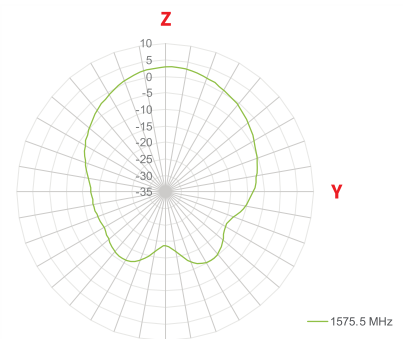
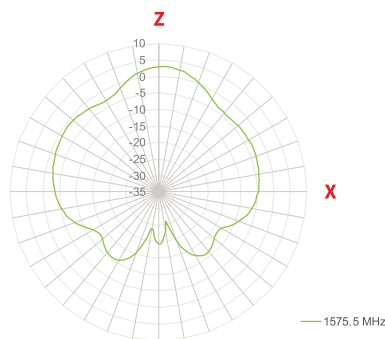
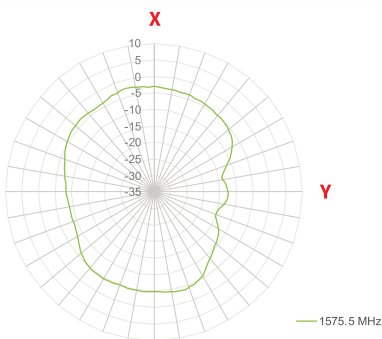

4.12 GPS(1&2) 1602MHz 3D and 2D Radiation Patterns

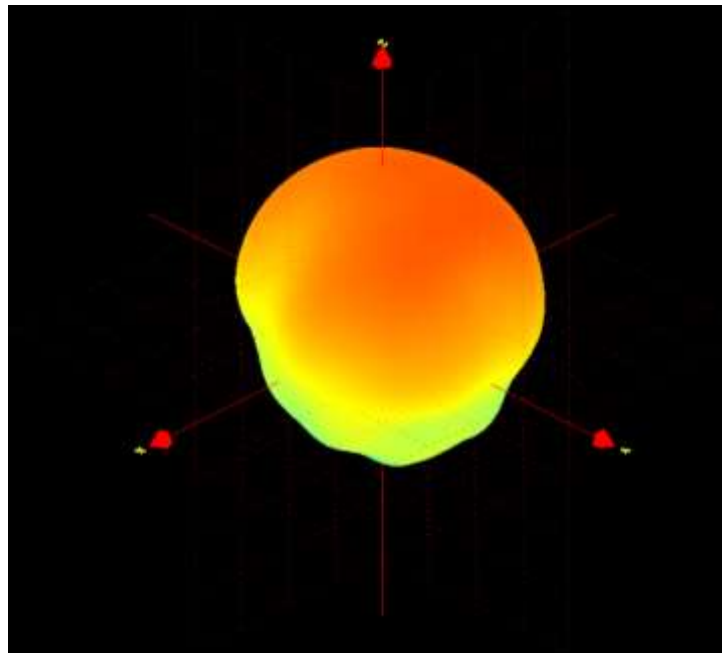

XY Plane

XZ Plane

YZ Plane

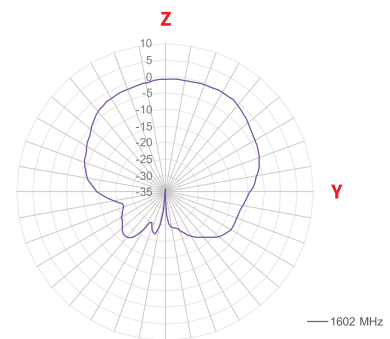
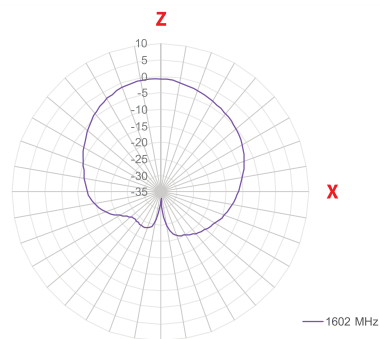
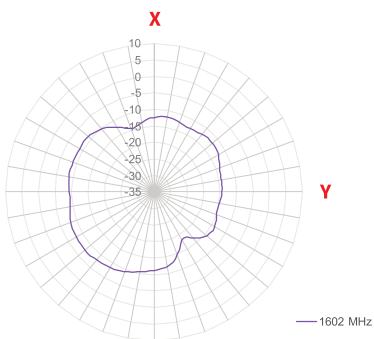

5. Mechanical Drawing (Units: mm)

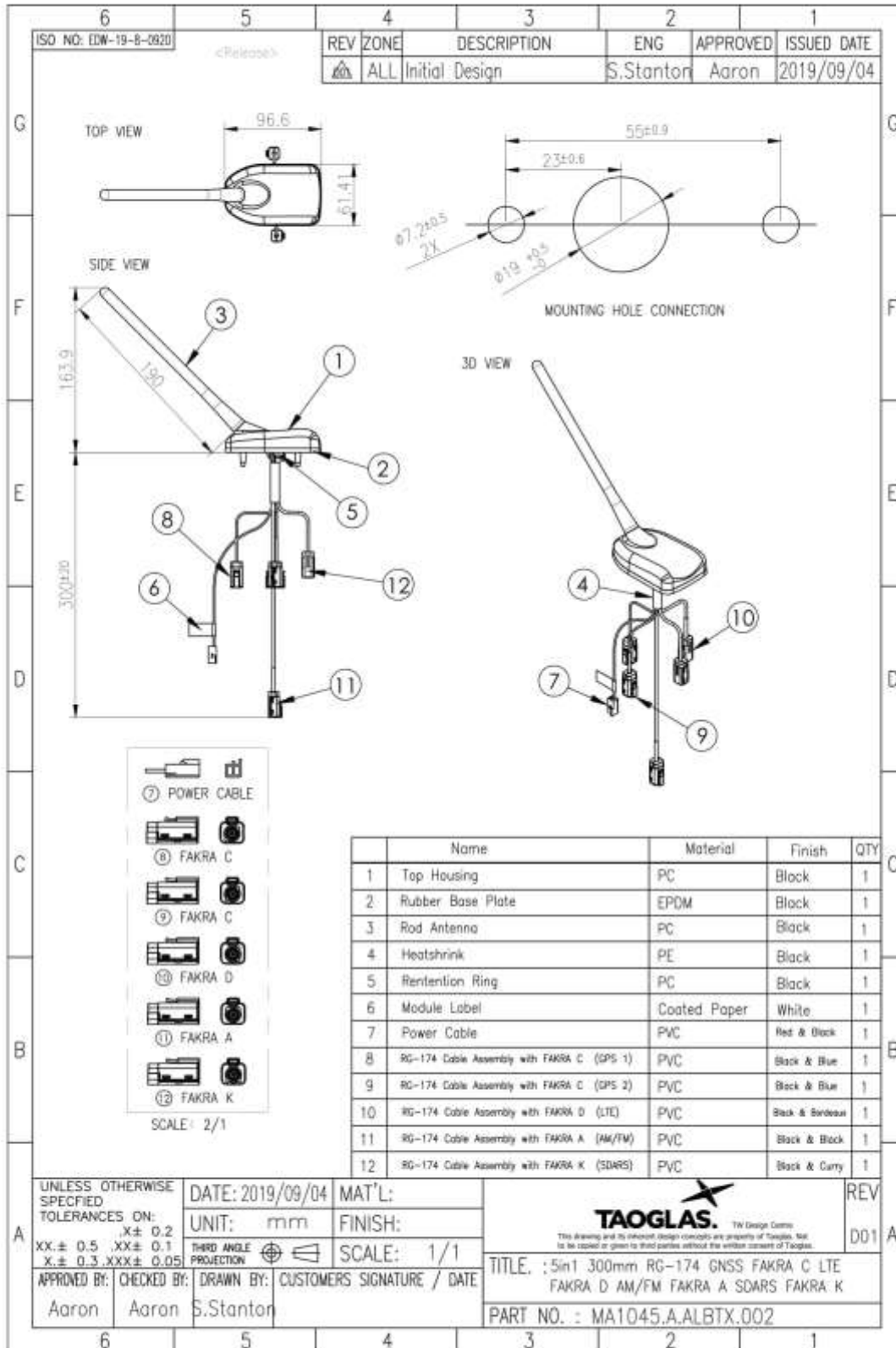

6. Packaging

1pc MA1045.A.ALBTX.002 per Bubble Bag
Weight: 230g



50pcs MA1045.A.ALBTX.002 per Carton
Dimensions: 505*300*300mm
Weight: 13.5Kg

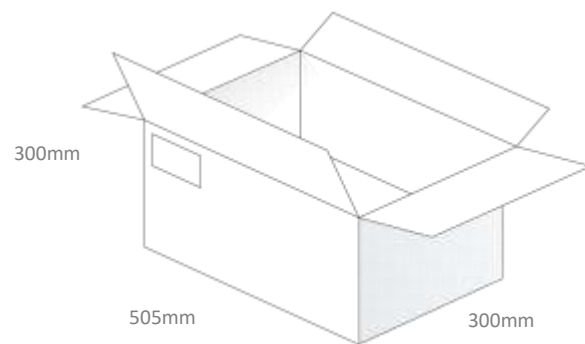

Pallet Dimensions:
1500*1000*1100mm
30 Cartons Per Pallet
6 Cartons Per Layer, 5 Layers

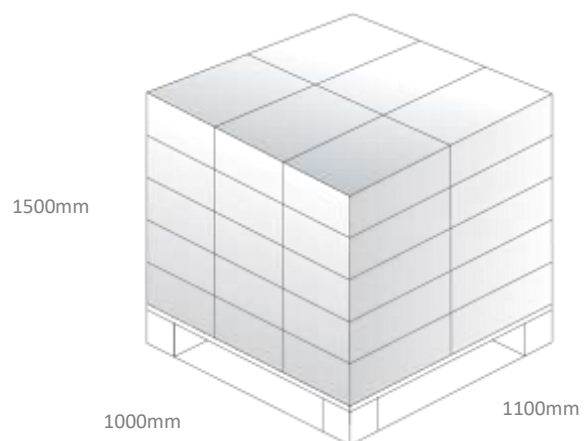

Changelog for the datasheet

SPE-19-8-095 – MA1045.A.ALBTX.002

Revision: B (Current Version)	
Date:	2020-11-30
Changes:	Certified SXM (SiriusXM)
Changes Made by:	Dan Cantwell

Previous Revisions

Revision: A (Original First Release)	
Date:	2019-08-09
Notes:	Initial Datasheet Release
Author:	Jack Conroy